

# 3. ENVIRONMENTAL SETTING, IMPACTS AND MITIGATION MEASURES

---

## 3.1 INTRODUCTION

### 3.1.1 AREAS OF ENVIRONMENTAL ANALYSIS

Chapter 3 describes the setting, impacts and mitigations for the Proposed Project, design options and alternatives of the following environmental categories:

- Soils, geology and seismicity
- Hazardous materials
- Hydrology
- Ecosystem
- Land use and economic activity
- Fremont Central Park (land use and recreation)
- Visual quality and aesthetics
- Cultural and historic resources
- Utilities and public services
- Safety and security
- Transportation
- Noise and vibration
- Air quality
- Energy

The analysis for each environmental category focuses on discussion of direct impacts (i.e. impacts that would occur once the BART extension is completed and begins operations), construction impacts, mitigation measures, residual impacts after mitigations, and any cumulative impacts. These discussions are for the Proposed Project, the eleven alternatives, and the design options (as described in Chapter 2, Project Description). As stated in the introduction to this document, the California Environmental Quality Act (CEQA) requires that the potential effects of any project be measured against the existing conditions of the project area setting. However, large public rail transit projects often take as long as ten years from the planning stages to the opening of the line for passengers. Therefore, the potential impacts from the implementation of the Warm Springs BART Extension will be compared not only to the existing conditions, but

also to the conditions which can be anticipated to occur in the year 1998, the year in which passenger service is projected to begin. In some environmental areas such as cultural resources, hydrology or geology, there will be little or no change in conditions between the present and 1998; however, in other areas such as traffic or noise, change can be anticipated and projected.

The impacts and the levels of significance of the impacts before and after mitigation for the Proposed Project, and the design options and project alternatives as detailed in this chapter are summarized in the Summary chapter of this document.

### 3.1.2 SUMMARY OF PROJECTIONS FOR CUMULATIVE ANALYSIS

The discussion of cumulative impacts as required by CEQA<sup>1</sup> will appear in each environmental section. The analysis is based on the "summary of projections" approach using the Fremont 1990 General Plan rather than a "list-based" approach where all the past, present and reasonably anticipated future projects are listed and their effects reflected in the environmental discussion.<sup>2</sup>

The City of Fremont General Plan land use projections are extrapolated from Association of Bay Area Governments (ABAG) projections.<sup>3</sup> ABAG project industrial development to more than double in the next 15 years. Manufacturing and retail and employment services will continue to expand in Fremont. However, to be conservative in infrastructure planning, the City's projections assume somewhat higher levels of employment growth than would occur with ABAG projections. The City assumed approximately 120,100 jobs would be added between 1989 and 2010. The City's residential development projections are generally consistent with ABAG's, approximately a 20 percent increase from 1989 to 2010. The number of residences is expected to increase from 60,400 in 1989 to about 72,100 units in 2010.

The demand for transportation depends on the development permitted under the General Plan and on regional and local economic conditions.

Future plans to improve air quality are considered such as a modification of the existing vehicle inspection program and the replacement of older cars with newer cars having better pollution controls. The General Plan also notes the availability of sufficient affordable housing to an expected work force, and alternative modes of transportation to the single occupant automobile,

---

<sup>1</sup> *State CEQA Guidelines*, California Administrative Code, Section 15130.

<sup>2</sup> A "list-based" approach uses a list of past, present and reasonably anticipated future projects producing related or cumulative impacts.

<sup>3</sup> City of Fremont, *Fremont General Plan*, Preliminary Draft II, March 1991, p. 3-3.

will significantly affect the degree to which air pollution from autos can be reduced in the future.

The importance of Fremont's open space to its character as a community is one of the General Plan's fundamental goals. Four projects are under consideration by the City of Fremont for future development in Central Park: gymnasium/swim center, golf course, police department building, and a cultural arts center. These four proposed projects would be consistent with the civic and recreational purposes of Central Park.

The City's General Plan has goals to protect biological resources. The City could manage land for its biological resource value, and thereby protect the City's biological heritage and its connections to its natural environment.

## 3.2 SOILS, GEOLOGY, AND SEISMICITY

### 3.2.1 SETTING AND EXISTING CONDITIONS

#### Regional Geology

The San Francisco Bay area is located within the Coast Range Geomorphic Province of California, a region shaped by complex and dynamic geologic processes. Deformation of the earth caused by the interaction of mobile crustal plates ("tectonics") has produced the northwest-trending ridges and valleys which characterize the Coast Ranges. San Francisco Bay occupies a structural depression which formed between the uplifted Diablo Range and Berkeley Hills to the east and the hills of the San Francisco Peninsula to the west.

The dominant structural feature within the region is the San Andreas Fault System. This system includes several major fault zones, including the San Andreas, Hayward, and Calaveras fault zones. The San Andreas Fault System is the seismically active crustal boundary formed as the result of northwestward movement of the Pacific plate relative to the North American plate.

#### Local Geology

The alignment of the Proposed Project is located near the eastern edge of the San Francisco Bay Plain. A break in slope to the east of the alignment forms the base of the foothills of the Diablo Range. The general physiographic features within the area have been named by the California Department of Water Resources<sup>1</sup> as shown in Figure 3.2-1.

Several geologic maps have been prepared and numerous geotechnical investigations have been completed in the area of the Proposed Project.<sup>2,3,4</sup> In general, the deposits of the area are distinguished as older and younger alluvium on the basis of geomorphic position and physical

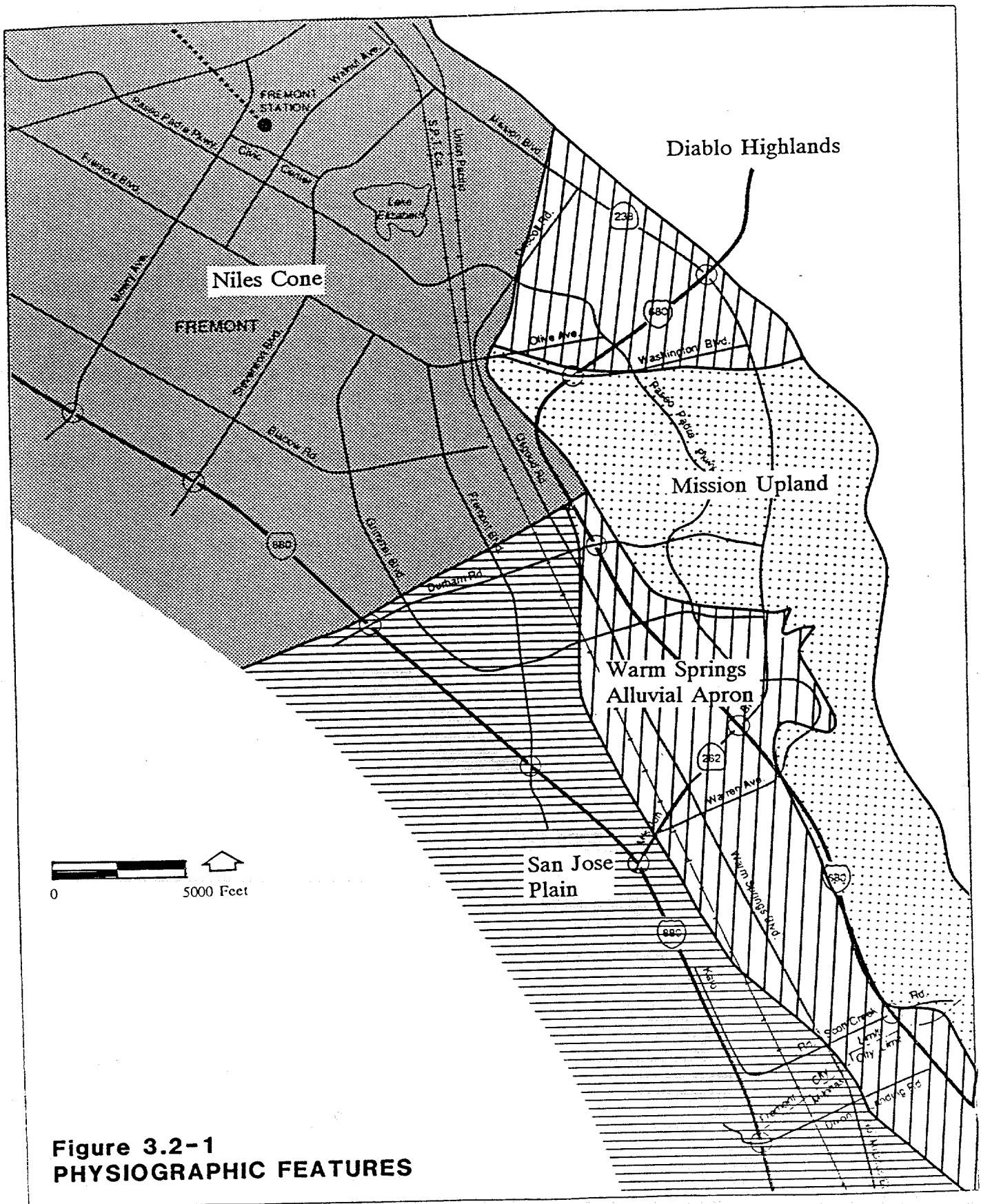
---

<sup>1</sup> California Department of Water Resources (DWR), 1967, *Evaluation of ground water resources: South Bay* (Appendix A: Geology): California Department of Water Resources Bulletin No. 118-1.

<sup>2</sup> Helley, E.J., Lajoie, K.R., Spangle, W.E., and Blair, M.L., 1979, *Flatland deposits of the San Francisco Bay region, California - their geology and engineering properties, and their importance to comprehensive planning*: U.S. Geological Survey Professional Paper 943, 88p.

<sup>3</sup> Helley, E.J., Lajoie, K.R., and Burke, D.B., 1972, *Geologic map of late Cenozoic deposits, Alameda County, California*: U.S. Geological Survey Miscellaneous Field Studies Map MF-429, scale 1:62,500.

<sup>4</sup> Dibblee, T.W. Jr., 1980, *Preliminary geologic map of the Niles quadrangle, Alameda County, California*: U.S. Geological Survey Open-File Report 80-533c, scale 1:24,000.



**Figure 3.2-1  
PHYSIOGRAPHIC FEATURES**

SOURCE: California Department of Water Resources, 1967

characteristics of the sediments.<sup>1</sup> A geologic map showing the distribution of surface deposits is presented in Figure 3.2-2.

The northern portion of the Proposed Project crosses the large alluvial fan called the Niles Cone (Qhac on Figure 3.2-2). The sediments of the surface of the Niles Cone have been mapped as younger alluvial fan and floodplain deposits.<sup>2,3</sup> These sediments are considered to be of Holocene (less than 10,000 years old) age. The sediments east and south of Lake Elizabeth have been identified as finer-grained (Qham on Figure 3.2-2) than other younger alluvium within the Niles Cone.<sup>4</sup>

The younger alluvial deposits are predominantly stiff to very stiff clay, silty clay and clayey silts with minor sand and gravel deposits. The clays of the younger alluvium are typically overconsolidated. Locally, the clays are highly plastic and expansive (high shrink-swell potential).<sup>5</sup> The younger alluvium extends from the surface to depths ranging from 10 to 40 feet and are underlain by older alluvium. In general, these materials have a moderately high susceptibility to seismic shaking<sup>6</sup> and low potential for liquefaction during a large regional earthquake.<sup>7</sup>

#### GEOLOGIC TERMS

**Alluvial deposits.** *Sediments deposited by streams.*

**Liquefaction.** *The sudden reduction of strength of saturated, poorly consolidated granular deposits as the result of increases in pore water pressure beyond some critical level. The exceedance of critical pore pressures is most often caused by seismically induced ground displacement. Loss of strength can result in settlement, slumping, and lateral spreading at the ground surface.*

**Sag pond.** *A natural depression formed along a fault as the result of surface deformation caused by movement along the fault.*

<sup>1</sup> Helley and others, 1979, op.cit.

<sup>2</sup> Helley and others, 1979, op.cit.

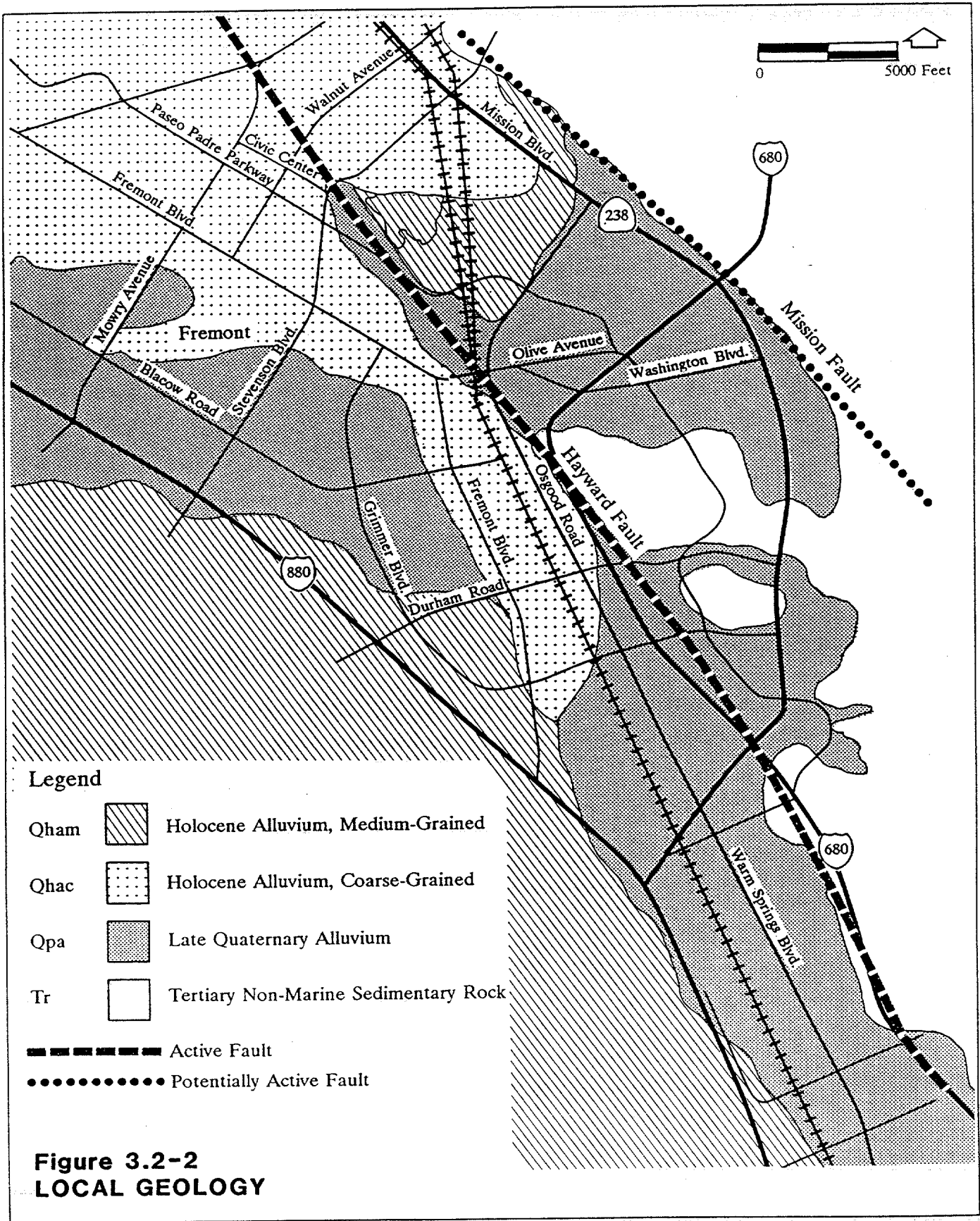
<sup>3</sup> Dibblee, 1980, op.cit.

<sup>4</sup> Helley and others, 1979, op. cit.

<sup>5</sup> Bay Area Transit Consultants (BATC), 1989, *Available Geotechnical Data Report for Warm Springs Extension*, prepared for San Francisco Bay Area Rapid Transit District, 43p + Figures, Tables and Appendices.

<sup>6</sup> Association of Bay Area Governments (ABAG), 1983, *Geologic Units in the San Francisco Bay Region*, map scale 1:250,000.

<sup>7</sup> ABAG, 1980, *Liquefaction Potential, San Francisco Bay Region*, map scale 1:250,000.



Source: Helley and Others, 1979  
 Dibblee, 1980  
 CDMG, 1980

Localized deposition of marsh deposits has occurred in shallow depressions along the Hayward Fault. The marsh deposits consist of soft to firm clay, organic clay, and peat. Due to poor consolidation and high organic content, these deposits are highly compressible. Marsh deposits have been identified within and on the margins of Tule Pond (also called Tyson's Lagoon), located north of Walnut Avenue and east of the Fremont BART Station. Previous subsurface investigations for the Fremont BART Station indicate that the marsh deposits extend to depths of 20 to 30 feet beneath the pond.<sup>1</sup> A similar "sag pond," Stivers Lagoon, was modified during construction of Lake Elizabeth. The identification of organic sediments in subsurface investigations<sup>2</sup> indicates that marsh deposits associated with this feature may be present in the area southeast of Lake Elizabeth to south of Paseo Padre Parkway. These materials have a relatively high susceptibility to groundshaking.<sup>3</sup> Although these materials are considered to have a low liquefaction potential,<sup>4</sup> localized conditions which promote liquefaction (including high groundwater levels) may be present for the marsh deposits.<sup>5</sup> Evidence of previous occurrence of liquefaction has been identified in the marsh deposits north of Tule Pond.<sup>6</sup>

From the area just south of Paseo Padre Parkway to the location of the proposed Irvington Station, the alignment traverses a portion of an unnamed older alluvial terrace. The distribution of the older alluvium (Qpa), is shown on Figure 3.2-2. These alluvial sediments consist of interbedded deposits of clays, silts, sands, and gravels which are typically at least 150 feet thick. These deposits are interpreted as being sediments deposited during the late Pleistocene (10,000 to 70,000 years old). In general, the older alluvium is more well-consolidated and contains a higher percentage of sand and gravel than the younger alluvium of the area. The older alluvium has relatively higher density and lower plasticity, and is considered to have a low susceptibility to liquefaction.<sup>7</sup>

---

<sup>1</sup> Cooper-Clark & Associates, 1975, *Soil investigation, proposed parking lot expansion and borrow source area, Fremont Station, Fremont, California*: unpublished consulting report prepared for San Francisco Bay Area Rapid Transit District, Job No. 444-F8, 5p.

<sup>2</sup> Geotechnical Engineering, Inc. (GEI), 1987, *Soil investigation, proposed residential development, Paseo Padre Parkway and Western Pacific Railroad, Tract 5580, Fremont, California*: unpublished consulting report, Job No. 110519.

<sup>3</sup> ABAG, 1983, op. cit.

<sup>4</sup> ABAG, 1980, op. cit.

<sup>5</sup> BATC, 1989, op. cit.

<sup>6</sup> Williams, J.W., Holland, P.J, Wopat, and Yeates, M., 1990, *Preliminary evidence of Hayward Fault paleoseismicity*, EOS, Vo. 71, No. 43, p.1452.

<sup>7</sup> ABAG, 1980 op. cit.



### 3.2 Soils, Geology, and Seismicity

Southward from the location of the proposed Irvington Station to near Grimmer Road, the Proposed Project alignment again crosses the surface of younger alluvium of the Niles Cone and San Jose Plains. Poorly drained areas with marsh deposits have not been identified along this portion of the alignment. However, during subsurface investigation for the Grimmer Boulevard overcrossing, layers of loose, granular sediments were encountered to a depth of approximately 30 feet.<sup>1</sup>

South of Grimmer Road to the southern terminus of the proposed alignment, the surficial geology is mapped as older alluvium of the Warm Springs Alluvial Apron. In contrast to the older alluvium exposed near Irvington Station and underlying the Niles Cone, the alluvial deposits of the Warm Springs Alluvial Apron reportedly consist of higher percentages of fine-grained, cohesive sediments.<sup>2</sup> North of Mission Boulevard, the clays and silts of the older alluvium are generally hard to very stiff with low plasticity. South of Mission Boulevard the clays are more plastic and potentially more expansive.<sup>3</sup>

#### Soils

Soil profiles have developed on the surface of the alluvial deposits of the area as a function of topography, climate, vegetation, biologic activity, the type of underlying materials and the passage of time. The surface soils along the alignment of the Proposed Project, mapped in detail by the United States Department of Agriculture Soil Conservation Service,<sup>4</sup> reflect the properties and age of the underlying alluvial deposits. In general, the surface soils of the area are cohesive clays and silty clays which have low to very low permeability, low strength, low erosion hazards, and moderate to high shrink-swell potential.

The northernmost portion of the proposed alignment, including the area of the Fremont BART Station and northern Central Park, is mantled by the soils of the Sycamore and Yolo series soils. These soils, developed on the young alluvial deposits of the Niles Cone, are silt loams with moderate permeability and moderate to high shrink-swell potential. Due to the gentle

---

<sup>1</sup> Moore and Taber, 1978, *Foundation investigation, Grimmer Boulevard underpass, Fremont, California*: unpublished report prepared for DeLeuw, Cather and Company, Job No. 376/50, 7p.

<sup>2</sup> BATC, 1989, op. cit.

<sup>3</sup> BATC, 1989, op. cit.

<sup>4</sup> U.S. Department of Agriculture (USDA), 1981, *Soil survey of Alameda County, California, western part*: Soil Conservation Service, 103p.

topography of the area, runoff is slow and the erosion hazard is slight. The soils surrounding Lake Elizabeth are more clay-like and include Willows and Clear Lake mapping units. These clays and clay loams coincide well with the mapped location of medium-grained young alluvium.<sup>1</sup> These fine-grained soils have very slow permeability, low strength and are considered highly expansive.<sup>2</sup>

The soils developed on the older alluvium along the north central portion of the alignment, between Paseo Padre Parkway and Washington Boulevard, include Tierra and Azule series loams and clay loams. These soils are typically deeply developed and moderately well drained with high shrink-swell potential, low strength and low permeability. The erosion hazard is low on gentle to flat topography but can be significant in cut slopes.

Silty clay loams of the Danville and Marvin series are found along the alignment from south of Washington Boulevard to just north of Grimmer Boulevard. Low permeability, low strength and high shrink-swell potential characterize these soils. The erosion hazard is typically slight.<sup>3</sup>

From Grimmer Road to the south end of the proposed alignment the majority of the soil is mapped as Clear Lake and Xerothents clays. The permeability of these fine-grained soils is very slow and the shrink-swell potential is considered high. Runoff is slow and there is no significant erosion hazard.<sup>4</sup>

### Slope Stability

Slope stability or, conversely, slope failure, is controlled by complex interrelated factors which include type of geologic materials, angle of the slope, and hydrologic conditions. Within the San Francisco Bay region, the majority of landslides occur on slopes steeper than 15 percent developed on unstable rock or sediments and which have evidence of previous slope failures.<sup>5</sup> Landsliding hazards are increased during sustained high precipitation periods and by strong seismic shaking during earthquakes.

---

<sup>1</sup> Helley and others, 1979, op. cit.

<sup>2</sup> USDA, 1981, op. cit.

<sup>3</sup> USDA, 1981, op. cit.

<sup>4</sup> Ibid.

<sup>5</sup> Nilsen, T.H., Wright, R.H., Vlasic, T.C. and Spangle, W.E., 1979, *Relative slope stability and land use planning in the San Francisco Bay Region, California*, U.S. Geological Survey Professional Paper 944, 96 p. + 3 plates.

The proposed and build alternative alignments are located within an area of gentle slopes and the relatively stable alluvial deposits of the Niles Cone and Warm Springs Alluvial Apron. The area along the alignment has been characterized as stable with respect to the stability of the slopes.<sup>1</sup> To the east of the proposed alignment in the area south of Washington Boulevard, the topography of the Mission Uplands is considerably steeper. The slopes developed on the older alluvial deposits of this area are considered generally stable to marginally stable. Two localized areas have been identified as landslides which are considered unstable.<sup>2</sup> The steep slopes of the foothills of the Diablo Highlands, south of Mission Boulevard and east of I-680 (approximately 2,000 feet east of the proposed alignment) are unstable. Numerous small to large landslides are observable on these slopes on aerial photographs and in field reconnaissance.

### Seismicity

The seismicity of a region is determined by distribution, recurrence, and intensity of earthquakes over a period of time in that region. Earthquakes occur as the result of the release of stored energy which can cause the rupture of brittle earth materials within and at the surface of the earth. Gradual release of the stored strain can occur as slow slippage along the fault, or "fault creep." The rupture surface along which the earth is displaced, one side relative to the other, is called a fault.

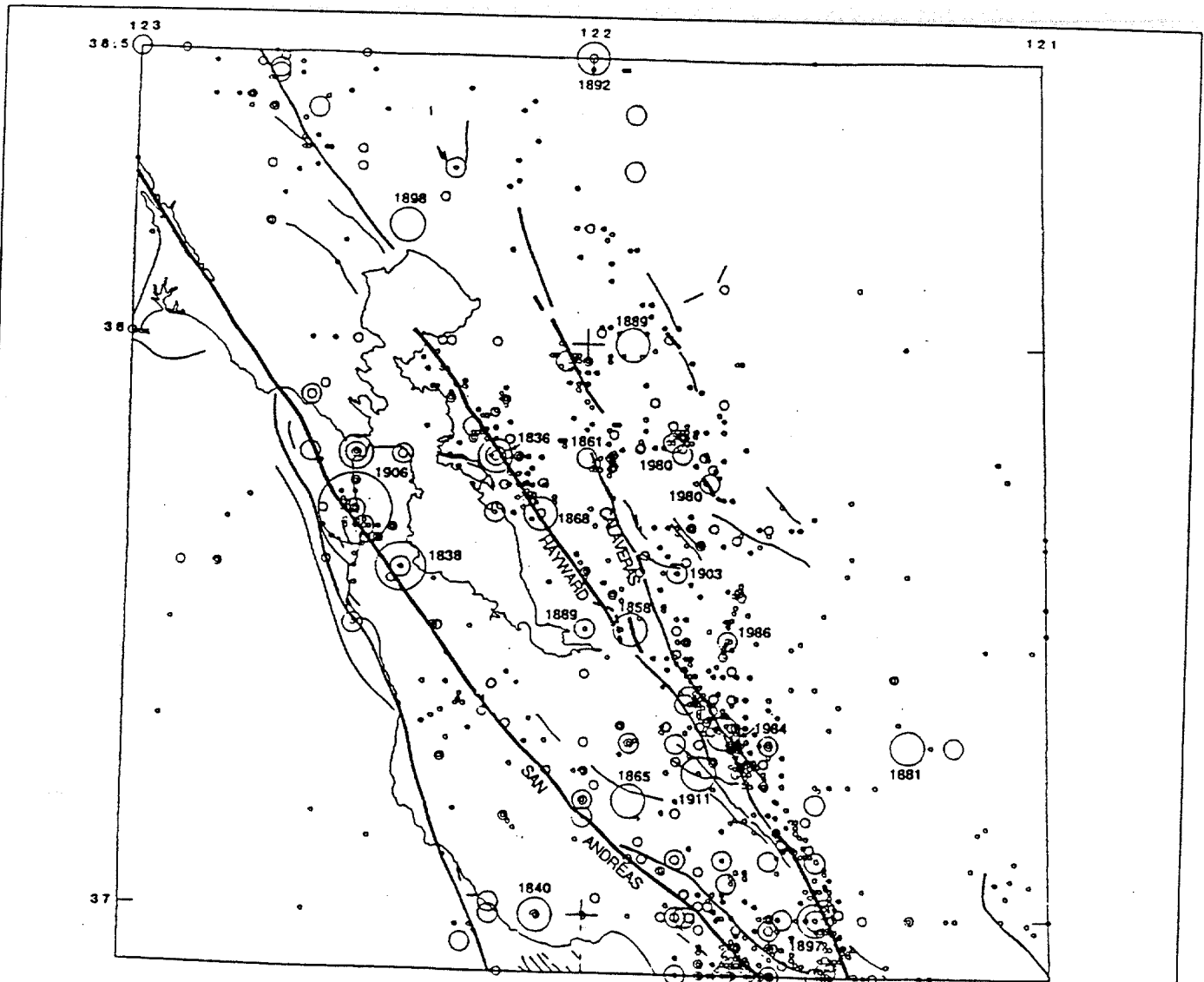
The surface expression of this displacement is referred to as a fault trace or fault line. The recognition of enduring expression of ground surface rupture is the primary source of evidence used by geologists to identify the location of faults. Many historic damaging earthquakes have not produced ground surface rupture. The distribution of moderate to strong historic earthquakes within the San Francisco Bay Area is shown in Figure 3.2-3.

The occurrence of an earthquake produces seismic waves which emanate in all directions from the origin of the earthquake, or epicenter. The seismic waves cause groundshaking which is typically strongest at the epicenter and diminishes (attenuates) as the waves move through the earth away from the source of the quake. The severity of groundshaking at any particular point is referred to as "intensity" and is a subjective measure of the effects of groundshaking on people, structures, and earth materials. Intensity is typically expressed by the Modified Mercalli

---

<sup>1</sup> Ibid.

<sup>2</sup> Nilsen, 1979, op. cit.



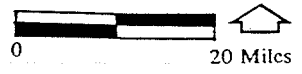
**Earthquake Magnitudes**

- 3.0 - 3.9
- 4.0 - 4.9
- 5.0 - 5.9
- 6.0 - 6.9
- 7.0 - 7.9
- > 8.0

**Faults**

- Quaternary Faults
- Major Quaternary Faults
- Historic Displacement

**Figure 3.2-3  
REGIONAL SEISMICITY**



Source: Primarily Jennings (1975), Greenville Fault, Only Historic (Jan. 1980)  
 Displacement Shown, from Bedrossian and Others (1980). For Additional Definition  
 of Greenville Fault. See CDMG SP PUB 42 (1985). BATC, 1989.

### 3.2 Soils, Geology, and Seismicity

Scale. A description of the Modified Mercalli Intensities (MMI) is presented in Table 3.2-1. The effects of ground shaking on structures depends on the design, quality of construction, and foundation materials.

Seismic waves and associated ground motion generated by earthquakes can also be detected and measured by instruments called seismographs and accelerometers. The measurement of the energy released at the point of origin, or epicenter, of an earthquake is referred to as the magnitude which is generally expressed by the Richter Magnitude Scale. The Richter Scale is logarithmic; each successively higher Richter Magnitude reflects an increase of about 31.5 times the amount of energy released by an earthquake. As such, the Richter magnitude is a specific measurement of the power of an earthquake as it occurs. The record of measurement of Richter magnitudes began in the late 1930s after seismographs were invented.

Estimates of the magnitude of earthquakes occurring prior to the development of seismographs and the Richter magnitude scale are made on the basis of historical accounts of the intensity of seismic events. The extent of damage and description of effects near and away from the source of an earthquake provides a comparison to the effects of seismic events which have been more accurately measured in recent times.

Many faults considered capable of generating damaging earthquakes have not produced seismic events during historic time, much less within the period of instrumental measurement of seismic events. The time interval between recurrence of earthquakes on many faults within California exceed the relatively short recorded history of the region. The magnitude of potential earthquakes on recognized faults is made by calculations based on the earth materials in the area of the fault and measurement or estimation of the length of the fault and previous displacements along the fault. These estimations are referred to as moment magnitudes ( $M_w$ ), and can also be calculated for modern earthquakes on the basis of seismic measurements.

The Proposed Project and BART alternatives are located within the seismically active San Francisco Bay Area. The seismicity of the San Francisco Bay Area is primarily related to the San Andreas Fault system which is considered to form the boundary between the North American and Pacific plates. The San Andreas Fault system contains several major faults and fault zones including the San Andreas Fault Zone (SAFZ) and the San Gregorio-Hosgri Fault Zone, west of San Francisco Bay, and Hayward, Calaveras, Concord, and Greenville faults in the East Bay Hills and the Diablo Range. The rate of relative motion between the North

TABLE 3.2-1  
MODIFIED MERCALLI SCALE<sup>1</sup>

Richter Magnitude Correlation	Intensity	Effects	Average Peak Ground Velocity	Average Peak Acceleration (away from the source)
3	I.	Not felt. Marginal and long-period effects of large earthquakes.		
	II.	Felt by persons at rest, on upper floors, or favorably placed.		
	III.	Felt indoors. Hanging objects swing. Vibration like passing of light trucks. Duration estimated. May not be recognized as an earthquake.		0.0035-0.007
4	IV.	Hanging objects swing. Vibration like passing of heavy trucks; or sensation of a jolt like a heavy ball striking the walls. Standing motor cars rock. Windows, dishes, doors rattle. Glasses clink. Crockery clashes. In the upper range of IV wooden walls and frame creak.		0.007-0.015
	V.	Felt outdoors; direction estimated. Sleepers wakened. Liquids disturbed, some spilled. Small unstable objects displaced or upset. Doors swing, close, open. Shutters, pictures move. Pendulum clocks stop, start, change rate.	1-3	0.015-0.035
5	VI.	Felt by all. Many frightened and run outdoors. Persons walk unsteadily. Windows, dishes, glassware broken. Knickknacks, books, etc., off shelves. Pictures off walls. Furniture moved or overturned. Weak plaster and masonry D cracked. Small bells ring (church, school). Trees, bushes shaken (visibly, or heard to rustle - CFR).	3-7	0.035-0.07
	VII.	Difficult to stand. Noticed by drivers of motor cars. Hanging objects quiver. Furniture broken. Damage to masonry D, including cracks. Weak chimneys broken at roof line. Fall of plaster, loose bricks, stones, tiles, cornices (also unbraced parapets and architectural ornaments - CFR). Some cracks in masonry C. Waves on ponds; water turbid with mud. Small slides and caving in along sand or gravel banks. Large bells ring. Concrete irrigation ditches damaged.	7-20	0.07-0.15
6	VIII.	Steering of motor cars affected. Damage to masonry C; partial collapse. Some damage to masonry B; none to masonry A. Fall of stucco and some masonry walls. Twisting, fall of chimneys, factory stacks, monuments, towers, elevated tanks. Frame houses moved on foundations if not bolted down; loose panel walls thrown out. Decayed piling broken off. Branches broken from trees. Changes in flow or temperature of springs and wells. Cracks in wet ground and on steep slopes.	20-60	0.15-0.35
	IX.	General panic. Masonry D destroyed; masonry C heavily damaged, sometimes with complete collapse; masonry B seriously damaged. (General damage to foundations - CFR.) Frame structures, if not bolted, shifted off foundations. Frames racked. Serious damage to reservoirs. Underground pipes broken. Conspicuous cracks in ground. In alluviated areas sand and mud ejected, earthquake foundations, sand craters.	60-200	0.35-0.7
7	X.	Most masonry and frame structures destroyed with their foundations. Some well-built wooden structures and bridges destroyed. Serious damage to dams, dikes, embankments. Large landslides. Water thrown on banks of canals, rivers, lakes, etc. Sand and mud shifted horizontally on beaches and flat land. Rails bent slightly.	200-500	0.7-1.2
	XI.	Rails bent greatly. Underground pipelines completely out of service.		>1.2
	XII.	Damage nearly total. Large rock masses displaced. Lines of sight and level distorted. Objects thrown into the air.		

<sup>1</sup> From Richter (1958).

**Note:** *Masonry A, B, C, D.* To avoid ambiguity of language, the quality of masonry, brick or otherwise, is specified by the following lettering (which has no connection with the conventional Class A, B, C construction).

- *Masonry A:* A Good workmanship, mortar, and design, reinforced, especially laterally, and bound together by using steel, concrete, etc; designed to resist lateral forces.
- *Masonry B:* Good workmanship and mortar, reinforced, but not designed to resist lateral forces.
- *Masonry C:* Ordinary workmanship and mortar; no extreme weaknesses such as non-tied-in corners, but masonry is neither reinforced nor designed against horizontal forces.
- *Masonry D:* Weak materials, such as adobe; poor mortar; low standards of workmanship; weak horizontally.

### 3.2 Soils, Geology, and Seismicity

American and Pacific Plates is estimated to be approximately 1.3 inches (32 millimeters)<sup>1</sup> per year. A portion of this motion is accommodated by movement along faults in the region, expressed as earthquakes and fault creep. The remainder of the motion is stored as accumulated strain, which would be released in a future earthquake. The major active and potentially active faults located within 50 miles of the Warm Springs Extension project are shown in Figure 3.2-4. These faults and their seismic potential are listed in Table 3.2-2. The table presents estimates of the moment magnitude of the largest expected earthquake generated by each of the faults. The maximum earthquake which can be reasonably expected to occur within the present geologic framework along a fault is typically referred to as the maximum credible earthquake (MCE). The probability of an earthquake occurring along a fault is a function of the estimated interval between earthquakes, and the known or estimated date of the last major earthquake.

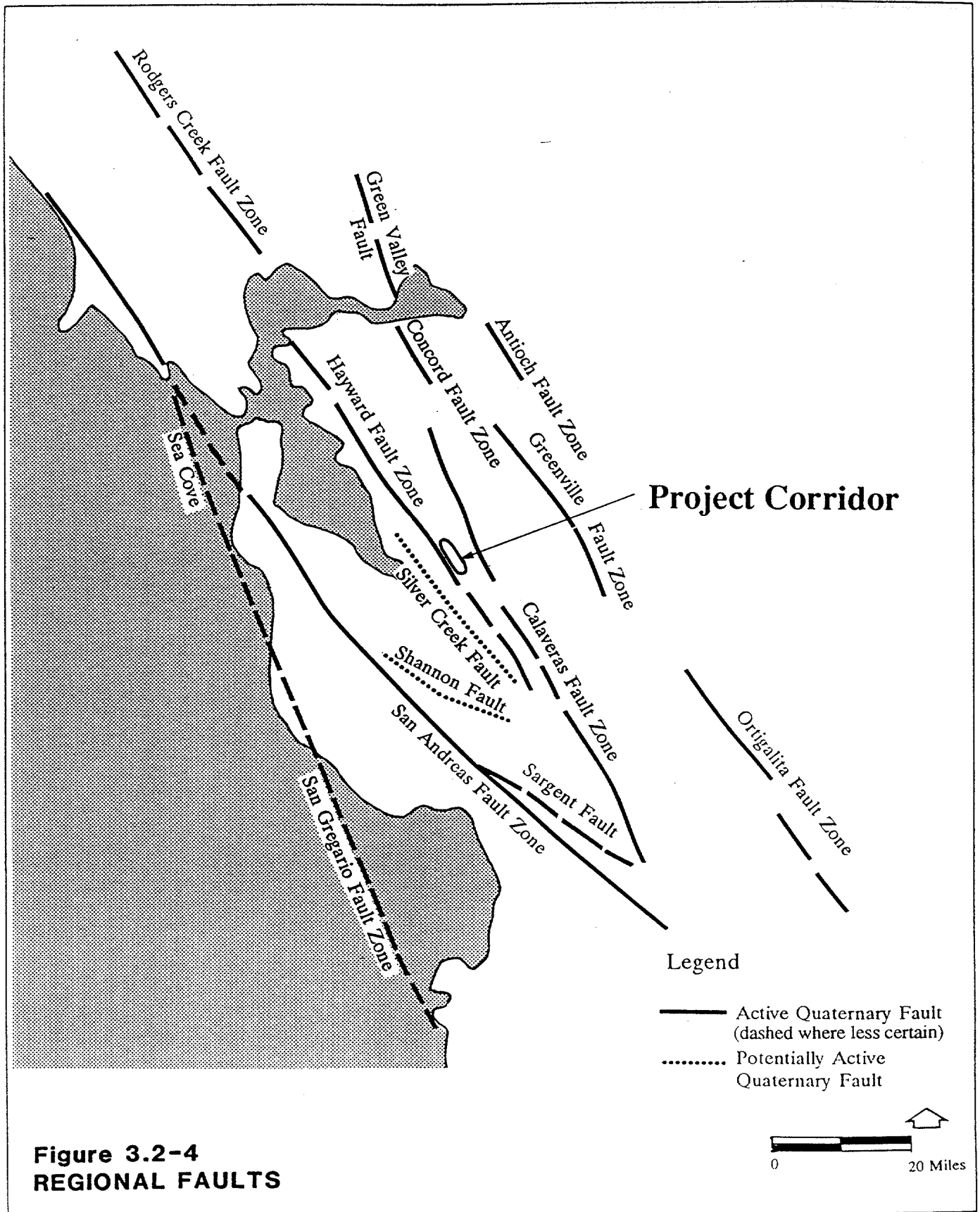
For many faults, accurate estimates of the last major earthquake has not been determined. If sufficient evidence is available, the maximum earthquake which can be reasonably expected within the next 100 years, or maximum probable earthquake (MPE) can be estimated. Estimates of the probability of maximum expected earthquakes for some of the major faults within California have been made by the United States Geological Survey (USGS) for the next 30-year period. The following section describes the characteristics of each of the recognized or suspected active and potentially active faults which may affect the project site.

**Active Faults.** The Alquist-Priolo Special Studies Zones Act of 1972 (the Act) was passed by the California legislature to reduce the hazards of surface rupture along seismically active faults within the state. Under the Act, the California Division of Mines and Geology (CDMG) was charged with identifying active faults within the state and delineating special studies zones (SSZs) in which surface rupture by faulting was probable. The CDMG defines an active fault as a fault which has evidence of surface displacement within the last 11,000 years.<sup>2</sup> Most of the recognized active faults within the San Francisco Bay Area are associated with the San Andreas Fault System (SAFS). The SAFS includes several well-studied faults and fault zones and less well-understood subsidiary faults. Each of the major regional active faults described below are considered capable of generating earthquakes which could produce moderate to violent groundshaking in the project corridor.

---

<sup>1</sup> Page, B.M., 1982, *Modes of Quaternary tectonic movement in the San Francisco Bay region*, in *Proceedings conference hazards in the eastern San Francisco Bay Area*, California Division of Mines and Geology, Special Publication 62, pp. 1-10.

<sup>2</sup> Hart, E.W., 1990, *Fault-rupture hazard zones in California*, California Division of Mines and Geology, Special Publication 42 (Revised) 26p.



**Figure 3.2-4  
REGIONAL FAULTS**

SOURCE: Baseline Environmental Consulting, 1991



**Table 3.2-2  
Major Faults Potentially Affecting  
Proposed Warm Springs Extension Project**

Fault	Distance from Project (miles)	Maximum Probable Earthquake <sup>1</sup> (M <sub>R</sub> )	Maximum Credible Earthquake <sup>2</sup> (M <sub>W</sub> )	Recurrence Interval <sup>3</sup> (years)	Years of Historic Damaging Earthquakes	Expected Maximum Peak Ground Acceleration at Site During MCE <sup>4</sup> (g)
<u>Active</u>						
Antioch	29	6.5	6.6 (6.75) <sup>2a</sup>	NA	1889?, 1965	0.09
Calaveras	5	7.25	6.3 (7.5) <sup>2b</sup>	150	1861	0.45
Green Valley-Concord	27	6.5	6.9 (6.75) <sup>2a</sup>	424	1955	0.11
Greenville	27	6.5	6.8 (7.25) <sup>2b</sup>	3585	1980	0.13
Hayward	0	7.25	7.1 (7.5) <sup>2b</sup>	264-556	1836, 1858, 1868	1.46 <sup>2e</sup>
Ortigalita	36	NA	6.7 (7.0) <sup>2a</sup>	10,000	none known	0.08
San Andreas (North Coast Segment)	17	8.5	7.8 (8.3) <sup>2c</sup>	300	1833, 1906	0.37
Sargent	36	NA	7.0	NA	none known	0.08
Seal Cove-San Gregario	29	NA	NA (8.5) <sup>2d</sup>	NA	none known	0.28

<sup>1</sup>The maximum probable earthquake (MPE) is the largest earthquake expected within the next 100 years. The source for the listed MPEs is Contra Costa County (1986).

<sup>2</sup>The maximum credible earthquake (MCE) is the largest earthquake expected under the present geologic framework. The sources for MCE estimates are Wesnousky (1986) and other higher estimates by (shown in parenthesis):

a. Mualchin and Jones, in preparation.

b. Slemmons and Chung, 1982.

c. Wesson and others, 1975.

d. Coppersmith and Griggs, 1978.

e. Bay Area Transit Consultants, 1989, a mid-run.

<sup>3</sup>Recurrence interval, or repeat time, is the estimated interval of time between maximum credible earthquakes. The source for recurrence intervals are summarized in Wesnousky (1986).

<sup>4</sup>Maximum ground accelerations estimated by magnitude-distance-acceleration curve developed by Mualchin and Jones, in preparation.

Note: NA = Not available.

**Hayward Fault Zone.** The Hayward Fault Zone (HFZ) is a right-lateral strike slip fault zone within the SAFS which extends approximately 60 miles from San Jose northwestward to Point Pinole. The fault zone is expressed by active seismicity, including large historic earthquakes, active fault creep, and abundant geomorphic evidence of fault rupture. The fault zone has been divided into the northern East Bay and the southern East Bay segments on the basis of seismicity and fault rupture history.<sup>1</sup>

Major historic earthquakes in 1836, 1858, and 1868 occurred along the HFZ. The 1836 and 1868 earthquakes are estimated to be approximate Richter magnitude 6.8 events.<sup>2</sup> Relatively little historic information is available regarding the effects of the 1836 and 1858 earthquakes. The 1836 event, centered near Oakland, produced ground rupture from San Pablo to Mission San Jose and maximum shaking of Modified Mercalli Intensity IX.<sup>3</sup> The estimated magnitude of the 1858 earthquake is Richter magnitude 6.1 on the basis of maximum reported intensities of MMI VIII.<sup>4</sup> The epicenter of the 1858 earthquake was near Warm Springs in the Fremont area.

Ground rupture was reported along the Hayward Fault from Oakland to Fremont during the 1868 earthquake.<sup>5</sup> Reportedly, a maximum of three feet of horizontal displacement along the fault was produced during this event. Approximate MMI IX groundshaking was experienced in the Fremont area during this quake.<sup>6</sup> Reported accounts of the quake

---

<sup>1</sup> Working Group on California Earthquake Probabilities, 1990, *Probabilities of large earthquakes in the San Francisco Bay Region, California*, U.S. Geological Survey Circular 1053, 51p.

<sup>2</sup> Topozada, T.R., Real, C.R., and Parke, D.L., 1981, *Preparation of isoseismal maps and summaries of reported effects for pre-1900 California earthquakes*, California Division of Mines and Geology, Open-file Report 81-11 SAC, 182 pp.

<sup>3</sup> Coffman, J.L., von Hake, C.A., and Stover, C.W., 1982, *Earthquake History of the United States*, Publication 41-1, U.S. Government Printing Office, 208pp.

<sup>4</sup> Topozada, 1981, op. cit.

<sup>5</sup> Steinbrugge, K.V., Bennett, J.H., Lagorio, H.J., Davis, J.F., Borchardt, G., Topozada, T.R., Degenkolb, H.J., Laverty, G.L., and McCarty, J.E., 1987, *Earthquake planning scenario for a magnitude 7.5 earthquake on the Hayward fault in the San Francisco Bay Area*: California Division of Mines and Geology Special Publication 78, 243p.

<sup>6</sup> Topozada, 1981, op. cit.

### 3.2 Soils, Geology, and Seismicity

describe ground rupture in the area south of Niles and significant damage to the Southern Pacific Railroad tracks in the Irvington area.<sup>1</sup>

Observation of offset cultural features and geodetic measurements across the HFZ document constant slippage along the fault. This slippage occurs along the fault at a relatively constant rate between large earthquakes and is referred to as "aseismic creep". Numerous investigations of the rate of creep have been conducted along the southern segment of HFZ in the last three decades.<sup>2,3,4,5,6</sup> A recent study of the historic slip rates along the HFZ suggests that although the fault zone has an overall average rate of 5.1 mm/yr, significant variations in the creep rate is documented.<sup>7</sup> Relatively high rates (8 to 10 mm/yr) characterize a 4-kilometer stretch of the fault in southern Fremont, including the southern portion of the Proposed Project. In the Fremont Central Park area, the creep rate is estimated to be about 6 mm/yr, consistent with local geodetic measurements and longer-term geologic and slip rates.<sup>8</sup> A region of low creep rate 3.5 to 4.0 mm/yr) has been identified in Oakland.<sup>9</sup>

---

<sup>1</sup> Lawson, A.C., 1908, *The California Earthquake of April 18, 1906, Comparison with other severe earthquakes in the same region*, Report of the State Earthquake Investigation Commission, v. 1, pp. 434-447.

<sup>2</sup> Cluff, L.S. and Steinbrugge, K.V., 1966, *Creep in the Irvington District, Fremont, California*, in *Tectonic creep in the Hayward fault zone, California*: U.S. Geological Survey Circular 525, p. 8-13.

<sup>3</sup> Bonilla, M.G. 1966, *Deformation of railroad tracks in Fremont, California*, in *Tectonic creep in the Hayward fault zone, California*: U.S. Geological Survey Circular 525, p. 6-8.

<sup>4</sup> Borchardt, G., Lienkaemper, J.J., Budding, K.E., and Schwartz, D.P., 1990, *Holocene Slip Rate of the Hayward Fault, Fremont, California*, in *Soil Development and Displacement Along the Hayward Fault*, Volume I, Chapter A, California Division of Mines and Geology Open File Report 88-12, pp. 1-52 + plates.

<sup>5</sup> Nason, R.D., 1971, *Investigation of fault creep in northern and central California*: Ph.D. thesis University California, San Diego, 231p.

<sup>6</sup> Prescott, W.H. and Lisowski, M., 1983, *Strain accumulation along the San Andreas fault system east of San Francisco Bay, California*: *Tectonophysics*, V.97, p. 41-56.

<sup>7</sup> Lienkaemper, J.J., Borchardt, G., and Lisowski, M., in preparation, *Historic creep rate and potential for seismic slip along the Hayward Fault, California*.

<sup>8</sup> Borchardt and others, 1990, op. cit.

<sup>9</sup> Lienkaemper and others, in prep., op. cit.

### 3.2 Soils, Geology, and Seismicity

The long-term slip rate of the HFZ, as measured by offset of Pliocene (six to eight million year old) volcanic rocks, has been estimated to be between 5 to 7.5 mm/yr.<sup>1,2</sup> If the more rapid creep rates measured at the surface (9 mm/yr) are assumed to represent the slip rate along the fault at depth, the reaches of the fault with lower slip rates may represent area of strain accumulation. The release of this strain could generate large earthquakes along these "locked" segments of the fault.<sup>3</sup>

In the Fremont area, the HFZ is expressed as a prominent structural feature with an abundant evidence of surface deformation. Linear fault scarps, pressure ridges, and tectonic depressions characterize a well-defined western fault trace. Accurate location of the western trace has been identified by numerous trenching investigations conducted in the area between the Fremont BART Station and Washington Boulevard. The locations of trenching investigations, showing the identified position of the fault, is presented in Figure 3.2-5. In addition to the fault trenching studies, aseismic creep along the fault has resulted in observable displacement of man-made features including pavements and curbs,<sup>4,5,6</sup> a warehouse facility north of Washington Boulevard<sup>7</sup> and the former Fremont Community Center in Central Park.<sup>8</sup> The observable deformation along the western trace is typically restricted to a narrow zone of less than 50 feet in width. On the basis of the substantial body of evidence collected to date, the western trace is considered to be mapped with a moderate to high confidence through this area.<sup>9,10</sup>

---

<sup>1</sup> Fox, K.F., Jr., Fleck, R.J., Curtis, G.H. Meyer, E.C., 1985, *Implications of the northwestwardly younger age of the volcanic rocks of west-central California*: Geological Society of America Bulletin, v. 96, p. 647-654.

<sup>2</sup> Sarna-Wojcicki, A.M., Meyer, C.E., and Slate, J.L., 1986, *Displacement of a ca. 6 Ma tuff across the San Andreas fault system, northern California*: EOS, v. 67, no. 44, p.1224.

<sup>3</sup> Lienkaemper and others, in prep., op. cit.

<sup>4</sup> Nason, 1971, op. cit.

<sup>5</sup> Earth Systems Consultants, 1986, *Soil and geologic study, proposed townhouse project - Tract 5639, Fremont, California*: unpublished consulting report, File No. C6-1987-C1, 32p.

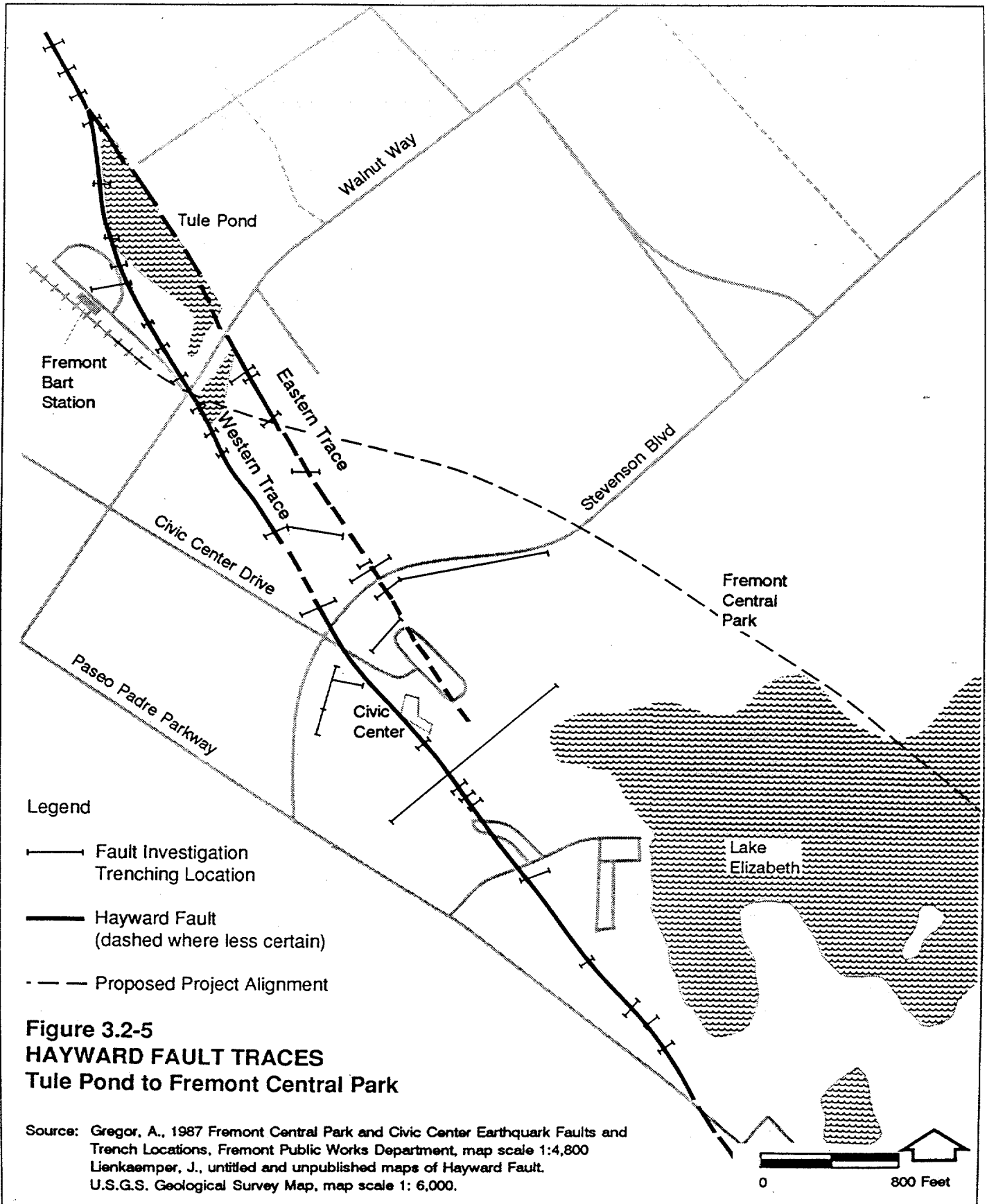
<sup>6</sup> Lienkaemper and others, in prep., op. cit.

<sup>7</sup> Cluff and Steinbrugge, 1966, op. cit.

<sup>8</sup> Burkland and Associates, 1978, *Geologic and seismic hazards investigation, Community Center Building Addition, Fremont, California*, unpublished consulting report.

<sup>9</sup> BATC, 1989, op. cit.

<sup>10</sup> Borchardt and others, 1990, op. cit.



### 3.2 Soils, Geology, and Seismicity

The Proposed Project is located near the center of the southern East Bay segment of the fault zone. The fault zone trends northwest-southeast, crossing the northern portion of the proposed alignment just south of Walnut Avenue and again at Washington Boulevard. Southward from Washington Boulevard, the orientation of the fault and the alignment diverge, separated by a distance of 3,600 feet at the southern end of the alignment (Figure 3.2-2).

A subsidiary trace of the HFZ has been mapped subparallel to and east of the western trace. The eastern trace is mapped as extending southward from its merging with the western trace just north of Tule Pond to just south of the intersection of Mission View Drive and Paseo Padre Parkway (Figure 3.2-5).<sup>1</sup> Unlike the western trace, the eastern trace is not expressed by prominent geomorphic features associated with faulting. Trenching across the eastern trace in the area east of Tule Pond revealed minor offsets of young sediments.<sup>2</sup> At the south end of the pond, no evidence of fault rupture was observed in trenches across the mapped fault trace.

Deformation in this area was expressed as low amplitude folding of the sediments. The lack of identifiable subsurface and geomorphic expression of a fault in this area has been interpreted as evidence that the eastern trace is no longer active.<sup>3,4</sup>

Recent studies of the eastern trace near the north end of Tule Pond indicates repeated faulting during the last 2,000 years.<sup>5,6</sup> Recent investigation of the eastern trace uncovered evidence of fault rupture (including sediment displacements and deformation) in trenches excavated across the eastern trace south of Stevenson Boulevard, northeast of the Fremont

---

<sup>1</sup> California Division of Mines and Geology (CDMG), 1980, Niles quadrangle: State of California Special Studies Zones, revised official map, scale 1:24,000.

<sup>2</sup> Woodward-Clyde and Associates, 1970, *Fremont Meadows active fault investigation and evaluation, Fremont, California*: Oakland, California, unpublished consulting report prepared for F.B. Burns and Associates, Project No. G-10396, 62p.

<sup>3</sup> Ibid.

<sup>4</sup> Borchardt and others, 1990, op. cit.

<sup>5</sup> Williams, P.L., 1991, *Evidence of late Holocene ruptures, south Hayward Fault, California*, Geological Society of America, Abst. with Programs, Vol. 23, No. 2, p.109.

<sup>6</sup> Williams and others, 1990, op. cit.

Civic Center.<sup>1</sup> A recent study of the microseismicity of the area suggests that a previously unidentified trace of the Hayward Fault zone may exist between the Hayward Fault and the base of the foothills to the east.<sup>2</sup> Evidence of faulting or fault-related deformation was not identified in extensive trenches excavated east of and perpendicular to the eastern trace during investigations for the California School of the Blind<sup>3</sup> and within Central Park.<sup>4</sup>

The Hayward Fault zone is considered capable of producing the next major earthquake in the San Francisco Bay Area. Estimates of the maximum credible earthquakes on the Northern Bay and southern East Bay segments of the Hayward Fault zone range from magnitude 6.8 to 7.3.<sup>5</sup> Based on the possibility of the entire fault zone rupturing in a single event, it has been suggested that a maximum credible earthquake of magnitude 7.5 may occur.<sup>6</sup> It has been estimated that the maximum expected earthquake on the fault segment parallel to the Proposed Project may be moment magnitude 7.1.<sup>7</sup> The estimated probabilities for earthquakes of magnitude 7.0 in the next 30 years on the north and south segments of HFZ are 28 and 23 percent, respectively.<sup>8</sup>

**San Andreas Fault Zone.** The San Andreas Fault Zone (SAFZ), a complex right-lateral strike slip fault zone, extends over more than 600 miles from the Gulf of California in Mexico to Cape Mendocino in northern California. The SAFZ has been divided into discrete segments on the basis of historic seismicity and evidence of ground surface

---

<sup>1</sup> GEI, 1990a, *Report Fault Location Study including preliminary soil investigation, planned new Police Building east of existing Civic Center, Fremont, California*, prepared for the City of Fremont, 28p. + Appendices.

<sup>2</sup> Wong, I.G., Hemphill-Haley, and Wright, D.H. 1991, *What and where is the Mission Fault in the eastern San Francisco Bay Area, California?*, Seismological Research Letters, Vol. 62, No. 1, p.51.

<sup>3</sup> Lockwood-Singh and Associates, 1984, *Geotechnical site investigation, fault and liquefaction study, California School for the Blind, Fremont, California*: unpublished consulting report, Project Ref. 3126-42.

<sup>4</sup> GEI, 1990a, op. cit.

<sup>5</sup> Slemmons, D.B., and Chung, D.H., 1982, *Maximum credible earthquake magnitudes for the Calaveras and Hayward fault zones, California, in Proceedings conference on earthquake hazards in the eastern San Francisco Bay Area, California Division of Mines and Geology, Special Publication 62*, pp.115-124.

<sup>6</sup> Steinbrugge and others, 1987, op. cit.

<sup>7</sup> Wesnousky, 1986, op. cit.

<sup>8</sup> Working Group on California Earthquake Probabilities, 1990, op. cit.

### 3.2 Soils, Geology, and Seismicity

rupture.<sup>1</sup> Segments of the SAFZ capable of generating earthquakes which could affect the project site include the North Coast segment, the San Francisco Peninsula segment, and the southern Santa Cruz Mountains segment. The SAFZ is located approximately 17 miles southwest of the Proposed Project.

The 1906 San Francisco earthquake, a Richter magnitude 8.3 event, resulted in rupture of all of these segments and produced intense ground shaking (MMI-VII to X) in the Fremont area.<sup>2</sup> The USGS estimates the probability of a MCE of Richter magnitude 8 on the North Coast segment of the fault within the next 30 years to be two percent.<sup>3</sup> The Richter magnitude 7.1 Loma Prieta earthquake in 1989 occurred along the southern Santa Cruz Mountain segment and produced MMI VI in the area of the project site.<sup>4</sup> The probability of a similar earthquake on this segment in the next 30 years is estimated to be less than one percent. The San Francisco segment of the SAFZ is expected to produce a MCE of Richter magnitude 7, with a probability of 37 percent, within the next 30 years.<sup>5</sup>

Considering the distance of the project site from the SAFZ, the estimated peak ground acceleration produced at the site during the expected magnitude 8.3 MCE would be 0.37g. The expected maximum MMI associated with this event would be VIII to IX.

**Calaveras Fault Zone.** The Calaveras Fault Zone (CFZ) is located east of the HFZ at a distance of approximately five miles east of the project corridor. This right-lateral strike slip system extends approximately 100 miles northwestward from Hollister as a complex zone of faulting. Recorded seismicity in the vicinity of the fault includes more than 50 earthquakes of MMI of V or greater in the period 1930 to 1972. Historic earthquakes greater than Richter magnitude 6 include events in 1897, 1911 and 1979. Estimates of the maximum expected earthquake for this fault zone range from Richter magnitude 6.3 to 7.5.<sup>6,7</sup> The range of expected events reflects the potential for events on discrete

---

<sup>1</sup> Ibid.

<sup>2</sup> Lawson, 1908, op. cit

<sup>3</sup> Working Group on California Earthquake Probabilities, 1990, op. cit.

<sup>4</sup> U.S. Geological Survey, 1989, *Lessons Learned from the Loma Prieta, California Earthquake of October 17, 1989*, G. Plafker and J.P. Galloway, editors, U.S. Geological Survey Circular 1045, 48p.

<sup>5</sup> Working Group on California Earthquake Probabilities, 1990, op. cit.

<sup>6</sup> Slemmons and Chung, 1982, op. cit.



### 3.2 Soils, Geology, and Seismicity

segments of the fault zone and possible rupture of the entire zone. Using the higher estimate for the MCE, the expected peak acceleration at the site would be 0.45g with associated MMI IX effects.

**Seal Cove-San Gregorio-Hosgri Fault Zone.** The Seal Cove-San Gregorio-Hosgri Fault zone (SC-SG-HFZ) forms a belt of faulting and seismicity located west of and subparallel to the San Andreas Fault Zone. Although the majority of the fault zone's nearly 240-mile length lies offshore, the San Gregorio segment of the zone offsets late Quaternary deposits in the Pigeon Point area north of Santa Cruz. A maximum credible earthquake of Richter magnitude 7 has been estimated for the San Gregorio segment.<sup>1</sup> Rupture of the entire length of the SC-SG-HFZ could potentially generate an earthquake of magnitude 8.5.<sup>2</sup> The fault zone lies approximately 29 miles west of the project site. A maximum event could produce 0.28g ground acceleration at the site and MMI intensity VIII shaking.

**Sargent Fault.** The Sargent fault forms the southwest boundary of a broad belt of southwest-dipping thrust and high-angle reverse fault on the eastern flank of the southern Santa Cruz Mountains, east of the San Andreas Fault Zone (SAFZ). Evidence of Late Pleistocene and possibly Holocene displacement and high microseismicity have been identified for the SAFZ. The southern portion of the Sargent Fault has been assigned an Alquist-Priolo Special Studies Zone. The maximum credible earthquake on the Sargent Fault is estimated to be Moment magnitude 7.1 on the basis of fault length and estimated slip rate. The recognized active portion of the fault is located approximately 30 miles southwest of the project site. The estimated groundshaking at the project site associated with a maximum event on the Sargent Fault would be approximately 0.08g.

**Greenville Fault Zone.** The Greenville Fault Zone (GFZ) has been interpreted as being the easternmost of the major branches of the SAFS. The GFZ is a 90-mile long system of northwest trending fault segments which include the Clayton, Marsh Creek, Greenville, and Arroyo Mocho segments. Historic seismicity within the GFZ includes a swarm of

---

<sup>7</sup> Wesnousky, 1986, op. cit.

<sup>1</sup> Greensfelder, R.W., 1974, *Maximum credible rock acceleration from earthquakes in California*, California Division of Mines and Geology, map sheet 23, 1:250,000 scale.

<sup>2</sup> Coppersmith, K.J. and Griggs, C.B., 1978, *Morphology, recent activity, and seismicity of the San Gregorio Fault Zone*, in *San Gregorio-Hosgri Fault Zone, California*, eds. E.A. Silver and W.R. Normark, California Division of Mines and Geology, Special Report 137, pp. 33-43.

### 3.2 Soils, Geology, and Seismicity

earthquakes in January 1980 which included Richter magnitude 5.5 and 5.8 events. The relationship of the GFZ to several faults considered to be potentially active, including the Telsa, Corral Hollow, Carnegie, and Patterson Pass Faults, is not well studied.

Estimates of the MCE for the Greenville Fault Zone range from moment magnitude 6.8 to 7.25.<sup>1</sup> The occurrence of a magnitude 7 earthquake on this fault, located approximately 27 miles east of the project site, would generate ground acceleration of approximately 0.13g. The associated MMI could be as high as VIII.

**Green Valley-Concord Fault Zone.** The Green Valley and Concord Faults are the primary faults of a two-mile wide complex fault zone located approximately 27 miles east of the project site. The fault zone extends from east of Benicia to east of Walnut Creek. Active seismicity and fault creep (noted in Concord) have been attributed to the zone.<sup>2</sup> Historic seismicity in the fault zone include a Richter magnitude 5.4 event in 1955. A swarm of earthquakes in 1989, centered near Alamo, appears to have occurred on a fault between the Concord and Calaveras faults, suggesting a link between the two major fault zones.<sup>3</sup> The estimated MCE for the Green Valley Fault and Concord Faults is estimated to be Mw 7.<sup>4</sup>

#### Potentially Active and Inactive Faults

Numerous potentially active faults have been identified within the San Francisco Bay area. The potentially active faults significant to the assessment of seismic risks in the Fremont area include the Silver Creek, Mission, and Shannon faults.

The Silver Creek Fault has been mapped subparallel to and west of the Hayward Fault. Although suspected as having recent activity, the fault is not identified on the Alquist-Priolo Special Studies Zone maps.

---

<sup>1</sup> Wesnousky, 1986, op. cit.

<sup>2</sup> Ellsworth, W.L., Olson, J.A., Shijo, L.N., and Marks, S.M., 1982, *Seismicity and active faults in the eastern San Francisco Bay region*, in *Proceedings conference on earthquake hazards in the eastern San Francisco Bay Area*, California Division of Mines and Geology, Special Publication 62, pp.83-91.

<sup>3</sup> Oppenheimer, D.H. and MacGregor-Scott, N.G., 1991, *Seismic potential of the east San Francisco Bay region of California*, Geological Society of America, *Abst. with Prog.*, Vol. 23, No. 2, p.85.

<sup>4</sup> Wesnousky, 1986, op. cit.

## 3.2 Soils, Geology, and Seismicity

The Mission Fault is mapped at the base of the foothills east of the northern portion of the project alignment (Figure 3.2-2).<sup>1</sup> This fault was initially identified as active and a Special Studies Zone was delineated along the fault trace in 1974. However, sufficient evidence of activity was not established and the Special Studies Zoning for the fault was removed on a revised Special Studies Zone map in 1980. A linear trend of microseismicity has been identified which has been interpreted as coinciding with the subsurface projection of the Mission Fault.<sup>2</sup> A recent interpretation of the microseismicity of the area suggests that the seismicity is located about one mile west of the Mission Fault and may represent a previously unidentified branch of the Hayward Fault zone.<sup>3</sup>

The Shannon Fault, located about 14 miles southwest of the project site, forms a 29-mile long, northwest-trending topographic and structural boundary extending from Coyote to the Los Altos Hills. Possible Quaternary displacement and clusters of seismicity have been identified along the fault.<sup>4</sup> A maximum expected earthquake on the Shannon Fault has not been established.

### 3.2.2 IMPACTS OF PROPOSED PROJECT

#### Direct Impacts

Under CEQA, exposure of people or structures to major geologic hazards is considered a significant adverse impact.<sup>5</sup> Geologic hazards include the effects of earthquakes. Major seismic hazards potentially affecting the Proposed Project include fault rupture or fault creep along the HFZ and strong groundshaking with associated ground failure phenomenon during a large earthquake on the HFZ or SAFZ. The effects of these seismic hazards could include potential human injury or loss of life and substantial damage to Proposed Project structures and significant adverse impacts under CEQA.

---

<sup>1</sup> Dibblee, 1980, op. cit.

<sup>2</sup> Ellsworth and others, 1982, op. cit.

<sup>3</sup> Wong and Hemphill-Haley, 1991, op. cit.

<sup>4</sup> Rodgers, T.H., and Williams, J.W., 1974, *Potential seismic hazards in Santa Clara County, California*, California Division of Mines and Geology, Special Report 107, 39p.

<sup>5</sup> California Office of Planning and Research, 1986, CEQA: California Environmental Quality Act, Statutes and Guidelines, Appendix G, p. 284.

### 3.2 Soils, Geology, and Seismicity

Other geologic hazards potentially affecting the integrity of structures proposed by the project include compressible and expansive soils. In general, potential damage caused by these adverse soil conditions would not be catastrophic but may result in significant structural damage. The possible effects of the adverse soil conditions on the Proposed Project and alternatives to the project are significant impacts to this type of construction project if not avoided or mitigated.

**Fault Rupture.** Potential ground surface rupture during a large earthquake on the southern East Bay segment of the Hayward Fault Zone (HFZ) could result in risk of injury to persons on or near the proposed Warm Springs extension alignment and potential damage to the proposed structures. This would be a significant impact. The Proposed Project's alignment crosses the HFZ just south of Walnut Avenue. The alignment trends southwestward from the existing Fremont BART Station and traverses the western fault trace approximately 500 feet from the station (Figure 3.2-5). The western trace in this area has been identified by two series of trenches excavated for earlier development projects.<sup>1,2</sup> The extension alignment transects the fault at an angle of about 30 degrees.

Approximately 890 feet southeast of the intersection with the western fault trace, the Proposed Project alignment crosses the projected trace of the eastern branch of the Hayward Fault (Figure 3.2-5). Although the closest previous trenching investigation of the eastern trace did not identify evidence of the fault trace,<sup>3</sup> evidence of faulting on the east trace has been identified north and south of this location.<sup>4,5</sup>

The Proposed Project alignment also crosses the HFZ north of the alignment intersection with Washington Boulevard (Figure 3.2-6). The location of the fault trace in this area is less well-documented than at the Walnut Avenue crossing. The proposed Irvington Station platform is located approximately 520 feet south of this fault trace crossing. The northwest-southeast trending fault trace is mapped approximately 200 feet east of the north end of the proposed station. The fault would pass through the proposed parking facility for the station.

---

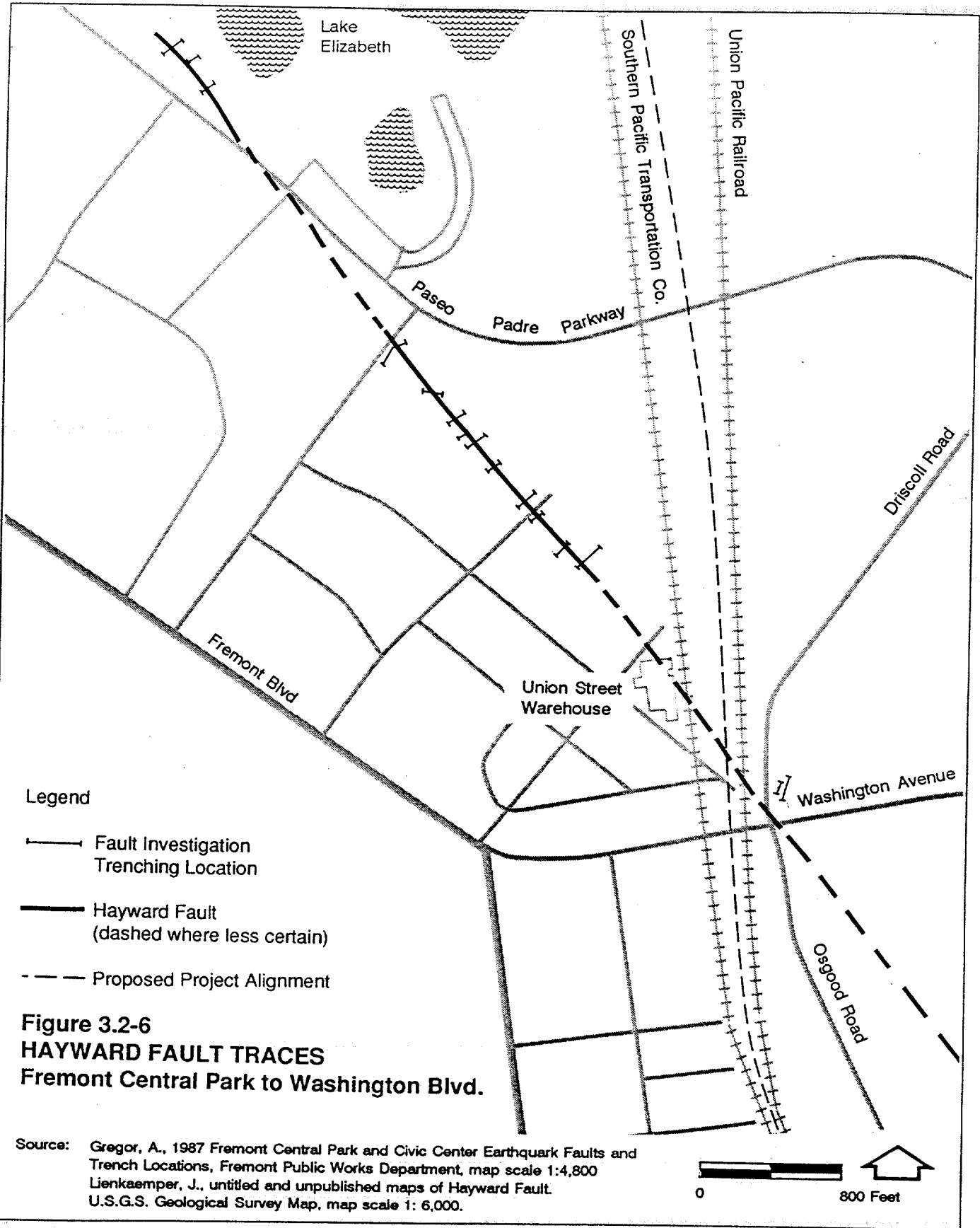
<sup>1</sup> Woodward-Clyde Associates, op. cit.

<sup>2</sup> Cooper-Clark and Associates, 1968, op. cit.

<sup>3</sup> Earth Systems Consultants, 1985, *Geotechnical report, Niles School Site Development, Fremont, California*: unpublished consulting report prepared for Fremont Unified School District, Fremont, File No. C5-1684-C1, 43pp.

<sup>4</sup> Woodward-Clyde Associates, 1970, op. cit.

<sup>5</sup> Alt, 1991, op. cit.



**Figure 3.2-6**  
**HAYWARD FAULT TRACES**  
**Fremont Central Park to Washington Blvd.**

Source: Gregor, A., 1987 Fremont Central Park and Civic Center Earthquake Faults and Trench Locations, Fremont Public Works Department, map scale 1:4,800  
 Lienkaemper, J., untitled and unpublished maps of Hayward Fault.  
 U.S.G.S. Geological Survey Map, map scale 1: 6,000.

A moment-magnitude 7.0 earthquake is expected to occur within the next 30 years on the southern East Bay segment of the HFZ. This seismic event would be similar in magnitude to the earthquake which occurred in 1868. During the 1868 earthquake, a maximum of three feet of horizontal and three feet of vertical surface displacement was reported along the fault. For the purpose of planning for the effect of a maximum credible earthquake ( $M_w$  7.5) during which the northern and southern segments of the HFZ rupture, a maximum right-lateral horizontal displacement of ten feet has been

suggested.<sup>1</sup> The estimated average horizontal displacement would be approximately half of the maximum. An evaluation of potential fault rupture, prepared for a development project at the north end of the proposed alignment estimated a maximum credible offset of up to seven feet horizontal and up to 1.5 feet vertical. The total displacement is expected to be distributed within a zone 10 to 20 feet wide.<sup>2</sup> Structures located within this zone are likely to sustain significant damage including displacement or rotation of rigid elements.

Evidence of previous surface displacement, both vertical and horizontal, has been identified on both the western and eastern traces of the fault. Secondary faulting within the fault zone at the northern end of the alignment is not expected to extend more than about 200 feet away from the known fault trace nor produce displacements of more than a few inches.<sup>3</sup> The expected displacements along secondary fault could cause minor repairable damage to rigid structures.

The impacts of fault rupture would include potential damage to the rails crossing the western and eastern traces of the fault and displacement of pavements planned for the Irvington station. Impacts could occur to trains passing on the tracks; during weekday peak hours, one train

#### ABBREVIATIONS

APSSZ	<i>Alquist-Priolo Special Studies Zone</i>
CDMG	<i>California Division of Mines and Geology</i>
CFZ	<i>Calaveras Fault Zone</i>
GFZ	<i>Greenville Fault Zone</i>
HFZ	<i>Hayward Fault Zone</i>
MCE	<i>Maximum Credible Earthquake</i>
MMI	<i>Modified Mercalli Scale</i>
MPE	<i>Maximum Probable Earthquake</i>
$M_R$	<i>Richter Magnitude</i>
$M_w$	<i>Moment Magnitude</i>
NPDES	<i>National Pollution Discharge Elimination System</i>
SAFZ	<i>San Andreas Fault Zone</i>
UBC	<i>Uniform Building Code</i>

<sup>1</sup> Steinbrugge and others, 1987, op. cit.

<sup>2</sup> Woodward-Clyde Associates, 1970, op. cit.

<sup>3</sup> Ibid.

### 3.2 Soils, Geology, and Seismicity

traverses the tracks about every 2.25 minutes, and every 4.5 minutes during the off-peak hours. Although the fault trace is mapped approximately 200 feet east of the northern end of the Irvington station, the exact location of the main fault trace and possible secondary faults have not been identified by subsurface investigation at the proposed station site.

The subway portions of Design Options 1 and 2S do not cross the fault trace. Since fault rupture is restricted to areas along the fault, there is no potential for fault rupture impact on the subway structure.

**Mitigation of Fault Rupture.** The design of the Proposed Project includes construction of a 1,650-foot long earthen embankment beginning at the Fremont station. This embankment would be constructed across the western and eastern traces of the fault zone. In general, embankments are more tolerant of differential movement expected along the fault than more rigid structures that could be constructed to support the elevated track at these locations.<sup>1</sup> The embankment design would be prepared in accordance with the BART Extensions Program Design Criteria, Volume II, 1990, and specific recommendations developed for the fault crossing near Walnut Avenue.<sup>2</sup> The design criteria established for the Walnut Avenue crossing include a 54-foot crest width to accommodate track realignment due to fault offset or creep, 2:1 side slopes and removal of unstable foundation materials. Although this design criteria for embankment structures will reduce potential damage and will facilitate repair in the event of fault rupture, the impacts of fault rupture would remain significant.

Where the Proposed Project alignment crosses the fault approximately 320 feet north of Washington Boulevard, it would be located within a cut approximately 20 feet below the ground surface. The cut slopes would be constructed at two horizontal to one vertical inclination in compliance with BART seismic design criteria. The UPRR and SPTCo tracks would be lowered below existing grade and separated by retaining walls. The retaining walls would also be designed according to BART seismic design criteria. This design criteria will minimize damage and facilitate repair in the event of seismic shaking, but the impacts of seismic shaking would remain significant.

The proposed Irvington Station is within the Alquist-Priolo Special Studies Zone established for the HFZ. If the adopted project includes an Irvington station, it would then be appropriate,

---

<sup>1</sup> BATC, 1989, op. cit.

<sup>2</sup> BATC, 1989, op. cit.

### 3.2 Soils, Geology, and Seismicity

prior to final design, to investigate the site of the station to identify the specific location of the Hayward Fault and any secondary faults. The investigation would follow the California Division of Mines and Geology guidelines for evaluating the hazard of surface fault rupture. A site-specific investigation also would address the potential for liquefaction or other seismically induced ground failures. If fault traces are identified, structures which would be occupied by workers or passengers would be located or relocated outside the zone of potential fault rupture. (The typical recommended minimum setback from an identified fault is 50 feet and 100 feet from an inferred or suspected fault trace.<sup>1</sup>) If the fault trace were 50 feet from the platform or platform/parking area, the station would need to be relocated. A station platform outside of the area identified as potentially affected by fault rupture would reduce, to below a level of significance, the risk of damage to the station structure caused by rupture. Damage to the parking area would still be expected. Although no practical mitigation is available to prevent damage to the parking area during a fault rupture event, the pavements could be repaired quickly following such an event and is a less than significant impact.

The potential of derailment of a passing train following a ground rupture event would be partially mitigated by implementation of redundant emergency response measures of the BART Emergency Plan. Groundshaking during the expected MCE would set off alarms controlled by strong motion recorders operated by BART. Seven strong motion sensors are currently operated throughout the BART system and sensor installations are proposed for each passenger station within BART extension projects.<sup>2</sup> The strong motion sensor alarms trigger an operation procedure which prescribes that all trains proceed in manual operation at a maximum speed of 25 miles per hour to the nearest station. The trains are held at the stations until a complete inspection of the tracks and structures throughout the area affected by a seismic event is completed by the BART engineering staff and subcontractors. If fault rupture or seismically-induced ground failures result in rupture of the track, power is automatically cut off to trains in the affected area. Alternatively, a power outage caused by disruption of Pacific Gas and Electric service would shut off power to the trains.

The seismic design criteria and emergency procedures would not reduce the potential impacts of surface rupture where the tracks cross the fault traces to an insignificant level. The maximum expected horizontal displacement of ten feet would likely cause significant

---

<sup>1</sup> Blair, M.L. and Spangle, W.E., 1979, *Seismic safety and land-use planning -- selected examples from California*, U.S. Geological Survey 941-B, 81p.

<sup>2</sup> Fleisher, W.B., Bay Area Rapid Transit District, 10 April 1991, personal communication.



### 3.2 Soils, Geology, and Seismicity

displacement of the tracks. Displacement of the tracks could result in derailment of passing trains causing risks of personal injury and damage to equipment.

The probability of such an event is the combined probability of a rupture event and passage of a train over the ruptured section of track. The probability of a magnitude 7.0 earthquake (considered capable of causing fault rupture at the ground surface) on the southern East Bay segment within the period 1990 to 2020 is estimated to be 0.23.<sup>1</sup> The probability of a train passing any of the three identified alignment crossings of the HFZ is a function of trip frequency, train length and train speed. Assuming 84,280 trips per year, an average train length of 5 cars (350 ft.) and a train speed of 38 miles per hour, the probability of a train passing across the three fault zones with assumed width of 200 feet is estimated to be 0.08. The combined probability of an earthquake event occurring while a train is within the fault zone is approximately 0.02, or a 1-in-50 chance.

**Fault Creep.** Active fault creep has been monitored along the HFZ in the area of the Proposed Project alignment. The creep occurs between earthquakes within the Fremont area at a rate of between five and eight mm/yr (0.2 to 0.3 in/yr.)<sup>2</sup> The rate of creep can vary along a fault both with respect to location and time. Accelerated creep is expected after a large earthquake (afterslip).

This phenomenon is expected to continue throughout the life of the project. The continued, incremental horizontal displacement of the ground surface along the HFZ has resulted in significant cracking and deformation of buildings near Washington Boulevard ("Union Street" warehouse), in Fremont Central Park, and several pavement displacements.

Over the last 30 to 40 years, rail deformation has been observed along the UPRR tracks near Shinn Road, and on the SPTCo tracks near Washington Boulevard. Special heavy equipment is used by the railroad companies to periodically realign the tracks. The realignment procedures tend to spread the deformation over a long (few hundred feet) distance of track. Based on measurements of displacement along the SPTCo tracks at the fault crossing north of Washington Boulevard and at the "Union Street" warehouse, the creep rate in this area is estimated to be greater than 8.5 mm/yr. (0.3 in/yr.) The rate of creep at the north end of the proposed alignment, including the fault crossing south of Walnut Avenue, is expected to be about 5.3

---

<sup>1</sup> Working Group on California Earthquake Probabilities, 1990, op. cit.

<sup>2</sup> Lienkaemper and others, in preparation, op. cit.

### 3.2 Soils, Geology, and Seismicity

mm/yr. (0.2 in/yr.), consistent with measurements made within Fremont Central Park and at Shinn Road to the north<sup>1</sup>. There is not sufficient data available to determine if active creep is occurring along both the western and eastern traces of fault in this area. Conservatively, both traces would be expected to experience active creep.

Active creep on the western and eastern traces of the HFZ could result in incremental displacement and deformation of the proposed trackway at the proposed alignment crossing of the HFZ. The cumulative deformation of the tracks could present safety hazards, particularly for trains operating at high speeds. If not corrected by realignment, the deformation of the track caused by fault creep could result in train derailment, a significant impact.

The subway portions of Design Options 1 and 2S do not cross the fault trace. Since fault creep is restricted to areas along the fault, there is no potential for fault creep impact on the subway structure.

**Mitigation of Fault Creep.** The potential impact of fault creep along the proposed alignment can be mitigated below a significant level by implementation of BART's track maintenance program. The detection of incremental rail displacements would be performed by periodic track and structure inspection, track alignment surveys, and reports of adverse track conditions by train operators. Accelerated creep also would be identified by these procedures.

Track inspections are currently conducted throughout the BART system on a weekly schedule by a professional maintenance staff. These inspections would identify loosened track pins and evidence of potential metal fatigue caused by deformation associated with creep. Track alignment surveys would be conducted semiannually by BART survey crews to evaluate when track alignment displacements are approaching tolerance levels established by BART. Measurement of track displacements would also be performed monthly by a specially designed "laser geometry car" currently used by BART to monitor track conditions at the Berkeley Hills tunnel, the location of an existing track-crossing of the HFZ. All monitoring of track displacements would be documented and compiled in a file maintained by BART surveying staff. In addition to regular track alignment inspection, reports by BART train operators of suspected track conditions which adversely affect train performance would be evaluated by immediate inspection of affected sections of track.

---

<sup>1</sup> Ibid.

### 3.2 Soils, Geology, and Seismicity

Repairs to or realignment of the track would be made immediately to reduce the potential of train derailments. These measures would not decrease the potential for creep along the HFZ, but would reduce the impact of creep-related deformation to below a level of significance. Another possible mitigation measure is that trackways can be designed to accommodate fault creep. As an example, the present BART line through the Berkeley Hills will allow some repositioning of the tracks when necessary because of the creep along the Hayward Fault.

**Groundshaking.** The expected maximum credible earthquake on the HFZ would cause severe to violent groundshaking throughout the area of the proposed extension alignment. Because the Proposed Project alignment crosses the fault, the project would be considered to be at the epicentral location of the MCE. Estimates for the near-field (close to the epicenter) horizontal ground accelerations during the MCE range between 0.55g and 0.87g along the extension alignment. The probability of exceedance of this estimated range of expected accelerations is 10 percent.<sup>1</sup> Groundshaking at the Fremont Civic Center during the MCE is estimated to be between 0.6 and 0.7g.<sup>2</sup> These accelerations could produce MMI X or greater. Steinbrugge and others<sup>3</sup> point out that intensities greater than MMI IX are attributed to the secondary effects of ground breakage, not shaking alone. The impact of the expected ground shaking on the structures proposed by the project could be severe if the structures were not properly designed, and would be a significant impact.

The Proposed Project and Design Options 2A and 3 include aerial track spans from the southeast end of a proposed fill and overpass over Walnut Avenue and Stevenson Boulevard through Central Park and over Paseo Padre Parkway. Aerial structures are also proposed over Grimmer Road and Mission Boulevard and with a design option over Warren Avenue. The aerial structures would be supported by five-foot diameter hexagonal reinforced concrete columns of variable height. The Paseo Padre Design Option involves an overpass for the roadway, with the BART alignment at grade.

The response of structures to strong groundshaking is dependent on the foundation materials and structural design. The susceptibility of the earth materials along the proposed alignments

---

<sup>1</sup> BATC, 1989, op. cit.

<sup>2</sup> Geotechnical Engineering Inc. (GEI), 1990b, *Phase II Geotechnical Consultation, Evaluation of seismic risk and site-specific ground motion acceleration response spectra considering near field effects existing City government and police buildings, Fremont, California*, prepared for the City of Fremont, 28p. + Appendices.

<sup>3</sup> Steinbrugge and others, 1987, op. cit.

to failure during seismic shaking is variable. The silty sand layers within marsh deposits in the vicinity of Tule Pond and Lake Elizabeth would have a moderate to high potential for liquefaction. Evidence of previous occurrence of liquefaction has been identified in the sediments at the north end of Tule Pond.<sup>1</sup> Similar sediments may be present in Central Park around Lake Elizabeth. Young alluvial sediments of the Niles Cone may also contain saturated, poorly consolidated granular sediments. Such deposits were identified in Central Park at shallow depths and considered to have a moderate liquefaction potential on the basis of their density.<sup>2</sup> The dense, older alluvial deposits in the area of the proposed Irvington station are expected to have a low susceptibility to ground failure during seismic shaking. South of the Irvington station, the sediments of the Niles Cone are traversed by the Extension alignment. Liquefaction-induced lateral spreading may have occurred along the Southern Pacific Railroad tracks south of the Irvington District during the 1906 San Francisco earthquake. As discussed above, these sediments would be considered to have a moderate susceptibility to ground failure during a major earthquake on the HFZ. Although the older alluvium of the Warm Springs Aprons along the southern portion of the alignment would generally have a low susceptibility to ground failure, young sediments along creeks may have higher susceptibility.

The subway structure proposed in Design Options 1 and 2S could also be adversely affected by strong groundshaking and liquefaction. Differential settlement along the tunnel in response to liquefaction or tectonic settlement could result in significant trackway deflections or displacements. Such effects could impact train operation. Cracking of the subway structure could cause significant groundwater seepage into the subway tunnel.

**Mitigation of Seismic Shaking and Associated Potential Ground Failure.** All structures proposed for the Proposed Project would be designed and constructed in accordance with the BART Extensions Program Design Criteria<sup>3</sup>. The design criteria were revised in 1990, following the 1989 Loma Prieta earthquake; they require specific design procedures to evaluate the seismic loading caused by 0.7 g horizontal ground acceleration generated by the MCE on the HFZ. The design criteria consider the properties of the soil expected or known to be encountered at the location of each design element.

---

<sup>1</sup> Williams, 1991, op. cit.

<sup>2</sup> GEI, 1990a, op. cit.

<sup>3</sup> BATC, 1990, *BART Extension Program Design Criteria*, Volume II, Structural, 88 p.

### 3.2 Soils, Geology, and Seismicity

All aerial structures would be supported on piles driven into dense older alluvium. Earth pressures, including seismic loading, would be determined for all retaining walls and subsurface structures (including the subway structure proposed for Design Options 1 and 2S) by the Mononobe-Okabe method as specified in the BART Design Criteria. The seismic design of all concrete structures would also conform with the provisions of the American Concrete Institute's Building Code requirements. All buildings would be designed and constructed in accordance with the 1988 Uniform Building Code including State of California 1989 Amendments.

The Proposed Project's alignment is in close proximity to the HFZ, which is considered possible of generating a major seismic event. Therefore, should an event occur within the fault zone, the implementation of the Proposed Project could result in increased exposure of people, including BART workers and passengers, to the risk of injury related to structural damage or derailment of trains caused by seismic shaking hazards. The entire urbanized area surrounding the Proposed Project corridor is subject to similar seismic hazards. Appropriate emergency planning, safety procedures, and public education can reduce the impacts of these risks to an insignificant level. BART has developed specific safety procedures for BART workers and passengers in the event of a large earthquake. The procedures for reducing potential train derailment have been described earlier. BART posts instructions for earthquake emergency procedures at each station and in BART train cars. Train operators have been trained to respond to potential emergencies related to a large earthquake. Public address systems in the stations and trains allow BART personnel to communicate specific instructions to passengers in the event of an emergency.

Strong groundshaking during an earthquake would trigger strong motion alarms controlled by the sensors operated by BART. The alarms would cause all trains to be held at the nearest station until inspection of all trackway and structures were completed by BART engineering staff and subconsultants. Train operation would be delayed until all damage was assessed and necessary repairs were completed. Low intensity shaking reported by BART personnel, which would not trigger the alarms, would lead to a five minute hold on all trains. Track inspection would be performed by operating trains at reduced speed. The inspection of trackway and structures could reduce the impacts of groundshaking effects to a less than significant level.

**Expansive Soils.** The surface soils along the entire proposed alignment have been identified as having a moderate to high shrink-swell potential. The impact of high shrink-swell potential on each of the proposed options for the alignment is the development of high soil pressures when these soils are wetted and consequently swell. The high soil pressures can cause damage

### 3.2 Soils, Geology, and Seismicity

to structures such as foundations, pavements, and retaining walls. Without appropriate mitigation, these effects would be significant impacts to the Proposed Project.

**Mitigation of Impact of Expansive Soils.** There are several options available for mitigation of the effects of expansive soils. The structures which may be affected can be designed to withstand the increased earth pressures caused by the expansive clays. Alternatively, the expansive clays can be treated with lime injection to reduce the shrink-swell potential in localized areas. The removal of expansive soils and replacement with a non-expansive fill material is another mitigative option. Expansive soil would not be used as fill behind retaining structures or beneath building foundations. Appropriate design and site preparation would mitigate the impacts of expansive soils to an insignificant level.

**Compressible Soils.** Poorly consolidated, organic sediments have a relatively high potential to compress when surface loads are applied. Organic topsoil, where not previously removed along the proposed alignment, is considered a relatively compressible material. The marsh deposits in the area of Tule Pond and Lake Elizabeth contain potentially compressible sediment layers. Construction of the proposed fill (all options) over Walnut Avenue and South Tule Pond could result in settlement of the structure as the result of compression of organic-rich sediments. Potential damage to structures caused by settlement of compressible sediments is a significant impact.

**Mitigation of the Impact of Compressible Soils.** Prudent earthwork construction practice requires that all vegetation and organic topsoil is removed prior to placement of fills or structure. Organic clay and silt deposits underlying the location of the proposed embankment at Walnut Avenue would be removed and replaced with inorganic compacted engineered fill. The organic-rich sediments would not be used as fill beneath engineered structures. The construction of the embankment would be performed in accordance with the requirements of the BART Extension Program Design Criteria, the UBC, 1988 (as amended) and the Alameda County Grading Ordinance. Following construction of the embankment, settlement would be monitored by BART surveying staff to evaluate if the track alignment has been affected. These mitigations would reduce the potential impact of settlement, such as damage to the trackway, to an insignificant level.

### **Cumulative Impacts**

**Exposure to Seismic Hazards.** Implementation of the Proposed Project may result in the development of increased population densities in proximity to rapid transit service. Increased population in the corridor would result in increased exposure of people and structures to the seismic hazards associated with the HFZ.

**Mitigation of Exposure to Seismic Hazards.** The potential exposure of people and structures to fault rupture hazards along the HFZ is mitigated to a less than significant level by the requirements of the Alquist-Priolo Special Studies Zones Act. The provisions of the Act require that permits for all development within the special studies zone established by the California Division of Mines and Geology not be granted until an investigation of fault rupture hazards is conducted. The impact of strong seismic shaking expected within the areas on buildings and other structures would be partially mitigated by the design criteria of the UBC. These mitigations can reduce but not eliminate risks from ground shaking due to a major earthquake and is an unavoidable significant impact.

### **Construction Impacts**

**Slope Instability.** Moderately deep (up to 25 feet below existing ground surface) excavation would be required for construction of cut-and-cover subway (Design Options 1 and 2S) and subgrade sections of the Proposed Project alignment near Washington Boulevard. The groundwater table is expected to be encountered at shallow depths in young sediments in the northern portion of the alignment east of the HFZ. Loose, saturated sediments may be exposed in Central Park around Lake Elizabeth. These unstable conditions, and potentially unstable conditions in more competent materials, may result in failure of excavation sidewalls which could threaten the safety of construction workers. The large fill embankment over the southern portion of Tule Pond could also fail, if not properly constructed.

**Mitigation of Slope Instability.** All excavation and fills would be designed in accordance with UBC requirements and the design criteria of the BART extension program. A dewatering program would be necessary to control groundwater seepage (and associated pore water pressure) into any excavation below the groundwater table. All trenching would be required to meet the shoring requirements of the California Occupational Safety and Health Administration (CAL/OSHA). Potential discharge of water (generated during dewatering) pumped into surface waters of the state would be regulated by the Regional Water Quality Control Board under the National Pollutant Discharge Elimination System (NPDES) requirements. Alternatively, the

### 3.2 Soils, Geology, and Seismicity

water could be discharged into the sanitary sewer system if the wastewater discharge requirements of the Union Sanitation District are met.

Permanent slopes and retaining structures for a cut-and-fill subway construction would conform with the BART seismic design criteria established for the seismic effects of the maximum credible earthquake on the HFZ. All excavation and slope construction would be performed under inspection by a qualified engineering professional, as required under the UBC. Conformance to these guidelines would reduce the impacts of slope instability below a significant level.

**Erosion.** The construction of cut slopes associated with the excavation of the subway Design Options and permanent open subgrade sections of the alignment would create steep localized slopes in the existing gentle topography of the proposed alignment. These steepened slopes would increase the erosion potential of the soils, which is low under existing conditions. The impact would be significant on newly excavated slopes during heavy rainfall.

**Mitigation of Erosion Hazard.** Erosion control on cut and fill slopes would be provided in accordance with the Alameda County Grading Ordinance (Ordinance #82-17). The slopes would be benched if slope height exceeds 30 feet and vegetated as soon after construction as possible. Concentrated surface flow would be diverted away from the slopes or conveyed by appropriate drains. The slopes would be inspected monthly after periods of heavy rainfall by BART personnel. Observed gulying would be repaired and bare slopes revegetated as soon as possible. These mitigations would reduce the impacts of erosion hazard below a level a significance.

#### 3.2.3 IMPACTS OF ALTERNATIVE 1: No Project and No Transportation Improvements (Status Quo)

This alternative would result in no change in existing conditions. The direct impacts related to geology, seismicity and soils associated with implementation of the Proposed BART Warm Springs Extension Project would not occur. The existing railways and other structures within the corridor would be subject to potential severe groundshaking, fault rupture, and fault creep. Potential significant damage to these facilities, as well as possible human injury, could occur during a large magnitude earthquake on the HFZ.



## 3.2 Soils, Geology, and Seismicity

### 3.2.4 IMPACTS OF ALTERNATIVE 2: No Project, Programmed Transportation Improvements

This alternative would not include construction of a BART Warm Springs extension. Potential impacts associated with geologic and seismic hazards identified for the Proposed Project would not occur. A number of existing and programmed highway and transit improvements would be implemented within the San Francisco Bay Area (see Section 2, Project Description). None of these projects would be directly affected by the site-specific geologic and seismic hazards identified for the Proposed Project. It is assumed that rapid development within southern Alameda County and within the railway corridor of the Warm Springs BART Extension would continue. Development in proximity to the HFZ and potentially within the Alquist-Priolo Special Studies Zone for the HFZ could cause increased exposure of structures to damage and increased risk of human injury during a large earthquake on the HFZ or the San Andreas Fault Zone. The developments may be impacted by adverse soil conditions (expansive and compressible soils; liquefaction and ground failure) identified within the railway corridor area.

### 3.2.5 IMPACTS OF ALTERNATIVE 3: Transportation Systems Management (TSM)

This alternative would not include construction of a BART Warm Springs extension. A TSM plan would be implemented, including High Occupancy Vehicle (HOV) lanes on I-880 and I-680. These projects would be implemented within the region affected by strong seismic shaking during a large earthquake on the Hayward or San Andreas Fault zones. Fault rupture on the HFZ is expected to result in damage to and closure of I-680 near Washington Boulevard in Fremont. Substantial damage and closure of I-880 from Oakland to Milpitas is expected due to settlement in areas underlain by earth materials susceptible to seismically induced ground failure.<sup>1</sup>

---

<sup>1</sup> Steinbrugge and others, 1987, op. cit.

### **3.2.6 IMPACTS OF ALTERNATIVE 4: A 5.4-Mile BART Extension with Two Stations, and Relocated Railroad**

#### **Direct Impacts**

The direct impacts of Alternative 4 are similar to the impacts identified for the same area covered by the Proposed Project. The significant impacts related to geology and seismicity include fault rupture and creep at the Walnut Avenue and Washington Avenue crossings of the HFZ, potential fault rupture at the Irvington Station, adverse soil conditions, and the effect of seismic shaking on building and other structures. Mitigation measures for these hazards are presented in section 3.2.2 of this report.

A significant difference between the Alternative 4 and the Proposed Project designs is that Alternative 4 proposes an at-grade approach to the Grimmer Road underpass. The alignment would approach the elevated Warm Springs Station on a fill embankment rather than an aerial span in the Proposed Project design. Potentially liquefiable sediments have been identified in the area of the Grimmer Road crossing. A properly designed and constructed fill and retaining structures would mitigate the significant impacts of post-construction settlement or settlement caused by seismically-induced ground failure to an insignificant level.

#### **Cumulative Impacts**

The cumulative impacts associated with Alternative 4 would be essentially the same as those for the Proposed Project. Because of the shorter length of Alternative 4 alignment, fewer riders would be expected. Potentially less development would occur at the south end of the proposed alignment. These two factors would reduce the number of persons exposed to the seismic hazards related to the project.

#### **Construction Impacts**

The construction impacts associated with Alternative 4 are similar to those described for the same area covered by the Proposed Project. These impacts include potential slope instability during excavation, erosion of steepened cuts, and fill embankment over the southern portion of Tule Pond. The construction of the fill structure at the Grimmer Road crossing in Alternative 4 would include measures to control erosion of the earthen embankment.

### **3.2.7 IMPACTS OF ALTERNATIVE 5: A 5.4-Mile BART Extension with Two Stations**

#### **Direct Impacts**

The design elements of this alternative are identical to the Proposed Project for the proposed alignment from the Fremont BART Station to and including the proposed Warm Springs Station. The direct impacts of this alternative would be similar to those described for the Proposed Project and Alternative 4.

#### **Cumulative Impacts**

The cumulative impacts of Alternative 5 would be the same as those described for Alternative 4. The shorter length of the alternative may result in less development within the southern portion (south of the Warm Springs Station) and, therefore, potentially expose fewer persons to the seismic shaking hazards identified for the Proposed Project.

#### **Construction Impacts**

The construction impacts of Alternative 5 would be identical to those associated with Alternative 4 with the exception of potential erosion and sedimentation associated with construction of the fill structure at Grimmer Road, which is replaced by an aerial structure in Alternative 5.

### **3.2.8 IMPACTS OF ALTERNATIVE 6: A 7.8-Mile BART Extension with Two Stations (no Irvington Station)**

#### **Direct Impacts**

The direct impacts of Alternative 6 would include potential track displacements, fault rupture, or fault creep at the alignment crossing at the HFZ at Walnut Avenue and potential structural failure during expected strong ground shaking during the MCE. Potential impacts identified for the Proposed Project associated with expandable and compressible soils would also require similar mitigation under this alternative.

Alternative 6 would not include an Irvington Station and some of the impacts identified for the Proposed Project would not apply to this alternative. Specifically, the potential for structural

## 3.2 Soils, Geology, and Seismicity

damage or human injury related to the placement of a station within an Alquist-Priolo Special Studies Zone would be avoided. The aerial crossing option of Washington Boulevard would reduce the potential for cut slope failure during strong seismic shaking, which was identified as a potential impact for the Proposed Project.

The aerial option for Alternative 6 would result in an aerial crossing of the HFZ. Potential failure of the aerial structure and train derailment caused by fault rupture could result in a greater risk of human injury than an at-grade or sub-grade crossing of the fault zone, proposed by other options for this alternative and the Proposed Project. If properly designed, the aerial span may reduce the impact of fault creep at the Washington Boulevard HFZ crossing. The displacement caused by creep would be distributed over a longer distance between rigid structures compared to a subgrade crossing, which would reduce the potential for the development of localized strain.

### **Cumulative Impacts**

Operation of the Alternative 6 alignment, which does not include the construction of Irvington station, would reduce the exposure of persons to the potential hazards of fault rupture near the fault traces of the HFZ. Implementation of the Washington Boulevard Design Option in Alternative 6 would, however, potentially increase the number of persons exposed to the potential effects of strong groundshaking.

### **Construction Impacts**

The construction impacts and mitigations related to Alternative 6 would be similar to those described for the Proposed Project. The application of the Washington Boulevard Design Option (an above-grade crossing on an embankment) instead of the proposed subway or open subgrade construction would reduce the potential for erosion and slope or tunnel instability.

### **3.2.9 IMPACTS OF ALTERNATIVE 7: A 7.8-Mile BART Extension with Two Stations (no Irvington Station)**

#### **Direct Impacts**

The direct impacts of Alternative 7 would be similar to the Proposed Project, except that having no Irvington station would reduce the impact of potential exposure of people and structures to

## 3.2 Soils, Geology, and Seismicity

fault rupture hazards. Potential direct impacts along the southern portion of Alternative 7 includes possible localized ground failure (including liquefaction), as in the Proposed Project. The aerial crossing of Washington Boulevard would be similar to the aerial option for Alternative 6 and could result in the increased risk of structural damage or collapse during strong groundshaking caused by large earthquakes.

### **Cumulative Impacts**

The cumulative impacts associated with Alternative 7 are similar to those described for the Proposed Project and would require similar mitigation.

### **Construction Impacts**

Implementation of Alternative 7 would not present unique construction phase impacts compared to those identified for the Proposed Project. Potential construction impacts associated with excavations (slope stability and erosion) of the subway and subgrade options of the Proposed Project would not be encountered during construction of Alternative 7.

### **3.2.10 IMPACTS OF ALTERNATIVE 8: A 7.8-Mile BART Extension along Osgood Road and Warm Springs Boulevard, with Two Stations (no Irvington Station)**

#### **Direct Impacts**

North of Washington Boulevard the alignment of Alternative 8 would be similar to Alternative 7. Both alternatives include an aerial crossing of the Hayward Fault and Washington Boulevard. Neither alternative would include an Irvington Station or the associated excavations included in the Proposed Project.

South of Washington Boulevard, Alternative 8 would include an aerial span to be located in the center of Osgood Road and Warm Springs Boulevard. Elevated Warm Springs and South Warm Springs stations would be constructed as part of this alternative. The elevated section of this alternative would be constructed on the young sediments of the Niles Cone and older sediments of Warm Springs Alluvial Apron. Foundation conditions for aerial supports would be variable and may include potentially liquefiable sediments, particularly in the younger sediments. The supports would be placed on foundations supported by piles penetrating dense alluvium below the depths of potentially liquefiable sediments.

The aerial spans and supports would be designed, in accordance with the BART Extension Program Design Criteria, to withstand seismic shaking expected during the maximum credible earthquake on the HFZ. Although the potential for structural failure would be reduced by appropriate design and construction, failure of an aerial span would increase the risk of catastrophic derailment relative to at-grade designs. Collapse of an aerial support or span section could result in injury or damage to people or property located below.

### **Cumulative Impacts**

Alternative 8 does not present unique cumulative impacts with respect to geologic or seismic conditions. The impact of exposing more people to seismic hazards along the HFZ is similar to the impact described for the Proposed Project.

### **Construction Impacts**

The construction of Alternative 8 would not require the construction of cutslopes in the vicinity of the proposed Irvington station (the Proposed Project or alternatives 4 and 5) and would not create the associated potential slope instability and erosion impacts.

#### **3.2.11 IMPACTS OF ALTERNATIVE 9: A 5.4-Mile BART Extension with One Station (Warm Springs)**

The Alternative 9 alignment would be a 5.4-mile extension to the Warm Springs station, and would not include an Irvington station. From the Fremont Station to the proposed Warm Springs station, Alternative 9 would have much the same impacts and mitigations as Alternative 6. Cumulative impacts would be similar to those described for Alternative 4.

#### **3.2.12 IMPACTS OF ALTERNATIVE 10: A 7.8-Mile BART Extension with One Station (South Warm Springs)**

The impacts related to geologic and seismic conditions of Alternative 10 are similar to those described for Alternative 6. Exclusion of the Warm Springs station may reduce the number of persons exposed to seismic hazards relative to Alternative 6. In comparison to the Proposed Project, the impacts associated with construction of a subgrade Irvington station within the

## 3.2 Soils, Geology, and Seismicity

Alquist-Priolo Special Studies Zone for the HFZ would be avoided. The cumulative impacts for Alternative 10 would be similar to those described for the Proposed Project.

### **3.2.13 IMPACTS OF ALTERNATIVE 11: A 7.8-Mile BART Extension with Two Stations (No Warm Springs Station)**

The Alternative 11 alignment would be identical to the Proposed Project, but would be without the Warm Springs station. The alternative would have much the same direct, cumulative and construction impacts as the Proposed Project, but the elimination of the Warm Springs station would incrementally reduce the number of exposure of people to seismic hazards.

## 3.3 HAZARDOUS MATERIALS

### 3.3.1 SETTING

#### Introduction

The presence of hazardous materials, above ground or in the subsurface soils or groundwater along and adjacent to the Proposed Project alignment, could impact public health and safety or the environment during construction or operation of the Proposed Project. Excavation of soils containing hazardous materials would require specific management, resulting possibly in either on-site treatment and/or off-site disposal.

To evaluate the potential and known contamination along the project corridor, information regarding past and present land uses involving the use and storage of hazardous materials was obtained, and regulatory agency files were reviewed. A Draft EIR for an alignment previously proposed by BART was prepared in May 1990.<sup>1</sup> An environmental liability assessment was prepared in August 1990 for the Proposed Project alignment under review in this Draft EIR.<sup>2</sup> In addition, soil samples were collected along the project site, and the results of sample analyses were presented in a report prepared for BART in April 1991.<sup>3</sup>

*A hazardous material is defined as "...any material that, because of its quantity, concentration, or physical or chemical characteristics, poses a significant present or potential hazard to human health and safety, or the environment. Hazardous materials include, but are not limited to, hazardous substances, hazardous waste, and any materials which a handler or the administering agency has a reasonable basis for believing that it would be injurious to the health and safety of persons or harmful to the environment if released into the workplace or the environment."*

*-- California Health and Safety Code, Section 25501.*

The following describes the regulatory framework pertaining to management of hazardous materials, California Transportation Commission (CTC) policies regarding acquisitions of rail right-of-way property, and provides a discussion of the potential and known contamination along

---

<sup>1</sup> Bay Area Rapid Transit District, *Draft Environmental Impact Report, Warm Springs Extension Project*, May, 1990.

<sup>2</sup> Ausmus, Beverly S., *Needs Assessment: Environmental Liability Assessment, Warm Springs Extension Project*, August, 1990.

<sup>3</sup> Kal Krishnan Consulting Services, Inc., *Phase II Environmental Survey, Warm Springs Extension*, April, 1991.



the Proposed Project alignment and build alternatives, based on review of regulatory agency files, past and current land uses, and previously prepared reports.

#### **Regulatory Framework**

The use, storage and disposal of hazardous materials, including management of contaminated soils and groundwater, are regulated by local, state, and federal laws. The agencies responsible for enforcing applicable regulations develop and enforce standards for the handling, cleanup, and disposal of specific materials determined to pose a health risk. The enforcing agencies at the local level for the project site include: the City of Fremont Hazardous Materials Division; the Alameda County Health Services Agency, Hazardous Materials Division; and the Alameda County Water District. Enforcement agencies at the state level include the San Francisco Bay Regional Water Quality Control Board, and the Department of Health Services, Toxic Substances Control Division. The federal enforcement agency is the US Environmental Protection Agency. A description of agency involvement in management of hazardous materials is provided below.

**US Environmental Protection Agency.** The US Environmental Protection Agency (EPA) is the federal agency responsible for enforcement and implementation of federal laws and regulations pertaining to hazardous materials. The federal regulations are primarily codified in Title 40 of the Federal Code of Regulations (40 CFR). The legislation is set forth in the Resource Conservation and Recovery Act of 1976 (RCRA), the Superfund Amendments and Reauthorization Act (SARA), and in the Comprehensive Environmental Response, Compensation, and Liability Act of 1980 (CERCLA). The laws and regulations include specific requirements for facilities that generate, use, store, treat, and/or dispose of hazardous materials. The EPA provides oversight and supervision for some site investigation/remediation projects. For disposal of certain hazardous materials, the EPA has developed land disposal restrictions and treatment standards.

**Department of Health Services, Toxic Substances Control Division.** In California, the Toxic Substances Control Division of the Department of Health Services (DHS) works in conjunction with the EPA for the enforcement and implementation of hazardous materials laws and regulations. California has enacted legislation pertaining to the management of hazardous materials, which incorporates most federal laws and regulations. The state hazardous materials regulations are codified in Title 26 of the California Code of Regulations (CCR). The California legislation primarily includes the Hazardous Waste Control Act and the Hazardous Substance Account Act. The DHS acts as the lead agency for some soil and groundwater

### 3.3 Hazardous Materials

cleanup projects and, for other cases, delegates lead agency authority to the Regional Water Quality Control Board or a local agency. The DHS sets cleanup and action levels for subsurface contamination; these levels are equal to or are more restrictive than federal levels. For disposal of hazardous materials in California, not regulated at the federal level, the DHS has developed land disposal restrictions and treatment standards.

**Regional Water Quality Control Board, San Francisco Bay Region.** The Proposed Project alignment is located within the jurisdiction of the San Francisco Bay Regional Water Quality Control Board (RWQCB). The RWQCB is authorized by the Porter-Cologne Water Quality Act of 1969 to implement water quality protection laws, including some federal water protection laws specified in CCR Title 26, Division 23, Subchapter 16. When the quality of the groundwater or the surface waters of the state are threatened, the RWQCB has the authority to require investigations and remedial actions, when necessary. The RWQCB provides oversight in cases which require permits, investigation, and/or remediation. Extraction of contaminated groundwater or dewatering during construction, and subsequent discharge of such waters to the storm drain or to the waters of the state or to the sanitary sewer system would require permits from the RWQCB or the local publicly-owned treatment works, respectively.

**Alameda County Water District.** At sites within the City of Fremont where groundwater quality is threatened, the Alameda County Water District (ACWD) works with the RWQCB to oversee and provide guidelines for the investigation and cleanup of contaminated sites. The ACWD acts in a technical advisory capacity to the RWQCB; the district is not an enforcement agency.

**Alameda County Health Services Agency, Hazardous Materials Division.** The Hazardous Materials Division of the Alameda County Health Services Agency (County) conducts inspections to ensure proper handling and storage of hazardous materials in Alameda County and is the local enforcement agency for those portions of Alameda County that do not have an environmental health program implemented by a city. For the City of Fremont, the County shares responsibility for enforcing the proper storage and disposal of hazardous materials with the City.

**City of Fremont Hazardous Materials Department.** For facilities located within City of Fremont boundaries, the City of Fremont Hazardous Materials Department (City) is the enforcing agency for the handling and storage of hazardous materials. The City issues business plans, which are required by State law, submitted by facilities that use or store hazardous materials above a certain quantity. The City also maintains operating permits for underground storage tanks. For sites where soil or groundwater contamination has been identified, or where

### 3.3 Hazardous Materials

releases of hazardous materials have been reported, the City will work in conjunction with DHS or the RWQCB to provide guidelines and oversight in site cleanup and environmental compliance.

#### **California Transportation Commission (CTC) Policies**

The CTC has developed policies, outlined in Resolution G-91-2, which require hazardous materials investigation and clean-up activities prior to acquisition of or funding for rail right-of-way properties. A copy of the resolution is shown in Appendix B. The purpose of the CTC's policies is to assign responsibility for the investigation and remediation of contaminated sites to protect property values, minimize liability, and ensure that allocated funds are not used for activities associated with the clean-up of hazardous materials.

#### **Potential for Contamination Along the Proposed Project Alignment**

The current or past use and storage of hazardous materials, at or near the Proposed Project alignment could have resulted in contamination of subsurface soils or groundwater. Potential sources of contamination include facilities along and adjacent to the Proposed Project alignment where hazardous materials are or were used and stored, and where a release of hazardous materials is suspected or known to have occurred.

Current and past land uses on and near the Proposed Project alignment were researched to identify locations where hazardous materials may be, or may have been present. As part of the studies previously prepared for the project, regulatory agency files were reviewed to identify sites listed by agencies as having potential or known subsurface contamination. In March 1991, as part of this Draft EIR, an agency record search was conducted to update the list of sites identified in the previous studies. All sites identified in the record searches are described in Table 3.3-1. The locations of the sites are shown in Figure 3.3-1. A discussion of agency record search activities, the current and past land uses at the Proposed Project alignment possibly associated with hazardous materials, and brief summaries of the previous studies are provided below.

**Agency Record Search Activities.** Regulatory agencies maintain records for sites where the presence of hazardous materials has been reported and where site investigation/remediation activities are in progress or required. Regulatory agency files consulted included the National Priorities List (NPL), the Comprehensive Environmental Response, Compensation, and Liability Information System (CERCLIS) maintained by the EPA; the Abandoned Sites Profile

**Table 3.3-1  
Potential and Identified Hazardous Materials Sites Along Or  
Adjacent to Proposed Project Alignment  
BART Warm Springs Extension EIR**

Site Name and Address	Incident	Potential or Known Subsurface Contaminants	Status
1. Unknown Paseo Padre & SPRR <sup>1</sup>	Fremont Fire Dept. responded to a fuel spill (<50 gal.) in 2/85.	Petroleum hydrocarbons potentially present.	No further information.
2. Tri City Rock <sup>2</sup> 3553 Washington Blvd.	An underground diesel tank was removed from the site in 1987.	Petroleum hydrocarbons potentially present.	Unknown.
3. Mission Valley Equipment Rental <sup>2</sup> 41655 Osgood Road	Release from underground diesel and gasoline tanks reported in 7/87 and 1/90.	Petroleum hydrocarbons identified in soils and groundwater.	RWQCB and local agencies have requested site investigation and remediation activities.
4. Fremont Lumber Co. <sup>1</sup> 3560 Washington Blvd.	Release from underground gasoline tank which was removed in 1988.	Petroleum hydrocarbons identified in soils	A work plan to conduct site investigation was prepared by owner in 8/90. No further information available on file.
5. Howard's Backhoe Service <sup>1</sup> 41875 Osgood Road	Release from underground gasoline, diesel, and waste oil tanks.	Petroleum hydrocarbons identified in soils and groundwater	In 2/91, ACWD requested that the property owner conduct site investigation activities.

Table 3.3-1 - continued

Site Name and Address	Incident	Potential or Known Subsurface Contaminants	Status
6. Fee Construction <sup>1</sup> 42000 Osgood Road	Removal of underground gasoline and diesel tanks.	Petroleum hydrocarbons identified in vapor monitoring well in 3/87. Laboratory results of soil samples collected in 6/87 showed no compounds.	No further information available in file.
7. Nume Oh-Howe <sup>1</sup> 42021 Osgood Road	Notices of violation issued by County based on inspection of site by County.	Unknown.	County has requested Plan of Correction to be prepared by owner. No further information available in file.
8. Bay Area Concretes, Inc. <sup>1</sup> 43055 Osgood Road	Removal of two underground gasoline tanks in 6/88.	Petroleum hydrocarbons identified in soils and groundwater in 3/88. Petroleum hydrocarbons identified only in groundwater in 6/88.	In 12/90, ACWD requested that the property owner conduct further site investigation activities.
9. Grade-Way Construction <sup>1</sup> 43801 Osgood Road	Release from underground gasoline and diesel tanks.	Petroleum hydrocarbons identified in soils and groundwater in 6/85. Groundwater samples collected in 3/90 did not contain petroleum hydrocarbons above detection limits.	Site investigation by owner in progress.
10. Jonce Thomas Construction <sup>1</sup> 3390 Seldon Court	Release from underground gasoline tank.	Petroleum hydrocarbons identified in soils and groundwater.	In 8/88, ACWD requested that the property owner conduct further site investigation activities.
11. Bay Con Company <sup>1</sup> 2150 Prune Avenue	Release from underground diesel tank in 7/90.	Petroleum hydrocarbons identified in soils.	No further information available in file.
12. Inland Steel <sup>3</sup> 2875 Prune Avenue	Two underground gasoline tanks removed in 1/89.	Soil samples did not contain level of petroleum hydrocarbons above detection.	Unknown.

Table 3.3-1 - continued

Site Name and Address	Incident	Potential or Known Subsurface Contaminants	Status
13. Fremont Wire & Plating <sup>3</sup> 2156 Prune Avenue	Improper storage of sodium hydroxide and sulfuric acid; sodium hydroxide spill.	Metals identified in soils.	City has granted closure of site.
14. Mallar Finishing <sup>3</sup> 2878 Prune Avenue	City issued violation due to improper storage.	Unknown.	Unknown.
15. Glenmoor Companies <sup>2</sup> 2020 Warm Springs Court	Storage of waste oil in 55-gal. drum; violation issued 1/90.	Unknown.	Unknown.
16. Tri-City Circuits <sup>3</sup> 2199 Warm Springs Court	Transportation, storage, and disposal facility; violations due to improper handling of hazardous materials.	Unknown.	Unknown.
17. J&L Enterprises <sup>2</sup> 2040 Warm Springs Court	Violations issued in 9/88 due to improper labeling, storage, and disposal of hazardous materials.	Unknown.	Unknown.
18. Russett Diesel Service <sup>3</sup> 2090 Warm Springs Court	Removal of underground gasoline and diesel tanks.	Petroleum hydrocarbons, including oil and grease, detected in soils.	Unknown.
19. The Pump Shop <sup>1</sup> 45845 Warm Springs Blvd.	Notices of violation issued in 5/89 and 10/89 by County due to contaminated absorbent material located in storm drain sump.	Unknown.	No further information available in file.
20. Mobil <sup>3</sup> 46840 Warm Springs Blvd.	Release from underground waste oil tank.	Petroleum hydrocarbons, including oil and grease, identified in soils and groundwater.	Quarterly monitoring in progress.

Table 3.3-1 - continued

Site Name and Address	Incident	Potential or Known Subsurface Contaminants	Status
21. General Motors <sup>3</sup> Fremont Blvd.	Removal of underground tanks in 4/85.	Petroleum hydrocarbons identified in soils and groundwater.	Unknown.
22. Tulloch Construction Co. <sup>1</sup> 48233 Warm Springs Blvd.	Removal of underground diesel tank.	Petroleum hydrocarbons identified in groundwater.	Groundwater monitoring in progress.
23. Apple Computer <sup>1</sup> 48233 Warm Springs Blvd.	Removal of wastewater tank in 1982.	Chlorinated solvents identified in groundwater.	Remediation report prepared in 6/89. No further information available in file.
24. Troy Products of California <sup>3</sup> 48330 Milmont Drive	Illegal disposal of waste oil on-site.	Petroleum hydrocarbons identified in soils.	Unknown.
25. Sequoia Institute <sup>1</sup> 420 Whitney Place	Removal of underground waste oil tanks.	Petroleum hydrocarbons identified in soils and groundwater.	In 9/89, ACWD requested that the property owner conduct site investigation.
26. Emkay Development Co. <sup>3</sup> 48531 Warm Springs Blvd.	Removal of underground gasoline and diesel tanks.	Petroleum hydrocarbons and metals detected in soils.	ACWD approved site closure.
27. Fleming Foods <sup>3</sup> 48811 Warm Springs Blvd.	Unknown.	Petroleum hydrocarbons identified in groundwater.	Groundwater monitoring in progress.

Table 3.3-1 - *continued*

Site Name and Address	Incident	Potential or Known Subsurface Contaminants	Status
28. Bedford Properties/Cal Concrete <sup>1</sup> 48870 Kato Road	Removal of underground gasoline and diesel tanks.	Petroleum hydrocarbons identified in soils and groundwater.	A bioremediation closure report was prepared for site in 12/89.
29. Tempglass <sup>1</sup> 48999 Kato Road	Site has been identified on RWQCB Underground Fuel Leaks List.	Unknown. No information in file.	Unknown. No information in file.
30. Hertz Equipment Rental <sup>1</sup> 48887 Kato Road	Release from underground waste oil tank in 3/89.	Oil and grease identified in soils.	No further information available in file.
31. Emco Dist. <sup>1</sup> 48900 Milmont Drive	Groundwater monitoring program implemented in 12/85.	Petroleum hydrocarbons identified in groundwater.	No further information available in file.

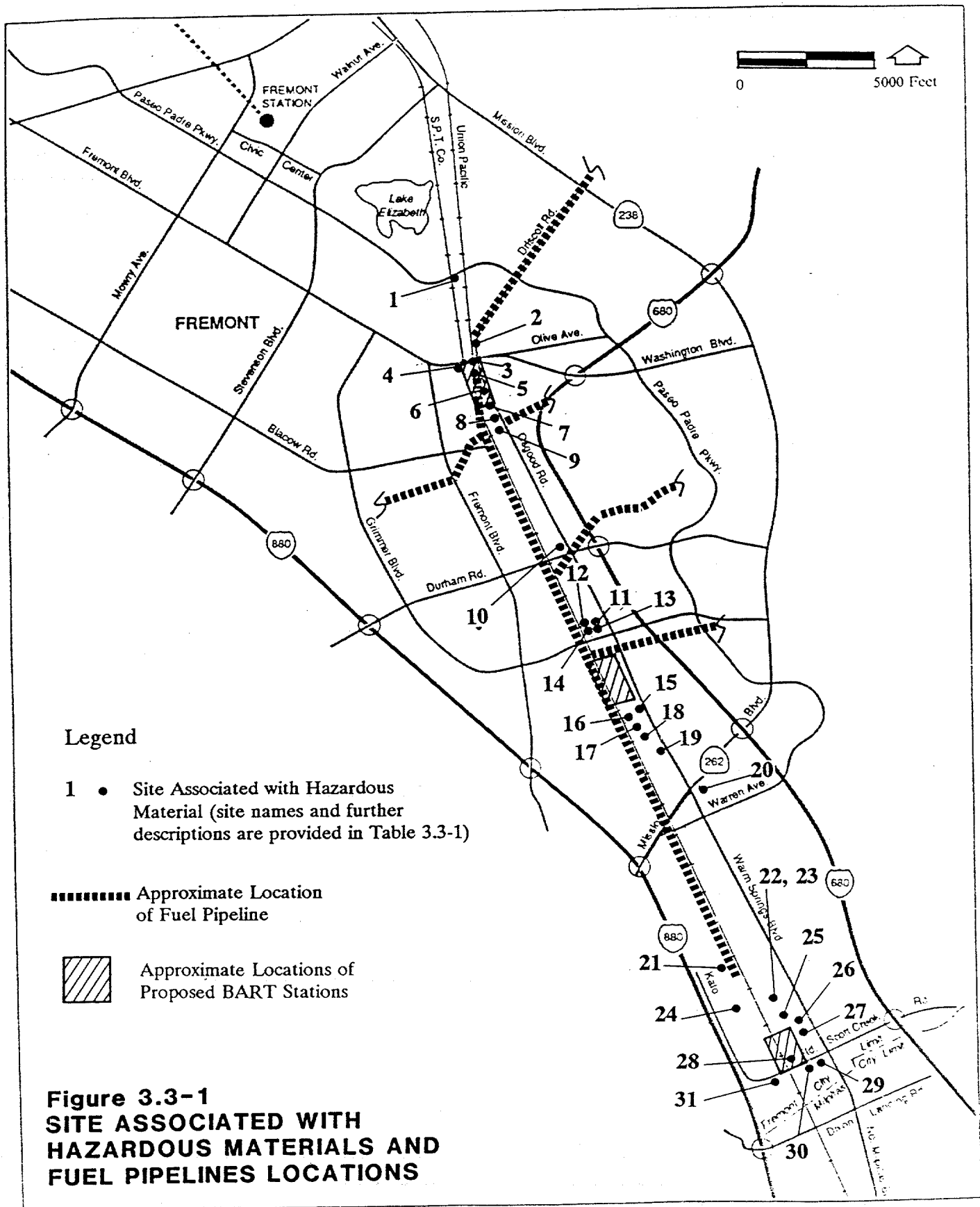
<sup>1</sup> Source: RWQCB files, reviewed by Baseline in April 1991.

<sup>2</sup> Sources: BART, 1990, Draft EIR for Warm Springs Extension Project.  
Ausmus, Beverly, 1990, Needs Assessment: Environmental Liability Assessment, Warm Springs Extension Project.

<sup>3</sup> Source: Kal Krishnan Consulting Service, 1991, Phase II Environmental Survey, Warm Springs Extension.

Notes:  
RWQCB = Regional Water Quality Control Board.  
City = City of Fremont.  
ACWD = Alameda County Water District  
Locations of sites are shown on Figure 3.3-1.





SOURCE: Baseline Environmental Consulting, 1991

Information System (ASPIS), the State Bond Expenditure Plan, and the list of California Resource Conservation and Recovery Act (RCRA) facilities maintained by DHS; the Hazardous Waste and Substances Sites List, prepared by the State Office of Planning and Research; the Underground Fuel Leaks List and the North Bay Toxics Cases maintained by the RWQCB; and files maintained by the ACWD and the City of Fremont.

Based on review of regulatory agency files, 31 sites associated with the use or storage of hazardous materials were identified on and near the Proposed Project alignment (Table 3.3-1 and Figure 3.3-1). Contaminants identified as being present or potentially present in the subsurface of the project corridor include petroleum hydrocarbons and associated organic compounds,<sup>1</sup> aromatic compounds, chlorinated solvents, and metals. These contaminants are primarily associated with the past or current operation of leaking underground storage tanks which contain gasoline, diesel, waste oil, or other fuel products, but also may be associated with the use of hazardous materials stored in above ground containers.

**Current Land Uses.** Current land uses along and adjacent to the proposed alignment that may involve the use or storage of hazardous materials include the Southern Pacific Transportation Company (SPTCo) railroad right-of-way, the Union Pacific railroad (UPRR) right-of-way, and agricultural and industrial uses in the area. (For locations of these land uses in the corridor, see Figure 3.6-1 in the land use section.) The types of hazardous materials potentially associated with these uses include waste oils, petroleum hydrocarbons, solvents, pesticides or herbicides, and creosote and pentachlorophenol applied as wood preservative to railroad ties. In addition, underground fuel pipelines located along portions of the Proposed Project alignment may be sources of fuel leakage (Figure 3.3-1).

**Past Land Uses.** Information about past land uses at the project was obtained by reviewing historical aerial photographs for the years 1954, 1966, 1977, and 1988.<sup>2</sup> Historical land uses shown in the photographs were predominantly agricultural in 1954, with increasing industrial and residential uses from 1954 to 1988. The SPTCo and UPRR rights-of-way were shown on the photographs for 1954 through 1988. Potential hazardous materials associated with these uses include pesticides or herbicides, waste oils, petroleum hydrocarbons, solvents, and creosote and pentachlorophenol which may be contained in railroad ties.

---

<sup>1</sup> For the purposes of this section, petroleum hydrocarbons and associated organic compounds include: gasoline, diesel, or oil and grease, and/or benzene, toluene, total xylenes, or ethylbenzene.

<sup>2</sup> Pacific Aerial Surveys, 1991, Aerial photographs dated 1954, 1966, 1977, and 1988.

**May 1990 Draft EIR.** The Hazardous Materials section of the Warm Springs Extension Draft EIR prepared in May 1990 included a description of several sites associated with hazardous materials in the project vicinity. These sites are included in Table 3.3-1 of this section.

**August 1990 Needs Assessment: Environmental Liability Assessment.** This report, prepared for the proposed Warm Springs Extension Project, describes the results of review of regulatory agency files and provides a work plan for the collection of soil and groundwater samples along the project corridor, based on information obtained from agency file review and analysis of historical land uses. The report recommended that site specific investigations be conducted along the alignment near the sites considered to be "...representative of the worst case conditions along the alignment."<sup>1</sup> Recommendations for site investigation activities included collection and analyses of soil and groundwater samples.

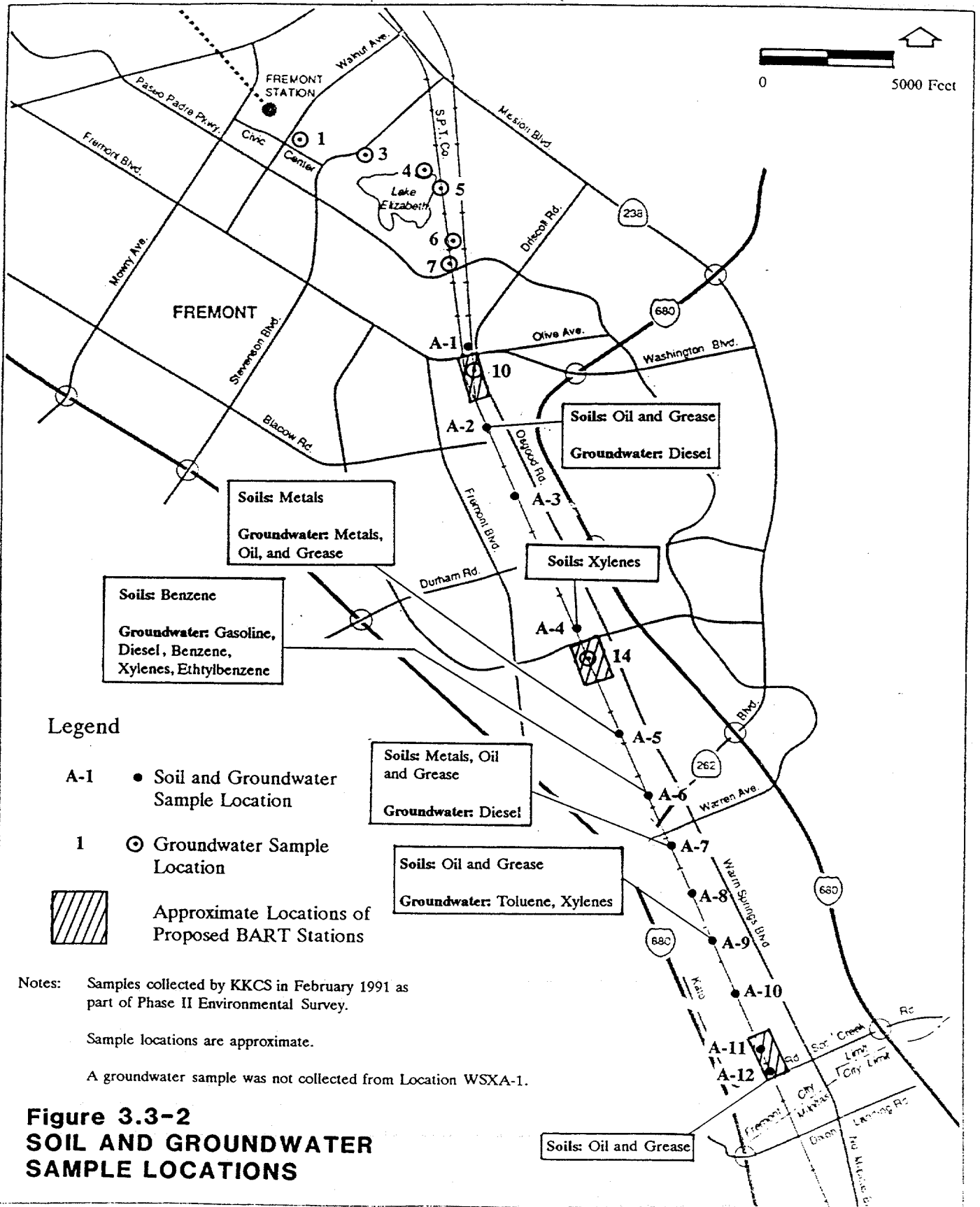
**April 1991 Phase II Environmental Survey.** A subsurface investigation was conducted to identify the presence of hazardous materials in the soils and groundwater within the project corridor. Soil and groundwater samples were collected at 20 locations along the Proposed Project alignment (Figure 3.3-2). To determine sample locations and appropriate chemical analyses, regulatory agency files were reviewed and site information was updated and compiled into a table which is summarized in Table 3.3-1. Based on agency record search activities and consultation with the ACWD, all samples were analyzed for petroleum hydrocarbons and associated compounds, and some samples were also analyzed for organic and inorganic compounds, including volatile organic compounds and specific heavy metals. Analytical results of soil and groundwater sampling are discussed below.

#### **Known Contamination Along the Proposed Project Corridor**

Known subsurface contaminants in the Proposed Project corridor identified during the regulatory agency record search are described above and included in Table 3.3-1. The known contaminants, identified in soils and groundwater, primarily include petroleum hydrocarbons and associated compounds, chlorinated solvents, and metals. The analytical results of soil and groundwater samples collected during the Phase II Environmental Survey in 1991 identified contaminants at several sample locations along the Proposed Project alignment. The locations where soil and/or groundwater samples were collected and where contaminants were detected above laboratory reporting limits are shown on Figure 3.3-2. A summary of soil and figure 3.3-

---

<sup>1</sup> Ausmus, Beverly, 1990, op. cit., p.1.



SOURCE: Baseline Environmental Consulting, 1991

groundwater sample results from the Phase II environmental survey is provided in a table in Appendix A. Petroleum hydrocarbons identified as oil and grease were found in soil from sampling locations A-2, A-7, A-9, and A-12. Petroleum hydrocarbons were detected in groundwater samples at locations A-2, A-5, A-6, A-7, and A-9. Aromatic hydrocarbons were identified in the soil at locations A-4 and A-6 and in groundwater at A-6 and A-9. Metals were detected in the soil and groundwater at location A-5, and in soil at A-7 (Figure 3.3-2).

#### 3.3.2 IMPACTS OF PROPOSED PROJECT AND DESIGN OPTIONS

##### **Direct Impacts**

According to CEQA Guidelines, the use, production or disposal of materials which pose a hazard to people, animal, or plant populations would be considered a significant environmental impact.<sup>1</sup> Potential impacts associated with the use and storage of hazardous materials along the Proposed Project alignment are primarily construction related. The discovery of hazardous materials in the soils or groundwater during project development and construction could pose a health and safety hazard to construction workers, the general public, or the environment.

Potential direct environmental impacts associated with the management of hazardous materials in the project area include: exposure of the public to contaminated soils or groundwater, resulting in health or safety risks; and interruption or delay of site investigation/remediation activities due to project development or operation. These potential impacts, described below, would apply to the project as proposed and to each of the design options.

##### **Impact of Exposure to Hazardous Materials**

Operation of the project would not involve the use or storage of hazardous materials; however, there is a potential exposure to hazardous materials due to underground fuel pipelines located along portions of the proposed alignment. Ruptured or leaking fuel pipelines could contaminate surrounding soils or groundwater and create a potential health and safety risk. In addition, the proposed BART alignment would be located adjacent to the existing SPTCo and UPRR tracks, which could expose BART patrons to hazardous materials spills in the event of a train accident

---

<sup>1</sup> California Office of Planning and Research, 1986, CEQA: California Environmental Quality Act, Statutes and Guidelines, Appendix G, p. 284.

or collision involving a SPTCo or UPRR train carrying hazardous materials. Trains from both rail companies carry hazardous materials on the tracks on a daily basis.<sup>1,2</sup>

#### **Mitigation of Exposure to Hazardous Materials**

BART has developed an Emergency Plan<sup>3</sup> which includes procedures for responding to a release of hazardous materials. The purpose of the response procedures is to minimize exposure and risk to public health and safety. The procedures include: immediate evacuation of persons from the vicinity of the spill; prompt notification of the incident to appropriate BART personnel and responsible agencies, such as the local fire department; termination of BART operations and shut-off of power, if necessary; and cooperation with responding agencies, such as the local fire departments. Considering the materials used as part of BART operations, this mitigation would reduce this impact below a level of significance.

Requirements for the operation and maintenance of underground fuel pipelines are specified in the Federal Hazardous Liquid Pipeline Safety Act and in California's Pipeline Safety Act, which is enforced by the State Fire Marshal. To mitigate the potential increased exposure to hazardous materials from the rupture or leaking of underground fuel pipelines or from a train accident involving hazardous materials, the hazardous materials spill response procedures outlined in the Emergency Plan for the operation of the Proposed Project will continue to be updated, maintained, and implemented by BART. The emergency plan would reduce the exposure of people to hazardous materials to an insignificant level, but would not reduce the risk of occurrence of a release.

#### **Impacts of Interruption or Delay of On-going Site Investigation/Remediation Activities**

Implementation and operation of the Proposed Project prior to completion of all site investigation/remediation activities along the proposed alignment could interfere or delay investigation and cleanup efforts. Interruption of site remediation could result in increased soil and groundwater contamination due to continued migration of contaminants through the soil and

---

<sup>1</sup> Robert Huebel, Manager of Train Operations SPTCo, personal communication, 29 May, 1991.

<sup>2</sup> Neil Hayden, Manager of Operations, UPRR, personal communication, 29, May 1991.

<sup>3</sup> Bay Area Rapid Transit District, 1981, Emergency Plan.

groundwater. This is a significant impact. Potential increased exposure of people to contaminants and increased cost of mitigation related to interception are significant impacts.

#### **Mitigation of Interruption or Delay of On-going Site Investigation/Remediation Activities**

To mitigate the effects of project implementation prior to cleanup of contaminated soils and groundwater on or near the extension alignment, BART would cooperate with investigation and cleanup efforts to the extent possible. BART would provide access as necessary onto BART property for collection of soil samples, installation and monitoring of groundwater wells, or management of contaminated soils or groundwater. Persons conducting investigation/remediation activities would be required to comply with all regulatory requirements and BART safety and emergency programs. This would reduce the impact below a level of significance.

#### **Impacts During Construction**

Potential construction-related impacts for the Proposed Project are primarily associated with the exposure of construction workers and the general public to hazardous materials present in the soils or groundwater. For the purpose of this section, the construction-related impacts are either significant, based on levels of contaminants identified, or potentially significant based on no levels of contaminants identified and/or available regulatory information. Potentially significant impacts have been identified along the entire length of the proposed alignment and design options because it is possible that unknown/unrecorded uses and/or disposal of hazardous materials have occurred. Even in those areas which have been subject to subsurface investigations and where no chemical compounds have been identified, potentially significant impacts could occur during construction. Construction-related impacts and mitigation described below would apply to the Proposed Project and all design options.

#### **Impact of Exposure to Hazardous Materials Resulting from Construction of the Proposed Project**

Construction of the Proposed Project could result in the discovery of hazardous materials in the subsurface. Various health risks to both construction workers and the general public are associated with exposure to contaminated soils and/or groundwater encountered during development activities such as grading, excavation, and/or dewatering. On-site management of contaminated excavated soils could also pose health risks to exposed persons. Possible rupture of fuel pipelines during excavation could create an additional health and safety hazard, due to explosion or exposure. These are significant impacts.

### 3.3 Hazardous Materials

Dewatering activities conducted at the project site could result in impacts to local groundwater flow direction, as well as in health risks to construction workers from exposure to contaminated groundwater, and environmental impacts to surface waters receiving the discharged water from the excavations. The impacts to local groundwater flow direction, which could potentially interfere with local on-going groundwater investigations, are discussed in detail in Section 3.4.2 (Hydrology).

Based on the data obtained from agency records and soil and groundwater sample analyses in and near the Proposed Project alignment, the underground fuel pipelines and the locations where hazardous materials have been identified in the subsurface, certain portions of the proposed alignment could result in exposure of workers during grading, excavation, or dewatering. The detection of contaminants suggests that a release of hazardous materials has occurred near the sample sites. The extent and magnitude of the contamination is not known. Specific health and safety precautions will depend on potential levels of exposure. The impacts of the fuel pipelines and subsurface hazardous materials at each portion of the alignment are discussed below.

- **Fremont Station to Proposed Irvington Station.** According to regulatory agency file review, two sites (1 and 2 on Figure 3.3-1 and Table 3.3-1) located along the proposed alignment between the existing Fremont Station and the proposed Irvington Station may contain petroleum hydrocarbons in the subsurface. No information regarding site investigation activities was available in agency records for the two sites.

Soil and groundwater samples collected and analyzed at locations between the Fremont and proposed Irvington stations did not contain chemical compounds above laboratory detection limits (Figure 3.3-2).<sup>1</sup> Impacts associated with discovery of hazardous materials at this portion of the proposed alignment are considered to be potentially significant.

---

<sup>1</sup> Kal Krishnan Consulting Services, 1991, op. cit.



- **Proposed Irvington Station.** Hazardous materials were identified in the subsurface at sites 3, 4, 5, 6, and 8 (Figure 3.3-1 and Table 3.3-1) in the vicinity of the proposed Irvington Station location, according to agency files. Additional site investigations have been required by regulatory agencies for each of the sites, except site 6 (Figure 3.3-1 and Table 3.3-1). Chemical analyses of soil and groundwater samples collected from the vicinity of the proposed station location (sample A-2) indicated the presence of petroleum hydrocarbons in the subsurface (Figure 3.3-2).<sup>1</sup> The extent of subsurface contamination identified at this location is unknown and would have to be characterized by collection of additional soil samples and the installation and monitoring of groundwater wells. In addition, an underground fuel pipeline is located at the proposed Irvington Station (Figure 3.3-1). Impacts associated with discovery of hazardous materials at this portion of the alignment are considered to be significant. Impacts associated with the discovery of hazardous materials at other sites along this portion of the alignment are considered to be potentially significant.
- **Proposed Irvington Station to Proposed Warm Springs Station.** An underground fuel pipeline is located along the eastern boundary of the alignment between the proposed Irvington and Warm Springs stations (Figure 3.3-1). Regulatory agency files indicated that hazardous materials were identified in the subsurface at sites 9, 10, 11, and 13 along this section of the alignment (Figure 3.3-1 and Table 3.3-1). Site investigation activities are in progress or required for sites 9 and 10. No information regarding site investigations was available for site 11; the City of Fremont has granted closure for site 13 (Figure 3.3-1 and Table 3.3-1).

Results of chemical analyses of soil and groundwater samples collected from locations within this proposed section of the alignment identified compounds above laboratory detection limits at two locations (samples A-2 and A-4) (Figure 3.3-2).<sup>2</sup> The extent of subsurface contamination identified along this section of the alignment is unknown and would have to be characterized by collection of additional soil samples and the potential installation of groundwater wells and monitoring of groundwater. Impacts associated with discovery of hazardous materials at this portion of the proposed alignment are considered to be significant. Impacts associated with the possible

---

<sup>1</sup> Kal Krishnan Consulting Services, 1991, op. cit.

<sup>2</sup> Ibid.

discovery of hazardous materials at other sites along this portion of the alignment are considered to be potentially significant.

- **Proposed Warm Springs Station.** According to regulatory agency file review, subsurface hazardous materials were not identified at sites located at the proposed Warm Springs Station (Figure 3.3-1). Underground fuel pipelines are present at the proposed station location (Figure 3.3-1). A groundwater sample collected from this location did not contain chemical compounds above laboratory detection limits (Figure 3.3-2).<sup>1</sup> Impacts associated with discovery of hazardous materials at this location along the project alignment are considered to be potentially significant.
- **Proposed Warm Springs Station to Proposed South Warm Springs Station.** Hazardous materials were identified in the subsurface at six locations (sites 18, 21, 22, 23, 24, and 25 on Figure 3.3-1 and Table 3.3-1) along this portion of the proposed alignment, according to agency file review. Site investigations are in progress or required at sites 22, 23, and 25. No information regarding site investigation activities was available in agency records for sites 18, 21, and 24. An underground fuel pipeline is located along a portion of the section between the proposed Warm Springs and South Warm Springs stations, on the eastern boundary (Figure 3.3-1).

Petroleum hydrocarbons were identified in the soils and groundwater at four sample locations (A-5, A-6, A-7 and A-9) along this portion of the proposed alignment (Figure 3.3-2).<sup>2</sup> The extent of subsurface contamination identified at this section is unknown and would have to be characterized by the additional collection of soil samples and the possible installation and monitoring of groundwater wells. Impacts associated with discovery of hazardous materials along this portion of the proposed alignment are considered to be significant.

- **Proposed South Warm Springs Station.** Sites 26, 27, 28, 29, 30, and 31 shown on Figure 3.3-1 and described in Table 3.3-1 could potentially impact construction of the Proposed Project. Although the ACWD granted closure for site 26 and a closure report was prepared for site 28, site investigation activities are in progress at site 27

---

<sup>1</sup> Kal Krishnan Consulting Services, 1991, op. cit.

<sup>2</sup> Ibid.

(Figure 3.3-1 and Table 3.3-1). No site investigation information was available in agency records for sites 29, 30, and 31.

Chemical analyses of soil and groundwater samples collected from locations at the proposed station identified chemical compounds at levels above the laboratory detection limits at one of the two sample locations (A-12, Figure 3.3-2).<sup>1</sup> The extent of subsurface contamination at this location is unknown and would have to be characterized by the additional collection of soil samples and the installation and monitoring of groundwater wells. Impacts associated with discovery of hazardous materials at this location along the Proposed Project alignment are considered to be significant.

**Mitigation Measures for Construction Period Impacts.** To mitigate significant impacts associated with exposure to hazardous materials during construction of the Proposed Project, the extent of known contamination at certain portions of the project alignment where grading, excavation, or dewatering is likely to occur, should be characterized and remediated prior to or during project development. The portions of the alignment which require further characterization and possibly remediation activities (should grading, excavation, or dewatering activities occur) include: (1) the proposed Irvington Station location, (2) the proposed Irvington Station to the proposed Warm Springs Station, (3) the proposed Warm Springs stations to the proposed South Warm Springs Station, and (4) the proposed South Warm Springs Station location. Remediation activities would be conducted in accordance with applicable local, state, and federal regulatory requirements.

If materials are encountered during construction which are at levels above established levels contained in the site safety plan, work should cease until a qualified professional has evaluated the collected data. Specific laboratory tests should be performed to determine contaminate concentrations. Once the contaminate concentration is determined, the identification of which landfill type (i.e. Class I, II or III) can be made.

Contaminated soils or groundwater excavated or extracted during construction activities would be managed in accordance with applicable regulatory requirements and regulatory agency oversight. Remediation of soils could include excavation and on- or off-site treatment/disposal

---

<sup>1</sup> Ibid.

### 3.3 Hazardous Materials

or in-place treatment of the affected soils. Remediation of groundwater could include in-situ treatment or extraction and treatment; disposal of treated waters could be to surface waters or the sanitary sewer system. Disposal options for contaminated soil and groundwater (i.e., on- or off-site treatment and/or disposal) would depend on the specific chemicals present and the levels of concentration. If contaminated soils were disposed of off-site, the contaminated levels in the soils would determine the disposal in Class I, II, or III landfills. The State of California has Class I, II and III landfills throughout the state. Each type of landfill has acceptance criteria concerning specific contaminants accepted and ranges of contaminant levels of concentration. Potential accidents with trucks carrying contaminated soils will be mitigated by applicable regulations for transport.

Investigation and remediation of contaminated subsurface materials prior to property acquisition would satisfy requirements of CTC Resolution G-91-2, as well as reduce impacts of exposure of workers to hazardous materials during project construction.

All construction activities, including excavation and grading, should be conducted in accordance with a site-specific health and safety plan. The site safety plan, which would be prepared by a qualified professional, would be specific to each portion of the project alignment and would include a description of the potential for exposure to specific hazardous materials within the project corridor and the associated health risks. The plan would also provide site safety guidelines, delineation of action levels for personal protective gear, and emergency response procedures. The site safety plan would be reviewed by all construction workers prior to commencement of project development activities. Access onto those portions of the project site where significant impacts have been identified would be restricted during construction activities to minimize potential exposure of the general public to hazardous materials.

Prior to construction near the underground fuel pipelines, the exact location of the lines should be accurately established (e.g., accurate maps from the owner or operator or geophysical surveys). Potential hazards associated with rupture of the pipelines or discovery of hazardous materials releases from the pipelines should be included in the site health and safety plan.

#### **Cumulative Impacts**

Although operation of the Proposed Project would not involve the handling of hazardous materials, it is expected that other development in the vicinity of the Proposed Project could result in increased handling and storage of hazardous materials. Projected increases in high-tech manufacturing within the City of Fremont is expected to result in increase use of hazardous

### 3.3 Hazardous Materials

substances and increased production of hazardous wastes.<sup>1</sup> Potential citing of hazardous waste transfer, storage, and disposal facilities could also contribute to waste stream.

The increased management of hazardous materials will increase the transportation of hazardous materials within the City of Fremont. The expected increased volume of transported waste implies an increased potential for accidental spillage of these materials during loading, unloading, or transporting the materials on roadways within the City. Expected increases in traffic in city roadways will heighten the potential for accidents during transport.

Planning that provides for minimum feasible risk of lives and property due to use, storage and transportation of hazardous materials is reflected in the Fremont General Plan. Policies of the Fremont General Plan, as implemented, would mitigate cumulative impact. Policy HS 6.2.1 states that the City will require that hazardous materials be managed in a manner that minimizes risk to workers and residents. The implementation actions for this policy include enforcement of the provisions of the City's Hazardous Materials Ordinance and periodic review and evaluation of the City's truck routes to ensure minimum possible risk to the community from the transport of hazardous materials on City streets. Also, the potential impacts of increased management of hazardous materials would be mitigated by compliance with federal, state, and local laws and regulations.

#### **Residual Impacts After Mitigation**

The purpose of the mitigation measures is to minimize possible health and safety risks associated with exposure of hazardous materials and also to minimize impacts associated with interruption or delay of on-going site remediation or investigation activities. Implementation of the recommended measures would mitigate potential impacts identified in this section such that residual impacts after mitigation would be reduced to a less than significant level.

#### **Impacts of Design Options**

The implementation of the Design Options would not result in different impacts or mitigations than those shown in the Proposed Project.

---

<sup>1</sup> City of Fremont, *Fremont General Plan*, Preliminary Draft, March 1990.

**3.3.3 IMPACTS OF ALTERNATIVE 1: No Project and No Transportation Improvements (status quo)**

This alternative would result in no change in existing conditions. Potential impacts associated with the management of hazardous materials within the project corridor would not occur under this alternative.

**3.3.4 IMPACTS OF ALTERNATIVE 2: No Project, Programmed Transportation Improvements**

This alternative would not include construction of a BART Warm Springs extension. Potential impacts associated with the management of hazardous materials within the project corridor would not occur under this alternative.

**3.3.5 IMPACTS OF ALTERNATIVE 3: Transportation Systems Management (TSM)**

This alternative would not include construction of a BART Warm Springs extension. Potential impacts associated with the management of hazardous materials within the project corridor would not occur under this alternative.

**3.3.6 IMPACTS OF ALTERNATIVES 4 & 5**

Under these alternatives and associated design options, potential direct, construction, and cumulative impacts would be the same as for the Proposed Project, except that possible discovery of hazardous materials south of the proposed Warm Springs Station tailtrack including the subsurface at the South Warm Springs Station would not occur.

**3.3.7 IMPACTS OF ALTERNATIVES 6 & 7**

Potential direct, construction, and cumulative impacts associated with the management of hazardous materials would be similar to those identified for the Proposed Project; however, health and safety risks posed by exposure to contaminated subsurface soils or groundwater would

be reduced by elimination of the Irvington Station since grading, excavation, and dewatering activities would not occur at that location.

**3.3.8 IMPACTS OF ALTERNATIVE 8: A 7.8-Mile BART Extension along Osgood Road and Warm Springs Boulevard, with Two Stations (no Irvington Station)**

Under this alternative, potential direct, construction, and cumulative impacts associated with the management of hazardous materials would be similar to those identified for the Proposed Project; however, this alternative alignment would be located east of the Proposed Project alignment, and there are fewer known sites associated with hazardous materials that might have affected the subsurface located along the alternative alignment. Soil and groundwater quality along this alternative alignment is unknown, as soil and groundwater samples were not collected from the alternative alignment. Health and safety risks posed by exposure to contaminated subsurface materials at the Irvington Station would not occur because there would be no construction activities at the Irvington Station under this alternative. Although construction of the South Warm Springs Station would occur at a different location than the Proposed Project location, impacts associated with discovery of and exposure to subsurface hazardous materials would be similar to those identified for the Proposed Project.

**3.3.9 IMPACTS OF ALTERNATIVE 9: A 5.4-Mile BART Extension with One Station (Warm Springs)**

Potential direct, construction, and cumulative impacts associated with the management of hazardous materials would be similar to those identified for the Proposed Project; however, since this alternative does not include the proposed Irvington or South Warm Springs stations, health and safety risks posed by exposure to contaminated subsurface soils or groundwater at these locations and along the alignment south of the Warm Springs Station tailtracks would be minimized if grading, excavation, and dewatering activities were not to occur at these locations.

**3.3.10 IMPACTS OF ALTERNATIVE 10: A 7.8-Mile BART Extension with One Station (South Warm Springs)**

Potential direct, construction, and cumulative impacts associated with the management of hazardous materials would be similar to those identified for the Proposed Project; however,

### 3.3 Hazardous Materials

because this alternative does not include the proposed Irvington or Warm Springs stations, health and safety risks posed by exposure to contaminated subsurface soils or groundwater at these locations would be minimized if grading, excavation, and dewatering activities were not to occur at these locations.

#### **3.3.11 IMPACTS OF ALTERNATIVE 11: A 7.8-Mile BART Extension with Two Stations (no Warm Springs Station)**

Potential direct, construction, and cumulative impacts associated with the management of hazardous materials would be similar to those identified for the Proposed Project; however, because this alternative does not include the proposed Warm Springs station, health and safety risks posed by exposure to contaminated subsurface soils or groundwater at this location would be minimized if grading, excavation, and dewatering activities were not to occur at this location.



## 3.4 HYDROLOGY

### 3.4.1 SETTING AND EXISTING CONDITIONS

#### Surface Hydrology and Flooding

The surface hydrology of eastern Fremont is characterized by westward flowing streams draining the foothills of the Diablo Range. The climate of the area is temperate and influenced by the proximity of the San Francisco Bay, located to the west. The mean annual temperature is 57 degrees (F.), with a maximum annual temperature of 68 degrees and a minimum annual temperature of 47 degrees. The mean annual rainfall is approximately 18 inches, most of which falls in the rainy season between October and April. In general, the further inland and the higher the elevation, the more annual precipitation increases.<sup>1</sup> The 24-hour, 15-year rainfall event is 3.20 inches; the 100-year event is 4.46 inches.<sup>2</sup>

The lower reaches of the streams have been modified and constructed as storm drainage channels, designed to convey stormwater flow through the urbanized area. The proposed Warm Springs Extension project crosses 13 major drainage lines (Figure 3.4-1). The agencies responsible for the design and maintenance of these flood control facilities are the Alameda County Flood Control and Water Conservation District (ACFCWCD Zones 5 and 6) of the Alameda County Public Works Agency (ACPWA) and the City of Fremont Public Works Department (FPWD).

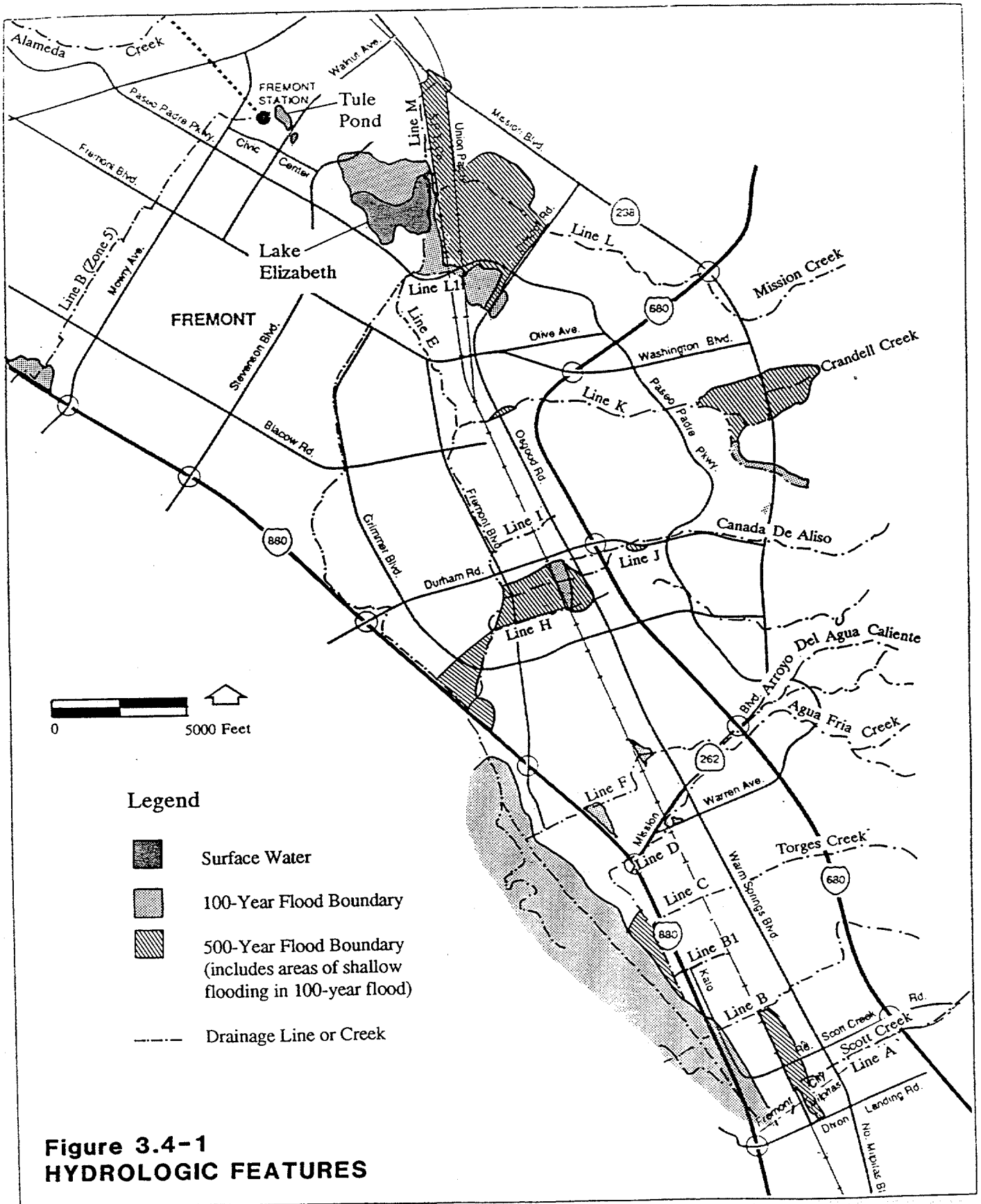
In general, the existing drainage structures have been sized to effectively convey the stormwater flows of the 15-year stormwater runoff event.<sup>3</sup> The County of Alameda also requires that drainage facilities for primary drainage areas (greater than 50 acres) be designed to convey the 100-year storm. Each of the major streams and associated constructed drainage facilities have been given drainage line designations (Figure 3.4-1). The characteristics of the drainage lines crossed by the proposed Warm Springs Extension project are presented in Table 3.4-1. The major stream channel in the project vicinity is Alameda Creek, located 0.8 miles north of the project site. The channel of Alameda Creek has been modified to convey flood flows and is

---

<sup>1</sup> U.S. Department of Agriculture, 1981, *Soil Survey of Alameda County, California, western part*: Soil Conservation Service, 103p.

<sup>2</sup> Bay Area Rapid Transit Consultants (BATC), 1990a, *Tule Pond Hydrology Study*, prepared for Bay Area Rapid Transit District, 11p. plus tables and figures.

<sup>3</sup> Otsuka, A., 1991, Engineer, Alameda County Flood Control and Water Conservation District, personal communication, 22 March.



**Figure 3.4-1  
HYDROLOGIC FEATURES**

SOURCE: Baseline Environmental Consulting, 1991

**Table 3.4-1  
Drainage Line Characteristics  
Warm Springs BART Extension**

Drainage Line	Associated Watershed	Total Drainage Area (Mi <sup>2</sup> ) <sup>a</sup>	Crossing Location (BART Station)	Conveyance Structure		Characteristics at Crossing	
				WPRR	SPRR	15-Year Peak Flow <sup>b</sup> (cfs)	100-Year Peak Flow (cfs)
L	Mission Creek	10.2	None	16' Channel	16' Channel	2,086	4,278
L-1	Mission Creek	0.9	2300+80	NA	NA	151	269
K	Crandell Creek	3.3	2359+60	6'x3.5' Box	6'x5' Arch	606	NA
I	Canada de Aliso	NA	2404+50	34" Pipe	7'x6' Box	180	245
J	Canada de Aliso	1.6	2423+50	72" Pipe	72" Pipe	412	556
H	Canada de Aliso	1.3	2432+75 Box Culvert	Modified Box Culvert	Modified	436	589
F	Arroyo del Agua Caliente	2.7	2492+00	8'x6' Box	81" Pipe	586	NA
D	Agua Fria Creek	2.4	2521+80	NA	NA	NA	NA
C	Torges Creek	4.4	2548+50	11" Culvert	13'x2.5 Trestle	335	460
B	Scott Creek	5.6	2592+90	72" Pipe	72" Pipe	332	555
B1	Targus Creek	0.3	NA	NA	NA	NA	140
A	Scott Creek	2.1	2620+20	16' Concrete	16' Concrete Channel	309	579

<sup>a</sup> Source: FEMA 1987

<sup>b</sup> Source: ACFCWCD Files

Notes: NA = Not Applicable

Mi<sup>2</sup> = Square Mile

cfs = cubic feet p

### 3.4 Hydrology

integrated into an artificial groundwater recharge program operated by the Alameda County Water District (ACWD). The Proposed Project alignment is outside the 100-year floodplain of Alameda Creek and the recharge facility boundaries.

Mission Creek (Line L) drains westward through the northern portion of the Mission San Jose District into the northeast portion of Lake Elizabeth (Figure 3.4-1). West of the Southern Pacific Transportation Company (SPTCo) tracks, Line L meets Line M which drains Morrison Canyon. Lake Elizabeth, located in Fremont's Central Park is a modified natural lagoon (formerly called Stiver's Lagoon); the lake is used for recreation and flood control. The 100-year flood flows into the lake would cause an approximate 144 percent expansion of the surface area of the lake, including flooding of a portion of Stevenson Boulevard.<sup>1</sup> Shallow flooding north of Paseo Padre Parkway between the Union Pacific Railroad (UPRR) and SPTCo tracks is expected during 100-year flooding as the result of inadequate channel capacity of the drainage channels in the area and overflow from Lake Elizabeth. Laguna Creek (Line E) forms the outlet to Lake Elizabeth, flowing southward from the southeast corner of the lake. The 100-year flood flows are contained within the Line E channel in the area of the Proposed Project.<sup>2</sup>

The Tule Pond, formerly called Tyson's Lagoon, is a natural depression formed along the Hayward Fault; the pond is used for flood control, and it supports wetland habitat. The Tule Pond is located at the northern end of the Proposed Project alignment, east of the parking area of the Fremont BART Station, and extends north and south of Walnut Avenue. The northern and southern portions of the pond are connected by two 18-inch culverts beneath Walnut Avenue. The pond collects runoff from a 672-acre drainage area. The major portion (89 percent) of the drainage area delivers eastward-flowing runoff to the north pond. The north pond is drained westward by drainage Line B (Figure 3.4-1) located at the northwest corner of the pond. No major drainage lines flow into the south pond. The south pond would drain to the north pond.<sup>3</sup>

Crandell Creek (Line K) drains the (Figure 3.4-1) southern portion of the Mission San Jose District and crosses the Proposed Project alignment at Station 2359+60 as a 72-inch concrete pipe. Shallow flooding along this channel during a 100-year event is expected east and west of

---

<sup>1</sup> Federal Emergency Management Agency (FEMA), 1983, Flood Insurance Rate Map, Community Panel Number 065028-0030D.

<sup>2</sup> Ibid.

<sup>3</sup> BATC, 1990a.

the Proposed Project alignment as the result of inadequate channel capacity and continued urban development.<sup>1</sup>

Flood flows of the Canada del Aliso drainage are conveyed to the UPRR and SPTCo tracks by drainage Line J. Lines J and H (850 feet to the south) convey flows beneath the tracks. Inadequate culverts at both locations contribute to flooding east of the tracks between Lines J and H during high flows.<sup>2</sup>

Drainage Line F conveys the flow of Arroyo del Agua Caliente beneath the UPRR and SPTCo tracks through concrete box structures. Flooding during a 100-year event is expected in a localized area east of the UPRR due to inadequate sizing of these culverts. Erosion problems along the Line F channel have been identified by the ACFCWCD<sup>3</sup> west of the SPTCo tracks and I-880.

Agua Fria Creek (Line D) crosses the UPRR and SPTCo tracks just north of East Warren Avenue. Localized flooding during the 100-year event in the area of this crossing is expected due to an inadequate culvert. The 100-year flows of the Torges Creek drainage are expected to be contained within the Line C drainage channel. Drainage Line B-1, which drains the area west of the UPRR tracks between Line C to the north and Line B to the south is also expected to contain the 100-year runoff event.<sup>4</sup>

At the southern end of the Proposed Project, Lines B and A capture runoff from the lower reaches of the Scott Creek drainage. Shallow flooding (Zone B) during the 100-year flood is expected east of the UPRR track from Line B to south of Line A. The cause of such flooding has been identified as partial blockage of the Line B culvert and inadequate size of the Line A culvert beneath the railroad tracks.<sup>5</sup>

---

<sup>1</sup> FEMA, 1987, *Flood Insurance Study, City of Fremont, California, Alameda County*, Community Number 065028, 33p.

<sup>2</sup> Ibid.

<sup>3</sup> Otsuka, 1991, *op.cit.*

<sup>4</sup> FEMA, 1987, *op.cit.*

<sup>5</sup> Ibid.

### Subsurface Hydrology

The northern portion of the Proposed Project alignment is located within the eastern portion of the Niles subarea of the South Bay Ground Water Basin.<sup>1</sup> The Niles subarea is considered the most important groundwater resource in Alameda County.<sup>2</sup> The basin provides approximately 50 percent of the Alameda County Water District's water supply.<sup>3</sup>

The southern portion of the Proposed Project is partially within the Warm Springs subareas of the South Bay Groundwater Basin. Warm Springs subarea is west of the Hayward Fault Zone. The alluvial deposits of Warm Springs Alluvial Apron contain thin, discontinuous, fine-grained aquifers which produce moderately low groundwater yields to wells.<sup>4</sup> Groundwater is typically encountered within 50 feet of the ground surface.<sup>5</sup> The groundwater flow is generally directed westward, and limited recharge of the Niles subarea occurs from water discharging from the Warm Springs subarea and the Mission Uplands further to the east.<sup>6</sup>

At least three relatively shallow, distinct, productive water-bearing zones, or aquifers, are recognized within the Niles Cone: the Newark, Centerville, and Fremont aquifers. The aquifers, generally coarse-grained sand and gravel deposits, are separated by finer-grained, less permeable clayey silty deposits. The uppermost water-bearing zone, the Newark Aquifer, is an extensive flat-lying gravelly layer, which is encountered at depths ranging from 60 to 140 feet below the surface.<sup>7</sup> The permeable deposits are thickest near the Hayward Fault and thin to less than 20 feet thick toward the Bay. The thickness of fine-grained deposits of the overlying Newark Aquiclude<sup>8</sup> increases westward. In the area of the Proposed Project alignment, the

---

<sup>1</sup> California Department of Water Resources (DWR), 1967, *Evaluation of Groundwater Resources: South Bay* (Appendix A: Geology): DWR Bulletin 118-1.

<sup>2</sup> Ibid.

<sup>3</sup> Alameda County Water District (ACWD), 1990, *Groundwater Monitoring Report*, Fall 1990, 4p. and four appendices.

<sup>4</sup> DWR, 1968, *Evaluation of Groundwater Resources; South Bay* (Volume I: Fremont Study Area); DWR Bulletin No. 118-1.

<sup>5</sup> BATC, 1989, op. cit.

<sup>6</sup> DWR, 1968, op. cit.

<sup>7</sup> DWR, 1967, op. cit.

<sup>8</sup> An aquiclude is a geologic stratum of low permeability which is incapable of transmitting significant quantities of water under ordinary hydraulic gradients.

Newark Aquiclude can be less than 20 feet thick. Isolated permeable zones within the near surface fine-grained sediments are typically considered subunits within the Newark Aquiclude.<sup>1</sup>

The Hayward Fault zone forms a significant hydrologic barrier within the Niles subarea. Motion along the fault causes shearing within the sediment which has generated a near vertical zone of fine-grained material. The low permeability of the fault zone forms a boundary which impounds the westward flow of groundwater. This impoundment causes groundwater levels east of the fault to be encountered at considerably higher elevations (i.e., shallower depths) than those west of the fault. The groundwater levels can vary from 50 to 100 feet across the fault, and fluctuate seasonally.<sup>2</sup> During geotechnical investigations near the Fremont BART station, groundwater was encountered northeast of the fault zone at an approximate elevation of 39 feet above mean sea level (msl) and at elevation -14 feet msl southwest of the fault.<sup>3</sup>

Dams have been constructed within the Alameda Creek watershed to impound water supply reservoirs. These reservoirs include the Calaveras, San Antonio, and Del Valle reservoirs. Failure of the impounding dams could result in flooding of the Fremont area.

Northeast of the fault, the uppermost aquifer is referred to as the "above the Hayward fault" (AHF) aquifer. The aquifer materials are highly permeable gravels which provide high groundwater yield to wells.<sup>4</sup> The overlying fine-grained sediments are typically thin and the aquifer is largely unconfined.<sup>5</sup> Permeable gravel deposits are typically encountered at depths less than 20 feet below the surface.<sup>6</sup> Groundwater is typically encountered at depths ranging from 5 to 25 feet below the ground surface. Locally elevated groundwater levels in the vicinity

---

<sup>1</sup> Duerig, G.F., 1991, Engineer, Alameda County Water District, personal communication, 22 March.

<sup>2</sup> DWR, 1967, op. cit.

<sup>3</sup> Cooper-Clark and Associates, 1968, *Foundation Investigation, portion of southern Alameda line, station 2137+00+station 2260+20, Fremont, Alameda County, California*, unpublished report, prepared for San Francisco, California, 35p.

<sup>4</sup> DWR, 1967, op. cit.

<sup>5</sup> Duerig, 1991, op. cit.

<sup>6</sup> BATC, 1989, *Available Geotechnical Data Report for the Warm Springs Extension*, unpublished report, prepared for the San Francisco Bay Area Rapid Transit District, 43p. + Figures and Tables.

of Tule Pond and Lake Elizabeth indicate that these surface water bodies recharge the underlying aquifer.<sup>1,2</sup> In general, groundwater flow within the AHF aquifer is directed toward the west. Complications to this general trend include the influence of pumping at the Peralta-Tyson well field operated by the ACWD and complex flow along the fault zone.<sup>3</sup>

West of the Hayward Fault, the groundwater flow direction is generally west-northwestward toward the Bay.<sup>4</sup> The aquifer is locally confined by the thick overlying fine-grained deposits of the Newark Aquiclude. The shallow Newark Aquifer is the main conduit of eastward migrating saline groundwater from San Francisco Bay.<sup>5</sup> The low permeability of the overlying Newark Aquifer partially blocks the intrusion of salt water into the Newark Aquifer. Westward flow of fresh groundwater in the aquifer and the associated positive hydraulic head also inhibits salt water intrusion. High groundwater pumpage prior to the 1970s caused significant declines in groundwater levels, the development of a landward hydraulic gradient, and salt water intrusion into the aquifer. By the 1960s, the saline groundwater wedge had intruded up to five miles inland of the Bay and had affected the quality of the Newark and lower aquifers. Saline groundwater pumping and groundwater recharge along Alameda Creek, implemented by the ACWD, has been successful in raising the groundwater table to an elevation above sea level and reversing the trend of saline water intruding the aquifer.<sup>6</sup>

### Water Quality

The major water quality concern within the Niles subarea is the degradation of groundwater quality caused by salt water intrusion into the Newark Aquifer. The intrusion and mixing of saline water with the fresh groundwater caused increases in the concentration of total dissolved solids. As discussed in the previous section, salt water intrusion was caused by overdrafting of

---

<sup>1</sup> Woodward-Clyde and Associates, 1970, *Fremont Meadows active fault investigation and evaluation, Fremont, California*: Oakland, California, unpublished consulting report prepared for F.B. Burns and Associates, Project Number G-10396, 62p.

<sup>2</sup> Wahler Associates, 1985, *Geotechnical Investigation, Central Park improvements, Fremont, California*: unpublished consulting report prepared for Lowry and Associates, Project Number LRY-109A.

<sup>3</sup> Duerig, 1991, op. cit.

<sup>4</sup> ACWD, 1990, op. cit.

<sup>5</sup> DWR, 1967, op. cit.

<sup>6</sup> ACWD, 1990, op. cit.



groundwater from the Newark Aquifer. Elevated levels of chloride in the groundwater were identified in the early 1970s within the groundwater underlying the Fremont area.<sup>1</sup>

Remediation of the saline intrusion has resulted in a general decrease in chloride concentrations measured in wells within the Newark Aquifer. Water quality monitoring performed in the fall of 1990 suggests that chloride concentrations within the Newark Aquifer in the area of the proposed alignment are less than 250 parts per million and that the saline front has migrated westward.<sup>2</sup>

Elevated levels of nitrates and boron were identified in groundwater in the Fremont area. The source of nitrate is generally considered to be a combination of nitrate bearing minerals within the sediments of the area and discharges from waste water treatment facilities, including septic tanks.<sup>3</sup> Boron is also contained within the minerals of the sediments of the area. Discharge of contaminants to the subsurface from underground storage tanks and infiltration of surface spills are known within the Fremont area and contribute to water quality degradation. The locations of identified releases of hazardous materials are discussed in the Hazardous Materials Section of this report.

The quality of surface waters in the area is not monitored regularly. Discharges from municipal and industrial waste treatment and disposal facilities within the drainage areas may contribute contaminants to the streams.<sup>4</sup> Runoff from urbanized areas can contribute contaminants, including petroleum products and heavy metals.

### 3.4.2 IMPACTS OF PROPOSED PROJECT AND DESIGN OPTIONS AND MITIGATION MEASURES

CEQA Guidelines define significant hydrologic effects as those which would substantially degrade water quality, contaminate a public water supply, substantially degrade or deplete groundwater

---

<sup>1</sup> Webster, D.A., 1972, Map showing areas in the San Francisco Bay Region where nitrate, boron, and dissolved solids in groundwater may influence regional development, U.S. Geological Survey miscellaneous field studies MF432.

<sup>2</sup> ACWD, 1990, op. cit.

<sup>3</sup> Webster, 1972, op. cit.

<sup>4</sup> Ibid.

resources, interfere substantially with groundwater recharge, and/or cause substantial flooding, erosion or siltation.<sup>1</sup>

### **Direct Impacts**

**Reduction of Stormwater Storage in South Tule Pond.** The Proposed Project and all of the design options would include construction of an earthen embankment across the southern portion of Tule Pond south of Walnut Avenue. The "south pond" is a seasonal wetlands used for stormwater detention by the ACFCWCD. Construction of the embankment would result in loss of stormwater storage volume within the south pond. The embankment would replace approximately 10 acre-feet of volume of 100-year flood stormwater stored in the pond.<sup>2</sup> The loss of stormwater storage could cause flooding in the vicinity of Tule Pond, potentially affecting existing or future developments. This would be a significant effect of the project.

**Mitigation for Reduction of Stormwater Storage in South Tule Pond.** The loss of stormwater storage in south Tule Pond would be mitigated by providing increased storage volume in a different location within the drainage area serviced by the pond. Increased storage volume could be provided by excavation which would 1) expand or deepen the south pond, 2) expand or deepen the northern section of the pond, or 3) provide storage outside the existing ponds.

A study prepared for BART recommended excavation to expand the south pond which would replace the lost storage.<sup>3</sup> A specific plan for excavation has been presented to the ACFCWCD for review. The proposed excavation would extend the south pond westward as a narrow reservoir. The depression would be bounded by the housing development to the south and the proposed BART Warm Springs extension alignment to the north. The ACFCWCD has reviewed the plan and has agreed to work with BART on the proposed expansion of the south pond.<sup>4</sup> The south pond has been identified as a seasonal wetlands and excavation to expand or deepen the pond would require review by the California Department of Fish and Game (CFG) and the Army Corps of Engineers.

---

<sup>1</sup> Office of Planning and Research, Office of Permit Assistance, 1986, *The California Environmental Quality Act, Statutes and Guidelines*, Appendix G.

<sup>2</sup> BATC, 1990a, op. cit.

<sup>3</sup> Ibid.

<sup>4</sup> Lindsey, J.A., 1991, ACFCWCD Supervising Civil Engineer, letter to Ferrel Schell of BART, 6 February.

Replacement of the storage volume lost by construction of the Proposed Project would reduce this impact to an insignificant level. Appropriate implementation of the mitigation would need to be consistent with the flood control policies of the ACFWCD as well as in conjunction with mitigations outlined in Section 3.5, Ecosystems, for protection of wetlands resources.

**Structures within Flooding Zones.** The proposed alignment traverses several areas identified as being inundated during 100-year and 500-year flooding events. The areas within 100-year flooding zones include the area north and east of Lake Elizabeth and localized areas east of the proposed alignment crossings of drainage lines J, H, F, and A. Construction within the 100-year flood zone around Lake Elizabeth would include aerial spans and supports (Proposed Project and Design Options 2A and 3) or a subway structure (Design Options 1 and 2S). The supports for the aerial structure would incrementally reduce the stormwater storage volume available within the flood zone and may contribute to flooding in adjacent areas; however, this would not be considered a significant impact. Similarly, the top of the subway structure would be slightly above the lake bottom, which would incrementally reduce the lake's storage volume but would not result in a significant permanent loss of stormwater storage.

An aerial span is proposed for all design options of the Proposed Project through the flood zone between Lines J and H, south of Durham Road. The supports would not be constructed within the flood zone and therefore would not impact stormwater storage. The Proposed Project (all design options) would follow the existing at-grade railroad right-of-way across Lines F and A. The existing railway embankment is above the 100-year flood zone identified east of the tracks in these areas and would not reduce stormwater storage.

The Proposed Project and Design Options 2 and 3 would include construction of aerial supports in an area north of Paseo Padre Parkway which is expected to be flooded to shallow depths during a 100-year storm and during a 500-year storm. The supports would remove an insignificant volume of flood storage in this area.

Under existing conditions, shallow flooding is expected during 100-year storm (FEMA Zone B) in the area of the proposed South Warm Springs Station. Inadequate culverts for drainage Lines A and B have been identified as the cause of the flooding.<sup>1</sup> The construction of parking facilities for the proposed South Warm Springs Station could reduce 100-year stormwater storage. The parking area is located within a zone identified as potentially flooded to shallow

---

<sup>1</sup> BATC, 1990b, *BART Extension Program Design Criteria*, Volume I: Structural, 202p.

depths during the 100-year storm event. If the elevation of the proposed parking area is above flooding elevation, flood water storage would be decreased and flooding of other areas could occur which would be a significant impact.

**Mitigation for Structures in Flooding Zones.** The localized flooding along the Proposed Project alignment or South Warm Springs Station and parking area would be mitigated to an insignificant level by improvements to drainage structures which cross the alignment. The drainage lines crossing at-grade segments of the alignment would be improved to convey the 100-year storm flows as required by the BART Extensions Program design criteria.<sup>1</sup> These criteria require that "all designs shall consider ultimate development trends in the area".<sup>2</sup> Improvement to the culverts for Lines A and B would mitigate flooding of the area of the proposed South Warm Springs Station parking facilities and the proposed rail car wash facility. The design of drainage structures would conform with the criteria of the Alameda Public Works Agency (ACPWA).<sup>3</sup> The design and construction of the structures would be subject to approval by the ACPWA and the City of Fremont Public Works Department (FPWD). These mitigations should reduce the impacts below a level of significance.

During operation, the drainage facilities would be inspected by the ACFCWCD annually and during major storms to ensure that the drainage facilities are operating effectively. Any identified problems would be corrected as soon as possible to prevent flooding hazards.

**Increased Surface Water Runoff.** The Proposed Project and all design options would involve construction of impervious surfaces in areas which are presently undeveloped. The additional impervious cover would reduce the amount of stormwater infiltration and would increase the volume of surface water runoff. Increased surface water runoff would increase stormwater flows and would incrementally increase the potential for flooding along drainage lines.

The most significant addition of impervious cover would result from the construction of the parking areas, facilities, and associated roadways and sidewalks for the three proposed stations. Assuming that 90 percent of the area occupied by the stations and parking facilities are to be covered by impervious surfaces, the net increase of impervious cover would be approximately

---

<sup>1</sup> Ibid.

<sup>2</sup> Ibid., p. I.8-8.

<sup>3</sup> Alameda County Public Works Agency (ACPWA), 1987, *Hydrology and Hydraulics Criteria Summary for Western Alameda County*.

29.4 acres at the Irvington Station, 33.0 acres at the Warm Springs Station, and 38.7 acres at the South Warm Springs Station.

Assuming that project construction does not significantly alter ground surface slopes, the covering of existing pervious surfaces with impervious pavements and buildings would result in an approximate 200 percent increase in runoff discharge from the station areas. The concrete slabs used in the construction of transition segments of the trackway and as foundation mats would increase runoff by a similar amount in the construction area. Construction of the aerial segments of the alignment would increase runoff by approximately 15 percent. At-grade segments of the alignment constructed on existing or modified existing trackway constructed on highly permeable ballast would not increase runoff from these areas. Subway construction (Design Option 1 and 2S) would not significantly increase runoff. The increased surface water runoff, and the resultant increased potential for flooding in areas downstream of the Proposed Project, is a significant impact.

**Mitigation for Increased Surface Water Runoff.** The increased surface runoff would be mitigated to an insignificant level by increasing the capacity of inadequate culverts at drainage line crossings currently expected to contribute to 100-year flooding and appropriate design of parking and roadway drainage which would minimize concentration of runoff. The proposed mitigation of flooding hazards discussed above would consider the increased runoff generated by the Proposed Project and ultimate development of the area. The BART design criteria require that drainageways which collect runoff from BART facilities be designed to convey the surface flow generated by a 10-year storm event.

The design of drainage facilities for the parking and roadway areas would consider the appropriateness of detention basins to reduce the rate at which runoff is delivered to the surface water drainage system. The amount of runoff could also be reduced by the use of pervious pavements to increase infiltration. The design of all parking and roadway areas would be reviewed and approved by the ACPWA and FPWD prior to construction. The implementation of these mitigations should reduce the impacts of increased surface runoff below a level of significance.

**Poor Drainage.** Portions of the Project alignment may be subject to poor surface water drainage or high groundwater levels which may cause adverse foundation conditions. The areas north of Paseo Padre Parkway and the area of the proposed South Warm Springs Station are subject to shallow flooding during the 100-year storm event. Construction of some of the project elements may result in localized ponding of stormwater runoff. The soils along the

entire alignment have low permeability and infiltration is slow. The ponding of surface water could reduce soil strength and increase the potential for swelling of expansive clays, potentially adverse foundation conditions. Shallow groundwater in the area of Tule Pond and around Lake Elizabeth could also produce adverse foundation conditions. Subgrade sections of the Proposed Project may also intercept shallow perched groundwater. The impacts of poor drainage would be significant.

**Mitigation of Poor Drainage.** Swales or drainage ditches could be designed to drain surface water away from all structures and into existing drainage lines. Runoff from all structures could be directed into storm drains or swales to prevent ponding above the foundations of the structures. The BART Extensions Program design criteria requires underdrains for structures in areas where groundwater may adversely affect the structural stability.<sup>1</sup> These mitigations would reduce the potential impacts of poor drainage to an insignificant level.

**Modification of Groundwater Conditions.** The construction and operation of a subway structure through Central Park (proposed in Design Options 1 and 2S) could result in the modification of hydrogeologic conditions. Groundwater within the "above the Hayward Fault" (AHF) aquifer has been encountered at depths above the bottom of the proposed subway structure. North of Paseo Padre Parkway, groundwater levels are reported to be as shallow as five feet below the ground surface. The bottom of the proposed subway would be 15 to 20 feet below the ground surface in this area. Construction of a subway likely would require dewatering system installation during construction to reduce the potential for failure of saturated sediments. The subway structure, if constructed to prevent seepage of groundwater into the subway tunnel, could inhibit the general westward flow of groundwater. The possibility of this impact would be increased if the bottom of the subway is constructed within fine-grained low permeability sediments which would inhibit groundwater flow beneath the subway.

The blockage of groundwater flow could result in increased groundwater levels near the subway. The potential impacts of the increased groundwater levels on the Proposed Project would be greater hydrostatic pressures on the buried subway structure and potentially adverse foundation conditions (e.g., reduction of soil strength and increased shrink-swell potential) for foundations of surface structures.

---

<sup>1</sup> BATC, 1990b, op. cit., p. I8-18.

If not properly mitigated, the potential impact of increased water levels and higher hydrostatic pressures would be a significant impact on the stability of structures. The impedance of flow past the subway structure may cause changes in the direction of groundwater flow in the area surrounding the proposed alignment. The influence of dewatering on groundwater levels and groundwater directions is expected to be localized and would not likely present adverse impacts on the performance of water supply wells.

**Mitigation of Modification of Groundwater Conditions.** To mitigate potential increases in groundwater levels in areas where the subway would be constructed at depths below the groundwater table, the subway would be designed to resist expected hydrostatic pressures and buoyant forces. The BART Extension Program design criteria require that cut-and-cover structures have a factor of safety against flotation<sup>1</sup> of 1.03 during construction and 1.07 following construction.<sup>2</sup> The subway design would consider the appropriateness of drains to transmit water beneath the subway sections underlain by low permeability materials to allow equalization of water levels east and west of the subway. These mitigation measures would reduce the impact of subway construction on groundwater levels and groundwater flow to an insignificant level.

**Degradation of Surface Water Quality.** The construction of large parking facilities for the three stations proposed for all of the design options of the Proposed Project would increase vehicular traffic and parking on nearby roadway and parking at the stations. The increased traffic and parking would contribute increased pollutant loads to storm runoff from the parking and roadway surfaces; this would be a significant impact. Hydrocarbons and trace metals are the major pollutants associated with this type of land use.

**Mitigation of Water Quality Degradation.** The potential increases in urban runoff pollutant loads related to construction of parking and roadway areas can be mitigated to a level less than significant by proper management practices and special design considerations. Specific management practices for impermeable surfaces may be required by the Regional Water Quality Control Board (RWQCB) as part of non-point source NPDES permits. In Alameda County, the ACFCWCD will be the lead NPDES permit holder. ACFCWCD may be required to institute best management practices as part of the conditions of the NPDES permit. It is currently unknown what kind of practices would be required of BART or other land owners

---

<sup>1</sup> Factor of Safety is the ratio of forces resisting to forces causing flotation. Structures with ratios above 1.00 are not buoyant.

<sup>2</sup> BATC, 1990c, *BART Extensions Program Design Criteria*, Volume II: Structural.

within Alameda County to control non-point discharges. BART would coordinate management practices with Alameda County to ensure compliance with future requirements.

Any management practices that would be required, could be supplemented by parking and roadway design elements which would help to reduce runoff. Runoff detention structures could be designed to include sedimentation chambers, also called water quality inlets, to allow potentially contaminated sediments to be removed from the runoff. These chambers could be cleaned out semi-annually to ensure proper functioning of the facilities. The sediments removed from the inlets would need to be properly disposed. Wherever possible, pervious pavements should be used to increase infiltration and reduce runoff. The pervious pavement would be constructed in areas not used by vehicles to reduce potential infiltration of contaminated runoff. The implementation of these mitigations would reduce the impacts of water quality below a level of significance.

#### **Cumulative Impacts**

**Increased Urban Runoff.** The construction of additional impervious surfaces for future urban developments, including the Proposed Project, would result in increased stormwater discharges in the Fremont area. The BART extension project also may stimulate local growth by providing service to the south Fremont area. Increased urban runoff could potentially contribute to existing flooding problems and increased surface water pollution which would be a significant impact.

**Mitigation of Increased Urban Runoff.** The ACFCWCD and FPWD would cooperate to ensure that adequate stormwater drainage is provided for all new developments and that appropriate flood control improvements are constructed. The potential discharge of pollution associated with urban runoff would be mitigated below a level of significance by the implementation of management programs required by the Non-Point-Source National Pollutant Discharge system permit process. These programs would be implemented by the ACPWA and the FPWD.

#### **Construction Impacts**

**Increased Erosion and Sedimentation.** The Proposed Project and all design options would involve significant excavations and earthen fill construction. The most significant excavations would result from the construction of the subway structure proposed in Design Options 1 and 2S. The construction of the Irvington Station and below-grade transition sections north and



south of the station would have similar impacts. The Proposed Project includes construction of a large fill embankment south of Walnut Avenue. Construction of transition sections to aerial sections would also involve construction of earthen fills. These major earthworks construction projects would not produce significant erosion and sedimentation problems if properly designed, constructed and maintained. Stockpiles of excavated soil and imported fill, if properly managed, also would not be sources of sedimentation. Erosion and sedimentation, if it were to occur, could result in significant impacts to surface water quality and drainage channel maintenance.

**Mitigation of Erosion and Sedimentation.** An erosion and sediment control plan for the entire Proposed Project would be developed by BART and submitted to the ACPWA and FPWD for review. The plan would comply with requirements of the Alameda County Grading Ordinance<sup>1</sup> and the NPDES non-point-source reduction programs, as a minimum.

Earthwork should primarily be scheduled outside the rainy season between October and April to minimize the potential of erosion of construction areas. If construction were to occur during the rainy season, the erosion and sediment control plan should specifically address measures to be undertaken during the rainy season. Bare ground on cut or fill slopes should be planted with vegetative cover designed to reduce erosion. Vegetation should be established by mid-September. The erosion and sediment control plan should identify the location and design of sediment retention structures. Sediment traps should be placed at the drainage outlet of each earthwork construction area but should not be constructed in existing drainage channels. Drainage outlets from sediment traps should be protected with energy dissipation techniques, such as rip-rap, to reduce erosion potential. Sediment barriers should be placed along the toe of the embankment over south Tule Pond to prevent sedimentation of the seasonal wetlands.

Erosion control structures should be inspected prior to the beginning of the rainy season and after major rainstorms. Problems identified by these inspections can then be remediated immediately.

**Modification of Hydrogeologic Conditions Related to Dewatering.** The construction of a subway through Central Park, as proposed by Design Option 1 and 2S, likely would require dewatering of saturated granular deposits above the bottom of the subway structures. It is possible, although less likely, that dewatering may also be necessary for the construction of the below-grade Irvington Station.

---

<sup>1</sup> Alameda County, 1984, Alameda County Grading Ordinance, Title 7, Ordinance 82-17.

Localized pumping of groundwater along the subway alignment would cause groundwater flow toward the subway excavation, lowering groundwater levels and changing groundwater flow direction. These effects could impact the operation of groundwater supply facilities in the area, including domestic wells and the ACWD Peralta Well Field. The significance of these hydrogeologic changes away from the construction area is dependent on the amount of groundwater table drawdown, the transmissivity of the water-bearing sediments, rates and duration of pumping during dewatering, and the distance to a potentially affected water supply facility. It is possible, but unlikely, that dewatering would result in a significant impact to groundwater supply facilities in the Fremont area.

If extensive groundwater dewatering is needed, it is possible that groundwater conditions over a wide area would be affected. Potential changes in groundwater flow direction could impact the rate and direction of migration of contaminated groundwater. These changes could result in accelerated migration or interference with remediation efforts at contaminated sites, which would be a significant impact. Most of the identified sites of releases of contaminants to the subsurface are over 2,000 feet from the proposed subway alignment (see Figure 3.3-1). Excessive pumping would be needed to affect this large area. Several sites at which contaminated groundwater has been identified are located in the area of the proposed Irvington Station. If dewatering is necessary in this area, the flow of groundwater could be significantly altered. In this situation, it is possible that contaminated groundwater may be drawn into the dewatered area. The potential movement of groundwater into the project area is a significant impact.

**Mitigation of Dewatering Impacts.** Prior to final design of a subway (Design Options 1 and 2S), an aquifer pump test should be conducted to better define the potential effects of dewatering on other groundwater supply facilities. The results of the pump test would be used to develop a dewatering strategy which would result in insignificant impacts to other groundwater users in the area. The dewatering plan should be submitted to the ACWD for review and approval. The dewatering plan should include provisions for the management of pumped water. Reuse of the water in the ACWD groundwater recharge program should be considered if the extracted volumes were of adequate quality. The volume and duration of groundwater extraction necessary for construction of the subway could be reduced by construction of groundwater barriers, such as slurry walls or sheet piles, to minimize groundwater flow into the construction area. The reduction in pumping would reduce the potential for groundwater level lowering and changes in groundwater flow direction outside the construction

area. Reduction of necessary groundwater extraction and appropriate design and monitoring of a dewatering program would reduce the impacts to an insignificant level.

**Temporary Reduction of Flood Water Storage.** Design Option 1 would require subway construction under the northeast arm of Lake Elizabeth. If the subway was constructed as a cut-and-cover structure, construction of a coffer dam would be necessary to prevent flooding of the excavation. Construction of an aerial structure across Lake Elizabeth could also require temporary disruption in Lake Elizabeth. Placement of the coffer dam across the lake would temporarily remove a volume of potential flood water storage (approximately 240,000 cubic feet if constructed as one segment). The same volume would be pumped from the interior of the coffer dam during construction and would need to be stored in other areas of the lake. The coffer dam location could block flow from drainage lines M and L into the lake if constructed as a continuous segment across the lake. The result of the blockage could be flooding upstream of the dam location which would be a significant impact.

**Mitigation of Temporary Reduction of Flood Water Storage.** The potential loss of flood water storage and resultant flooding would be mitigated by phased construction within summer months when flood waters would not be expected. Alternatively, the construction contractor would stage the work so that existing flows and storage capacities would be maintained. Either measure would reduce the potential for flooding, due to reduced flood water storage, to an insignificant level.

#### 3.4.3 IMPACTS OF ALTERNATIVES 1, 2, AND 3

##### **Direct Impacts**

Alternatives 1, 2, and 3 do not involve construction of the BART Warm Springs Extension Project and would not be impacted by or cause any of the specific direct hydrologic impacts identified for the Proposed Project. The highway construction and improvement projects proposed for alternatives 2 and 3 may contribute to localized flooding problems. Some of the Proposed Projects may be located within 100-year flood zones, particularly those projects within the San Francisco Bay Plain.

### **Cumulative Impacts**

Urban development within the southern portion of the East Bay region, including the area of the Proposed Project, likely would continue in the "no-build" alternatives. Increases in urban development would include increased construction of impervious cover and resultant increases in stormwater runoff. The increase in stormwater runoff could cause flooding and increased pollutant loading of surface water. The potential flooding problems could be mitigated to an insignificant level by improvements to the existing drainage systems of the region. The potential increase in contaminant loading could be mitigated to an insignificant level by appropriate management practices and stricter requirements for the control of non-point source discharges of hazardous materials.

### **Construction Impacts**

No construction impacts would be associated with Alternative 1. Alternatives 2 and 3 would involve new construction and improvements to roadway systems. The potential for increased erosion and sedimentation would be associated with these construction projects.

#### **3.4.4 IMPACTS OF ALTERNATIVE 4: A 5.4-Mile BART Extension with Two Stations**

##### **Direct Impacts**

The hydrologic impacts for Alternative 4 would be similar to those identified with the Proposed Project (all design options) from the existing Fremont BART station to the proposed Warm Springs Station. These impacts include stormwater storage loss in south Tule Pond, construction of structures within flood zones near Lake Elizabeth, potential hydrologic effects related to subway construction, and adverse foundation conditions associated with poor drainage or high groundwater levels. Mitigation measures for these impacts would be similar to those recommended for the Proposed Project.

Alternative 4 would not include construction of a South Warm Springs Station, reducing the amount of increased urban runoff relative to the Proposed Project. Elimination of the south Warm Springs Station would also reduce the potential loss of stormwater storage associated with construction of the station and parking facility. This impact would be reduced to an insignificant level by improvements to drainage line culverts crossing the project alignment.

### **Cumulative Impacts**

Alternative 4 has the same cumulative impacts, from the existing Fremont BART station to the proposed Warm Springs Station, as those identified for the Proposed Project. Increased urban development in the area will increase the stormwater runoff and contribute to flood problems if not mitigated. The mitigation measures described for the Proposed Project to the proposed Warm Springs Station apply to Alternative 4.

### **Construction Impacts**

Construction impacts related to subway construction dewatering and the mitigation measures identified for the Proposed Project would apply to the construction of Alternative 4. An additional location of potential for erosion and sedimentation is presented by the proposed construction of a fill embankment over Grimmer Boulevard for Alternative 4. The erosion and sediment control plan recommended for the Proposed Project would mitigate this potential impact to an insignificant level.

#### **3.4.5 IMPACTS OF ALTERNATIVE 5: A 5.4-Mile BART Extension with Two Stations**

The direct, cumulative, and construction hydrologic impacts for Alternative 5 would be similar to those described for Alternative 4. This alternative differs from Alternative 4 in that the crossing of Grimmer Boulevard would be on an aerial structure as in the Proposed Project. Potential erosion and sedimentation impacts under Alternative 5 would be reduced relative to that associated with construction of the fill embankment proposed in Alternative 4.

#### **3.4.6 IMPACTS OF ALTERNATIVE 6: A 7.8-Mile BART Extension with Two Stations (No Irvington Station)**

##### **Direct Impacts**

The direct impacts of Alternative 6 would be similar to those described for the Proposed Project. However, Alternative 6 would not include the construction of the Irvington Station, and would not result in an increased area of impervious cover. The amount of increased urban runoff and related potential for increased pollutant loading would be reduced relative to the Proposed Project.

### **Cumulative Impacts**

The cumulative impacts of Alternative 6, and its mitigation, would be similar to that identified for the Proposed Project.

### **Construction Impacts**

The erosion and sedimentation potential related to the construction of the cut slopes for the below-grade Irvington station would not be associated with alternative 6. All other construction impacts identified for the Proposed Project pertain to Alternative 6.

### **3.4.7 IMPACTS OF ALTERNATIVE 7: A 7.8-Mile BART Extension with Two Stations (No Irvington Station)**

#### **Direct Impacts**

From the Fremont Station to north of Washington Boulevard, the impacts of Alternative 7 would be the same as the Proposed Project. Alternative 7 differs from the Proposed Project in that the Irvington Station would not be constructed, and the exclusion of the station and parking area would reduce the impact of increased urban runoff reduced relative to the Proposed Project. Additionally, Alternative 7 includes an aerial crossing of Washington Boulevard; this would not result in a significant hydrological impact.

#### **Cumulative Impacts**

The cumulative hydrologic impacts are similar to those described for the Proposed Project, except for the exclusion of impacts related to the Irvington Station.

#### **Construction Impacts**

From the Fremont Station to north of Washington Boulevard, Alternative 7 would present the same impacts identified for construction as the Proposed Project. The potential impacts include effects on groundwater conditions caused by dewatering, temporary loss of flood water storage, and the potential erosion and sedimentation impacts related to excavation of the subway. The impacts associated with the construction of the Irvington Station would not occur under this alternative.

### **3.4.8 IMPACTS OF ALTERNATIVE 8: A 7.8-Mile BART Extension along Osgood Road and Warm Springs Boulevard with Two Stations (No Irvington Station)**

#### **Direct Impacts**

As with Alternatives 6, 7, 9 and 10, the Irvington Station would not be constructed. As in Alternative 7, an aerial section would cross Washington Boulevard. The impacts of construction of a subway on groundwater conditions would be similar to those described for the Proposed Project.

Unlike the other project alternatives, Alternative 8 proposes an aerial alignment over and in the center of Osgood Road and Warm Springs Boulevard from Washington Boulevard to the proposed South Warm Springs Station. Alternative 8 would generally reduce the amount of excavation and construction of impervious trackbed segments associated with the Proposed Project and other alternatives which involve construction of fill structures and transition segments over major roads south of the proposed Irvington Station location. The aerial span would not generate a significant increase in the runoff generated by the roadway pavements below. The Warm Springs and South Warm Springs Stations proposed in Alternative 8 would contribute similar increases in stormwater runoff as the same stations in the Proposed Project. As in the Proposed Project, construction of the South Warm Springs Station parking area could decrease the stormwater storage in the area if constructed above existing ground surface elevations.

#### **Cumulative Impacts**

The cumulative impact of continued urban development within the watersheds crossed by the Alternative 8 alignment would be increased by stormwater runoff and potential for flooding. The mitigation of these cumulative impacts is described for similar impacts related to the Proposed Project.

#### **Construction Impacts**

Hydrologic impacts associated with the implementation of Alternative 8 would be similar to those described for Alternative 7.

**3.4.9 IMPACTS OF ALTERNATIVE 9: A 5.4-Mile BART Extension with One Station (Warm Springs)**

**Direct Impacts**

The direct hydrologic impacts related to Alternative 9 are similar to those identified for the alignment segment of Alternative 6 north of the Warm Springs Station. Both alternatives would not involve the impacts associated with construction of the Irvington Station. Implementation of Alternative 9 would result in increased urban runoff from the Warm Springs Station area.

**Cumulative Impacts**

The cumulative hydrologic impacts associated with Alternative 9 are similar to those described for Alternatives 4 and 5. Increased development in the Irvington area would not be stimulated by the construction of the Irvington Station, slightly reducing the cumulative impact on stormwater runoff relative to Alternatives 4 and 5.

**Construction Impacts**

The impacts from and to the hydrologic conditions related to Alternative 9 would be similar to those described for a portion of alignment in Alternative 6, north of the Warm Springs Station. Alternative 9 would have none of the construction impacts associated with construction of the Irvington Station.

**3.4.10 IMPACTS OF ALTERNATIVE 10: A 7.8-Mile BART Extension with One Station (South Warm Springs)**

**Direct Impacts**

The Alternative 10 alignment follows the same route as the Proposed Project with the exception that the Irvington and Warm Springs stations would not be constructed. The direct hydrologic impacts for Alternative 10 would be similar to Alternative 6.

Alternative 10 is unique in that it is a 7.8-mile alignment with a single station (South Warm Springs) at the southern terminus. In excluding the Irvington and Warm Springs stations, Alternative 10 significantly reduces the area of constructed impervious surface associated with



the Proposed Project. As with the Proposed Project, the construction of the South Warm Springs Station could result in loss of stormwater storage.

### **Cumulative Impacts**

The cumulative impacts for Alternative 10 are similar to those described for the Proposed Project, except that elimination of the Irvington and Warm Springs stations may result in less development in those areas relative to the Proposed Project, but development is still expected with or without the station.

### **Construction Impacts**

The impacts of construction of Alternative 10 on existing hydrologic conditions would be similar to those described for Alternative 6. The potential erosion and sedimentation impacts during construction of the fill embankment and subway would be similar to the Proposed Project and Alternative 6. Exclusion of the Irvington Station would reduce the potential for erosion and sedimentation relative to the Proposed Project. Grading associated with construction of the Warm Springs Station would slightly reduce the erosion impact relative to Alternative 6.

### **3.4.11 IMPACTS OF ALTERNATIVE 11: A 7.8-Mile BART Extension with Two Stations (Irvington and South Warm Springs)**

#### **Direct Impacts**

The Alternative 11 alignment is similar to the Proposed Project with the exception that the Warm Springs Station is not included in the alternative. The direct impacts of this alternative would be similar to the Proposed Project. The elimination of the Warm Springs Station would reduce the area of constructed impervious surface relative to the Proposed Project.

#### **Cumulative Impacts**

The implementation of Alternative 11 would result in similar cumulative impacts to those anticipated for the Proposed Project. In Alternative 11, the elimination of the Warm Springs Station may result in reduced development relative to the Proposed Project. However, urban development is likely to occur in the Warm Springs Station area with or without implementation of a BART extension. Construction of impervious surfaces, increased runoff, and potential

degradation of surface water quality are potential cumulative effects of urban development within the South Bay area.

**Construction Impacts**

The construction impacts on water resources related to implementation of Alternative 11 are similar to those described for the Proposed Project. Elimination of the Warm Springs Station would cause a reduction in the amount of grading relative to the Proposed Project, reducing the potential for increased erosion and sedimentation.

## 3.5 ECOSYSTEMS

### 3.5.1 SETTING AND EXISTING CONDITIONS

#### Introduction

The Proposed Project and build alternatives pass through ruderal forb-grasslands and agricultural fields, open water habitats, forested and emergent seasonal wetlands, and urban and residential landscaped areas (Figure 3.5-1). Plant and animal resources in each habitat in the project area are discussed below including the potential for rare, threatened, or endangered species, and species of special concern.

Existing conditions were assessed using available information and field surveys. Background information on the biological resources of the project corridor was obtained from the May 1990 BART Warm Springs Extension Draft Environmental Impact Report.<sup>1</sup> Records of sensitive plant and animal species in the area were obtained from the California Department of Fish and Games's Natural Diversity Data Base and confirmed with on-site surveys.<sup>2</sup> On-site surveys were carried out during March and April 1991 to determine wildlife habitat use within the project area. Several individuals with personal knowledge of the biological resources within the project corridor were contacted to determine current and historical information. Such contacts include Dr. Howard Cogswell (Professor Emeritus, California State University, Hayward), Alice Hoch (Ohlone Audubon Society), and City of Fremont Environmental Services staff.

#### Urban and Residential Landscaped Areas

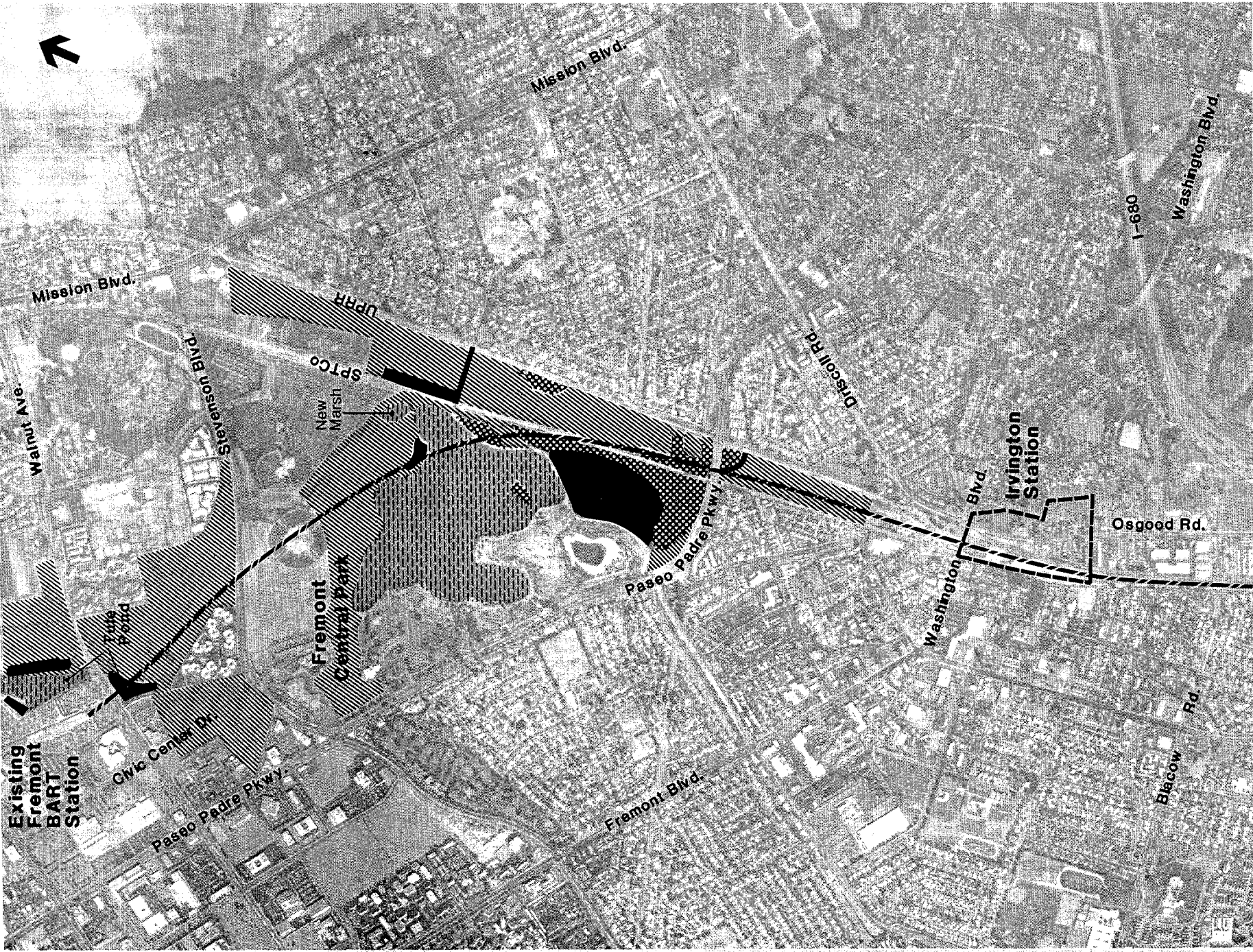
**Vegetation.** Landscaped areas are found in Fremont Central Park and in residential and commercial development throughout the 7.8-mile project corridor. Typical vegetation of these landscaped areas include lawns with native and exotic trees such as redwood (*Sequoia sempervirens*), sycamore (*Platanus racemosa*), pine (*Pinus* sp.), eucalyptus (*Eucalyptus* sp.), and sweetgum (*Liquidamber styraciflua*).<sup>3</sup>

---

<sup>1</sup> EIP Associates, "Ecosystems," Draft Environmental Impact Report for BART Warm Springs Extension, May 1990.

<sup>2</sup> California Department of Fish and Game, Natural Diversity Data Base System for Milpitas and Niles Quadrangles, July 1990.

<sup>3</sup> EIP Associates.

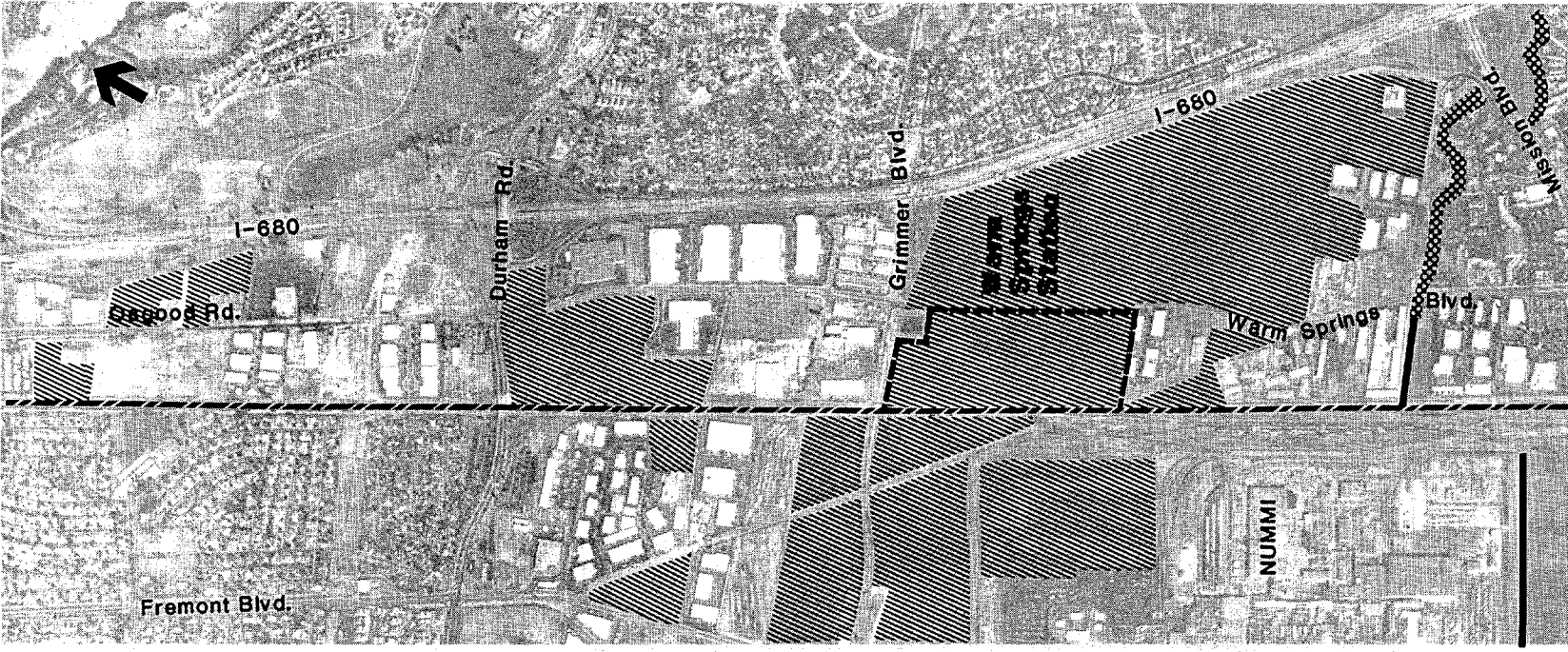


SOURCE: Wetlands Research Associates, 1991

NOT TO SCALE

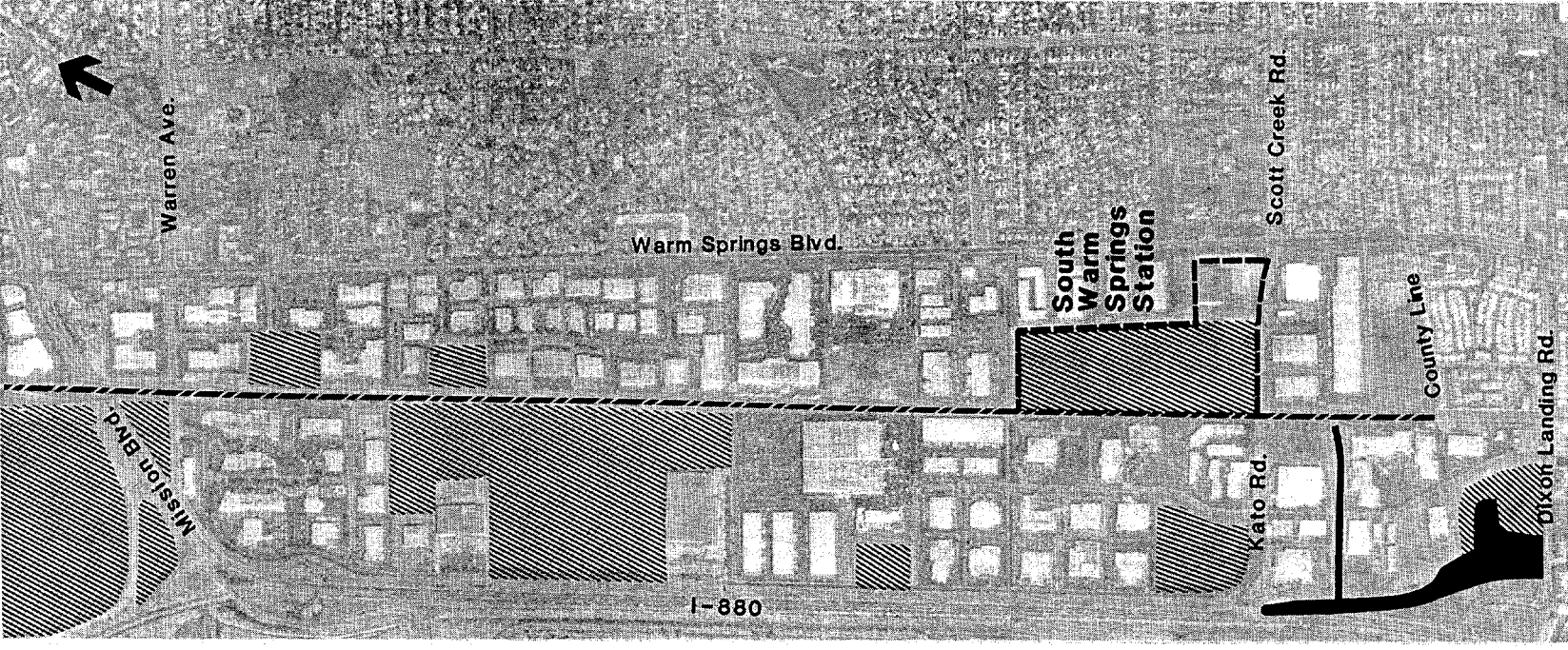
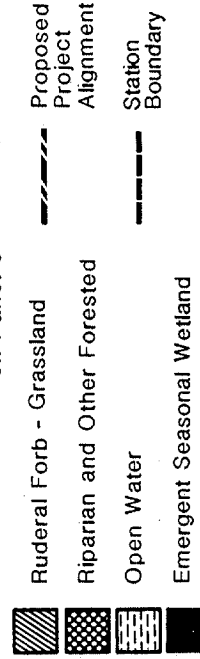
Continued on Panel 2

PANEL 1



Continued on Panel 3

PANEL 2



PANEL 3

Figure 3.5-1  
CORRIDOR HABITAT

**Wildlife.** Table 3.5-1 lists common birds and mammals that have been observed or would be expected to use the urban and residential landscaped areas within the project corridor. Data were collected in surveys during March-April 1991 by Wetland Research Associates, surveys for the May 1990 BART Warm Springs Extension DEIR, and occasional surveys over a several year period.<sup>1</sup>

#### **Ruderal Forb-Grassland and Agricultural Fields**

**Vegetation.** Ruderal forb-grassland and agricultural fields occupy most of the undeveloped land along the proposed BART extension alignment south of Paseo Padre Parkway and north of Central Park. Vegetation typical of these disturbed areas includes early flowering annuals, mainly mustard and introduced grasses. Dominant vegetation includes black mustard (*Brassica nigra*), field mustard (*B. campestris*), wild barley (*Hordeum leporinum*), rip-gut grass (*Bromus diandrus*), and slender wild oat (*Avena barbata*). Subdominant vegetation includes Italian ryegrass (*Lolium perenne*), fiddleneck (*Amsinckia* sp.) and clasping henbit (*Lamium amplexicaule*).

**Wildlife.** Table 3.5-1 lists common birds and mammals that have been observed or would be expected to use the ruderal forb-grassland and agricultural fields within the project corridor. Ruderal and agricultural areas along the alignments provide foraging and nesting habitat to a wide variety of animals. An active fox den was located in the field between Walnut Avenue and Stevenson Boulevard directly south of the Fremont BART Station and in line with the proposed extension. Both red and grey foxes use the park area and may be occupying this den.<sup>2</sup>

- **Raptors.** Both hawks and owls are known to use the project area. Red-tailed hawks nest in the large eucalyptus trees adjacent to the Fremont BART station.<sup>3</sup> Northern harriers, Cooper's hawks, and black-shouldered kites, listed by the California Department of Fish and Game as Species of Special Concern, use these open grasslands and have been observed in the project area.<sup>4</sup>

---

<sup>1</sup> Ohlone Audubon Society, Alice Hoch, personal communication (3/29/91 and 4/2/91), and unpublished bird list.

<sup>2</sup> City of Fremont Environmental Services Staff, Laurie Scaling and Judy Felber, personal communication (3/28/91, 4/2/91 and 4/8/91).

<sup>3</sup> Ohlone Audubon Society.

<sup>4</sup> Ohlone Audubon Society.

**Table 3.5-1  
Birds and Mammals Observed or Expected to Use Habitat  
Along Proposed Project Alignment**

Common ( <i>Scientific</i> ) name	Habitats <sup>1</sup>				
	UR	GA	LE	RF	SW
<i>Birds</i>					
Double-crested Cormorant ( <i>Phalacrocorax auritus</i> )			☐		
Pied-billed Grebe ( <i>Podilymbus podiceps</i> )			☐		
Western Grebe ( <i>Aechmophorus occidentalis</i> )			☐		
Great Blue Heron ( <i>Ardea herodias</i> )			☐		☐
Green-backed Heron ( <i>Butorides striatus</i> )			☐		☐
Great Egret ( <i>Casmerodius albus</i> )		☐	☐		☐
Snowy Egret ( <i>Egretta thula</i> )			☐		
Black-crowned Night Heron ( <i>Nycticorax nycticorax</i> )			☐		
Canada Goose ( <i>Branta canadensis</i> )			☐		
Greater White-fronted Geese ( <i>Anser albifrons</i> )			☐		
Cinnamon Teal ( <i>Anas cyanoptera</i> )			☐		
Bufflehead ( <i>Bucephala albeola</i> )			☐		
Mallard ( <i>Anas platyrhynchos</i> )			☐		☐
Ruddy Duck ( <i>Oxyura jamaicensis</i> )			☐		
Turkey Vulture ( <i>Cathartes aura</i> )		☐			
Black-shouldered Kite ( <i>Elanus caeruleus</i> )+		☐			
Northern Harrier ( <i>Circus cyaneus</i> )+		☐			
Sharp-shinned Hawk ( <i>Accipiter striatus</i> )		☐			

<sup>1</sup> UR = Urban and residential landscaped; GA = Grassland and agriculture; LE = Lake Elizabeth; RF = Riparian forest; SW = Seasonal wetlands.

**Key:**

- + = Species of special concern.
- \* = Candidate for listing under Federal Endangered Species Act.
- ☐ = Species observed in habitat.
- = Species expected in habitat.

Table 3.5-1 (Continued)

Common ( <i>Scientific</i> ) name	Habitats <sup>1</sup>				
	UR	GA	LE	RF	SW
Cooper's Hawk ( <i>Accipter cooperii</i> )+		☐		☐	
Red-shouldered Hawk ( <i>Buteo lineatus</i> )		☐		☐	
Red-tailed Hawk ( <i>Buteo jamaicensis</i> )		☐			
Ferruginos Hawk ( <i>Buteo regalis</i> )		☐			
American Kestrel ( <i>Falco sparverius</i> )		☐			
Ring-necked Pheasant ( <i>Phasianus colchicus</i> )		☐			
Virginia Rail ( <i>Rallus limicola</i> )			☐		
American Coot ( <i>Fulica americana</i> )			☐		☐
Common Moorhen ( <i>Gallinula chloropus</i> )			☐		☐
Sora ( <i>Porzana carolina</i> )			☐		☐
Killdeer ( <i>Charadrius vociferus</i> )					☐
Black-necked Stilt ( <i>Himantopus mexicanus</i> )					☐
Greater Yellowlegs ( <i>Tringa melanoleuca</i> )					☐
Least Sandpiper ( <i>Calidris minutilla</i> )			☐		☐
Short-billed Dowitcher ( <i>Limnodromus griseus</i> )			☐		☐
Long-billed Dowitcher ( <i>Limnodromus scolopaceus</i> )			☐		☐
Common Snipe ( <i>Gallinago gallinago</i> )		☐			☐
Long-billed Curlew ( <i>Numenius phaeopus</i> )*		☐			
Western Gull ( <i>Larus occidentalis</i> )			○		
Rock Dove ( <i>Columba livia</i> )	☐				
Mourning Dove ( <i>Zenaida macroura</i> )	☐	☐	☐		
Burrowing Owl ( <i>Athene cunicularia</i> )+		☐			
White-throated Swift ( <i>Aeronautes saxatalis</i> )		☐	☐	☐	☐

<sup>1</sup> UR = Urban and residential landscaped; GA = Grassland and agriculture; LE = Lake Elizabeth; RF = Riparian forest; SW = Seasonal wetlands.

Key:

- + = Species of special concern.
- \* = Candidate for listing under Federal Endangered Species Act.
- ☐ = Species observed in habitat.
- = Species expected in habitat.

Table 3.5-1 (Continued)

Common ( <i>Scientific</i> ) name	Habitats <sup>1</sup>				
	UR	GA	LE	RF	SW
Anna's Hummingbird ( <i>Calypte anna</i> )		☐		☐	
Nuttall's Woodpecker ( <i>Dendrocopos nuttallii</i> )				☐	
Downy Woodpecker ( <i>Dendrocopos pubescens</i> )				☐	
Northern Flicker ( <i>Colaptes auratus</i> )				☐	
Black Phoebe ( <i>Sayornis nigricans</i> )		☐		☐	
Say's Phoebe ( <i>Sayornis saya</i> )		☐		☐	
Tree Swallow ( <i>Tachycineta bicolor</i> )		☐		☐	
Violet-green Swallow ( <i>Tachycineta thalassina</i> )		☐	☐		
Northern Rough-winged Swallow ( <i>Stelgidopteryx serripennis</i> )			☐	☐	
Cliff Swallow ( <i>Hirundo pyrrhonota</i> )		☐	☐		
Barn Swallow ( <i>Hirundo rustica</i> )		☐	☐		
Common Crow ( <i>Corvus brachyrinchos</i> )		☐		☐	
Scrub Jay ( <i>Aphelocoma coerulescens</i> )	☐			☐	
Bushtit ( <i>Psaltriparus minimus</i> )				☐	
Marsh Wren ( <i>Cistothorus palustris</i> )			☐		
Swainson's Thrush ( <i>Catharus ustulatus</i> )				☐	☐
Northern Mockingbird ( <i>Mimus polyglottos</i> )	☐			☐	
American Robin ( <i>Turdus migratorius</i> )	☐	☐			
Northern Shrike ( <i>Lanius excubitor</i> )		☐		☐	
European Starling ( <i>Sturnus vulgaris</i> )	☐	☐			
Yellow Warbler ( <i>Dendroica petechia</i> )			☐	☐	
Yellow-rumped Warbler ( <i>Dendroica coronata</i> )				☐	
Common Yellowthroat ( <i>Geothlypis trichas</i> )			☐	☐	

<sup>1</sup> UR = Urban and residential landscaped; GA = Grassland and agriculture; LE = Lake Elizabeth; RF = Riparian forest; SW = Seasonal wetlands.

Key:

- + = Species of special concern.
- \* = Candidate for listing under Federal Endangered Species Act.
- ☐ = Species observed in habitat.
- = Species expected in habitat.



Table 3.5-1 (Continued)

Common ( <i>Scientific</i> ) name	Habitats <sup>1</sup>				
	UR	GA	LE	RF	SW
Wilson's Warbler ( <i>Wilsonia pusilla</i> )				☐	
Lazuli Bunting ( <i>Passerina amoena</i> )			☐	☐	
California Towhee ( <i>Pipilo crissalis</i> )	☐	☐		☐	
Rufous-sided Towhee ( <i>Pipilo erythrophthalmus</i> )				☐	
Savannah Sparrow ( <i>Passerculus sandwichensis</i> )		☐	☐		☐
Song Sparrow ( <i>Melospiza melodia</i> )				☐	
Lincoln's Sparrow ( <i>Melospiza lincolni</i> )			☐	☐	
Golden-crowned Sparrow ( <i>Zonotrichia atricapilla</i> )		☐		☐	
White-crowned Sparrow ( <i>Zonotrichia leucophrys</i> )		☐			
Red-winged Blackbird ( <i>Agelaius phoeniceus</i> )			☐		☐
Tricolored Blackbird ( <i>Agelaius tricolor</i> )*			○		○
Western Meadowlark ( <i>Sturnella neglecta</i> )		☐			
Brewer's Blackbird ( <i>Euphagus cyanocephalus</i> )	☐	☐			
House Finch ( <i>Carpodacus mexicanus</i> )				☐	
Lesser Goldfinch ( <i>Carduelis psaltria</i> )		☐	☐	☐	
American Goldfinch ( <i>Carduelis tristis</i> )		☐		☐	
<b>Mammals</b>					
Red Fox ( <i>Vulpes fulva</i> )		☐		☐	
Gray Fox ( <i>Urocyon cinereoargenteus</i> )		☐		☐	
Black-tailed Jackrabbit ( <i>Lepus californicus</i> )		☐			
Meadow Vole ( <i>Microtus californicus</i> )		○			

<sup>1</sup> UR = Urban and residential landscaped; GA = Grassland and agriculture; LE = Lake Elizabeth; RF = Riparian forest; SW = Seasonal wetlands.

Key:

- + = Species of special concern.
- \* = Candidate for listing under Federal Endangered Species Act.
- ☐ = Species observed in habitat.
- = Species expected in habitat.

Table 3.5-1 (Continued)

Common ( <i>Scientific</i> ) name	Habitats <sup>1</sup>				
	UR	GA	LE	RF	SW
Deer Mouse ( <i>Peromyscus maniculatus</i> )		○			
Western Harvest Mouse ( <i>Reithrodontomys megalotis</i> )		○			
California Ground Squirrel ( <i>Otospermophilus beecheyi</i> )		◻			
Bottae Pocket Gopher ( <i>Thomomys bottae</i> )		◻			
Virginia Opossum ( <i>Didelphis virginiana</i> )				○	
Striped Skunk ( <i>Mephitis mephitis</i> )				○	
Muskrat ( <i>Ondatra zibethius</i> )			◻		
Raccoon ( <i>Procyon lotor</i> )				○	

<sup>1</sup> UR = Urban and residential landscaped; GA = Grassland and agriculture; LE = Lake Elizabeth; RF = Riparian forest; SW = Seasonal wetlands.

Key:

+ = Species of special concern.

\* = Candidate for listing under Federal Endangered Species Act.

◻ = Species observed in habitat.

○ = Species expected in habitat.

Burrowing owls, listed by the California Department of Fish and Game as a Species of Special Concern, use ruderal grasslands and agricultural areas. Burrowing owls were observed in 1990 and 1991 in the project area; the owls have bred and fledged young in the project area in past years.<sup>1</sup> Burrowing owls use tunnels excavated by other animals, primarily those of ground squirrels.<sup>2</sup> Because ground squirrels are common in ruderal grassland, other burrowing owl occurrences may be expected.

Additional discussion of northern harriers, Cooper's hawks, black-shouldered kites, and burrowing owls is given in the "Species of Special Concern" section below.

- **Waterbirds.** Temporarily flooded grassland areas provide foraging areas for waterfowl and shorebirds. Mallards, American coots, long-billed dowitchers, and black-necked stilts were observed foraging in temporarily flooded grassland in March 1991. Twenty-one long billed curlew, a Category 2 Species of Special Concern as listed by the U.S. Fish and Wildlife Service, were observed in the ruderal-forb-grassland just south of Stevenson Boulevard in Central Park in March 1991. This type of habitat may also provide foraging areas for these water birds during fall migration and winter.<sup>3</sup>

#### Open Water Habitats

**Vegetation.** Lake Elizabeth, in Fremont Central Park, is a man-made lake (approximately 83 acres) that replaced a naturally occurring sag pond (known as Stiver's Lagoon) and fresh water marsh. The lake has a concrete and riprap shoreline, creating a limited area for bank vegetation. A narrow band of cattails (*Typha latifolia*) and hardstem bulrush (*Scirpus acutus*) grow among the riprap along a portion of the shoreline. An island in the southern portion of the lake has a dense arroyo willow (*Salix lasiolepis*) cover.

A small pond (New Marsh) at the north end of Lake Elizabeth was constructed approximately five years ago and serves as a retention basin for park runoff. The upper banks of the pond do not support vegetation and only the pond edge supports patches of hardstem bulrush and cattails.

---

<sup>1</sup> City of Fremont staff and Wetland Research Associates.

<sup>2</sup> Thompson, L. "Behavior and ecology of burrowing owls in the Oakland Municipal Airport," 1971. *Condor* 73:177-192.

<sup>3</sup> Wetland Research Associates.

### 3.5 Ecosystems

Tule Pond (also known as Tyson's Lagoon), located north of Walnut Avenue and east of the Fremont BART Station, is on the site of a sag pond, similar to Lake Elizabeth, and is approximately 6 acres (Figure 3.5-1). The northern portion of Tule Pond remains flooded year-round and serves as a flood control basin for local urban runoff. Emergent vegetation in shallow portions of the pond includes hardstem bulrush, cattails, knotweed (*Polygonum lapathifolium*), and flat sedge (*Cyperus eragrostis*). Peripheral upland vegetation includes ripgut grass, black mustard, and coyote brush (*Baccharis pilularis*). Vegetation of the southern portion of Tule Pond, south of Walnut Avenue, is discussed in the following section on seasonal wetlands.

A number of historic creeks, which once meandered from the Diablo Range east of the project area to the bay, are now channelized flood control ditches. Most of these have been fenced and lined with concrete. There are, however, a few exceptions. Mission Creek east of Lake Elizabeth and the flood control channel just north of Paseo Padre Parkway have been channelized, but not lined with concrete. Flooded portions of the creeks typically support cattails, watercress (*Nasturtium officinale*), hardstem bulrush, knotweed, and alkali bulrush (*Scirpus robustus*). These are periodically removed for flood control purposes. Bank vegetation includes salt grass (*Distichlis spicata*), rabbitfoot grass (*Polypogon monspeliensis*), and cocklebur (*Xanthium strumarium*). The flood control channel south of Warren Avenue is concrete lined and fenced west of Osgood Road. However, to the east the channel has not been lined and supports cattail in the channel bed and arroyo willow along its banks.

**Wildlife.** Table 3.5-1 lists common birds and mammals that have been observed or would be expected to use the open water habitats within the project corridor. Channel catfish (*Ictalurus punctatus*), black bass (*Micropterus salmoides*), crappie (*Pomoxis* spp.), carp (*Cyprinus carpio*), and occasional trout (*Oncorhynchus mykiss*) occur in Lake Elizabeth. Although stocking has occurred in the past, fish are not currently stocked in the lake.<sup>1</sup>

Birds that use the open waters of Lake Elizabeth and New Marsh are listed in Table 3.5-1 and include mallard, ruddy ducks and pied-billed and western grebes observed on Wetlands Research Associates' March 1991 survey of the area. Domesticated geese and a flock of resident Canadian geese also use the lake.

The shorelines of both Lake Elizabeth and New Marsh have only a few areas with emergent vegetation. Although limited, these provide habitat for birds including American coot, great

---

<sup>1</sup> City of Fremont Environmental Services staff.

egret, green-backed heron, great blue heron and red-winged blackbird observed during recent surveys. In addition, barn swallows, violet-green swallows, and northern rough-winged swallows were observed foraging over the emergent vegetation and open waters of the lake and adjacent grassland.<sup>1</sup>

Tule Pond (Tyson's Lagoon) to the north of Walnut Avenue has a perimeter of marsh vegetation and thus provides foraging, roosting, and nesting habitat for marsh birds and mammals. American coot, double-crested cormorant, great blue heron, mallard, pied-billed grebe, common moorhen, red-winged blackbird, and song sparrow have been observed using this pond.<sup>2</sup> Wildlife of the southern portion of Tule Pond, south of Walnut Avenue, is discussed in the following section on riparian forest and seasonal wetlands.

Most of the flood control channels that cross the project area are fenced and lined with concrete or riprap and, as a result, are of little value to wildlife. Ditches that are unlined and have emergent vegetation, however, are important to wildlife. For example, the Mission Creek flood control channel and undeveloped adjacent areas support a variety of wildlife including muskrat, fox and over 70 species of birds.<sup>3</sup>

Tricolored blackbirds, a Category 2 Species of Special Concern as listed by the US Fish and Wildlife Service, may use the emergent wetland vegetation and nearby grassland areas around Fremont Central Park. Over 100,000 nested in Stiver's Lagoon in 1966 before it was replaced by Lake Elizabeth.<sup>4</sup> In 1986 tricolored blackbirds nested near the southern end of the project alignment, at the junction of Interstates 880 and 680, in disturbed ruderal habitat.<sup>5</sup> Because all populations of tricolored blackbirds are nomadic and are opportunistic rather than site faithful during the breeding season, it is difficult to predict occupancy of specific sites, but their occurrence on the project site is possible.

The San Francisco forktail damselfly (*Ischnuara gemina*), a federal candidate species (Category 2), may occur in the flood control channels and other permanent water habitats, but has not been identified in the project corridor to date.

---

<sup>1</sup> Wetland Research Associates.

<sup>2</sup> EIP Associates.

<sup>3</sup> Ohlone Audubon Society.

<sup>4</sup> Dr. Howard Cogswell, personal communication (3/29/91).

<sup>5</sup> California Dept. of Fish and Game, Natural Diversity Data Base System.

### Forested and Emergent Seasonal Wetlands

**Vegetation.** Riparian forest is found east of Lake Elizabeth and extends to south of Paseo Padre Parkway. The dominant trees are willow with an understory of blackberry (*Rubus* spp.), poison oak (*Rhus diversiloba*), poison hemlock (*Conium maculatum*), stinging nettle (*Urtica dioica*), and rush (*Juncus* sp.).

Forested wetlands also occur as isolated stands of willows growing in shallow depressions that are seasonally flooded. Forested wetlands in the project area include sites adjacent to the UPRR south of Mission Creek and to the south and adjacent to Paseo Padre Parkway. Total forested area is approximately 22 acres.

Emergent, herbaceous seasonal wetlands are found between riparian forest and Lake Elizabeth and in small isolated pockets within the ruderal forb-grassland. Dominant vegetation in these wetlands include cattail, hardstem bulrush, ox tongue (*Picris echioides*), and rush. A shallow ditch meanders through this area and is bordered with willow, coyote brush, rip-gut grass, foxtail barley (*Hordeum leporinum*), and saltbush (*Atriplex patula*). Bottom and bank vegetation includes cattails and hardstem bulrush.

The portion of Tule Pond south of Walnut Avenue is not permanently flooded, but serves as a flood control basin during the wet season. Dominant plants in the seasonally flooded portion of the basin include knotweed, cattail, hardstem bulrush and arroyo willow. The surrounding undeveloped grassland has a cover of rip-gut grass and wild barley with coyote brush as the primary shrub cover.

Total emergent wetlands in the project corridor are approximately 49 acres.

**Wildlife.** Table 3.5-1 lists common birds and mammals that have been observed or would be expected to use the forested and emergent seasonal wetlands within the project corridor. The riparian forest to the east of Lake Elizabeth and extending south of Paseo Padre Parkway, although isolated, is an important remnant of a locally and nationally diminishing wildlife habitat. Most states, including California, have lost over 90 percent of their original riparian forest.<sup>1</sup> Common birds and mammals expected to be found in this habitat (Table 3.5-1) include opossum, raccoon, striped skunk, as well as yellow-rumped warbler, common yellowthroat, Wilson's

---

<sup>1</sup> U.S. Fish and Wildlife Service. *Riparian vegetation protection program: an appraisal level study, 1984*, Division of Ecological Services, Sacramento CA.

warbler, song sparrow, white-crowned sparrow, black phoebe, California towhee, rufous-sided towhee, scrub jay, bushtit, Nuttall's woodpecker, downy woodpecker, northern flicker and northern mockingbird.<sup>1</sup> The remnant riparian forest greatly increases the biological diversity in an area otherwise comprised of residential, agricultural, and wetland habitats and lacking forested and densely vegetated habitats. The riparian forest supports a wide variety of wildlife that are year-long residents. In addition, the forests provide essential cover, resting, and foraging areas for migratory birds that may be found here for only days or weeks at a time.

Species observed using unforested seasonal wetland south of Walnut Avenue and north of Stevenson Boulevard include pheasant, white-crowned sparrow and swainson thrush,<sup>2</sup> as well as mallard, mourning dove, yellow-rumped warbler, song sparrow, and California towhee.<sup>3</sup>

#### **Rare, Threatened, and Endangered Species and Species of Special Concern.**

No rare, threatened, or endangered species as defined in Section 3 of the Endangered Species Act (ESA) are known or expected to occur within the project corridor.<sup>4</sup> Candidate species that the U.S. Fish and Wildlife Service (USFWS) is considering for listing as threatened or endangered are divided into two categories. Category 1 candidates are species for which sufficient information exists to support listing, but which have yet to be proposed for listing. Category 2 candidates are species for which current information indicates that proposing to list them is appropriate, but for which substantial data on biological vulnerability are lacking. While candidate species have no protection under the ESA, some federal agencies accord higher level of management consideration to candidate than non-candidate species. One Category 2 species, the long-billed curlew, occurs on the project area. Another Category 2 species, the tricolored blackbird, has used the area in large numbers in the past and may occasionally be found there. A third, the San Francisco forktail damsel fly, may be present, but there are no reported incidences of occurrence.

The California Department of Fish and Game (CDFG) also lists threatened and endangered species, but none are known or expected to occur within the project corridor. The U.S. Fish and Wildlife Service, in correspondence on this project, suggest that bank swallows, listed by the CDFG as threatened, may exist in the project area; however, all surveys to date have not

---

<sup>1</sup> Wetland Research Associates.

<sup>2</sup> EIP Associates.

<sup>3</sup> Wetland Research Associates.

<sup>4</sup> California Dept. of Fish and Game, Natural Diversity Data Base System.

observed bank swallows in the project area.<sup>1,2,3,4</sup> In addition, the CDFG lists animal species of "Special Concern" whose California breeding populations, in most cases, may face extirpation.<sup>5</sup> The CDFG directs management activities towards determining their population status and threats to survival. The list is intended as a management tool, and these species should be taken into account whenever changes in land management are anticipated. Species of Special Concern that are known to use the project area are black-shouldered kites, northern harriers, Cooper's hawks, and burrowing owls.

**Vegetation.** No rare, threatened, or endangered or candidate plant species are known within the project corridor.<sup>6,7</sup> However, the USFWS has indicated that two Category 2 candidates for listing may be present.<sup>8</sup> These are Hoover's button-celery (*Eryngium aristulatum* var. *hooveri*) and delta tule-pea (*Lathyrus jepsonii* ssp. *jepsonii*).

**Wildlife.** Several federal candidate species and CDFG species of Special Concern occur within the project corridor (Table 3.5-1).

- **Long-billed curlew** (*Numenius americanus*). Twenty-one long-billed curlew, a Category 2 candidate species listed by the USFWS, were observed by Wetlands Research Associates in the ruderal grassland survey conducted during March 1991. The ruderal grassland and agricultural fields may provide foraging areas during migration and winter. The concerns for long-billed curlew populations are due to a continuing decline in numbers on their breeding areas, the dry prairies and meadows of western North America.
- **Tricolored blackbird** (*Agelaius tricolor*). Tricolored blackbirds are a Category 2 Candidate species listed by the USFWS. These birds are resident in California and occur most commonly in the Sacramento and San Joaquin Valleys. All populations are

---

<sup>1</sup> Wetland Research Associates.

<sup>2</sup> EIP Associates.

<sup>3</sup> California Department of Fish and Game, Natural Diversity Data Base System.

<sup>4</sup> Ohlone Audubon Society, Alice Hoak, unpublished bird list.

<sup>5</sup> California Department of Fish and Game. State and federal lists of endangered and threatened species, 1987. Resources Agency, Sacramento CA.

<sup>6</sup> EIP Associates.

<sup>7</sup> California Department of Fish and Game, Natural Diversity Data Base System.

<sup>8</sup> U.S. Fish and Wildlife Service letter to BART dated June 29, 1990.



### 3.5 Ecosystems

in some degree nomadic which makes year-to-year predictions of their occurrence in any specific area difficult. They occur in the San Francisco Bay Area mainly in winter. Their numbers are declining because of the draining of freshwater marshes, their primary habitat. Their occurrence in the project area was discussed previously in this section.

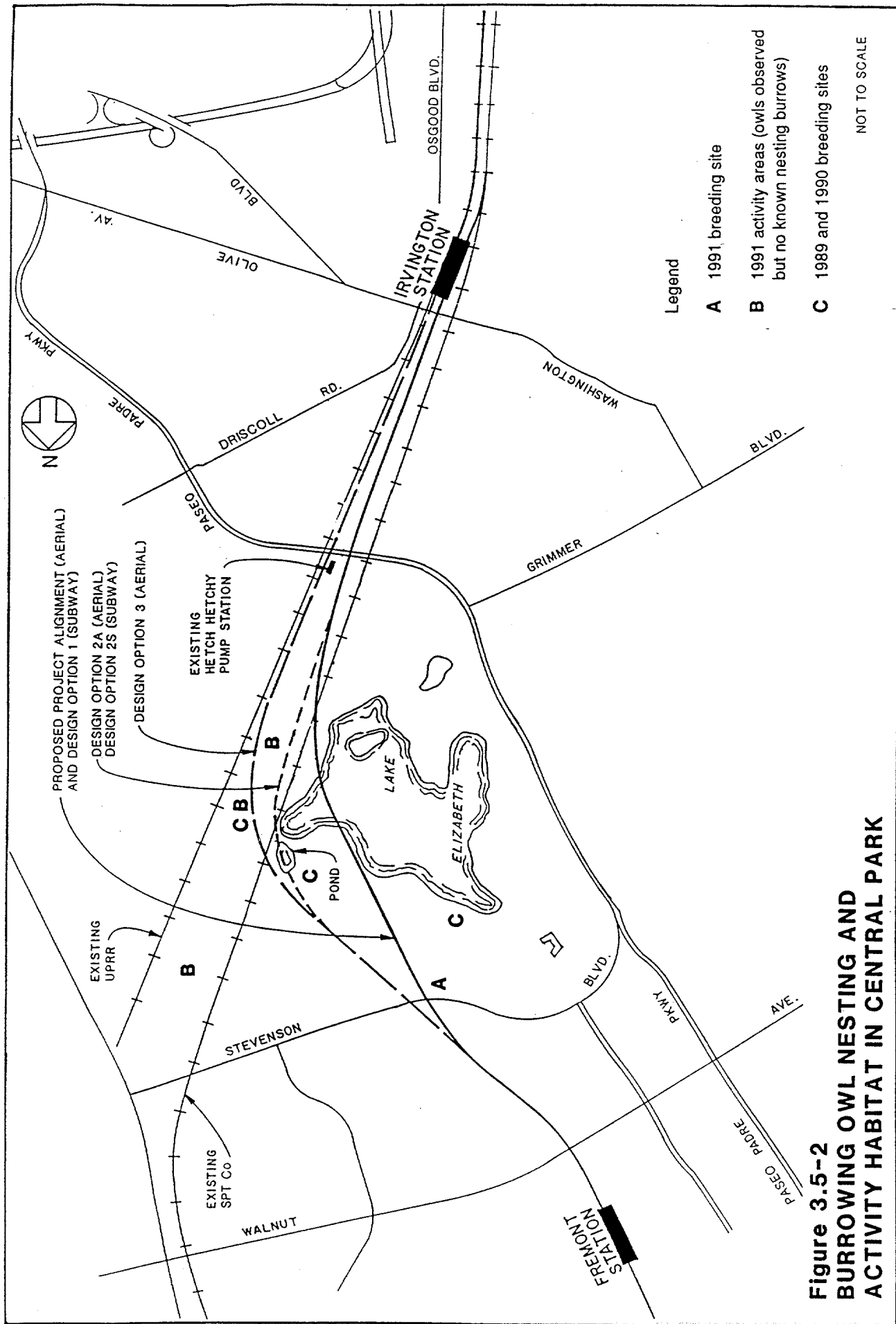
- **Northern Harrier (*Circus cyaneus*).** The northern harrier is listed by the CDFG as a Species of Special Concern. Northern harriers are found in marshes and grasslands throughout the year in California and have been observed foraging in the ruderal grasslands and agricultural fields in the project area. Since the destruction of marshes and grassland is one of the major reasons for decline, marsh habitat and upland nesting habitat should be preserved whenever possible.
- **Black-shouldered Kite (*Elanus caeruleus*).** The kite is listed by the CDFG as a Species of Special Concern. Black-shouldered kites require partially open habitat for foraging and trees for nesting and roosting. Ruderal grassland and agricultural fields provide foraging habitat in the project area, and kites have been observed in these areas.<sup>1</sup>
- **Cooper's Hawk (*Accipter cooperi*).** Cooper's hawks have declined throughout California as a breeding bird, primarily as a result of habitat destruction in lowland riparian areas, and the CDFG recommends protecting riparian areas throughout California. Cooper's hawks have been observed foraging in the ruderal grassland and agricultural fields in the project area,<sup>2</sup> a habitat they commonly use for foraging.
- **Burrowing Owl (*Athene cunicularia*).** Burrowing owls are listed as a Species of Special Concern by the CDFG and are presently found in the project corridor. Figure 3.5-2 shows current and previous years nesting areas. A pair of owls were observed using ground squirrel holes (designated "A" in Figure 3.5-2) during a March 1991 field survey by Wetland Research Associates. A single owl was observed in the field adjacent to the railroad tracts near Durham Road during the same period. Burrowing owls have been sighted in February-March 1991 between the two railroad right-of-ways (designated "B" in Figure 3.5-2). In 1989 and 1990, burrowing owls bred and fledged young in three areas of Fremont Central Park (designated "C" in Figure 3.5-2).<sup>3</sup>

---

<sup>1</sup> Ohlone Audubon Society.

<sup>2</sup> Ohlone Audubon Society.

<sup>3</sup> City of Fremont Environmental Services staff.



**Figure 3.5-2  
BURROWING OWL NESTING AND  
ACTIVITY HABITAT IN CENTRAL PARK**

SOURCE: Wetlands Research Associates, 1991

### 3.5 Ecosystems

The current practice of grassland tilling by the City of Fremont as part of their weed control program could potentially seriously impact the owls. Currently, Park Rangers survey the Park prior to each tilling and stake out active owl burrows. The tilling thus spares active owl use areas but destroys other ground squirrel burrows on which burrowing owls depend.<sup>1</sup> The urbanization of grasslands and subsequent destruction of ground squirrel colonies have been the major factors contributing to the demise of burrowing owls.

- **San Francisco Forktail Damselfly (*Ischnura gemina*).** San Francisco forktail damselfly preferred habitat consists of small seepages, shallow ponds and sluggish streams in the San Francisco Bay Area. Wetland areas should be shallow and contain shorelines that are open, sunlit, and composed of low vegetation. Adults benefit from the presence of nearby areas of undisturbed grasslands and fields; these areas provide night roosting and important feeding areas for females and young males. This damselfly is threatened due to the loss of freshwater streams and marshes. Activities such as channeling streams, cleaning flood control channels, and installing underground culverts alter water flow, remove aquatic vegetation needed for egg laying and shelter, and reduce prey abundance.<sup>2</sup>

#### 3.5.2 IMPACTS OF PROPOSED PROJECT AND MITIGATION MEASURES

##### Criteria of Significance

Thresholds of significance for biological resources are derived from State CEQA Guidelines<sup>3</sup> and Professional Standards. These include the following thresholds of significance: 1) substantially affect, reduce the number, or restrict the range of unique, rare, or endangered species of animal or plant, or the habitat of the species; 2) substantially diminish or reduce habitat for fish, wildlife, or plants; 3) interfere substantially with the movement of any resident or migratory fish or wildlife species; 4) change the diversity of species, or the number of any species of plants or animals; 5) deteriorate existing fish or wildlife habitat; and, 6) adversely affect significant riparian lands, wetlands, marshes or other wildlife habitats.

---

<sup>1</sup> Thompson, L.

<sup>2</sup> J. Hafernick, 1989, USFWS Report, *Survey of Potentially Threatened Bay Area Water Beetles and the San Francisco Forktail Damselfly: Final Report.*

<sup>3</sup> State CEQA Guidelines; Appendices G and I and Section 15065A.

**Direct Impacts of the Proposed Project**

The direct impacts discussed below are operational in nature, i.e impacts that would occur during operation of the Proposed Project. Impacts that would occur during or due to construction of the Proposed Project are discussed after direct impacts.

**Urban and Residential Landscaped Areas.** The Proposed Project would have no significant impact on urban and residential landscaped areas.

**Ruderal Forb-grasslands.** Operating impacts consist of increased noise. Hawks, owls, and other wildlife may avoid areas with frequent fast-moving trains over the short-term, but this should not be a significant impact over the long-term as most wildlife are able to acclimate.

Fragmentation of the open ruderal-forb grassland and agricultural fields is a significant operating impact. Large open areas may be critical in attracting raptors to the area. Support structures, embankments and aerial structures divide this habitat into smaller, isolated units.

**Open Water Habitats.** Above ground structures over Lake Elizabeth, New Marsh, and the flood control channels would create shade, which could decrease primary productivity. Given that the areas beneath the tracks would receive sun at some portion of the day, this would be considered a non-significant impact.

Migratory waterfowl and other wildlife that use these open water habitats may be deterred by the increased noise from frequent passage of trains; given the relatively small portion of the lake affected, this would be a less than significant impact.

**Riparian Forest.** In the park as a whole, only 1,100 square feet would be permanently occupied by the 5 foot hexagonal support columns and the rest of the land beneath the aerial structures would be open to public access and nature area uses. Hence, very little of the riparian forest would be displaced by support structures (approximately 14 pillars and 280 square feet) and the structures will be designed to avoid, as much as possible, mature forested areas. However, as noted under construction impacts, the loss of riparian forest from support structures is considered less than significant. The height of the aerial structure, however, may be low enough (13-19 feet above the ground surface) so that the mature riparian forest trees would require removal or cutting to reduce their height. At the lake, the track is 16 feet above the lake surface. Although it rises to pass 23 feet 6 inches above the railroad right-of-way, the track

would still be lower than the riparian forest trees. In addition, BART requires a 4-foot "envelope" surrounding the aerial track structure free from all vegetation. The aerial track is 26 feet wide and with a 4-foot envelope, 34 feet of riparian forest to 4 feet below the bottom of the aerial structure would be eliminated. Where the tracks enter the riparian forest nearest the lake, the riparian forest trees are large and mature, and the aerial structure would still be at the lower extreme in elevation. As the aerial structure increases in elevation nearer the railroad tracks, less vegetation would be affected. Hence, depending on the degree of slope between the lake and the railroad tracks, vegetation height under the 34-foot envelope width would need to be kept from 12 feet to 20 feet tall. This reduction in riparian forest vegetation (approximately 0.75 acres) is a significant operating impact.

In addition, given the relatively low track elevation through the northernmost portion of the riparian forest, shade may cause a problem by altering plant and animal distribution and negatively affect plant species that prefer full sun. This is not a significant impact.

Operating impacts from increased noise from frequent train passage could deter species such as Cooper's hawks, black-shouldered kites, and northern harriers from roosting in the trees. Noise may also deter migratory birds from resting and foraging in the riparian forest. These are considered significant impacts given the rarity of this habitat.

**Emergent Seasonal Wetlands.** There are no significant impacts to the seasonal wetlands due to operating effects of the Proposed Project.

**Jurisdictional Wetlands.** There are no significant impacts to the jurisdictional wetlands due to operating effects of the Proposed Project.

**Rare, Threatened Endangered Species and Species of Special Concern.** The significant impacts to rare, threatened, endangered species and species of special concern due to operating effects of the Proposed Project occur to Cooper's hawks, black-shouldered kites, and northern harriers. (See discussion on riparian forests).

#### **Construction Impacts of the Proposed Project**

**Urban and Residential Landscaped Areas.** The Proposed Project would have no significant impact on urban and residential landscaped areas.

**Ruderal Forb-grasslands.** Breeding and foraging habitat for grassland species, such as owls, foxes, raptors, and shorebirds, would be significantly disturbed over the short-term by construction activities such as earth-moving, noise and movement of heavy machinery. Breeding sites of burrowing owls and foxes directly in the path of construction would be destroyed and those close by may be abandoned due to increased activity from humans and heavy equipment. This would be a significant impact.

It is presently not known if the fox den in the field south of Walnut Avenue is used by native gray foxes or the introduced red foxes. The Proposed Project would eliminate the den as it is directly in the path of the track embankment. It is likely that the foxes would vacate the entire project area and not find a replacement. The loss of a pair of native grey foxes would be significant; the loss of introduced red foxes would be not be significant.

Long-billed curlews, northern harriers, black-shouldered kites, Cooper's hawks, and burrowing owls forage in this habitat. Excavation and construction activities would reduce the foraging area for these raptors and shorebirds, primarily over the short-term. Although a small amount of forb-grassland would be permanently displaced, most would reestablish itself naturally. This would not be a significant impact.

The open fields in the park and surrounding area would be fragmented during construction of the Proposed Project. Large, open areas may be important in attracting foraging raptors to the area. This impact is a short-term significant impact.

One of the large eucalyptus trees south of Walnut Avenue would be removed during construction to accommodate the embankment. However, the presence of nearby eucalyptus trees in the same field and at Tule Pond provides alternative roosting and nesting sites for small birds and hawks, so the level of impact would be less than significant.

**Open Water Habitats.** Short-term construction impacts to Lake Elizabeth would result from draining an arm of the lake in order to build the aerial structure. Draining part of the lake would result in the temporary loss of fish habitat and other aquatic animal habitat and would destroy aquatic and emergent vegetation. This would also result in the temporary loss of foraging, roosting, and breeding habitat for a number of wildlife species (Table 3.5-1), a significant short-term impact. Some wintering waterfowl and species such as herons and egrets that use the shoreline would not use the arm of the lake while it is drained. Although only a portion of the lake would be drained, this would be considered a significant short-term impact. Mitigation (see below) would reduce its level of significance.

Excavated soil and construction materials (e.g. cement wash, grease, oil) may pollute the undrained portion of the lake, the drained lake bottom, New Marsh and Tule Pond, adversely affecting animal and plant populations, but would not be considered significant given construction precautions discussed for implementation in the mitigation section.

Other open water areas that will be impacted include New Marsh and Tule Pond (Figure 3.5-1). New Marsh is to the northeast of the proposed aerial alignment, but will be impacted by construction activities only to the extent that wildlife will be deterred from using it by construction noise and human activity; it is a temporary and less than significant impact. The northern portion of Tule Pond is adjacent to the existing Fremont BART station. While not directly in the project alignment, construction activities and earth-moving activities may deter wildlife from using it; however, given the pond's proximity to the existing BART station, this can be viewed as a remote and non-significant impact.

Flood control channels that have earth banks with emergent marsh vegetation (Mission Creek and the channel north of Paseo Padre Parkway) support a variety of wildlife (Table 3.5-1). Soil excavation, heavy equipment movement, and other construction activities may alter water flow in the channels, cause erosion and increased sedimentation, degrade the vegetation, and deter some animals from using these wetland habitats. Such impacts to water flow in the channels, although short-term, are considered significant.

The San Francisco forktail damselfly (a Federal Candidate 2 species) may occur in this habitat and could be affected by construction of the project. Activities that alter water flow or that remove aquatic vegetation may impact the damselfly by reducing prey abundance and disturbing egg-laying sites and shelter. These impacts would be considered significant in regard to the San Francisco forktail damselfly.

**Riparian Forest.** The Proposed Project alignment passes directly over and through the north corner of the riparian forest to the east of Lake Elizabeth. This forest supports a diverse group of wildlife (Table 3.5-1) and represents a remnant of a more widespread habitat that is rapidly disappearing. The proposed alignment passes through a major portion of the riparian forest. The BART right-of-way is 50 feet wide, and essentially all of the riparian forest within the right-of-way would be eliminated during construction.<sup>1</sup> In total, this is approximately one acre (.28 acres between Lake Elizabeth and Mission Creek; .68 acres between Mission Creek and the railroad tracks; and .1 acres adjacent to Paseo Padre Boulevard). Loss of this habitat area

---

<sup>1</sup> BART engineering staff.

during construction would result in significant impacts, including a decline in the biological diversity of the project area, during the 5 to 15 years it would take for mature riparian forest to regenerate.

**Emergent Seasonal Wetlands.** Construction for the track embankment south of Walnut Avenue would partially fill 1.5 acres of the seasonal wetland. This would result in a long-term significant adverse impact to marsh vegetation and to wildlife species that use this habitat (Table 3.5-1).

**Jurisdictional Wetlands.** Waters of the United States and adjacent wetlands potentially subject to Army Corps of Engineers jurisdiction under Section 404 of the Clean Water Act have been identified within the project area. In addition to wildlife and habitat impacts described above, any "fill" placed in jurisdictional wetlands or waters of the United States is subject to a Corps of Engineers permit under the Clean Water Act.

**Rare, Threatened, and Endangered Species and Species of Special Concern.** The following discussion is on the construction impacts on rare, threatened, and endangered species and species of special concern.

- **Hoover's Button-celery.** Hoover's button-celery occurs in freshwater seasonal wetlands. Possible locations on the Proposed Project alignment are in the seasonal wetland south of Walnut Avenue (the southern portion of Tule Pond) and in the other possible seasonal wetlands between the two railroad right-of-ways east of Lake Elizabeth. The filling of the seasonal wetland south of Walnut Avenue would be a significant impact to Hoover's button-celery, if present; however, it has not been identified at these sites to date.
- **Delta Tule-pea.** The Delta tule-pea, a salt-brackish marsh species, has an extremely low probability of being on the Proposed Project alignment, and therefore no impacts are expected. None were observed during a July 1991 field survey for this species.<sup>1</sup>
- **Long-billed Curlews.** Long-billed curlews forage in the ruderal-forb grasslands and agricultural areas during migration periods. Construction activities may deter these birds from foraging near the Proposed Project alignment, but this is considered a less than significant impact (see discussion of impacts in section on ruderal-forb grassland and agricultural fields).

---

<sup>1</sup> Wetlands Research Associates, 1991.



- **Tri-colored Blackbirds.** If present, draining of an arm of Lake Elizabeth, and the loss of shoreline emergent vegetation, would adversely affect these birds. However, tri-colored blackbirds have not been observed in the Proposed Project alignment or in Central Park since the large freshwater marsh was converted to Lake Elizabeth. Therefore, no impacts are expected.
- **Northern Harrier, Black-shoulders Kite, and Cooper's Hawk.** These species forage in the ruderal-forb grassland and agricultural fields. As discussed under construction impacts on ruderal forb-grasslands, construction activities and habitat fragmentation are considered adverse significant impacts that may deter these species from using the area.
- **Burrowing Owls.** These owls forage and breed in ruderal forb-grassland and agricultural fields. Construction activities may directly impact the owls by destroying their burrows and active nest sites. Habitat fragmentation may also deter the owls from foraging in the area. Both of these impacts were considered significant adverse impacts, as discussed under construction impacts on ruderal forb-grasslands.
- **San Francisco Forktail Damselfly.** If present, the damselfly would suffer significant impacts from any alteration of water flows or vegetation loss in the flood control channels, as discussed under construction impacts on open water habitats.

#### Mitigation Measures

**Ruderal Forb-grassland.** If the fox den in the field south of Walnut Avenue is used by native gray foxes, the foxes should be relocated to mitigate the significant impacts the project would create. Trapping and moving procedures and relocation sites would be approved by CDFG prior to implementation. Locating the foxes to another portion of Fremont Central Park will not create any significant environmental impacts. A mitigation monitoring plan will be carried out to ensure implementation of the fox relocation. BART will also develop a contingency plan to be used only in the event that the fox relocation is not successful. This contingency plan will define other methods of impact mitigation including fee mitigation, and will be developed with concurrence from CDFG. With implementation of these measures, the impacts will be reduced to a less-than-significant level.

Burrowing owls could be significantly impacted by construction occurring within their breeding areas. Prior to construction, a field survey of the burrowing owls should be conducted to

identify the location of each burrow existing at that time. Fencing should be used to cordon-off those burrows, as possible, from construction activity disturbance. All owls that cannot be kept from disturbance will be trapped, moved and relocated as approved by CDFG. All activities would be approved by CDFG prior to implementation. A mitigation monitoring plan will be carried out to ensure implementation of the relocations. Ground squirrels should be actively encouraged to reestablish the burrow systems on which the burrowing owls depend; although not under BART's control, curtailing tilling in the Central Park grassland by the City of Fremont would help accomplish this goal. BART will also develop a contingency plan, to be used only in the event that the burrowing owl relocation is not successful. This contingency plan will define other methods of impact mitigation, including fee mitigation, and will be developed with concurrence from CDFG. With implementation of these measures, the impacts will be reduced to a less-than-significant level.

Areas of ruderal forb-grassland and agricultural areas would be irrevocably lost to embankments, support structures, stations, and parking lots, creating fragmented habitat. However, the fragmentation of this habitat can be reduced by retaining wildlife corridors between fields. The ruderal grassland disturbed or destroyed by construction activities would be replaced with a native grassland community or other appropriate habitat. Reestablishment of a native grassland would also provide foraging areas for Cooper's hawks, northern harriers, black-shouldered kites, long-billed curlews and numerous other animals that use grassland habitats (Table 3.5-1). The ruderal forb-grasslands and agricultural fields may reestablish naturally. However, to assure pre-project conditions, top soil should be replaced and a mixture of native perennial and annual grasses (*Bromus carinatus*, *Elymus triticoides*, *Hordeum brackyantherum*), and forbs (*Eschscholzia californica*, *Lupinus bicolor*) should be seeded in the late fall after the topsoil is replaced. With mitigation, impacts of the Proposed Project on ruderal forb-grassland would be reduced to a less than significant level, except for the impact of habitat fragmentation.

**Open Water Habitats.** Fish and emergent vegetation destroyed or removed by draining would be replaced following completion of construction. After refilling the drained portion of the lake, fish will naturally move into the area from the non-drained portions of the lake. Emergent vegetation lost during the construction period should be replaced with a mixture of alkali bulrush (*Scirpus robustus*), hardstem bulrush (*Scirpus acutus*), knotweed (*Polygonum lapathifolium*), and arroyo willow (*Salix lasiolepis*). Replacement densities of plants should be 3 feet on center for *Salix* and *Scirpus* species, and 2 feet on center for *Polygonum*. *Salix* is planted from 1-inch diameter cuttings, 8 inches long, whereas *Scirpus* and *Polygonum* are reestablished from plugs (root, rhizome associated soil). All plant materials are to be obtained from established native stands in the area. *Scirpus* and *Polygonum* should be planted in April-

May following construction and *Salix* in December-February. This will reduce the impact to a less than significant level. Wildlife species that use this habitat, including wintering species, will return once the habitat has been re-established. Short-term impacts due to construction activities would be significant.

Construction equipment and materials should be stored away from Lake Elizabeth, New Marsh, and Tule Pond. Specific areas for storing this equipment should be defined prior to construction and should occur on paved areas. The construction contractor will be required to use erosion barriers in order to prevent construction materials and excavated soils from entering any of the open water areas directly or through erosion. With implementation of these measures, these impacts will be reduced to a less than significant level.

Possible impacts to the flood control channels include water diversion, degradation from heavy machinery, and avoidance of the area by wildlife. No support structures should be placed in the flood control channels. Water flows through the channels and into the riparian forests should be maintained not only as required for flood control, but to maintain existing wildlife habitat values. Destroyed vegetation would be replaced, as described above for Lake Elizabeth, and the channels returned to their previous condition following construction. At present, these flood control channels are steeply banked and are vegetated only along the bottom of the water course. The effect of construction activities in deterring wildlife use of the area during construction cannot be mitigated, which could result in a significant short-term impact.

If the San Francisco forktail damselfly is present in the flood control channels, even the temporary disturbance to water flows or vegetation could adversely affect their population status and would be considered a significant impact as discussed above. Such disturbance cannot be mitigated.

**Riparian Forest.** The temporary loss of riparian forest during construction activities is a significant impact. To reduce the degree of impact to the riparian forest, construction activities should be kept away from the riparian forest as much as possible. Therefore, as little forest should be removed or disturbed as possible. The one acre of riparian forest lost during construction should be replanted and the .75 acre lost to the aerial structure and associated 4-foot envelope and the support structures should be replaced along the flood control channels in Central Park. With implementation of these measures, impacts would be reduced below a level of significance. The loss in habitat quality for migratory birds due to noise from BART train passage through the riparian forest may be mitigated to a less than significant level by soundwalls as detailed in Section 3.13, Noise and Vibration.

**Emergent Seasonal Wetlands.** The 1.5 acres of seasonal wetland south of Walnut Avenue (the southern portion of Tule Pond) would be eliminated by construction. This area currently serves as a seasonal storm retention basin to prevent flooding of adjacent areas. Mitigation for loss of this area would require both flood control and wetland habitat elements. This basin should be moved to the west of its present location and would thereby retain not only flood control, but wildlife habitat values. A similar hydrological regime would be established (see Section 3.4, Hydrology) and wetland vegetation would be replanted. Plant species and planting methodologies would follow those described listed under "Open Water Habitats." Short-term habitat values lost during construction would be unmitigable and significant, but long-term significant impacts would be mitigated to a less than significant level.

**Jurisdictional Wetlands.** According to Clean Water Act Section 404 (b)(1) guidelines, all jurisdictional wetland fill must be avoided, minimized, or compensatory mitigation provided by a minimum one-for-one functional replacement basis. The Proposed Project avoids jurisdictional wetlands if possible; where it is not possible, one-for-one replacement will be provided.

**Rare, Threatened, and Endangered Species and Species of Special Concern.** The following discussion is on mitigation measures for project impacts on rare, threatened, and endangered species and species of special concern. A mitigation monitoring plan will be carried out to ensure implementation of the mitigation measures. BART will also develop a contingency plan to be used only in the event that the mitigation measures are not successful. This contingency plan will define other methods of impact mitigation including fee mitigation and will be developed with concurrence from CDFG or USFWS, as appropriate.

- **Hoover's Button-celery.** If present on the Proposed Project alignment, populations of this species would need to be relocated to a mitigation site as deemed appropriate by the USFWS prior to construction. With mitigation, impacts would be less than significant.
- **Northern Harrier, Black-shouldered Kite, and Cooper's Hawk.** No mitigation is possible for either the short-term impacts during the construction period or the long-term impacts of habitat fragmentation (see sections on impacts and mitigations in ruderal forb-grasslands and agricultural fields).
- **Burrowing Owl.** As discussed under mitigations of ruderal forb-grasslands and agricultural fields, a field survey for burrowing owls should be conducted to identify the

location of all owls in the Proposed Project alignment prior to construction. Owls directly in the path of construction would be relocated as approved by CDFG biologists. With successful mitigation, impacts would be less than significant.

- **San Francisco Forktail Damselfly.** If present, altering waterflows or removing emergent vegetation from the flood control channels would be a significant impact to the damselfly, as discussed above. Given their typically small local population size and highly isolated population structure, even a temporary disturbance is significant and cannot be mitigated.

As discussed above for burrowing owls and foxes, contingency plans will be included in the overall mitigation monitoring program.

#### **Cumulative Impacts and Mitigation**

Oak woodlands, riparian forest, and seasonal wetlands were once significant habitats in the area. Residential and commercial development in the area has reduced these habitats to scattered fragments. The Proposed Project would continue this process. Significant cumulative impacts to the habitats from the Proposed Project may result from habitat fragmentation. If the habitat becomes highly fragmented into small and isolated units, the area becomes less suitable as breeding and foraging habitat for burrowing owls, Cooper's hawks, northern harriers, black-shouldered kites (Species of Special Concern), and long-billed curlews (a USFWS Candidate 2 species), as well as for other species (Table 3.5-1). No mitigation is possible for this cumulative impact.

Nearly all of the remaining grassland habitats south of Paseo Padre Boulevard are zoned commercial for industrial development. Conversion to light-industrial uses can be expected with or without the Proposed Project. Therefore, the long-term cumulative impacts of the Proposed Project in conjunction with the development allowed by the Fremont General Plan are significant.

#### **Residual Impacts After Mitigation**

Residual impacts of the Proposed Project after mitigation are as follows:

- 1) temporary loss of foraging, roosting, wintering and breeding habitat for wildlife species associated with draining an arm of Lake Elizabeth during construction (see discussion of construction impacts on open water habitats)
- 2) temporary loss of riparian forest due to construction activities (see discussion of construction impacts on riparian forest)
- 3) temporary loss of flood control channel wildlife, including the San Francisco forktail damselfly, if present (see discussion of construction impacts on open water habitats)
- 4) habitat fragmentation (see discussion on cumulative impacts and mitigation)

### 3.5.3 IMPACTS OF DESIGN OPTIONS AND MITIGATION MEASURES

#### Design Option 1

Design Option 1 differs from the Proposed Project in that tracks are in a subway from Stevenson Boulevard to Paseo Padre Parkway. It also differs from the Proposed Project in that a greater area would be affected because of the necessity of excavating, storing, and removing large amounts of soil for the underground structures. These impacts and resulting mitigations related to Design Option 1 are discussed below.

**Impacts.** Construction activity impacts of Design Option 1 in the ruderal forb-grasslands and agricultural areas, open water habitats, riparian forest, and jurisdictional wetlands differ from those of the Proposed Project in the subway section of the alignment. Soil would be excavated, stockpiled, and removed from the project site, further decreasing breeding and foraging areas in these habitats during construction and for a longer period of time. As with the Proposed Project, an arm of Lake Elizabeth would be drained, resulting in temporary, significant impacts. However, for the underground portion of the alignment, Design Option 1 differs from the Proposed Project in that there are no permanent construction, operational, or residual impacts.

**Mitigation.** Mitigation in the ruderal forb-grasslands and agricultural fields, open water habitats, riparian forest, and jurisdictional wetlands differs from the Proposed Project in the subway section. During construction, measures necessary to prevent erosion and pollution from the excavated and stockpiled soil would be implemented. After construction, vegetation destroyed and disturbed vegetation would be replaced adjacent to and over the subway section in the

manner specified for each habitat in the proposed project mitigation above. Mitigations for dewatering an arm of Lake Elizabeth are the same as for the Proposed Project.

#### **Design Option 2A**

Design Option 2A differs from the Proposed Project in that the tracks are aligned to the east around Lake Elizabeth and directly over New Marsh and Mission Creek flood control channel. This alignment avoids direct impacts to Lake Elizabeth and the adjacent riparian forest. Thus, under this design option, construction impacts and mitigations for the ruderal forb-grassland and agricultural areas are identical to those of the Proposed Project except that the impacts on Lake Elizabeth and the adjacent riparian forest would be avoided since the tracks would not pass directly through these areas as with the Proposed Project. Under Design Option 2A, the tracks would pass directly over New Marsh, resulting in the same operational impacts as described for Lake Elizabeth under the Proposed Project. Mission Creek flood control channel would also be under the alignment, resulting in the impacts and mitigations described above.

**Impacts.** New Marsh would be significantly impacted under Design Option 2A, since in this design option the alignment passes directly overhead. In addition to the impacts and mitigations under the Proposed Project, this design option would reduce light, possibly increase pollution, and increase noise and vibration, overall decreasing the wildlife value of the wetland. The net effect would be a decrease in the overall value of the wetland.

The tracks would also pass over Mission Creek flood control channel. The construction impacts to the flood control channels were discussed previously.

**Mitigation.** New Marsh would require relocation in its entirety. A new pond could be excavated to the west of New Marsh in the depression adjacent and north of Lake Elizabeth. The new pond should be identical in size and vegetated according to the procedures outlined above under mitigation of impacts on open water habitats. Mitigations for the flood control channels were discussed under the Proposed Project.

#### **Design Option 2S**

Under this design option, the horizontal alignment is the same as Design Option 2A but would be subway from Stevenson Boulevard to just after Paseo Padre Parkway.

### 3.5 Ecosystems

**Impacts.** Construction period impacts would be similar to those of the subway portion of Design Option 1 in the ruderal grassland and agricultural areas. Because Design Option 2S passes directly through New Marsh, this pond would be eliminated during construction. Lake Elizabeth and the riparian forest east of Lake Elizabeth are entirely avoided under this design option and thus would suffer no significant construction, operating, or residual impacts. The Mission Creek flood control channel and the flood control channel and associated riparian forest adjacent to and north of Paseo Padre Parkway would have significant construction period impacts from destruction of channels and riparian forest.

**Mitigation.** Mitigation for the impacts to the ruderal forb-grassland and agricultural areas are the same as for Design Option 1. The elimination of New Marsh would require that a new wetland be created as a replacement in a suitable area as described above under design option 2A mitigations. Water flows through Mission Creek and the flood control channel adjacent to and north of Paseo Padre Parkway should be maintained so as not to affect the emergent vegetation in the channels, forktail damselfly, if present, and riparian areas downstream. After construction, water flows should be returned to current levels and vegetation replanted in the flood control channels as described under the Proposed Project mitigations of open water habitats. Mitigation for the destruction of the riparian forest adjacent to Paseo Padre Parkway would entail replanting willows along the reconstructed water course. Although a fairly long-term impact, after 15-20 years, the riparian forest would be reestablished. Hence, there would be no residual long-term impacts of Design Option 2S.

#### Design Option 3

Under this option, the alignment is east of Design Options 2A and 2S. This alignment passes to the east of New Marsh and avoids Lake Elizabeth and the adjacent riparian forest. It passes over Mission Creek flood control channel, the channel north of Paseo Padre Boulevard, and the adjacent riparian forest. Construction impacts and mitigations for ruderal forb-grassland and agricultural areas are identical to that of the Proposed Project. Impacts to the riparian forest adjacent to Paseo Padre Parkway would be the same as for the Proposed Project.

**Impacts.** Design Option 3 passes directly over Mission Creek flood control channel. Impacts to flood control channels were discussed in the section for the Proposed Project.

**Mitigations.** Mitigations for impacts to the flood control channels are discussed in the mitigation section of the Proposed Project.



#### **Paseo Padre Parkway Design Option**

With this option at Paseo Padre Parkway, the BART alignment would be at-grade and Paseo Padre Parkway would go over BART, SPTCo and UPRR. This design option would have the same impacts and mitigations as the Proposed Project except in the area of Paseo Padre Parkway.

**Impacts.** Tracks at-grade in the area north and adjacent to Paseo Padre Parkway would result in disturbance and destruction of the vegetation in the flood control channel and of the adjacent riparian forest. Impacts and loss of these habitats are the same as for the Proposed Project.

**Mitigations.** Mitigation for this habitat loss should include rerouting the flood control channel to the north to pass under the elevated portion of the tracks and replanting emergent and riparian vegetation, as discussed previously. This would result in extended short-term impacts, but after the riparian vegetation is reestablished, no residual long-term significant impacts are expected.

#### **Washington Boulevard Design Option**

Impacts and mitigations, including residual impacts, are the same for this design option as for the Proposed Project.

#### **Warren Avenue Design Option**

Impacts and mitigations, including residual impacts, are the same for this design option as for the Proposed Project.

#### **UPRR Relocation Design Option**

Impacts and mitigations, including residual impacts, are the same for this design option as for the Proposed Project.

### **3.5.4 IMPACTS OF ALTERNATIVES AND MITIGATION MEASURES**

There are eleven project alternatives. The first three are non-BART alternatives that do not impact the project area directly. The other eight alternatives (Alternatives 4-11) involve

different BART track alignments, track length, and number of stations. The applicability of the design options to these BART alternatives are discussed in Chapter 2, Project Description. Thus, for any of the alternatives discussed below, the impacts and mitigations of the various design options may apply. However, the build alternatives themselves differ only in the alignments south of Paseo Padre Parkway, and the only two habitats in this area are ruderal forb-grassland and rip-rap or concrete-lined flood control channels. Because the latter habitat is of no value to wildlife, construction and operating impacts and mitigations of the project alternatives will focus on the ruderal forb-grassland and agricultural areas. South of Paseo Padre Parkway, these latter habitats exist as fields surrounded by light industry, shopping centers, and houses. Although fragmented, these areas may still support burrowing owls and provide foraging and breeding habitat for other species (Table 3.5-1).

#### **Impacts of Alternative 4: A 5.4-Mile BART Extension (Relocated SPTCo and UPRR) - Two Stations**

This alternative would have fewer construction impacts on ruderal forb-grassland and agricultural areas because the South Warm Springs Station is eliminated and the total length of the extension is reduced by 2.4 miles. Fewer fields south of Paseo Padre Parkway will be disturbed or eliminated by construction and operating impacts. Construction and operating impacts and mitigations for the ruderal forb-grassland and agricultural areas were discussed previously. Since this alternative has less station and less track than the Proposed Project, the residual and cumulative impacts would be less than the Proposed Project.

#### **Impacts of Alternative 5: A 5.4-Mile BART Extension (Proposed Project Alignment) - Two Stations**

This alternative follows the same route as the Proposed Project but the South Warm Springs station is eliminated and the total length of the extension is reduced by 2.4 miles. Construction and operating impacts and mitigations would be identical to the Proposed Project in the area of construction, i.e., from Fremont BART Station to approximately 3,000 feet south of the Warm Springs Station. Since this alternative has one less station and less track than the proposed project, the residual and cumulative impacts would be less than under the Proposed Project.

**Impacts of Alternative 6: A 7.8-Mile BART Extension (Proposed Project Alignment Without Irvington Station) - Two Stations**

Construction and operating impacts and mitigations would be identical to that of the Proposed Project except the Irvington Station is eliminated resulting in significantly fewer construction and operating impacts on the ruderal forb-grassland area at this locale. Since this alternative has one less station than the proposed project, the residual and cumulative impacts would be less than the Proposed Project.

**Impacts of Alternative 7: A 7.8-Mile BART Extension (Aerial Without Irvington Station) - Two Stations**

This alignment differs from the Proposed Project in that the tracks and stations are elevated and the Irvington station is eliminated. Construction and operating impacts and mitigations therefore differ from the Proposed Project to the extent that fewer ruderal forb-grassland and agricultural areas need to be filled and they also may be reestablished under the aerial structures. Since this alternative has one less station than the Proposed Project, the residual and cumulative impacts would be less than under the Proposed Project.

**Impacts of Alternative 8: A 7.8-Mile Extension (Osgood Road and Warm Springs Boulevard Alignment Without Irvington Station) - Two Stations.**

This aerial alignment follows Osgood Road and would not have an Irvington Station. As a result, this alignment which would result in significantly fewer construction and operating impacts and mitigations to ruderal forb-grassland area than would occur under the Proposed Project. Since this alternative also has one less station than the Proposed Project, the residual and cumulative impacts would be less than under the Proposed Project.

**Impacts of Alternative 9: A 5.4-Mile BART Extension - One Station (Warm Springs District)**

This alternative follows the same route as the Proposed Project but includes one station in the Warm Springs District and has only 5.4 miles of track. Construction, operating, cumulative, and residual impacts and mitigations would be significantly less than under the Proposed Project, since, with fewer stations and less track there will be fewer impacts because less grassland habitat would be impacted.

**Impacts of Alternative 10: A 7.8-Mile BART Extension - One Station (South Warm Springs)**

This alignment follows the same route as the Proposed Project but the Irvington and Warm Springs Stations would be eliminated. Construction, operating, cumulative, and residual impacts and mitigations are less than the Proposed Project. With fewer stations, there will be fewer impacts because less grassland habitat would be impacted.

**Impacts of Alternative 11: A 7.8-Mile BART Extension - Two Stations (Irvington and South Warm Springs)**

This alignment follows the same route as the Proposed Project but the Warm Springs Station would be eliminated. Construction, operating, cumulative, and residual impacts and mitigations are less than under the Proposed Project. With one less station, there will be fewer impacts because less grassland habitat would be affected.

## 3.6 LAND USE AND ECONOMIC ACTIVITY

### 3.6.1 SETTING AND EXISTING CONDITIONS

#### Population

The Proposed Project is located in the City of Fremont in southern Alameda County. In the last decade (1980-1990), the population of Alameda County increased by approximately 14 percent for a total of 1,260,604 (see Table 3.6-1). As of 1990, the majority of residents in Alameda County were Caucasian (65.8 percent), 20.4 percent were Black, 11.3 percent were Asian, 1.0 percent were American Indian, and 1.6 percent were "other." The portion of the populace which identified itself as being of Hispanic origin was 11.8 percent.

Fremont is one of the fastest growing cities in Alameda County. Between 1980 and 1990, its population increased by approximately 37 percent, reflecting a rate of residential growth that began in the 1960s and continued throughout the 1970s and 1980s. The median household income in Fremont (\$44,622) is higher than the median household income in Alameda County (\$31,082). In the last decade, household median income in Fremont also increased at a higher rate than the County median.

#### Housing Characteristics

Although the rate of residential growth in Fremont was slower between 1980 and 1990 than between 1970 and 1980, Fremont continues to expand its housing stock at a higher rate than Alameda County. The expansion is reflected in the relative age of the housing stock: in 1980,

#### Notes on Population Estimates

*Information on population characteristics is provided by the U.S. Census Bureau. Although a census was conducted in 1990, only preliminary data are available at this time covering population and race. Consequently, this section of the EIR draws upon a number of other data sources to describe existing conditions in Alameda County and the City of Fremont. For example, Urban Decision Systems (UDS) provides data on 1990 population characteristics. UDS utilizes a number of data sources, including the Department of Finance estimates, information from the Department of Motor Vehicles, and the 1980 U.S. census, to estimate 1990 population characteristics. Other information sources used here include ABAG's 1990 Projections and preliminary census tract data covering population and race. Where appropriate, projections of employment, population, and housing units provided by the City of Fremont have also been incorporated into this section.*

**Table 3.6-1**  
**Population Characteristics**  
**Alameda County and Fremont**

	1980	1990 <sup>1</sup>	% Change 1980 to 1990 <sup>2</sup>
<b>ALAMEDA COUNTY</b>			
Total Population	1,105,379	1,260,604	14%
Number of Households	426,092	477,082	12%
Income of All Households			
Mean	\$21,838	\$39,456	10.1%
Median	\$18,700	\$31,082	1.2%
<b>FREMONT</b>			
Total Population	131,945	180,673	36.9%
Number of Households	44,124	61,658	39.7%
Income of All Households			
Mean	\$27,062	\$49,314	11%
Median	\$25,361	\$44,622	7.2%

<sup>1</sup> 1990 Numbers are estimates.

<sup>2</sup> Although dollar amounts presented in this table are unadjusted, for purposes of calculating a percentage change between 1980 and 1990, dollar amounts have been adjusted to the base year of 1967 using the CPI for all items (San Francisco-Oakland: 1980= 2.473 and 1990= 4.060).

Sources: 1980 U.S. Census, and URBAN Decision Systems.

less than 20 percent of all housing units in Alameda County were 10 years old or less, but in Fremont the comparable figure was 40 percent.<sup>1</sup> However, in the last few years the rate of new residential construction has slowed (Table 3.6-2). This slowdown in new residential construction follows national trends, and in the short run is likely to continue.

The majority of housing units in Fremont are either single family houses or small, multiple-rental properties of four units or less. However, in the five year period from 1984 to 1989, the construction of larger multifamily housing buildings (with five or more units) increased by five

<sup>1</sup> Detailed housing characteristics from the 1990 Census will not be available until 1992.

**Table 3.6-2  
Building Permit Activity in Fremont, 1987 - 1990**

	Residential # Single Family Units	# Multi- Family Units	Total Residential Valuation	Total Non-Residential Valuation
1990	281	277	\$95,502,000	\$285,289,000
% change 89-90	-65%	-46%	-47%	-3%
1989	797	510	\$180,992,000	\$294,489,000
% change 88-89	-46%	-34%	-29%	-17%
1988	1,467	767	\$254,669,000	\$353,123,000
% change 87-88	-9%	53%	8%	1%
1987	1,620	500	\$236,806,000	\$349,476,000

Source: Construction Industry Research Board, *Building Permit Summary, California Cities and Counties*.

percent. The average price of a home in Fremont increased dramatically between 1970 and 1980, and has continued to rise until 1990. The average sales price of existing housing (of all types) rose 93 percent (\$118,379 in 1983 to \$228,995 in 1989).<sup>1</sup> In the last year, the rate of increase has abated.

### Employment Trends

Between 1979 and 1989, employment in manufacturing in Alameda County declined by 5,500 jobs while service employment grew by 51,200 jobs. Total employment in Alameda County in 1989 was 598,700.<sup>2</sup> Table 3.6-3 compares actual 1980 employment figures in Fremont by major industrial sector with the Association of Bay Area Governments' (ABAG) projections for the years 1990 and 2005.

<sup>1</sup> City of Fremont, *Housing Background Report*, Fremont General Plan, Preliminary Draft II, March 1991, page 15.

<sup>2</sup> State of California, Employment Development Department/*Annual Planning Information Alameda County*, June 1990.

**Table 3.6-3**  
**Employment in Fremont: 1980, 1990 and 2005**

	1980 (Actual)	1990 (Estimated)	2005 (Projected)
Total Employed	33,711	55,870	95,400
Percentage Employed In:			
Agriculture & Mining	3%	2%	0.5%
Manufacturing & Wholesale Trade	12%	21%	30%
Retail Trade	25%	25%	22%
Services	35%	30%	27%
Other <sup>1</sup>	25%	22%	20%
Employed Residents	67,169	97,300	119,700
Commuters to Other Areas	33,458	41,430	24,300

Source: Association of Bay Area Governments, Projections '90.

<sup>1</sup>Other includes jobs in construction, transportation, communication, utilities, finance, insurance, real estate and government.

Services and retail trade together accounted for 60 percent of total employment in Fremont in 1980; but they are projected to decline to 49 percent by the year 2005. Manufacturing, which accounted for 12 percent of all employment in 1980, is projected to increase to 30 percent by 2005. This is partly due to projected growth in the area of high-technology industrial development, which is included under the manufacturing category. New United Motors Manufacturing Inc. (NUMMI) is the largest private employer in Fremont and is the only non-computer-related major manufacturer in the City.

Employment projections are also available from the City of Fremont based on a survey of current and projected land uses. Fremont estimates that there will be approximately 120,100 jobs by the year 2010.<sup>1</sup> This is a higher level (approximately 15,000 jobs) than would be seen if ABAG's projections are extended from the year 2005 to 2010.

<sup>1</sup> City of Fremont, *Fremont General Plan, Preliminary Draft II*, March 1991, page 3-7.



In 1980, almost half of the labor force commuted out of Fremont for jobs. Although the pattern of commuting to other cities for jobs will continue until the year 2005 and beyond, the percentage of the labor force commuting out of the City will decline due to the increase in local employment.

#### **Socioeconomic Projections**

Table 3.6-4 presents ABAG projections for growth in Alameda County and Fremont for the period from 1980 to 2005. It is projected that the number of households and the population in Fremont will both grow at rates almost double that of Alameda County. While the median household income in Fremont will remain higher than in Alameda County, the annual rates of increase in income are projected to be similar in both the City and County.<sup>1</sup>

#### **Land Uses and Zoning**

The following discusses both current land uses and the City's General Plan land use designations<sup>2</sup> for areas along the Proposed Project alignment, including the three proposed BART station impact areas. (A station impact area is often defined as the area within easy walking distance of the station. That distance, usually ranging between ¼ to ½ mile, can be less if there are pedestrian barriers.) Figures 3.6-1 and 3.6-2 summarize current land uses and General Plan land use designations in the study area.

#### **Existing Land Use**

The existing Fremont BART Station is located within the central business district (CBD), which has high density development. In general, mid-rise office buildings are located to the west, and multifamily complexes are located to the east. Large tracts of land are still available around the CBD for further intensive development. As the alignment moves south and crosses over Stevenson Boulevard, it enters Fremont Central Park and the Civic Center area. Except for the new main library, city offices and associated public structures, that area is recreational open space.

---

<sup>1</sup> The City of Fremont has also prepared housing and population projections to the year 2010; these projections are lower than the corresponding ABAG estimates. However, differences in projection methodology or geographic boundaries may account for some of the discrepancies.

<sup>2</sup> For purposes of this study, Preliminary Draft II of the General Plan was used. The Final Plan, adopted on May 7, 1991, included minor changes, according to Janice Stern, Associate Planner, City of Fremont, May 23, 1991.

**Table 3.6-4  
Growth Projections, 1980-2005  
Alameda County and Fremont**

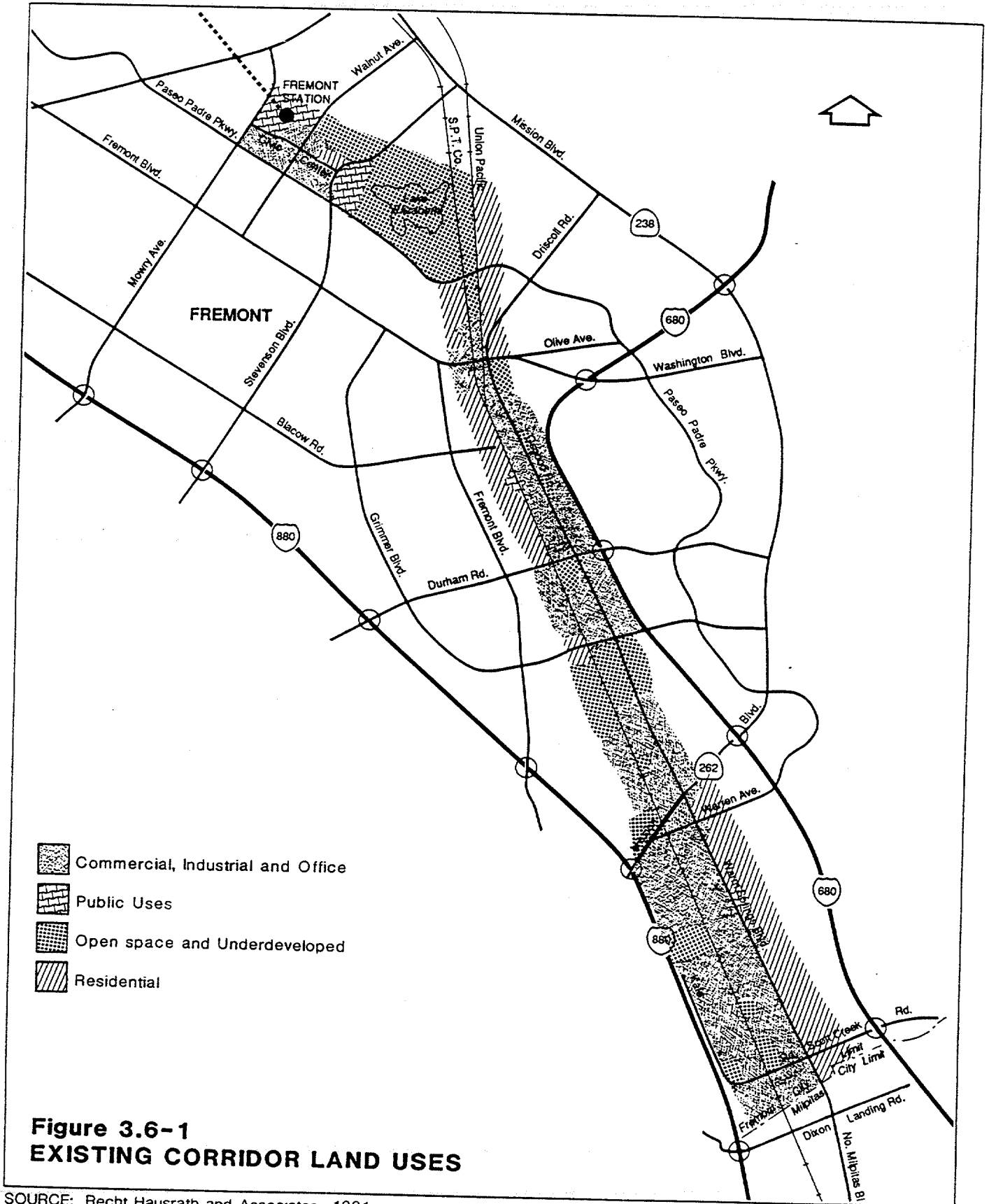
	1980	1990	1995	2000	2005	% Change 1980-2005
<b>ALAMEDA COUNTY</b>						
Population	1,105,379	1,272,000	1,330,800	1,387,900	1,444,600	30.7%
Households	426,093	491,610	519,520	547,320	572,420	34.3%
Household Size	2.53	2.51	2.48	2.46	2.44	-3.6%
Employment <sup>1</sup>	511,133	608,480	675,410	740,600	783,350	53.3%
Employed Residents	522,069	647,500	707,000	752,400	778,900	49.2%
Mean Household Income in Constant 1988 Dollars	\$35,609	\$40,100	\$43,000	\$45,100	\$46,900	31.7%
<b>FREMONT</b>						
Population	131,960	175,200	188,900	198,300	203,600	54.3%
Households	44,129	61,190	67,220	71,320	73,410	66.4%
Household Size	2.96	2.82	2.77	2.74	2.73	-7.8%
Employment <sup>1</sup>	33,711	55,870	72,770	86,230	95,400	183.0%
Employed Residents	67,169	97,300	108,900	117,700	119,700	78.2%
Mean Household Income in Constant 1988 Dollars	\$44,231	\$49,300	\$52,700	\$55,500	\$58,000	31.1%

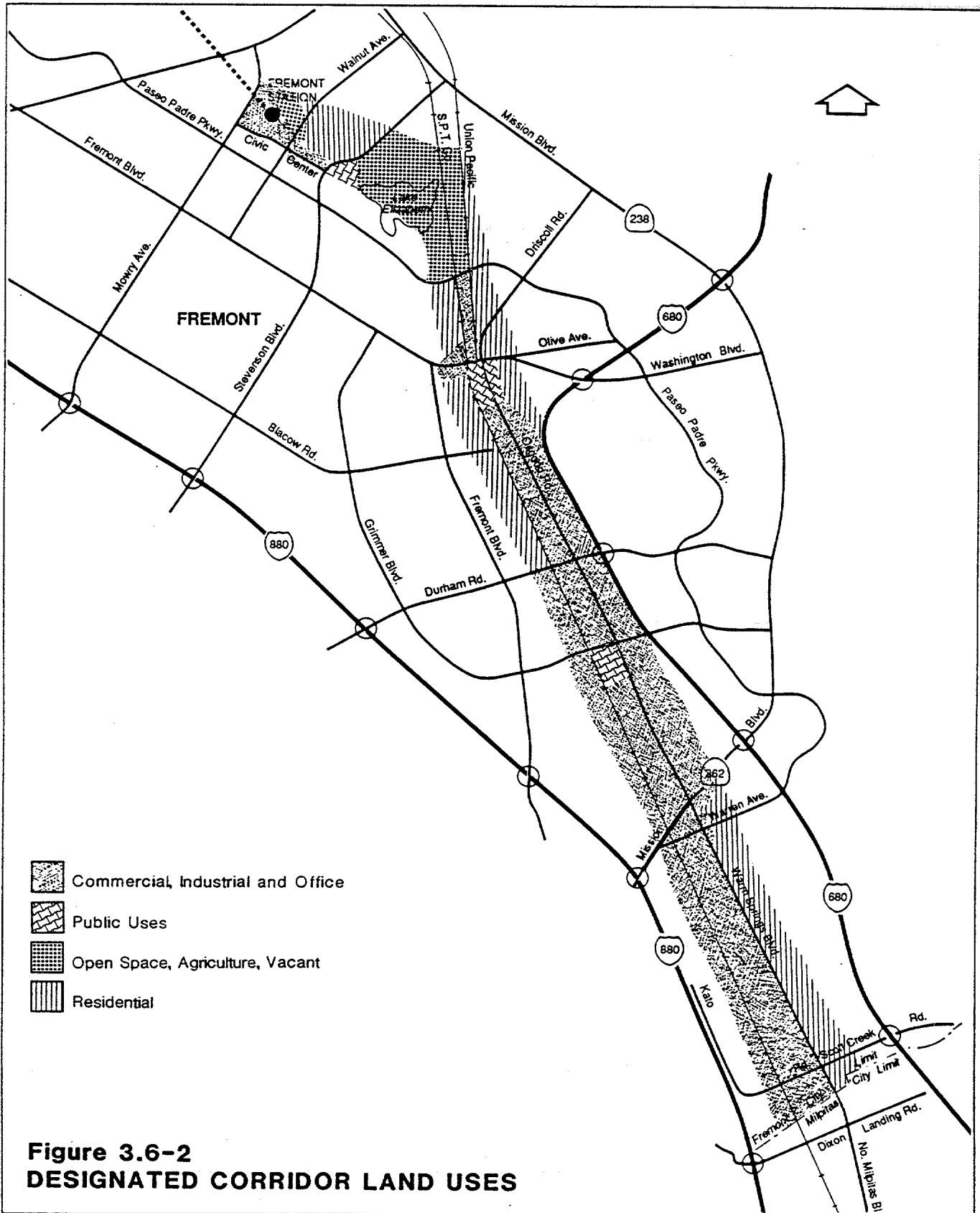
<sup>1</sup>The employment indicator represents the total number of jobs in the area, some of which are held by local residents and the remainder of which are held by workers living outside of the area.

1980 numbers are actual values. 1990-2005 estimates are for April of each year.

Note: The numbers shown in this table may differ slightly from those shown in Table 3.6-1 due to differences in estimating techniques between the Association of Bay Area Governments and Urban Decision Systems, Inc.

Source: Association of Bay Area Governments, *Projections '90*





**Figure 3.6-2  
DESIGNATED CORRIDOR LAND USES**

SOURCE: Recht Hausrath and Associates, 1991

### 3.6 Land Use and Economic Activity

South of Central Park, the Proposed Project crosses into the common rights-of-way of the Union Pacific (UPRR) and Southern Pacific Transportation Company (SPTCo). Though the ROW itself is vacant, the areas on either side are predominantly residential, with a cluster of commercial and industrial parcels centered around the intersection of the railroad ROW and Washington Boulevard. This is also the point where Alternative 8 leaves the railroad ROW and continues in the median of Osgood Road.

South of Washington Boulevard, residential areas are on the west side of the alignment to as far south as Durham Road. East of the alignment, and along Osgood Road, the area takes on an industrial character. A few houses are interspersed with the industrial activities between Washington Boulevard and Blacow Road. Farther south, the alignment is adjacent to industrial developments and large tracts of vacant land. As the alignment approaches Mission Boulevard, to the west is the NUMMI automobile plant, along with some vacant parcels. Land to the east of Warm Springs Boulevard is largely vacant, with a concentration of commercial uses.

As the alignment moves south (between Warm Springs Boulevard and I-880) to the county line, the surrounding area has a mix of newer, large-scale developments. These developments are used for office, scientific research, light manufacturing and warehouse/distribution activities. The area is largely built-out, although several large vacant parcels remain. East of Warm Springs Boulevard, the area is residential with some neighborhood retail establishments. Near Mission Boulevard there is a concentration of multifamily residential complexes. Most of the residential area between Warm Springs Boulevard and I-680 consists of single family homes.

The land use designations in the Fremont General Plan are generally consistent with the existing land uses along the Proposed Project corridor. The downtown area carries a CBD designation, the nearby residential areas are designated for multifamily use, and Central Park and the Civic Center are designated as institutional open space, classified for public use. The area between the railroad tracks is zoned industrial, even though it is undeveloped. The nearby neighborhoods carry residential designations which in many cases permit a higher density than that which currently exists.

South of Washington Boulevard, the area east of the railroad ROW and along Osgood Road is designated for light industrial uses. Between Durham Road and Mission Boulevard the land use designation is entirely industrial, with the area east of Osgood Road/Warm Springs Boulevard subject to certain design and use restrictions. Around the intersection of Mission and Warm Springs Boulevards, the shopping areas are designated community commercial. Land

### 3.6 Land Use and Economic Activity

use designations south of Mission Boulevard indicate residential use to the east of Warm Springs Boulevard, and restricted industrial use to the west.

For the most part, the General Plan's land use designations are consistent with previous land use designations, with a few exceptions. For example, a CBD designation has been applied to the commercial parcels west of the BART station to encourage intensive development in downtown Fremont. Other changes involve individual parcels which had been zoned in a manner inconsistent with the surrounding area; for example, agricultural use parcels along Osgood Road have been redesignated for industrial uses in recognition of development trends in the area. In anticipation of the extension of BART, the proposed sites for the Irvington and Warm Springs stations have been designated for public uses. The South Warm Springs Station is still designated for industrial use.

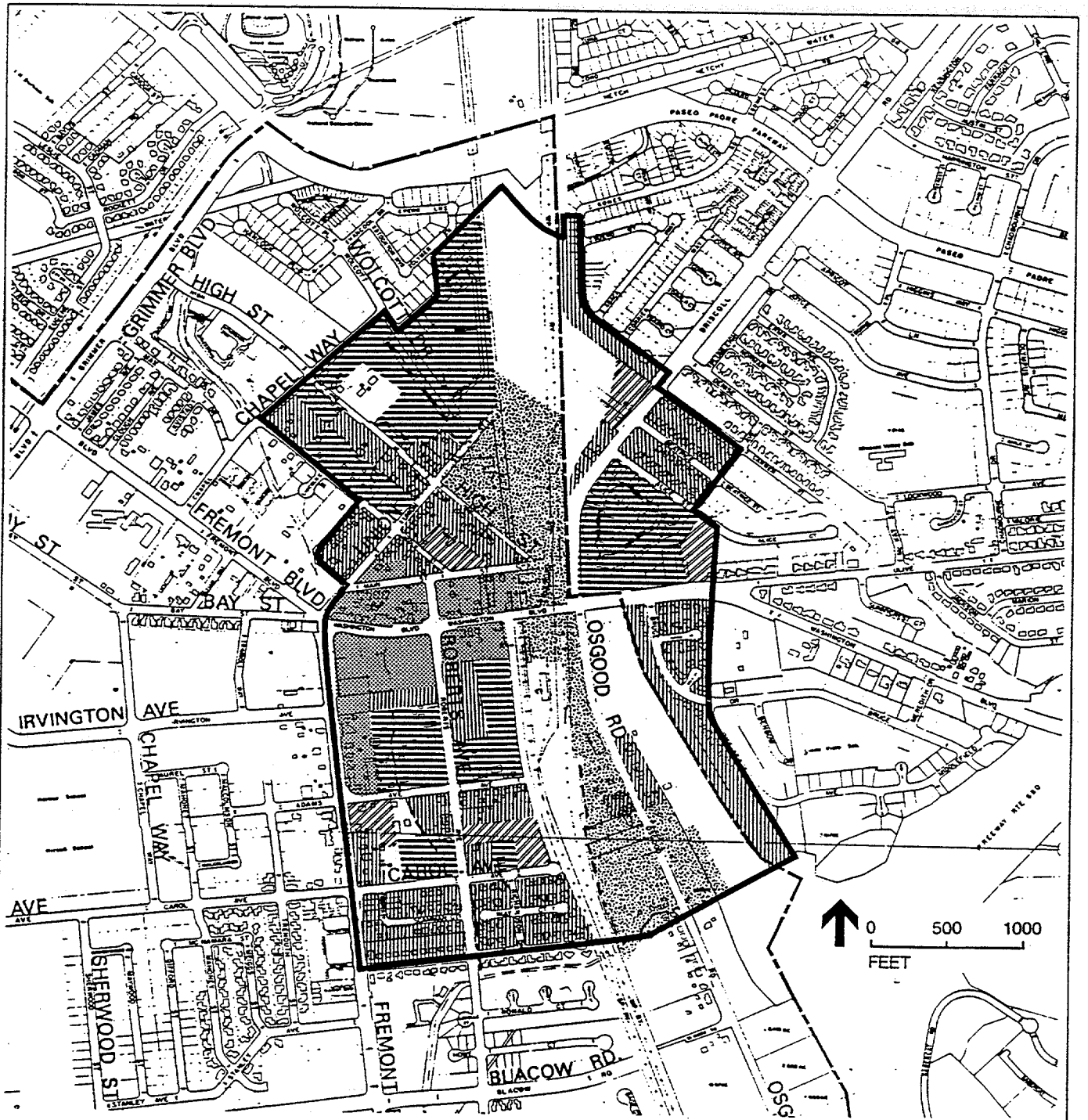
**Irvington Station.** The Irvington Station would be located in the railroad ROW immediately south of Washington Boulevard. Figures 3.6-3 and 3.6-4 show current and designated land uses surrounding the proposed Irvington Station site.

The station site is in the midst of residential neighborhoods; however, a concentration of service/industrial uses exists along Washington Boulevard and the railroad ROW. The development fronting Osgood Road to the south includes older houses, some of which have been converted to commercial uses such as automotive repair. Recent infill development has consisted of the construction of commercial and light industrial space.







Retail and commercial uses are concentrated along Washington Boulevard west of the proposed station. North of Washington Boulevard are older buildings that have a minimal setback from the street. This area has a mix of residential and commercial activities. A newer community shopping center is located south of Washington Boulevard.

Beyond the commercial and industrial areas along Washington Boulevard and the railroad ROW, most of the uses surrounding the proposed Irvington Station are residential. East of Osgood Road are the adjoining neighborhoods of the Mission San Jose Planning Area, with a steep slope separating the neighborhoods from the Irvington District.

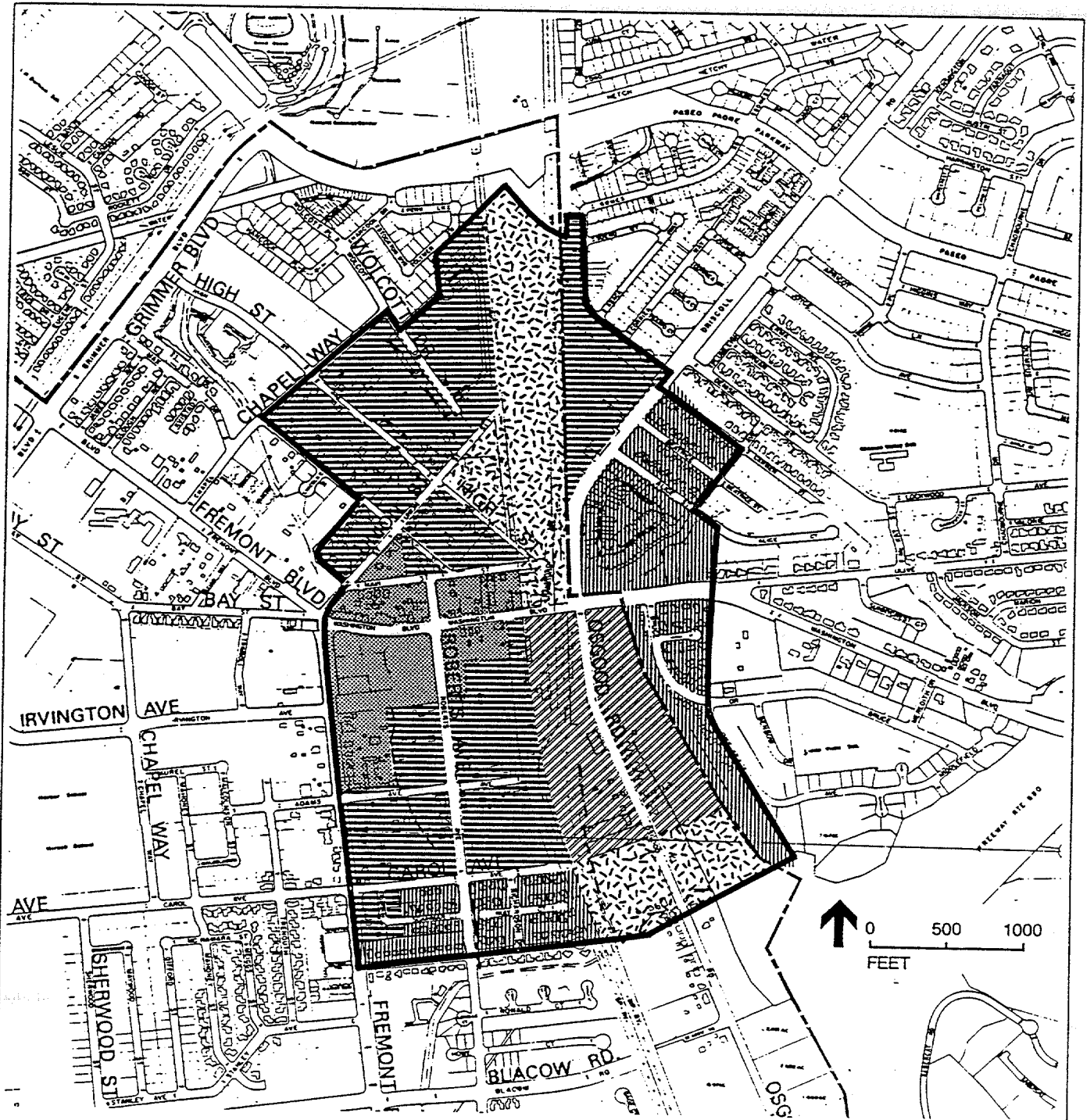
The General Plan's land use designations for the Irvington Station area largely reflect existing patterns, as well as those the City wishes to encourage. Parcels between the railroad ROW and Osgood Road, south of Washington Boulevard, are zoned for light industrial uses. The blocks fronting Washington Boulevard are designated for community commercial, which generally








**Figure 3.6-3**  
**EXISTING LAND USE**  
**Irvington Station**  
**and Surrounding Areas**

- |   |                           |   |                     |
|---|---------------------------|---|---------------------|
|  | Single Family Residential |  | Undeveloped         |
|  | Multi Family Residential  |  | Public/Quasi Public |
|  | Commercial                |  | Industrial          |

SOURCE: Recht Hausrath and Associates, 1991



**Figure 3.6-4**  
**DESIGNATED LAND USE**  
**Irvington Station**  
**and Surrounding Areas**

- |   |                         |   |                       |
|---|-------------------------|---|-----------------------|
|  | Low Density Residential |  | Restricted Industrial |
|  | Medium/High Residential |  | Commercial            |
|  | Public Uses             |   |                       |

SOURCE: Recht Hausrath and Associates, 1991



implies retail and service activities as well as compatible commercial uses. The neighborhoods are designated for medium to high density residential use. The parcels proposed for the BART station are identified for public use.

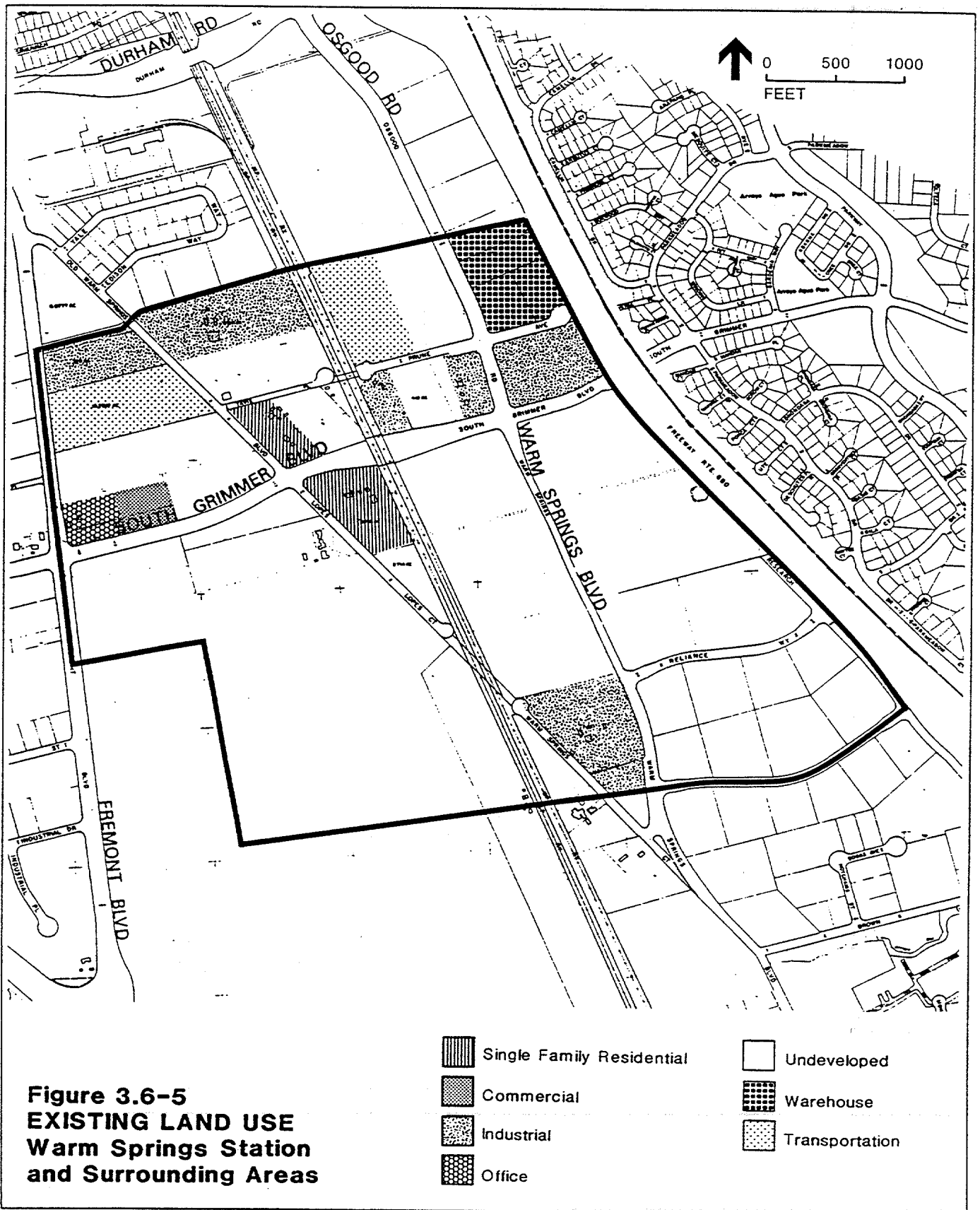
**Warm Springs Station.** The proposed Warm Springs Station would be adjacent to South Grimmer Boulevard, near the intersection of Osgood Road/Warm Springs Boulevard. (Figures 3.6-5 and 3.6-6 show current and designated land uses in the station area.) The station area includes both industrial and undeveloped parcels. The land to the east and west of the station site is presently undeveloped. Agricultural cultivation continues on the parcel southeast of the intersection of South Grimmer and Warm Springs Boulevards. Other, large undeveloped parcels are located north of South Grimmer Boulevard.

Several types of developed land uses are present in the proposed station area. A light industrial complex is located immediately to the south of the proposed station site, and other concentrations of industrial and warehouse uses are also found to the north of South Grimmer Boulevard. The NUMMI automobile manufacturing plant is located west of the proposed station, but outside of easy walking distance. Other uses in the station area include warehouses, office and commercial buildings, and equipment yards. There are also individual residences on the north and south sides of South Grimmer Boulevard.

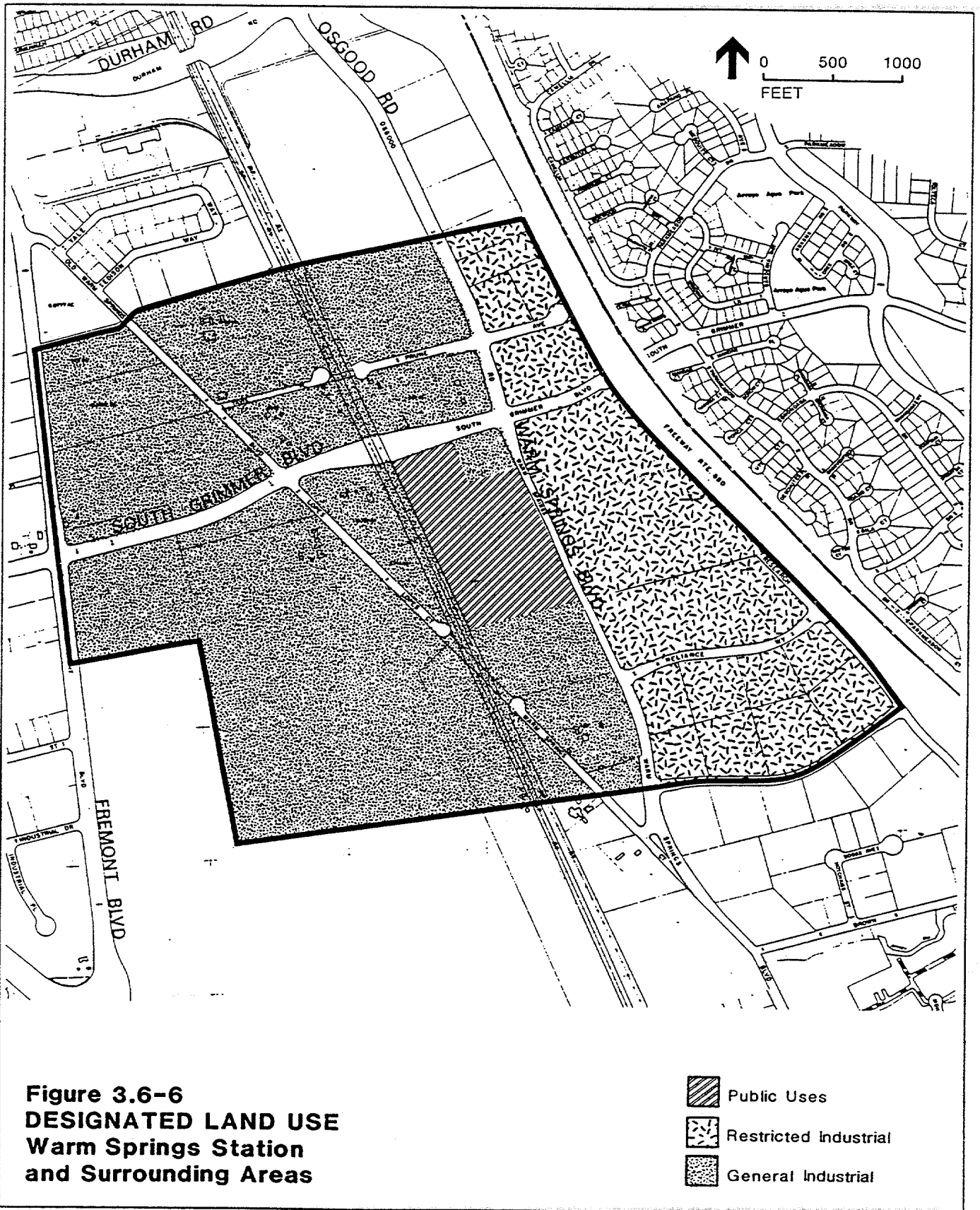
The General Plan designates the area around the Warm Springs Station area as industrial use. East of Osgood Road and Warm Springs Boulevard the City is restricting heavy industrial uses which involve significant nuisances or hazards. The remainder of the industrial areas west of Warm Springs Boulevard and Osgood Road are designated as general industrial, the City's most inclusive land use category. The parcel proposed for the station site is owned by BART. In anticipation of the BART extension, the City has designated this parcel for public uses.

**South Warm Springs Station.** The proposed site of this station is between Warm Springs Boulevard and I-880, near the county line. (Figures 3.6-7 and 3.6-8 show current and designated land uses.) Land uses in the station area are uniform; residential uses are east of Warm Springs Boulevard, and industrial uses are located to the west.

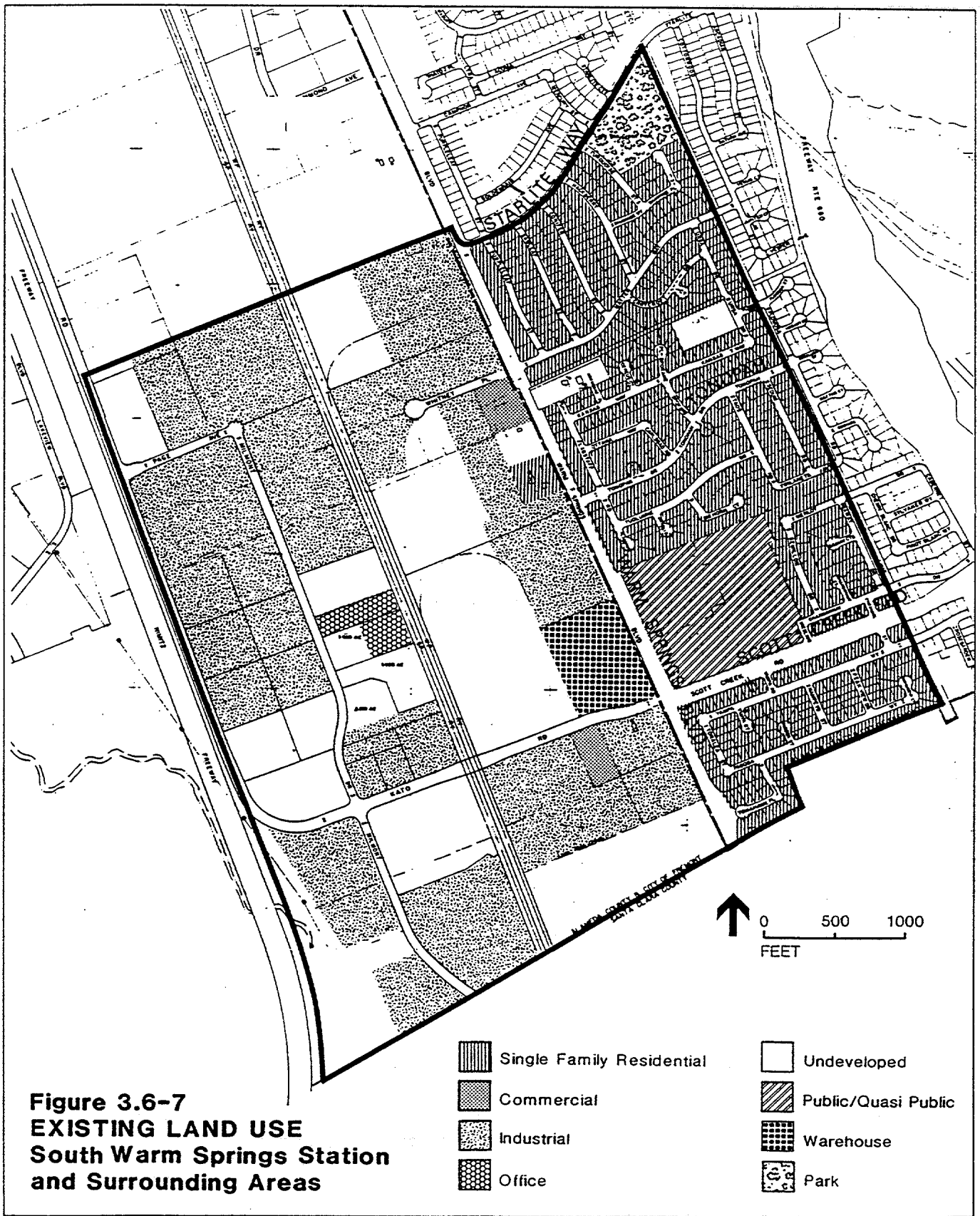
The industrial areas have experienced a considerable amount of development activity in recent years. The majority of the area is now developed, although a few large sites still remain along Kato Road and Milmont Drive. Developments reflect a mix of uses, accommodating office, research and development, and light manufacturing activities. Many high technology firms are



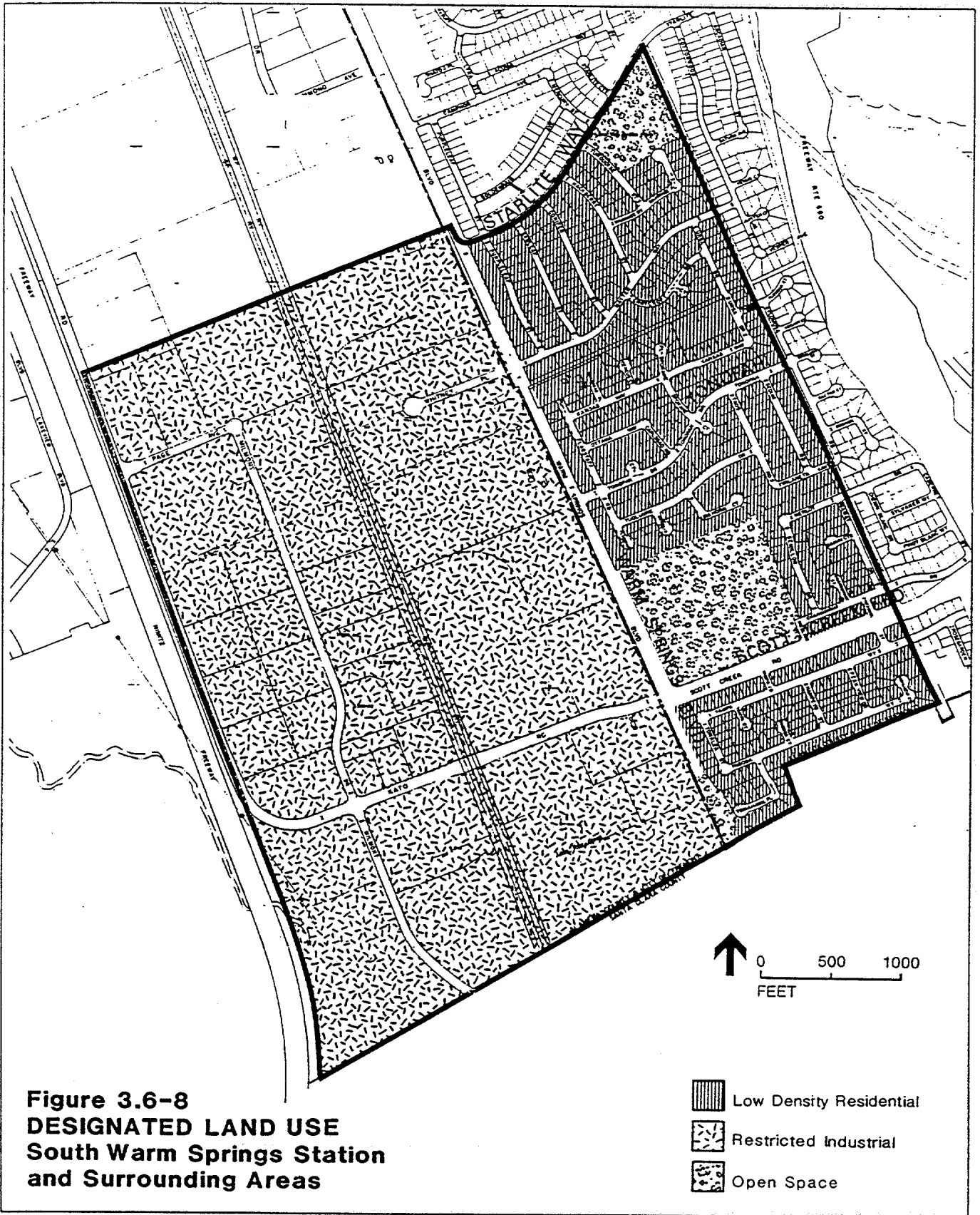
SOURCE: Recht Hausrath and Associates, 1991



SOURCE: Recht Hausrath and Associates, 1991



SOURCE: Recht Hausrath and Associates, 1991



SOURCE: Recht Hausrath and Associates, 1991

### 3.6 Land Use and Economic Activity

concentrated along Milmont Drive (north of Kato Road) and along the section of Kato Road fronting I-880. Although such firms are also located south of Kato Road, that area is mostly occupied by general industrial uses, such as warehouse facilities and automotive-related establishments. Fronting the south side of Warm Springs Boulevard are recently constructed industrial buildings, with a single residence located south of Whitney Place. A vacant warehouse building is located at the northwest corner of Kato Road and Warm Springs Boulevard.

The area east of Warm Springs Boulevard is entirely single family residential with a few undeveloped parcels. The residences fronting Warm Springs Boulevard face eastward and are separated from the industries to the west by a continuous, common high fence. The only non-residential use east of Warm Springs Boulevard is the Lima Family Mortuary located on the northeast corner of Warm Springs Boulevard and Kato Road.

The General Plan designates the area west of Warm Springs Boulevard for restricted industrial uses, and the area east of Warm Springs Boulevard for low density residential uses. The cemetery is open space. The designations are generally consistent with those under the prior general plan. The old zoning, however, permitted general industrial in the area between Warm Springs Boulevard, and the railroad ROW. It also showed an agricultural designation for the parcel adjacent to the county line, west of Warm Springs Boulevard.

#### **Potential for Growth**

Cities have a great deal of influence over future development. Local growth policies, including zoning regulations, public facility fees, density limits, and the willingness (or ability) to expand infrastructure and public facilities, can affect the potential for local growth.

Fremont has historically favored growth, but the City now favors growth management policies. These policies emphasize such factors as the desirability of a particular industry from a fiscal perspective, and the design quality of new structures. Fremont's General Plan contains numerous policies designed to accommodate continued residential, commercial, and industrial developments. The City has expressed interest in having higher density development around BART stations. This is shown by the new development adjacent to the existing downtown Fremont BART Station. Within one-half mile of the station, where many existing buildings are either high-rise office or multifamily residential, higher floor area ratios (FAR's) are allowed. Similarly, the City has proposed that land use designations around the proposed Irvington Station area be reviewed.

### 3.6 Land Use and Economic Activity

In Fremont, there is a large supply of non-residential land projected to accommodate industrial development for the next 20 to 25 years. Fremont is one of the few areas in Alameda County with sufficient land supply to support continued development of warehouse space. The supply of residential land is much more limited. The City favors expediting the development process by streamlining the review and approval process and by providing services and facilities in a timely fashion to new development. There are no obstacles to extending infrastructure and services, with adequate facilities to accommodate growth; localized improvements may be necessary in specific areas.

Current projections in the General Plan indicate that the supply of industrial land to the year 2010 will be in excess of residential land. Residential areas in Fremont will be largely built out by the year 2010. There are several options that the City can take to increase the supply of residential land. One would be to rezone industrial land to residential use. This is being assessed in two special study areas in the Industrial Planning Area: Warm Springs BART Study Area and Fremont Shores Study Area. In its discussions of rezoning industrial land, the City is concerned that an adequate supply of industrial land be maintained to meet the City's employment goals, and that residential uses be compatible with adjacent industrial uses. (Proposed, large residential developments on industrial land are discussed in more detail below.) A second option for residential development would be to construct housing on sites previously passed over. A third option is for greater land utilization via high density development, particularly in Central Fremont. A fourth option, hillside residential development, is a sensitive issue, since the City favors an "open space frame," which highlights the undeveloped character of the hills to the east.

#### **Real Estate Development Trends**

The real estate market in southern Alameda County is more similar to neighboring communities in Santa Clara County than to the older cities in northern and central Alameda County. This is largely due to the recent growth of high-technology businesses in southern Alameda County. In fact, Fremont and Newark are the only cities in Alameda County undergoing major manufacturing and wholesale job growth.

### 3.6 Land Use and Economic Activity

The industrial sector of the southern Alameda County real estate market is both stronger and larger than the office sector.<sup>1</sup> Table 3.6-5 provides detailed information on the amount of existing, newly constructed, vacant, and recently absorbed commercial and industrial space in Fremont for the years 1986, 1988 and 1990. In 1985-86 there was a severe oversupply of office and industrial space in many of the submarkets within southern Alameda County and Santa Clara County. High vacancy rates led to reductions in effective rents, and a slowdown in construction of new office and industrial properties. At present, the focus is on marketing existing space. Vacancy rates have been steadily declining since 1987, but new construction activity remains slow. In the long run, employment expansion in the Silicon Valley area (and in southern Alameda County) should absorb existing space and create demand for new construction.

Rents for industrial land in Fremont are lower than in other areas in the Silicon Valley, which makes Fremont very competitive. (Over a recent four-year period, industrial land prices in Fremont have been among the lowest in the Silicon Valley.<sup>2</sup>) The supply of industrial space in 1990 represents a 56 percent increase over 1986. Vacancies are high (22 percent), but are less than they were in 1986 (42 percent).

The office market in Fremont tends to serve primarily local businesses. Buildings are often smaller scale (less than 100,000 square feet). Office buildings compete with R&D parks, which can be used for light industrial or office uses. At this time, there is little new construction of office space. However, vacancies in office space have declined considerably.<sup>3</sup>

Over the last few years, there have been several new office projects in the CBD. For example, the newly constructed Fremont Office Center (90,000 sq. ft.) and the Leighton Business Center (72,000 sq.ft.) are both located near the Fremont BART Station, with other projects planned for the area. Kaiser Permanente is in the process of a major expansion of its medical facilities. Ongoing development of high-density residential and office buildings is planned for other vacant parcels near the Fremont BART Station.

---

<sup>1</sup> "Southern Alameda County - Market Focus," *Northern California Real Estate Journal*, April 18, 1988.

<sup>2</sup> Grubb & Ellis, "Industrial Land Prices," 1991.

<sup>3</sup> Although office space reported in Table 3.6-5 shows a decline in existing inventory between 1986 and 1988, according to Chris Frye of Grubb & Ellis, this discrepancy is due to the way in which the information is gathered and not due to demolition of office space.



**Table 3.6-5  
Summary of Office and Industrial Space:  
Supply and Absorption  
City of Fremont<sup>1</sup>**

	<u>Office Space (Square Feet)</u>			<u>Industrial Space (Square Feet)</u>		
	Dec. 1986	Dec. 1988	Dec. 1990	Dec. 1986	Dec. 1988	Dec. 1990
Existing	1,596,185	1,226,918	1,423,706	9,927,796	12,179,333	15,480,122
Under Construction/ New Construction Completed	196,600	90,423	0	617,587	774,850	596,860
Vacant	414,609	367,210	235,227	4,197,161	3,009,703	3,416,809
Vacancy Rate	26%	30%	17%	42%	25%	22.1%
Gross Absorption <sup>2</sup>	259,944	287,642	401,375	1,479,975	2,079,686	3,083,552
Net Absorption	194,606	150,208	59,771	1,238,035	985,874	900,812

<sup>1</sup> Office space in speculative buildings of 25,000 square feet or more and industrial space in speculative buildings of 5,000 square feet or more. Office space inventory for 1990 covers buildings of 20,000 square feet or more. Only vacancies in existing space are included.

<sup>2</sup> Gross absorption is a measure of total space newly leased during the course of a year. Net absorption is defined as the difference between the amount of space occupied in one year and the amount occupied in the previous year, thus accounting for changes in the occupancy of previously existing space.

Source: Grubb & Ellis, Commercial Brokerage Services, San Jose, California, 1987, 1989, and 1991.

### 3.6 Land Use and Economic Activity

Retail activity in Fremont is not as strong as in some of the other cities in southern Alameda County. There is no major regional mall, and Fremont has experienced some retail leakage to surrounding communities such as Newark and Hayward. Fremont Gateway Plaza (formerly the Fashion Center) located near the Fremont BART Station, had experienced high vacancies and is undergoing significant redevelopment. The redevelopment of the center consists of several new developments or renovations, including as a supermarket, restaurants, an eight-theater movie complex, and a five-story office/medical building.<sup>1</sup>

One potential development area is a 700-acre tract located west of Highway 880 at Durham Road, on industrially zoned land owned by Catellus. An 88-acre regional auto mall has been approved for this area, and construction has already started. Improvements to Durham Auto Mall Parkway are almost completed. Catellus has requested a General Plan amendment, changing the area from industrial to mixed use designation. This would accomodate current development plans including a golf course, 1500 dwelling units, parks, an elementary school, open space and wetlands. There would be at least one commercial center which would serve both the neighborhood and industrial area. Finally, there would be industrial development, primarily R&D, that could be used for high tech or office uses.<sup>2</sup>

In another case, the City postponed consideration of a General Plan amendment request by Shapell Industries to rezone 74 acres of industrial land to residential and retail/commercial in favor of evaluating an expanded area of approximately 170 acres adjacent to the proposed BART Warm Springs Station. The Warm Springs BART Area Specific Plan covers an area generally bounded by South Grimmer Boulevard, I-680, Mission Boulevard/Brown Road and the railroad corridor. Although Shapell has withdrawn its request, this area is still being assessed to determine whether a viable residential community can be created.<sup>3</sup> A major constraint would be the nearby NUMMI plant, which has expressed concern that residential land use would be incompatible with the operation of an automobile manufacturing plant.

---

<sup>1</sup> Roger Shanks, 1991 Planning Department, City of Fremont, telephone interview, March 28.

<sup>2</sup> Roger Shanks, 1991.

<sup>3</sup> Information on the Warm Springs BART Area Specific Plan status was obtained from Mary Prisco, City of Fremont, March 21, 1991.

### Retail Sales

Retail sales, a frequent measure of economic conditions, are significant since sales occurring in the study area contribute to the sales tax revenue base. Table 3.6-6 presents information on taxable sales in Alameda County and Fremont for the years 1979 and 1989, and calculates the percentage change between the two periods in real dollars.

Taxable sales in Alameda County grew by almost 15 percent between 1979 and 1989, and by 46 percent in Fremont. The higher growth rate in taxable sales in Fremont during this same period may be partly explained by recent residential and light industrial development, which resulted in increased retail activity.

**Table 3.6-6**  
**Taxable Sales for Alameda County and Fremont**  
**1979-1989 (In Thousands of Nominal Dollars)**

	Alameda County		Fremont	
	1979	1989	1979	1989
Retail Stores	\$3,781,271	\$ 7,762,787	\$405,645	\$ 892,415
All Other Outlets	2,319,708	4,882,091	112,328	479,718
Total All Outlets	\$6,100,979	\$12,644,878	\$517,973	\$1,372,133
1979-1989 Percent Change <sup>1</sup>	14.5%		46.3%	

<sup>1</sup> Percentage change in real dollars after converting to 1967 base year using San Francisco-Oakland CPI data (1989 = 3.885 and 1979 = 2.146).

Source: California Board of Equalization, *Taxable Sales in California, Annual Report*, 1979 and 1989.

### Municipal Revenues and Expenditures

Table 3.6-7 provides information on general municipal financing for Alameda County and Fremont. Fremont has a tax base that is relatively high compared to more rural areas, or older urban areas that are more economically depressed. Differences between Alameda County and

**Table 3.6-7**  
**General Financing, Fiscal Year 1988-89**  
**Alameda County and Fremont**

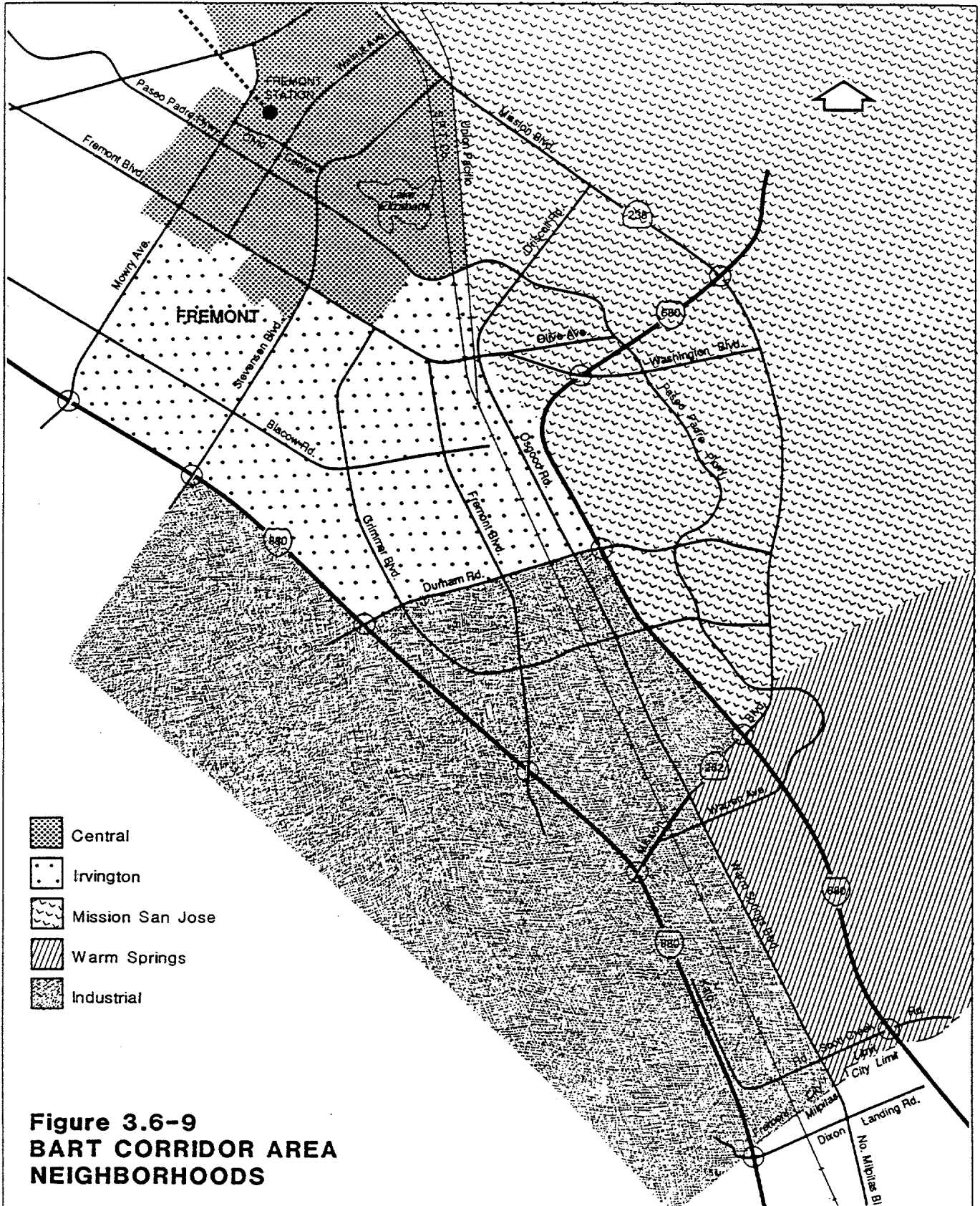
	Alameda County	Fremont
Total Revenues	\$786,970,831	\$73,396,865
- All Taxes	28.2%	65.0%
- Intergov't Grants & Transfers	58.6%	15.3%
- License & Service Charges	6.3%	9.1%
- Other	6.9%	10.6%
Revenues per Capita	\$628	\$434
Total Expenditures	\$788,811,905	\$66,308,932
- General Government	11.2%	14.9%
- Public Safety	25.9%	44.8%
- Trans. & Pub. Util.	2.5%	11.3%
- Other (Incl. Health, Schools, Community Dev., Culture, etc.)	60.4%	29.0%
Expenditures per Capita	\$630	\$392

Source: California Office of the Controller, Counties of California Financial Transactions Annual Report, 1988-89, and Financial Transactions Concerning Cities of California, 1988-89.

Fremont in their revenue and expenditure patterns can be explained by general trends in municipal financing. Counties are more reliant on intergovernmental grants and transfers than are cities, which rely more on license and service charges for operating revenues. Additionally, cities spend more on infrastructure, such as transportation and public utilities, and public safety, whereas counties emphasize public services, such as health and welfare.

### Neighborhood Characteristics

Figure 3.6-9 shows the Central Fremont, Irvington, Mission San Jose, Warm Springs, and Industrial planning areas. These five planning areas of Fremont could potentially be affected



**Figure 3.6-9  
BART CORRIDOR AREA  
NEIGHBORHOODS**

SOURCE: Recht Hausrath and Associates, 1991

by the BART extension. Central Fremont is the center of business and government activities in Fremont. The Irvington, Mission San Jose and Warm Springs planning areas are predominantly residential, but each has a distinctive character. The Industrial Planning Area is one of the few areas of large undeveloped tracts of land in the South Bay, and is presently the site of major non-residential developments.

**The Central Planning Area.** The Central Planning Area is the focus for business and local government activities. The highest density development in Fremont are found in the Central area, where the City has encourage high density office and multi-family residential projects to take full advantage of the proximity of the existing Fremont BART Station. The Central area also includes the Civic Center complex, the recently opened main library, and Fremont Central Park. The location of these three major community facilities within the same area creates a civic focus for Fremont.

*Socioeconomic statistics presented for each of the planning areas have been taken from two principal sources. Information on residents, households, employed residents, age and income characteristics for 1990 are taken from Projections '90, published by ABAG. The ABAG estimates were obtained at the census tract level, and have been aggregated to correspond to the City of Fremont Planning Areas. The second source for descriptive statistics is the 1990 U.S. Census (preliminary count) which provided information on race and ethnic origin. The Census information has also been aggregated for the census tracts comprising the planning areas. This discussion has been augmented by field surveys of the neighborhood areas and information presented in the General Plan.*

Concentrations of single family and multifamily housing are located within the Central area. The major single family areas are located toward the outer boundaries of the area east of Mowry Avenue, west of Mission Boulevard, along Paseo Padre Parkway, and in the section of the Central Area located east of Central Park. Recent multifamily projects in and around the CBD include those located between Walnut Avenue and Stevenson Boulevard south of Gallaudet Drive. These developments are within walking distance of the BART Station and represent successful attraction of high density development near a transit station. Multifamily development activity is also taking place in the southwest areas of the Central Planning Area in the vicinity of Stevenson and Fremont Boulevards.

In 1990, the Central Planning Area was estimated to contain 22,600 persons, or 13 percent of the City's total population. (See Table 3.6-8.) Residents of the area are more likely to be members of a minority group; seven percent of the residents are Black, 16 percent are Asian; 16 percent also identified themselves as Hispanic. Average household size is estimated at 2.4 persons per household, compared to approximately 2.9 persons per household citywide. The

**Table 3.6-8**  
**Planning Area Population and Household Characteristics, 1990**  
**Selected Areas and City of Fremont**

Planning Area <sup>1</sup>	Total Population	Employed Residents	Households	Average Household Income
Central	22,600	14,128	9,478	\$40,049
Irvington	39,035	21,398	12,793	44,759
Mission San Jose	28,122	16,469	9,064	64,611
Warm Springs	11,499	6,430	3,736	66,101
Fremont Sphere of Influence	175,200	97,300	61,190	49,300

<sup>1</sup>Information specific to the Industrial Planning Area is not available.

Source: Association of Bay Area Governments, *Projections '90*.

average household income is lower than the citywide average. When employment, income, age, and household size information from the Central Planning Area is compared to citywide data, the trends which emerge indicate that Central Area residents are younger, working people.

**The Irvington Planning Area.** The Irvington planning area includes Central Irvington and surrounding neighborhoods. Central Irvington is built around a historic commercial area that runs along Washington and Fremont Boulevards. It includes several buildings dating to the turn of the century, and exhibits land use patterns reminiscent of its days as an unincorporated community. A redevelopment area was created in the late 1970s and includes much of the old downtown area of Irvington. The available tax increment financing is being used to upgrade Fremont and Washington Boulevards to accommodate the volume of traffic passing through Irvington.

Parcels fronting Osgood Road were developed over fifty years ago, and are now undergoing redevelopment. There are still two-lane sections of Osgood Road that are fronted by structures that were built prior to Irvington's annexation into the City of Fremont. Commercial buildings

### 3.6 Land Use and Economic Activity

are interspersed with residences. Many of these older homes have been converted to commercial uses.

Aside from the commercial uses fronting the major thoroughfares, Central Irvington is predominantly residential. Most of the neighborhoods consist of single family homes, though some multifamily housing has been developed around the commercial district. In particular, a multifamily housing complex was recently developed on a large tract of land adjacent to the railroad corridor between Washington Boulevard and Paseo Padre Parkway.

The Irvington Planning Area also includes the neighborhoods extending to I-880 to the west and Mowry Avenue to the north. These areas are predominantly single family, and most of the development has taken place since the 1960s. The development patterns in Irvington typically include multifamily complexes along major thoroughfares, with neighborhood retail stores at major intersections. The Southlake mobile home park is located in the south portion of Irvington along Durham Road, between Fremont and South Grimmer Boulevards.

The 39,035 residents in Irvington comprise 22 percent of Fremont's total inhabitants. Racial composition in 1990 was mostly white with about 3 percent Black and 10 percent Asian. Approximately 18 percent of the total population was Hispanic. Irvington exhibits a similar resident age pattern as the City as a whole, with a slightly higher percentage of children under five. The percentage of residents employed is about 55 percent, slightly lower than citywide levels, and average household income is slightly lower than the citywide average.

**The Mission San Jose Planning Area.** The Mission San Jose planning area is east of the Irvington and the Central planning areas. Mission San Jose is mostly residential, with nonresidential uses limited to neighborhood retail centers. Although the proposed BART alignment runs through only a small segment of this planning area, there is a residential area near Central Park (Valdez Way and Valero) which is located adjacent to the alignment.

Neighborhoods to the north of I-680 are largely composed of single family homes with a few condominium and apartment complexes. The topography is flat with the hillside rising just to the east of Mission Boulevard. Single family residential construction is presently taking place in the foothill area immediately adjacent to Mission Boulevard, but otherwise, this area of Mission San Jose is almost entirely built out.

Mission San Jose has a population of 28,122, about 16 percent of the city total. The racial composition of the area is 24 percent Asian, 71 percent white, and 5 percent other groups.



### 3.6 Land Use and Economic Activity

Approximately 7 percent of the total population is also identified as Hispanic. Age distribution differs from that of the city as a whole; a higher percentage of the population was estimated to be in the 45 to 64 age group in 1990. Average household income is significantly above the citywide average.

**The Warm Springs Planning Area.** The Warm Springs planning area is the southernmost planning area with significant residential development. Neighborhood commercial development is located along Mission Boulevard at the north edge of Warm Springs. Most of Warm Springs west of I-880 is single family residential, including the majority of the properties fronting Warm Springs Boulevard. Neighborhood commercial establishments serving Warm Springs are concentrated along Mission Boulevard west of I-680. The neighborhood in the vicinity of Warren Avenue includes several multifamily complexes.

The Warm Springs Planning Area contains the 7 percent of the City's population. 1990 census data indicate that the population is primarily white, although 23 percent of the population is Asian and 2.5 percent Black. Almost 10 percent of the total population is also identified as Hispanic.

In terms of income, the areas east and west of the freeway should be considered as separate subareas. The area east of I-680 contains expensive custom homes, and residents living there had an estimated average household income of \$113,700 in 1990.<sup>1</sup> The area west of I-680, closer to the proposed BART alignment, is more typical of the rest of Fremont. Households located there had an estimated average household income of \$51,500 in 1990.<sup>2</sup> Age composition of the combined areas is not significantly different from the City as a whole.

**The Industrial Planning Area.** The industrial planning area is almost entirely industrial. It covers the majority of the area south of Durham Road and west of I-680, with the exception of a small segment which is located in the Warm Springs Planning Area. The General Plan designates the Industrial area to be the focus of most of Fremont's economic growth in the next ten to twenty years. Well-served by both highway and rail transportation systems, the area contains some of the largest undeveloped tracts of land available in the South Bay. In addition to the opening of the NUMMI plant, the area has experienced considerable growth in industrial, research and development, and office projects in recent years. The majority of the sites in the

---

<sup>1</sup> Information is for census tract #4432.

<sup>2</sup> Information is for census tract #4433.

### 3.6 Land Use and Economic Activity

vicinity of the Proposed Project's alignment are of an industrial character, and include developed as well as undeveloped sites. A concentration of commercial uses is also found around the intersection of Mission and Warm Springs Boulevard.

The only residential concentration in the Industrial Planning Area is an apartment complex north of Mission Boulevard which is surrounded by commercial and industrial land uses. If this complex were to be associated with a neighborhood, it would be more similar to the multifamily section of the Warm Springs Planning Area located on the other side of Mission Boulevard. In addition, there are a few isolated single family residences within the Industrial Planning Area. These appear to date back to the time when the land was primarily in agriculture use. Current demographic information for the limited number of inhabitants in the Industrial Planning area is not available.

**Neighborhood Planning Goals.** Fremont's goals for neighborhood planning are described in the General Plan. It is the City's policy to encourage high density development and promote a pedestrian-oriented environment within a one-half mile of the existing Fremont BART Station. The CBD land use designations applied to the core area permit a wide range of uses including office, regional retail, service, and medical buildings, entertainment and cultural facilities, and eating and drinking establishments. Although the General Plan prohibits wholly residential projects in the CBD, it does foresee future approval of commercial and residential mixed-use development. Land uses with an automobile orientation are considered inappropriate for the CBD. As the CBD continues to develop, future projects will be approved on the basis of their contribution to the pedestrian environment, and to the intensity of activity in the core area.

The City has also designated, through the General Plan, specific plan areas to focus on development policy alternatives for defined areas of the City. One such area, the Warm Springs BART Study Area, is located near the proposed Warm Springs Station between Warm Springs Boulevard and I-680 in the Industrial Planning Area. Although this area is designated for industrial land uses, it has been proposed for redesignation to accommodate future residential development. A study commissioned by the City concluded that residential development was feasible, given market conditions and the proximity of the proposed BART station; however, due to the industrial character of the surrounding area, there are major concerns about land use conflicts and measures required to mitigate potential nuisances and hazards. Based on the recommendations of the study, the area east of the proposed Warm Springs Station has been

designated for further study under an area specific plan. No conclusions about redesignation have been reached.<sup>1</sup>

Downtown Irvington has also been the subject of specific area planning efforts. A redevelopment area has been formed around the old commercial district to permit the use of tax increment financing for local public improvements. The design and layout of Old Irvington dates to the early part of the century, but the demands of growth have required improvements to streets and intersections in Irvington to accommodate increased traffic flows. However, the City endeavors to retain Irvington's historic character.

The development of a BART station in Irvington is very important to the redevelopment potential of this area. To this end, the Irvington BART Station Concept Plan was created and adopted in March 1990.<sup>2</sup> The plan addresses issues of land use, urban design, site design and circulation associated with the development of an Irvington BART Station. It is fairly specific and addresses issues such as parcels available for new development and recommended land uses for them, orientation of the station structure, and circulation for pedestrians and automobiles between the station and the surrounding areas.

### 3.6.2 IMPACTS OF PROPOSED PROJECT AND MITIGATION MEASURES

This section presents seven potential areas of impacts, i.e., population, employment, land use, real estate, municipal revenues, neighborhoods and displacement. It sets forth criteria for assessing significance and assesses whether the Proposed Project would generate significant direct impacts, cumulative impacts, and construction period impacts.<sup>3</sup> Where there are significant impacts, mitigation measures are suggested, and any residual impacts after mitigation are identified.

---

<sup>1</sup> Telephone conversations with Mary Prisco, City of Fremont Planning Department, March 21 and 28, 1991.

<sup>2</sup> This Plan was prepared by a Consultant working for the City of Fremont. BART staff and consultants were included in discussions and meetings pertaining to the Concept Plan. However, the actual Plan referenced here has been formally adopted by the City only.

<sup>3</sup> Criteria for significance are adapted from State CEQA Guidelines and from standards of professional practice.

### **Population**

Significant population impacts could occur from the Proposed Project if it:

- Induces growth or concentration of population
- Alters the location, distribution, density or growth rate of the population
- Conflicts with housing and population projections and policies set forth in the General Plan

On a regional basis, the effect of transit improvements is to redistribute growth.<sup>1</sup> There may be some concentration of population surrounding transit stations. However, this would occur only if there were strong market demands for higher density housing and if local land use policies facilitate such development. The extent to which the population could become concentrated surrounding the existing and proposed BART stations is not significant when compared to the potential for population growth elsewhere in the City. (Also see Chapter 4, Growth-Inducing Impacts.)

There are no obvious conflicts between the housing and population projections in the General Plan and the proposed extension of BART to South Warm Springs. The City of Fremont's land use policies favor higher density residential development adjacent to the existing Fremont BART Station, and lower density residential and non-residential developments are recommended for the areas surrounding the other proposed BART stations. Consequently, it can be concluded that there would be no significant direct, cumulative or construction period population impacts associated with implementation of the Proposed Project.

### **Employment**

Construction and operation of the Proposed Project could generate significant impacts if it created local labor shortages. These labor shortages in the short run could bid up the price of

---

<sup>1</sup> The effect of transit improvements on regional growth (i.e., leading to a redistribution of growth and not to net, new growth in a region) is also cited in: Robert L. Knight and Donald Appleyard, "Environmental Impacts of Transit Systems," in *Public Transportation: Planning, Operations and Management*, edited by George E. Gray and Lester A. Hoel, 1979, p 541.

### 3.6 Land Use and Economic Activity

labor and create problems for other sectors of the local economy. In the long run, there could be an increase in regional population as workers relocate to the San Francisco Bay Area.

Construction and operation employment impacts would be positive on the regional economy, since the construction and operation of the project would create more jobs. For a four-year period in the 1990s, jobs would be generated on a temporary basis to extend BART facilities. On a continuing basis, jobs would also be created to operate the transit facilities once completed. Additionally, there would be a "multiplier effect" or indirect employment impacts, since newly employed workers would consume additional goods and services whose provision would generate additional employment. (Indirect employment effects could also be generated through expenditures on materials during system construction. Since a large percentage of these materials will come from outside the region, this contribution to indirect employment impacts is less important.)

Table 3.6-9 presents direct and indirect employment impacts from both the construction and operation phases of the Proposed Project, and the ten alternatives. Table 3.6-9 includes a range of construction employment impacts for the design options. The direct employment estimates were derived from projections of the labor components of the construction and operating costs for the Proposed Project and the BART build alternatives. The amount of direct construction employment that would be generated is estimated by dividing total labor costs by a construction worker's average annual wage plus fringe benefits. (Since there is no construction associated with the non-BART alternatives, only operating employment impacts are presented in Table 3.6-9 for those alternatives.) The construction employment estimates cover the entire construction period. Thus, the employment impacts presented in Table 3.6-9 would be phased over several years.

In contrast, the operations employment impact estimates are only for a single year of operations. The amount of direct employment generated by operations was based on the number of BART employees obtained from O&M Cost Estimates prepared by Manuel Padron & Associates for the BART Warm Springs Extension EIR.<sup>1</sup>

---

<sup>1</sup> For the purposes of assessing net operating employment impacts of the proposed project and all the alternatives, BART employment levels associated with Alternative 3 (TSM) have been subtracted from total BART employment for all alternatives. Under this approach, alternatives 1 through 3 would not generate any net, new employment from operations. BART employment numbers are from "O&M Cost Estimates Technical Report," prepared by Manuel Padron & Associates, May 1991.

Table 3.6-9

Employment Impacts of Construction and Ongoing Operations  
BART Warm Springs Extension Project

	Construction ----- <sup>1</sup>			Operations ----- <sup>2</sup>		
	Direct Employment	Indirect Employment Effect <sup>3</sup>	Total Employment (Direct and Indirect)	Direct Employment	Indirect Employment Effect <sup>4</sup>	Total Employment (Direct and Indirect)
Proposed Project Range	2,731 2,731 - 2,932	3,933 3,933 - 4,207	6,644 6,644 - 7,129	169	211	304
Alternative 1	NA	NA	NA	N/A	N/A	N/A
Alternative 2	NA	NA	NA	N/A	N/A	N/A
Alternative 3	NA	NA	NA	N/A	N/A	N/A
Alternative 4 Range	1,981 1,945 - 2,159	2,852 2,801 - 3,110	4,833 4,746 - 5,269	108	135	243
Alternative 5 Range	2,180 2,180 - 2,371	3,139 3,139 - 3,414	5,320 5,320 - 5,784	108	135	243
Alternative 6 Range	1,947 1,947 - 2,136	2,804 2,804 - 3,076	4,751 4,751 - 5,212	154	193	347
Alternative 7 Range	2,073 2,073 - 2,207	2,985 2,985 - 3,178	5,058 5,058 - 5,386	154	193	347
Alternative 8 Range	3,460 3,460 - 3,588	4,983 4,983 - 5,166	8,443 8,443 - 8,754	154	193	347
Alternative 9 Range	1,393 1,393 - 1,582	2,006 2,006 - 2,278	3,400 3,400 - 3,861	90	113	203
Alternative 10 Range	1,803 1,803 - 1,992	2,596 2,596-2,868	4,399 4,399 - 4,859	115	144	259

<sup>1</sup> Employment impacts are based on the labor component of the construction cost estimates. Since construction costs would be spread out over a five year period, employment impacts would also cover a five year period. Employment figures refer to person years of employment and are based on prevailing wage data provided by the State of California, Department of Industrial Relations. Operation and Maintenance costs were provided by Manual Padron & Associates and cover a single year of operations. Employment figures refer to persons years of employment and are based on prevailing wage data provided by the State of California Department of Industrial Relations. Employment figures refer to persons years of employment and are based on other alternatives, so that net impacts are discernable.  
<sup>2</sup> The indirect employment multiplier of 1.44 used here is based on an average of multipliers derived by ABAG for highway and public utilities construction sectors.  
<sup>3</sup> The indirect multiplier of 1.25 used here is based on an average of multipliers derived by ABAG for Transportation Services Sectors.  
<sup>4</sup> Source: Vernazza Wolfe Associates 1991

### 3.6 Land Use and Economic Activity

Indirect employment estimates are related to direct employment estimates through empirically validated multipliers provided by ABAG that vary by employment sector. Projections of indirect employment generated by construction and by operations are calculated using different multipliers.

**Direct Impacts.** Construction employment exceeds employment impacts from operations. However, construction employment is of a limited duration, whereas employment from operations is ongoing. Ultimately, increased employment from operations will be more significant since it will be ongoing.

**Construction Period and Operations Impacts.** Although employment requirements are high for construction of the Proposed Project, they would not result in any significant impacts. Employment generation does not completely result in net, new job creation in Alameda County or in the larger San Francisco Bay region. Some workers may change from one job to another or may be under-employed and become fully employed. Consequently, the employment numbers presented in Table 3.6-9 refer to direct and indirect employment generated by system construction and operation, not net job growth - which would be less. Since the San Francisco Bay Area encompasses a large labor market area, it is not anticipated that employment impacts would result in regional labor shortages or competition among related industries for skilled workers, and therefore would not be significant.

**Cumulative Impacts.** There would be no significant cumulative employment impacts from the Proposed Project.

#### Land Use

There are two types of potential impacts on land use: (1) impacts of the alignment and station areas on surrounding land uses, and (2) impacts of system-generated development on surrounding land uses. Since considerations of system-generated development depend on projections of the type of development that could take place, this second land use impact is fairly tenuous and is not discussed here.

Significant land uses impacts could occur from the Proposed Project if it:

- Conflicts with adopted plans and current land uses

### 3.6 Land Use and Economic Activity

- Requires rezoning or general plan amendment in an area which has recently updated its community plan
- Results in the conversion of open space into urban or suburban uses
- Converts prime agricultural land to nonagricultural use or impairs productivity of land
- Results in the construction of a major project in the community

When assessing the Proposed Project and the BART alternatives, only in Central Park would there would be any conflicts with the General Plan (see Section 7, Central Park). Otherwise, the plan anticipates the BART extension. Although the land around the proposed South Warm Springs Station is currently designated for restricted industrial use, the maps accompanying the General Plan already indicate where the BART station would be constructed, and no inconsistency between this land use designation and the construction of a BART station is anticipated.

Station land use impacts at Warm Springs and South Warm Springs stations would be slight, since the stations are located in relatively under-developed areas. However, the proposed Irvington BART Station is located in a developed area that already experiences traffic problems. The presence of a BART station and the associated parking could create negative land use impacts by increasing traffic congestion. Station design is one way in which this issue will be addressed.

Land conversion from open space to suburban uses or from prime agricultural land to nonagricultural uses is not an issue. Although Fremont was once an agricultural community, it no longer can be characterized as such. While there is some land in agricultural use near the proposed Warm Springs Station, adjacent parcels have already been developed in agricultural uses. Other parcels, which are vacant, are already designated for industrial development.

Since the Proposed Project will run along existing transportation networks, the BART extension cannot be characterized as a major project which would significantly alter current land use patterns. However, the proposed aerial alignment through Central Park is inconsistent with the General Plan and is a significant impact; therefore, it can be concluded that there is a significant land use impact associated with the Proposed Project.



**Cumulative Impacts.** There are positive cumulative land use impacts, as the operation of the Warm Springs Extension would encourage and support many of the land use changes anticipated by the Fremont General Plan. Improved transportation access, particularly around the station sites, would encourage new investments in residential and commercial projects, and would support the City's redevelopment efforts in the Irvington area.

#### **Real Estate Development Impacts**

Significant real estate development impacts could occur from the Proposed Project if it:

- Changes the type and timing of development activity by changing the nature and degree of demand for real estate projects
- Increases the demand for housing

These impacts are not adverse if they are consistent with development goals generally agreed to by the community. In the case of the Proposed Project, the extension of BART will affect real estate development in a positive manner.

There is land available for future development within the corridor area. For example, there are large, vacant tracts located on both sides of the railroad corridor between the proposed Irvington and Warm Springs stations. This land is designated primarily for industrial use and the General Plan has established some density limits. This area currently faces some market demand for new light industrial and R&D uses. Over time, this area will be well-sited for new commercial developments. Although residential demand is high and the supply of land for residential use is diminishing, the City of Fremont has been reluctant to redesignate industrial land for residential use.

Infrastructure, such as water and sewer treatment, will generally be adequate to support new development in Fremont. Other public facilities, such as fire and police stations, schools, and parks, would be funded through impact fees on new development to cover expansion of needed services and facilities. In general, Fremont accommodates most development as long as it is fiscally and environmentally sound.

The Proposed Project, when compared to the other BART and non-BART alternatives, would have the greatest impact on new development. Transit could serve as an amenity to new residential, retail, office and R&D developments. Although the corridor area may not

### 3.6 Land Use and Economic Activity

experience more development overall, it could serve to cluster intensive development adjacent to station areas. Municipal zoning regulations would determine the extent to which this could occur.

Consequently, although there are no negative construction or operation impacts from the Proposed Project on real estate development in Fremont, there may be positive cumulative effects on development patterns, in that a BART extension may serve to cluster development and provide improved access to new developments.

**Station Area Real Estate.** For each BART station, Table 3.6-10 briefly summarizes adjacent land uses; future development scenarios, or redevelopment plans; and impacts of a transit station on future development around the station. In most cases, the presence of a station would not dramatically affect station area real estate trends, or neighborhood goals. The one exception would be if local governments intervened and encouraged higher-density developments around station areas.

An assessment of market demand and available land surrounding each proposed station is summarized in Table 3.6-10. Where there is already a strong market demand for newly developed or redeveloped real estate, the majority of development activity could be completed by the time BART is extended. For example, South Warm Springs Station area may be developed by the time BART is extended. However, development patterns in the area favor light industrial and R&D uses, which are less people-oriented and therefore do not benefit as much from transit.

Irvington and Warm Springs Station areas are surrounded by some underdeveloped or vacant land, but are not currently facing strong demand for redevelopment or development. In the Irvington District, the presence of a BART station could enhance redevelopment efforts, perhaps favoring multifamily residential development.

In the Warm Springs Station area, new developments are interspersed with vacant land. Market demand and prices in this area have not yet reached a level to justify development of all sites. In the future, much of the vacant land in the Warm Springs Station area will be developed, most likely in light industrial or R&D use. The presence of a BART station in this area could result in the land being developed more intensely, and perhaps favoring higher rent-paying uses, such as offices, over light industrial development.

**Table 3.6-10  
BART Station Area Development Trends  
And Potential Transit Impacts**

Station Area	Existing Land Uses and Major Activity Centers	Future Development/ Redevelopment Plans	Transit Impacts on Future Development
Fremont	Downtown activities, including office, hospital and multi-family residential. Renovation of adjacent shopping center presently underway.	Potential for future development of high density mixed use projects. Private development plans include high-rise offices, some new retail, multifamily residential and medical facilities. Area is covered by special land use designations appropriate for a CBD.	Development may be completed by the time transit is operating. Transit could help its success.
Irvington	Mixed land uses include commercial and residential. No major activity center.	Station is located in the Irvington Redevelopment Area. At this time, there is no specific redevelopment plan although the city is continuing to improve streets and infrastructure. The city would consider rezoning the station area for land uses compatible with BART. City has adopted a BART Station Concept Plan.	Transit could affect timing and type of redevelopment.
Warm Springs	New United Motors Plant over 1/2 mile away - otherwise vacant land and some new industrial and warehouse development.	Area has private development potential. At present, there is a large supply of undeveloped industrial land. Proposed specific area plan would explore redesignation of some industrial parcels to residential use.	Transit could affect timing and type of new development.
South Warm Springs	Warehouse, R&D, and office uses. Significant new development with concentration of high tech R&D and assembly facilities along Milmont Drive.	Continued development of large-scale parcels for R&D, industrial or warehouse development.	If current development trends continue, development at low densities may be completed by the time BART is operating. The main exception would be if the city elected to restrict development to higher densities, in which case BART could affect the timing and type of new developments.

Source: Vernazza Wolfe Associates, Inc. and Recht Hausrath & Associates, 1991.

### 3.6 Land Use and Economic Activity

For those station areas where current trends favor low-density developments, it is recommended that local agencies consider fostering more intensive development in station areas. This may result in the need to postpone development activities until higher rents support more intensive development. Clustering of development around BART stations would be desirable for a number of reasons:

- Increase transit system patronage
- Reduce auto dependency, traffic congestion, and air pollution
- Enhance the business environment
- Allow Fremont to control and focus growth
- Use of existing infrastructure in a cost-effective manner

It is important that this clustered development support the food, banking, retail, and postal needs of non-drivers employed in the area, so that they would not be isolated. The presence of a transit system, in itself, would not result in more intensive development around station areas unless and until there is adequate market demand. If that market demand is to be realized in intensive station area development, local land use policies need to be supportive. In order to encourage clustering of development around BART stations, Fremont may wish to adopt flexible and higher-density zoning policies such as the following:

- Increase FARs for new development located adjacent to stations to optimize the benefits of the station and decrease FARs located elsewhere (if the City does not want greater densities overall)
- Increase FARs for new development located adjacent to the stations, without changing FARs elsewhere (which appears to be the direction taken in the General Plan)
- Provide density bonuses for development around transit stations
- Decrease parking requirements for developments near stations

For those station areas where redevelopment planning and/or activities are underway, it is recommended that local agencies consider a more active role in land assembly. This recommendation should apply especially if it appears that without public intervention, redevelopment of station area sites would not be of the type or the densities that are compatible with transit.

### **Municipal Revenue Impacts**

Significant revenue impacts could occur from the Proposed Project if it:

- Reduces the revenues that the City collects to fund services

There should be no impact from the Proposed Project on municipal revenues. Property and sales taxes are the principal revenue sources that could be affected by improvements in the transportation system.

Property tax revenues could rise if land were more intensively developed adjacent to BART stations. For example, a developer could decide to construct office space adjacent to a transit station, whereas in the absence of the transit station, the market might only support warehousing or some other light-industrial use. Since office space represents a higher-value land use, there would be an increase in property tax revenues.

The extent to which there is a positive net impact on property tax revenues is limited. In general, if property values rise in the Warm Springs Corridor due to the BART extension, these higher values will result in greater property tax revenues. This has occurred at the Walnut Creek and Concord BART station areas. However, property tax revenues lag behind price appreciation.<sup>1</sup> In some cases, there may be relocation of development activity within a city or region. Although there is a shifting of the location of revenue growth, there is not an absolute increase. Another possibility is that land would be developed more quickly because the rail system would improve accessibility. Again, in this case, there would be no greater absolute growth over time, but in the short term (20 years or less) there could be accelerated growth.

An exception to these three cases would be a situation in which a transit station encouraged higher quality construction than would otherwise occur in the City or region. In this latter case, there would be a positive net revenue impact.

---

<sup>1</sup> Proposition 13 limits growth in property taxes during the holding period of the same owner. The only way in which property taxes increase more than the limit stipulated under Proposition 13 is if there is a change in ownership or an improvement is made to the property. Consequently, if the presence of BART resulted in higher values structures, the property tax revenue base would lag behind property value increases. It could only "catch up" to reflect market values when properties were sold or improved.

### 3.6 Land Use and Economic Activity

Sales tax revenues would increase only minimally. Retailers may alter their locational decisions based on the presence of rapid transit. However, it is likely that the clustering of retail activities at a transit station is due to a relocation of area retailers, rather than to an absolute growth in the number of establishments and associated sales. For example, it is likely that the presence of a BART station in the Irvington District will strengthen existing retail demand and attract more businesses to that area.

It is unlikely that municipal revenues would experience any direct, cumulative or construction period impacts associated with the Proposed Project.

#### **Neighborhood Impacts**

Significant neighborhood impacts could occur from the Proposed Project if it:

- Disrupts the physical and social arrangements of an established community
- Conflicts with established recreation or educational uses of an area
- Leads to development directions that run counter to current trends and neighborhood goals

Many aspects of the construction and operational impacts related to neighborhoods are discussed in separate sections of the EIR (e.g., visual, transportation, displacement, and Central Park). This section assesses the BART alternatives relative to the functioning of neighborhoods (and the desirability of living within them) and localized development impacts.

The Proposed Project would impact neighborhood areas minimally since most of the BART alignment would be located in or adjacent to an existing railroad ROW. (The only exceptions are the initial segment between Fremont BART and the Irvington Station that contains Fremont Central Park, discussed in Section 3.7 of this EIR.)

There would not be any significant, direct neighborhood impacts associated with operation of the Proposed Project. However, there could be some positive cumulative impacts on station area development patterns (discussed above) and some potentially significant construction period impacts on existing businesses. Potentially significant construction period impacts are discussed below.

**Neighborhood Construction Impacts.** Initially, there are impacts stemming from construction of the fixed rail system and the station areas. Station construction can be disruptive to surrounding residential and commercial activities. The Central area and the proposed Irvington Station area both contain retail and service establishments and construction period activities could affect sales. Problems could occur if construction activities restrict access or diminish parking supply.

**Neighborhood Mitigation Measures.** Since construction of the BART extension could temporarily affect retail activities in Central Fremont and the Irvington area, the following mitigation measures are suggested:

- Construction activities should be carefully staged, so that there is minimal disruption to commercial activities in downtown Fremont and the Irvington District.
- Construction traffic control criteria should be developed in consultation with local business associations before any construction activity is undertaken by BART. A traffic control plan could be prepared in accordance with these criteria.

**Residual Impacts After Mitigation.** Construction in retail areas almost always has a short-term negative impact on sales. If BART implements effective mitigation measures which maintain area access and parking supply, the short-term impacts of construction on retail activity can potentially be reduced below a level of significance. However, short-term impacts should be followed by long-term positive impacts on sales.

### **Displacement**

Significant displacement impacts could occur from the Proposed Project if it:

- Affects existing houses and businesses
- Displaces a large number of people and businesses due to the inability to locate replacement alternatives

The Proposed Project and other BART alternatives will lead to some displacement impacts. These would be unavoidable, direct impacts. However, the selection of an alignment in the railroad ROW will minimize the number of displacements. Also, many parcels will be partially impacted, but, in most cases, utilization of the properties will remain unaffected.

### 3.6 Land Use and Economic Activity

Tables C-1 through C-7 in Appendix C present detailed information on the residences, businesses, and other land uses that are potentially affected by construction of the Proposed Project or the alternatives.<sup>1</sup> This includes station facilities, parking, tailtracks and the car washing facilities.

In many cases, potentially affected parcels are undeveloped. The developed parcels are of greatest concern in assessing displacement impacts, and are occupied primarily by commercial and light industrial users. Some developed parcels are unoccupied at present; they have not been included in the number of businesses that could be affected by a BART extension. As shown in Table 3.6-11, the total number of businesses which would be impacted by the Proposed Project is 83. Some residences could be potentially affected, and these total 17.

**Relocation Mitigation Measures.** Once a project has been adopted, accurate relocation costs can be determined. First, BART would conduct a survey of structures that are potentially affected to determine exactly which residential and commercial buildings would be displaced. After a complete inventory of the uses on station sites and along the project corridor is completed, draft and final relocation impacts statements will be prepared, and assistance plans would be implemented by BART. All interests in real property will be valued via appraisal to determine fair market values. The fair market value will be the amount of just compensation offered to each property owner during the negotiation process.

The Federal Uniform Relocation and Real Properties Acquisition Policies Act of 1970, as adopted by the State of California in 1971, sets forth the mandatory minimum requirements for acquisition, appraisal, and relocation payments and services that result from any public agency displacements. BART is required by law and associated policy regulations to provide relocation assistance to any lawful residential household or business operation that is displaced as a result of the acquisition of land for BART projects. A relocation assistance program will be created that will minimize the financial impacts to residential as well as non-residential displaces by providing moving and related eligible expenses as required by law for successful relocation. Displaced businesses may also file claims for loss of goodwill payments as provided in the California Administrative Code. These claims are not part of the relocation assistance program, but are administered as part of the real property appraisal and acquisition program.

---

<sup>1</sup> For the purposes of this EIR, it is assumed that Alternatives 1, 2 and 3 do not result in any displacements. If there is any displacement associated with the planned widenings of I-880 or I-680 (under Alternative 3), they would be discussed in separate EIRs for those projects.



**Table 3.6-11  
Summary of Potential Displacements From the Proposed Project  
and BART Alternatives**

	No. of Businesses	No. of Residences
Proposed Project	83	17
Alternative 4	43	17
Alternative 5	43	17
Alternative 6	80	3
Alternative 7	121	5
Alternative 8	83	39
Alternative 9	40	3
Alternative 10	80	3
Alternative 11	83	17

Sources: Recht, Hausrath Associates, 1991.  
Vernazza Wolfe Associates, 1991.

Property owner occupants will be allowed to transfer their existing tax base to their replacement property within Alameda County pursuant to State Law. Transfer to other counties is subject to the approval of the replacement county's taxing authority. There are certain limitations and other restrictions regarding the transfer. Specific information will be presented to eligible owner occupants during the property acquisition process.

**Residual Impacts After Mitigation.** After implementation of the relocation assistance described above, the financial impacts involved in displacement would be reduced to levels that would be less than significant. The relocation of some residences and businesses cannot be avoided. Since the supply of housing in Fremont has steadily expanded over the past thirty years, it will not be difficult to locate replacement housing within the community.

The non-residential parcels that are impacted are currently occupied by businesses located in older industrial developments. In most cases, these developments include several buildings, and only the rear buildings would be taken. Some of these businesses engage in automotive services or are machine shops. There are relocation opportunities for these businesses in Fremont, although rents may be higher. To the extent that a business could not afford higher rents, the extension of BART could lead to the loss of some businesses in Fremont. Impacts associated with displacement out of familiar settings and away from neighborhood services are considered unavoidable adverse impacts.

### 3.6.3 IMPACTS OF DESIGN OPTIONS

**Neighborhood Impacts.** Between Central Park and the proposed Irvington Station there is one residential neighborhood (Valdez Way/Vaca Drive/Valero Drive), located east of the railroad ROW. The Design Options 2A and 3 through Central Park could affect this area more than the subway design options. The wider swing around Lake Elizabeth, which positions the BART tracks closer to Valdez Way could result in a higher level of visual and noise impacts (see Sections 3.8 and 3.13).

The Paseo Padre Parkway Design Option differs in its potential impacts on this residential area. If the tracks are depressed at Paseo Padre Parkway, there would be fewer visual and noise effects than the at-grade option, and an aerial crossing would have the greatest impact of the three potential vertical alignments. An at-grade crossing of Paseo Padre Parkway would have a higher level of impacts followed by the BART aerial option over Paseo Padre Parkway.

**Displacement Impacts.** Because the various design options through Central Park and at the intersections of Paseo Padre Parkway and Washington Boulevard do not result in differences in displacement activity, they are not listed separately on Appendix C tables. However, although the UPRR Design Option would still affect the same number of parcels as would the other design options, it would impact a smaller amount of each parcel. Consequently, the extent of displacement of existing uses could be reduced under the UPRR Design Option.

**Additional Impacts.** Other than these potential impacts, Design Options 2A and 3 would have a significant impact on land use since the aerial alignment through Central Park is inconsistent with the policies of the adopted Fremont General Plan.

### 3.6.4 IMPACTS OF ALTERNATIVES 1, 2, and 3

Land use and economic activity impacts of these non-BART alternatives are negligible except where the Fremont General Plan has anticipated new station construction that would not materialize.

### 3.6.5 IMPACTS OF ALTERNATIVES 4 THROUGH 11

**Population Impacts.** No difference from the Proposed Project.

**Employment Impacts.** Employment levels are shown in Table 3.6-9. Among the various BART alternatives, Alternative 8, the Osgood Road/Warm Springs Boulevard alignment, would generate the highest level of direct employment. The lowest level of employment would be generated by Alternative 9, which is the 5.4-mile extension with only one station at Warm Springs.

Employment generated by operations and maintenance is directly related to the length of the proposed extension and the number of stations that would be included. Alternative 9, a 5.4-mile extension with only one station, would generate the lowest level of employment. Following Alternative 9 in ascending order are: Alternatives 4 and 5 (5.4-mile extension with two stations), Alternative 10 (7.8-mile extension with one station), and alternatives 6, 7, 8 and 11 (7.8-mile extension with two stations), and finally, the Proposed Project.

**Land Use Impacts.** The long-term land use effects of all the alternatives would be generally beneficial to the community. Those alternatives without an Irvington Station would have smaller benefits, because the City has planned the future Irvington BART Station as a major activity center in the Irvington District.

**Real Estate Development Impacts.** Those alternatives with a shorter extension (4, 5, and 9) and only one station (9 and 10) will benefit development patterns less than those with the full 7.8-mile extension and at least two stations. However, similar to the Proposed Project, no negative impacts are anticipated from the alternatives on real estate development trends.

**Municipal Revenue Impacts.** Property and sales taxes are the principal revenue sources that could be affected by improvements in the transportation system. However, as discussed earlier, there would be no significant impacts on the level of revenues collected by the City. If there is a slight increase in revenues, the alternatives which include two stations, such as Alternatives

### 3.6 Land Use and Economic Activity

4 through 8 and 11, would be second in importance to the Proposed Project. Next would be Alternative 10 (full extension, one station) followed by Alternative 9.

**Neighborhood Construction Period Impacts.** Since all BART alternatives pass through Central Fremont and Irvington, construction of any of the BART alternatives could theoretically affect retail activity in these areas. However, those alternatives which include a station at Irvington could potentially have the greatest impact. These include the Proposed Project and Alternatives 4, 5 and 11.

**Mitigation Measures:** Mitigation measures would be the same as the Proposed Project.

**Residual Impacts After Mitigation:** Residual impacts would be the same as the Proposed Project.

**Displacement.** As shown in Table 3.6-11, the greatest number of business displacements is associated with Alternative 7 which could potentially affect 121 businesses and 5 residences. Alternative 8 (Osgood Road/Warm Springs Boulevard alignment) could affect the greatest number of residences (39), but the number of businesses potentially affected are fewer (83) than those for Alternative 7. The fewest number of potential displacements is associated with Alternative 9, the 5.4 mile extension with one station at Warm Springs.

**Mitigation Measures:** Mitigation measures would be the same as the Proposed Project.

**Residual Impacts After Mitigation:** Residual impacts would be the same as the Proposed Project.

## 3.7 FREMONT CENTRAL PARK LAND USE AND RECREATION

### 3.7.1 SETTING AND EXISTING CONDITIONS

Fremont Central Park covers approximately 440 acres in central Fremont. Known as Fremont's one "city park," Central Park was designed to serve the whole city as well as the immediately surrounding neighborhoods.<sup>1</sup> The park boundaries are Stevenson Boulevard, Paseo Padre Parkway, and the Southern Pacific Transportation Company (SPTCo) and Union Pacific Railroad (UPRR) rights-of-way (see Figure 3.7-1).<sup>2</sup>

Central Park is heavily used by people from all parts of the community. Its role as a civic and recreational attraction is particularly important in light of the fact that Fremont has not had a strongly defined central business district. For some, the park's role as an open space preserve in the center of the City is especially valued, since these natural areas are uncommon elsewhere in Fremont. The open view across Lake Elizabeth towards Mission Peak has become an important part of Fremont's image. Views of Central Park are found in Figure 3.7-2 and in Section 3.8-2. The visual qualities and characteristics of the park are described in detail in Section 3.8, Visual and Aesthetic Quality.

Central Park was designated on Fremont's first General Plan in 1956 when the City was incorporated. Land acquisition for the park began in 1959, with expansions occurring through a series of eight transactions over the subsequent 25 years. Funds for acquisition of the parklands came from the City's General Fund, and through several park acquisition bond issues, a local bond issue and a federal grant program.

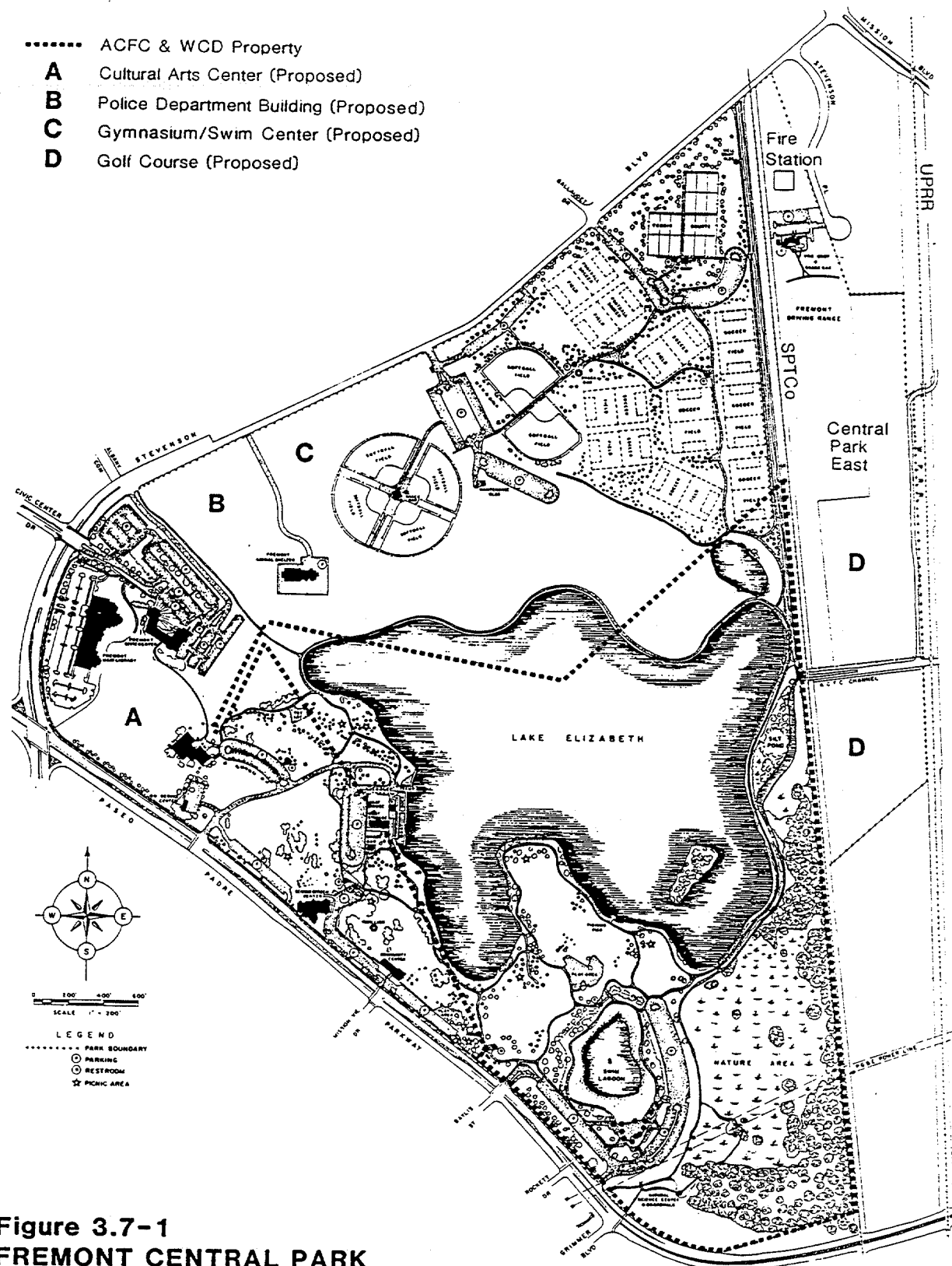
A Central Park Master Plan exists. It has not been updated since 1985 and does not reflect all of the park improvements that have been recently implemented by the City. Some components of the old master plan are no longer proposed. The new Fremont General Plan

---

<sup>1</sup> City of Fremont, *Fremont General Plan*, Preliminary Draft II, March 1991, p. 6-11. Fremont has 49 parks with a total acreage of 1,012 acres. Central Park is the only park area recognized as having a citywide constituency.

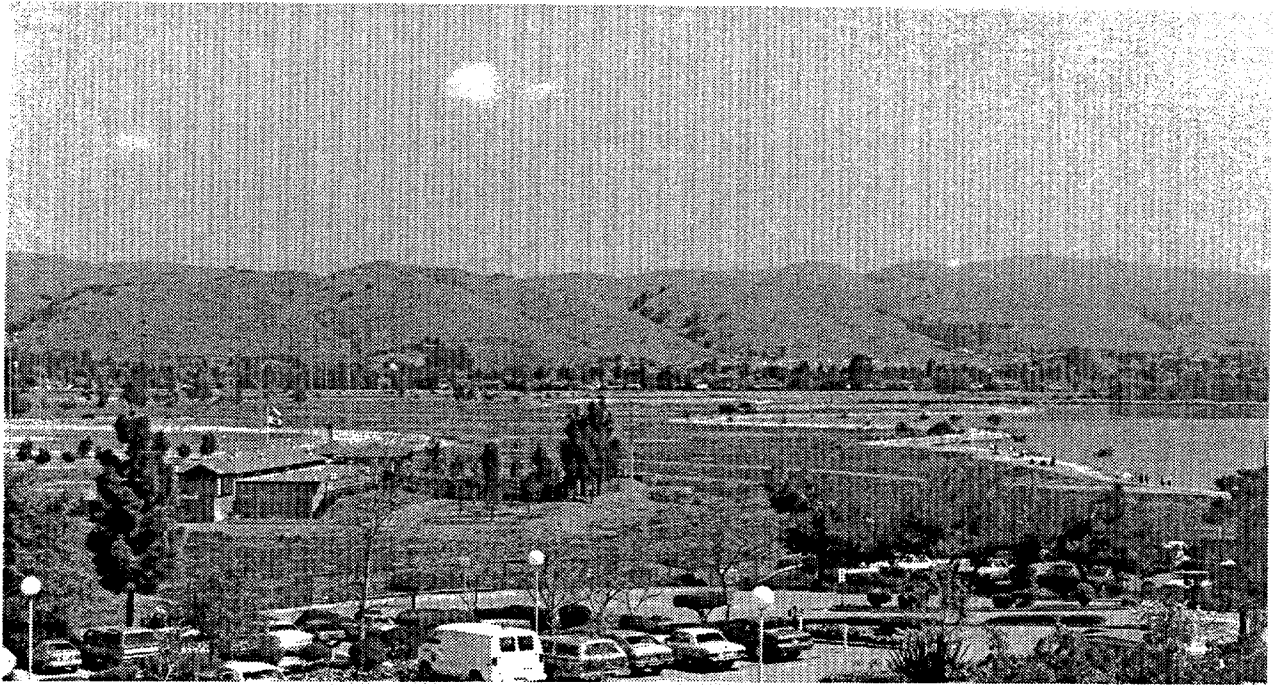
<sup>2</sup> It should be noted that the portion of the Park between the two railroad rights-of-way is often referred to as "Central Park East."

- ACFC & WCD Property
- A** Cultural Arts Center (Proposed)
- B** Police Department Building (Proposed)
- C** Gymnasium/Swim Center (Proposed)
- D** Golf Course (Proposed)



**Figure 3.7-1  
FREMONT CENTRAL PARK**

Source: City of Fremont, 1991



View of Central Park From Civic Center. Animal Shelter and Softball Complex on Left; Lake Elizabeth on Right



View across Arm of Lake Elizabeth along Proposed Project Alignment

**Figure 3.7-2**  
**CENTRAL PARK VIEWS**

SOURCE: Donaldson Associates, 1991

### 3.7 Fremont Central Park

calls for the preparation of a long range Central Park management plan.<sup>1</sup> Figure 3.7-1 identifies the current land uses within the park and generally locates the sites of proposed projects now under consideration by the City.<sup>2</sup>

Currently, land within the park is held in two ownerships. Approximately 266 acres is owned by the City of Fremont, while 174 acres, including most of Lake Elizabeth, is owned by the Alameda County Flood Control and Water Conservation District.

The 174 acres of Flood Control District land is operated and maintained as a flood control facility. Under a cooperative license agreement, which is renewable, the City is permitted to operate the District's property as a park and recreation facility for general public use.<sup>3</sup> However, the District retains the primary right to operate the property, including Lake Elizabeth and Mission Creek, as a flood control facility. The contract between the City and the District states that flood control use of the land must take precedence over all other uses. The District must also approve any grading, structures or improvements on the site, their approval is based on the proposed facilities' non-interference with flood control, drainage and water conservation activity.

Other real estate interests directly affecting Central Park include the SPTCo rail right-of-way, which separates Central Park from the East Central Park sub-area. Pacific Gas and Electric Company has a utility easement which crosses the nature area at the southern end of the park. Federal funding assistance was obtained by the City and the Flood Control District to assist in purchasing some of the lands included in the park. The funds were granted with the provision that the lands be utilized for the appropriate public purposes.

Today, Central Park serves as a public park facility and holds a Civic Center complex. The park provides almost 45 percent of the recreational and park space in the City of Fremont, and the civic center complex serves as the administrative and public service center of the community. Additionally, the City is currently constructing a new fire station on a site in the East Central

---

<sup>1</sup> City of Fremont, 1991, *Fremont General Plan, Preliminary Draft II*, Policy OS 3.3.1, Implementation 1, March, p. 6-31.

<sup>2</sup> Jack Rodgers, Director; Dennis Speracino, Deputy Director; Patrick Hayes, Environmental Services Supervisor; 1991, Fremont Leisure Services Department, personal communications, March 28.

<sup>3</sup> City of Fremont and Alameda County Flood Control and Water Conservation District, 1968, *Real Property License Agreement*, June 25, as amended January 7, 1971.



Park area, between the two railroad corridors, with access from Stevenson Place. The locations of existing facilities are shown on Figure 3.7-1, and a listing of facilities shown in a text box at right.

Central Park is considered to be approximately 85 to 90 percent developed at present, with about 60 acres of undeveloped open space located in three main areas: along Stevenson Boulevard near the softball fields, between the soccer and softball fields and Lake Elizabeth, and in Central Park East. Most future recreational facility development would be concentrated in these areas.

Planning is currently underway for the following four major additions to the park and Civic Center facilities:

**Gymnasium/Swim Center.** This facility would be located generally in the area bounded by Stevenson Boulevard, the softball fields and the animal shelter. A building of approximately 57,000 square feet, plus parking for about 330 vehicles is anticipated.

**Golf Course.** Planning feasibility studies are underway for an additional golf facility in Central Park East. To date, there is no program specifying the length of the course or the number of holes, as the design of the facility is dependent on environmental constraints as well as the space available. An Environmental Impact Report is being prepared on this project.

**Police Department Building.** A new facility to house the City's police department is under consideration for a location between the Civic Center, the animal shelter and Stevenson

**Existing Central Park Facilities**

- Fremont Civic Center with Administrative Offices, Council Chambers, Police Department and related offices.
- Fremont Main Library and Alameda County Library Offices
- Fremont Animal Shelter
- Senior Citizen Center
- Community Center
- Lake Elizabeth, with approximately 83 surface acres
- Boat House, Docks and Snack Bar
- Swim Lagoon (7.5 acres), Changing room, restrooms, snack bar
- Band pavilion
- Eighteen tennis courts, and a pro shop
- Six softball fields, snack bar, guard shack, support space
- Ten soccer fields, snack bar
- Golf driving range, pro-shop and cafe
- About 200 picnic tables; 50 in reserve group areas
- Four children's playgrounds
- Almost 5 miles of walking/jogging trails
- Ten parking lots with 2,179 spaces
- Nature Area, 50 +/- Acres, Boardwalk and Nature Center
- Fishing Pier (undergoing rebuilding)
- Undeveloped open turf areas of approximately 30 acres
- Ancillary buildings, including seven restrooms (plus one under construction), a park service center, a maintenance building, well and pump buildings, and a boat storage area

### 3.7 Fremont Central Park

Boulevard. A building of approximately 94,000 square feet on a site of about seven acres is programmed.

**Cultural Arts Center.** A cultural arts center is being planned for a location south of the Civic Center and Main Library buildings, with frontage along Paseo Padre Parkway. The cultural arts center is proposed to include two performing arts theaters, one with 1,240 seats and the other with 350 seats, a museum and art gallery, a community access TV studio, a civic garden, and parking for about 550 vehicles in a structure with one below-grade level.

None of these four proposed facilities were included in the Central Park Master Plan. The cultural arts center is identified in the Fremont General Plan, and the need for a police department building is briefly discussed. The open space between the softball fields and Lake Elizabeth is not currently the subject of any specific improvement plans, and will continue to be maintained as open space for the immediate future. Although not a park project, Stevenson Boulevard is proposed to be widened for a distance of about 2,000 feet extending northeast from Albany Commons.

#### **History of the Planned BART Extension through Central Park**

The Fremont General Plan and the Central Park Master Plan have shown the planned extension of BART through Central Park since 1979. This occurred in formal actions taken subsequent to the completion of BART's 1979 Warm Springs Extension Study.<sup>1</sup> In Resolution 4700 (November 13, 1979) the City Council established a General Plan Alignment for BART between Walnut Avenue and Paseo Padre Parkway (through Central Park). A year later (November 11, 1980), in Resolution 4958, the City Council expanded its action to address the proposed extension of BART to the Warm Springs District. In Resolution 4958, the Council established the City's preference on certain issues relating to the future Warm Springs Extension and specifically advised BART that:

- a. A BART line extension to the Warm Springs District is in conformance with the General Plan; (and)
- b. Only the direct subway alignment through Central Park is in conformance with the General Plan;

---

<sup>1</sup> BART, Department of Planning and Analysis, 1979, *Warm Springs Extension Study*, August.

### 3.7 Fremont Central Park

This is confirmed in the new Fremont General Plan which states in Policy OS 3.3.1:

Implementation 2: A BART extension through Central Park shall be trenched, covered and sound insulated under Central Park, at a minimum from Stevenson to Paseo Padre.<sup>1</sup>

#### Park Usage Levels

Fremont Central Park is a heavily used community facility. The Civic Center complex is the City's administrative center, and provides office space for most city employees. At the Civic Center complex, hundreds of visitors on municipal business are served each day, and a number of public functions and meetings are conducted. However, the focus of this analysis is on recreational activities in Central Park, as only certain recreational areas would be affected by the Proposed Project; the design options; or the other proposed alternatives.

The average number of annual visits to Central Park is difficult to estimate. Visitor counts are not conducted by the City, and most visits do not involve any type of transaction that can be tallied. However, estimates have been made of park usage levels by type of activity after consultation with the Community Services Department staff members.<sup>2</sup> Major activities and estimated number of annual visits to the park associated with each are shown in Table 3.7-1. As indicated, the estimated level of recreational use in Fremont Central Park reaches about 1,150,000 visits per year.

### 3.7.2 IMPACTS OF PROPOSED PROJECT

#### Criteria of Significance

If the proposed BART Warm Springs Extension results in substantial long-term detriments to existing and planned land uses, or conflicts with established recreational facilities<sup>3</sup> within Fremont's Central Park, then a finding should be made that the project could have significant

---

<sup>1</sup> City of Fremont, 1991, *Fremont General Plan, Preliminary Draft II*, March, p. 6.31

<sup>2</sup> Jack Rodgers, Director, Dennis Speracino, Deputy Director, and Patrick Hayes, Environmental Services Supervisor, Leisure Services Department, 1987 and 1991, City of Fremont, personal communications, July 30 and March 28.

<sup>3</sup> *State CEQA Guidelines*, Cal. Administrative Code, Sec. 15000 et. seq., Appendix G(w).

adverse environmental effects in these areas. The determination of whether the potential land use or recreational impact is substantial must depend upon the extent of the disruption and the effectiveness of feasible mitigation measures in reducing or eliminating the impacts.

The State CEQA Guidelines indicate that significant land use impacts can be found when a proposed activity is in conflict with the adopted environmental plans and goals of the community.<sup>1</sup> Although General Plans prepared under the applicable provisions of the California Government Code are not considered exclusively "environmental" plans, a significant adverse land use impact may occur when a direct conflict with specific land use proscriptions contained in an adopted Land Use Element of the General Plan is identified.

**Direct Impacts**

The Proposed Project would involve the construction of an aerial structure and the operation of BART trains through specific areas of Central Park, as discussed below and shown on Figures 3.7-3 and 3.7-4.

The alignment for the Proposed Project enters Central Park from the north on an aerial structure crossing Stevenson Boulevard approximately 1,500 feet east of Civic Center Drive. It then curves gradually to the southeast across what is now the edge of the infields of two of the softball fields and continues south across the east arm of Lake Elizabeth, through the northern end of the natural area of riparian forest and over the SPTCo tracks at the park boundary. Where the alignment would enter the park (at Stevenson Boulevard), the bottom of the aerial

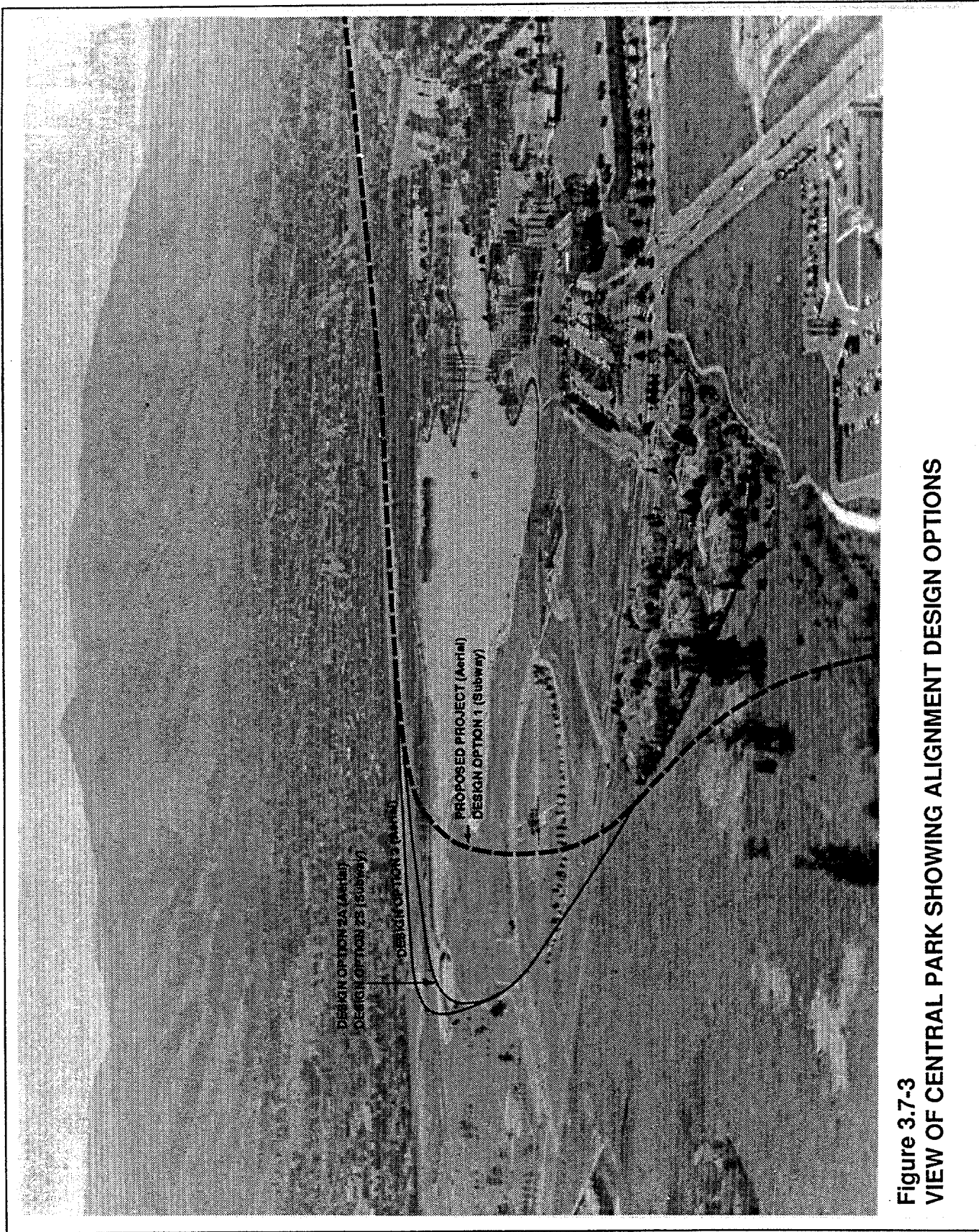
**Table 3.7-1  
Estimated Annual Recreational Visits  
To Fremont Central Park  
By Type of Activity**

Type of Activity	Estimated Visits
Walking and Jogging	325,000
Softball	133,000
Tennis	20,000
Youth Soccer	44,000
Golf Center	92,000
Private Boat Launches	12,000
Boat Rentals	26,000
Swim Lagoon	53,000
Reserve Picnic Areas	20,000
Non-Reserved Picnics	90,000
Special Events	10,000
Senior Center	35,000
Other Activities <sup>1</sup>	<u>290,000</u>
<b>Total</b>	<b>1,150,000</b>

<sup>1</sup>Other activities include fishing, bicycling, children's playgrounds, nature study, special summer camps, fun runs, school parties, etc.

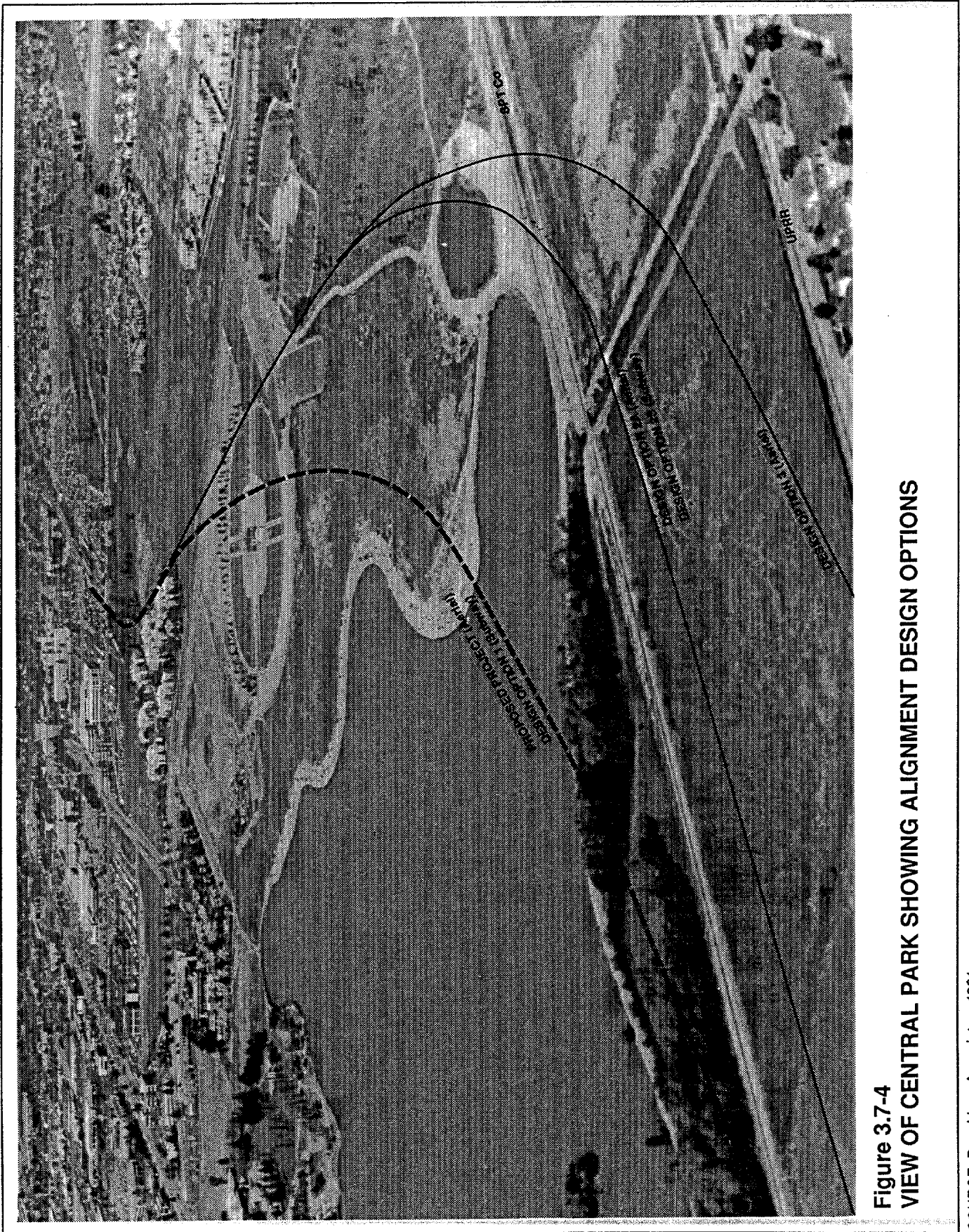
Sources: City of Fremont, Donaldson Associates.

<sup>1</sup> Ibid, Appendix G(a).



**Figure 3.7-3**  
**VIEW OF CENTRAL PARK SHOWING ALIGNMENT DESIGN OPTIONS**

SOURCE: Donaldson Associates, 1991



**Figure 3.7-4**  
**VIEW OF CENTRAL PARK SHOWING ALIGNMENT DESIGN OPTIONS**

SOURCE: Donaldson Associates, 1991

### 3.7 Fremont Central Park

girders would be approximately 18 feet above the street and the top of the rail would be about 23 feet above the street. Continuing through the park the bottom of the aerial structure would have small variations in elevations, generally following the contours of the existing ground surface with the bottom of the aerial structure remaining between 13 and 19 feet above the existing ground surface. The structure would be at its lowest height where it crosses over the existing nature area before it would begin to rise to pass over the SPTCo with 23' 6" of clearance. Over Lake Elizabeth the bottom of the girders would be approximately 15' 6" above the lake surface.

Typically, the vertical supports for BART aerial structures are spaced 80 to 90 feet apart. Since approximately 4,400 feet of this alignment would be located within the park boundaries, there would be between 48 and 55 vertical supports constructed within the park along this alignment, of which 5 or 6 would be constructed in the Lake. Photo simulations of the aerial structure passing through Central Park are found in Section 3.8, Visual and Aesthetic Quality.

The BART alignment would consist of an overhead structure, which would be 26 feet wide, and would cover about 115,000 square feet (2.6 acres or 0.6 percent) of the land in the park. Of this only about 1,100 square feet would be permanently occupied by the 5-foot-wide hexagonal support columns. The rest of the land beneath the aerial structure would be open to public access and could continue to be used for recreational purposes following construction. The aerial structure would not significantly reduce the amount of land available within the park for recreational or civic purposes.

The placement of the aerial structure along this alignment would have direct, long term effects on several of the recreational facilities in the park. If the two softball fields were not replaced, up to one-third of the league games would have to be moved to other fields or simply not be scheduled. This could reduce the use of the park by as many as 44,000 annual recreational visits. This would meet the CEQA Guideline criteria for significance as a conflict with an established recreational facility, hence it is considered a significant adverse environmental effect of the project.

Some of the sailing activities in Lake Elizabeth would also be adversely affected. The starting mark and one of the corner buoys of the "olympic triangle" for sailing races are located near the alignment in the affected arm of Lake Elizabeth. Smaller boats, e.g., those with masts less than 15 feet tall, could use the existing course, although the support structures in the lake could affect the course layout and would add obstructions and reduce the sailor's options for running the course. The aerial structure would be supported with five to six vertical columns

### 3.7 Fremont Central Park

placed in the lake. The overhead structure might also affect the localized wind patterns in the arm of the lake and could reduce the quality of the course. While the construction of the aerial structure would affect the quality of sailing, the established programs would be able to continue. Therefore, the impacts, while adverse, are judged to be less than significant.

The aerial structure also would pass over the walking trail around Lake Elizabeth at two locations. Assuming that most walkers can walk the 1.9-mile distance around the lake in 20 to 30 minutes, they would be within 300 feet of the aerial structure for 5 to 8 minutes<sup>1</sup> of each lap around the lake. Since BART trains would pass, on average, approximately every 2.25 minutes during peak periods and every 3.75 minutes in off-peak periods, all of the walkers could expect to see and hear one to three BART trains passing each time they circle the lake. Bicyclists and joggers, who move more quickly than the walkers, would experience train pass-by less frequently. Train pass-bys also would be less frequent on Saturdays and Sundays when the largest number of walkers, joggers and bicyclists are present because the BART trains would pass, on average, every 10 minutes.

Because of the grade-separated trackway, the train pass-bys would not directly affect the walking, jogging or bicycling activities on the paths below. However, they could interfere with normal conversation between recreationalists who find themselves beneath or close to the aerial structure during the 2 to 10 second time it would take a train to pass.<sup>2</sup> In summary, the Proposed Project would have a minor to moderate effect on recreational walking on the paths around Lake Elizabeth. However, this would not be a significant adverse environmental impact of the project.

The aerial structure and the train pass-bys also would introduce a significant new visual element into open vistas available from most points along the pedestrian paths around Lake Elizabeth. The effects on these views as well as the potential changes in the noise environment are specifically addressed in the following section (Section 3.8, Visual and Aesthetic Quality) and in Noise and Vibration, Section 3.13 of this EIR. As noted above, the City of Fremont has determined that an aerial alignment through Central Park would conflict with the City's General Plan. When the aggregate impacts on recreational activities, visual impacts and noise impacts

---

<sup>1</sup> About 0.51 miles (2,700 feet) of the shoreline path would be within 300 feet of the aerial structure.

<sup>2</sup> This assumes that BART trains passing over the east arm of the lake would be between 3 and 10 cars long (210 ft. - 700 ft.) and would be traveling between 50 and 75 mph.



are considered together with the City's finding that an aerial structure would not conform with the General Plan, it is concluded that the implementation of the Proposed Project on an aerial alignment through Central Park would result in a significant adverse land use impact.

### **Cumulative Impacts**

As described above, (3.7.1, Setting and Existing Conditions), there are four projects under consideration by the City of Fremont for future development in Central Park. They are a Gymnasium/Swim Center, a Golf Course, a Police Department Building and a Cultural Arts Center. Besides the proposed BART Warm Springs Extension project, there are no other planned or foreseeable future projects proposed by other agencies that would affect land uses or recreational activities within Central Park.

The four City proposed projects would be consistent with the civic and recreational purposes of the park. Since the proposed BART extension is the only active proposal with the potential to be inconsistent with the park purposes, no cumulative impacts from the potential aggregate effects of this and other projects are expected.

### **Construction Period Impacts**

Although the overall construction period for the Proposed Project would last about four years, the activity within Central Park would be intermittent and variable in its intensity. Most of the construction activity would occur in the first two years, during the term of the civil and structural construction contract, under which the aerial structure would be built.

The construction area would be generally maintained within the 50-foot-wide alignment that BART requires. A temporary construction access road would be necessary along the entire alignment for the full length of the civil and structural contract plus the time needed to lay the tracks on top of the aerial structure, a total of almost three years. The civil and structural contractor also would have a secured construction storage and staging area that would be located on undeveloped land between the Fremont BART Station and Paseo Padre Parkway.

Construction would begin with the preparation of the alignment and placement of the temporary access road along it. This would require closure of the two affected softball fields and construction of a causeway and/or a coffer dam across the east arm of Lake Elizabeth. Maintenance of safety and security along the construction alignment would temporarily disrupt public access across the corridor for portions of the construction period. The greatest potential

### 3.7 Fremont Central Park

for inconvenience would occur at the trail around Lake Elizabeth, the paths between the softball fields and nearby parking, and the paths providing access to the residential neighborhoods east of the park. These impacts would leave minor to moderate temporary adverse effects.

The construction contracts would require the contractor to take special measures to protect the clay bottom lining of the lake and to provide additional protection from lake seepage and potential pollution of the underlying aquifer during construction. Where disturbed, the lake bottom would be reconstructed with clay materials to restore its low-permeability as a part of the construction work. The clearing of the construction area would remove a portion of the wooded area and wetlands traversed by the project corridor along the eastern shore of Lake Elizabeth. (The effects of this are addressed, above, in Section 3.5, Ecosystems.) Since Lake Elizabeth is a flood control storage facility and a major source of inflow comes from the east, the seasonal needs for storage capacity would have to be monitored and a means of inflow across the construction zone into the lake would have to be maintained, as necessary, during the construction period. (See Section 3.2, Hydrology.)

The actual sequence of structural work is not known and it would be left to the discretion of the contractor to choose the most efficient way. The contractor could choose to do all the support foundations before commencing work on the columns, or the work could begin at the north end and move south or begin in Lake Elizabeth and work in either direction. Once the structures are completed, there could be months of inactivity along the alignment within the park until the track is laid. This would involve equipment on the aerial structure and concrete mix trucks and concrete pumpers accessing the structure from the ground along the construction access road. Construction activities under the civil and structural contract would end with the restoration of Lake Elizabeth, site cleanup, restoration of the ground surface beneath the aerial structure and installation of landscaping, as required. All subsequent construction work would be performed on top of the completed aerial structure with materials supplied by rail vehicles.

#### **Mitigation Measures**

To reduce the Proposed Project's impacts on Central Park the following mitigation measures are suggested:

- In advance of construction, BART would relocate and replace the two affected softball fields at another location within the park to be developed in consultation with the City of Fremont. One potential solution would be to relocate the facility approximately 200 feet to the north into what is now a parking area, and replace the parking along the

### 3.7 Fremont Central Park

BART alignment and in the area between the existing and relocated softball fields. Depending upon the timing of construction with respect to the softball season, this could eliminate the adverse impacts on recreational softball.

If the fields cannot be replaced in a timely manner, BART would work with the softball leagues to identify temporary replacement fields, if available, and lease them on a short term basis to allow league play to continue uninterrupted.

- If the softball fields are relocated into the existing parking areas northeast of the fields, temporary parking would be provided during construction. Access across the BART construction zone between the parking lots for the softball fields and the fields would be provided whenever games are scheduled.
- BART would work with the City and sailing clubs to establish new temporary and permanent sailing race courses on Lake Elizabeth.
- Temporary walking paths around Lake Elizabeth would be created and maintained throughout the construction period. The walking paths would be well signed and any paths closed for public safety and security reasons should also be well marked. At least one public pathway across the construction zone near Lake Elizabeth would be maintained at all times in order to accommodate people who walk or ride bicycles to the park from the residential areas immediately east of the UPRR corridor.
- BART and the construction contractor would work with the Alameda County Flood Control and Water Conservation District to develop and implement a program to maintain Lake Elizabeth's flood control function or provide alternative temporary storage, if necessary, during the construction period.

Mitigation measures applicable to Central Park in conjunction with the Proposed Project are also noted in other sections of this report, (e.g., Hydrology, Ecosystems, Visual, and Noise), and would also serve to reduce the project's impacts on the park.

#### **Residual Impacts after Mitigation**

Construction of the aerial structure through Central Park would add a major new structure and regular transit train activity to the park environment, permanently changing its existing mix of structures, open space and natural areas. Although the 2.6 acres of the park that would be

### 3.7 Fremont Central Park

covered by the aerial structure would require much less land than the City's proposed new gymnasium/swim center, police building, and cultural arts center, the aerial structure would traverse a portion of the park that is intended to remain open and undeveloped. Furthermore, the aerial structure has been specifically found by the City to not be in conformance with the Fremont General Plan. Considered together with its visual, acoustic, recreational and land use impacts, after implementation of recommended mitigations the Proposed Project would result in a significant residual adverse effect on Central Park.

After mitigation, residual impacts would remain on the recreational boating activities in Lake Elizabeth. While detrimental, these would not be significant adverse environmental impacts. Similarly, the impacts of the structure and train activity on recreational walking, jogging and bicycling around the lake could be reduced to less than significant levels, but not eliminated, for the Proposed Project.

#### 3.7.3 IMPACTS OF CENTRAL PARK DESIGN OPTIONS

##### Design Option 1

**Direct Impacts.** Design Option 1 calls for the construction of the BART extension along the alignment described above but in a subway instead of on an aerial structure. Design Option 1 represents a concept preferred by the City of Fremont.

The long term, post-construction impacts of Design Option 1 would be minimal. Revegetation after closure of the cut-and cover construction trench would take several years, longer in the riparian forest area immediately east of Lake Elizabeth. Therefore, most obvious signs of the BART subway alignment beneath the park would be gone within 2 to 5 years after construction. An exception would be a single emergency ventilation shaft which would break ground about 150 feet south of the softball fields. It would consist of a concrete tower about 10 feet high and 20 feet wide. Although housing powerful ventilation fans, they would be used only during tests and for actual emergencies within the subway below. It would not normally be a source of noise or fumes.

**Cumulative Impacts.** Design Option 1 would not have any cumulative impacts on Central Park.

**Construction Impacts.** Construction impacts for Design Option 1 would be similar to, but more extensive than those for the Proposed Project. The construction zone would be wider, ranging

### 3.7 Fremont Central Park

from 50 feet wide to as much as 120 to 130 feet wide depending on the type of construction and depth. For the full length of the subway, cut-and-cover construction would be used. A trench for the construction of a concrete box structure would first be excavated to the proper depth. The walls would either be supported with temporary vertical supports or sloped back from the bottom. Use of this technique would require the wider construction zone. Some of the excavation spoils would be stockpiled nearby for backfill, another portion would be used to construct the embankment near Walnut Avenue and the remainder would be trucked to a disposal site at another, presently unknown, location.

Because of the extensive amount of excavation and forming and concrete pouring required to construct the subterranean box structure, the construction activities within Central Park would be much more intensive than for the Proposed Project and the aerial design options. Larger pieces of heavy equipment and more workers would labor with more concentrated efforts for the two-year period of the civil and structural contract.

As with the aerial structure, the two softball fields, the east arm of Lake Elizabeth and the walking paths would be disrupted at the beginning of the construction period. Since the construction zone would not have to be kept open to wait for the track laying operations in the third year, the total time for construction within the park might actually be shorter with this design option than for the aerial structures. However the two softball fields would be lost for the duration of construction and it would be more difficult to maintain pedestrian and bicycle access between the neighborhoods to the east and the park.

As with the aerial structure, the construction contract would require the contractor to employ special measures to protect the clay bottom lining of the lake and to reconstruct the lake bottom with low-permeability material during the backfilling process. Similarly, the flood control functions performed by Lake Elizabeth would have to be maintained during the construction period. This would probably be more difficult with this option than with the aerial options because of the larger excavated area within the lake.

As with the aerial structure, the final step in the construction process would be clean-up, restoration of the ground surface, and replacement of landscaping. The disrupted softball fields would be reconstructed, in their present location, at this time.

**Mitigation Measures.** To reduce the construction period impacts from the subway design option beneath Central Park the following mitigation measures are suggested:

### 3.7 Fremont Central Park

- In advance of construction, BART would work with the City and the softball leagues to identify temporary replacement fields, if available, and lease them on a short term basis to permit league play to continue at the same level during the construction period. BART would also take measures to ensure that parking is available at the two softball fields that would be separated from their existing parking by the excavated trench. A temporary lot or access across the construction zone would be provided.
- To the extent feasible, BART also would maintain pedestrian/bicycle access between the park and the neighborhoods to the east during construction of the subway.

The three other mitigation measures noted above related to the sailing activities, the walking paths and flood control functions would also apply to this design option.

**Residual Impacts after Mitigation.** Construction of the subway through Central Park would restore the park to its existing configuration, resulting in no long term residual impacts. Even with mitigation there would be minor short-term, construction period impacts on the sailing activities on Lake Elizabeth, the walking paths around the lake and the softball activities. Access across the construction zone might not be continuously available during the two-year construction period for this design option. These minor impacts, however, would not be significant adverse environmental impacts.

#### **Design Option 2A**

**Direct Impacts.** Design Option 2A calls for the construction of an aerial structure on an alignment that curves approximately 600 feet east of the Proposed Project alignment. It would not cross Lake Elizabeth (see Figure 3.7-3).

The alignment for Design Option 2A would enter Central Park from the north on an aerial structure over Stevenson Boulevard at approximately the same location as the Proposed Project. It would not turn southward as soon, and instead of passing through the infield areas of two softball fields this alignment would thread its way through the softball complex, intruding slightly into the outfield areas of three softball fields. It would then continue toward Lake Elizabeth, though the small pond north of the lake, while skirting the edge of the main body of the lake. It would cross the SPTCo railroad tracks a short distance from where the two drainage channels intersect and enter Lake Elizabeth. As it passes through the park, the bottom of the aerial structure would range from 16 feet above the existing ground level near Stevenson Boulevard

### 3.7 Fremont Central Park

and the ballfields to approximately 22 feet above the surface of the small pond. The structure would rise to cross over the railroad tracks where a clearance of 23' 6" would be attained.

As with the Proposed Project, approximately 4,400 feet of this alignment would be located within the park boundaries. It would be supported with 48 to 55 vertical supports. About 1,100 feet, or 25 percent of this alignment would be located in the undeveloped portion of the park (Central Park East) located between the SPTCo and UPPR right-of-way.

Again, like the Proposed Project alignment, the BART structure for Design Option 2A would cover about 115,000 square feet (2.6 acres) of land in the park while the proposed BART alignment would occupy about five acres.<sup>1</sup> Of this only about 1,100 square feet would be permanently occupied by the support columns while the rest of the land beneath the aerial structure would be open to public use.

This design option would not have as significant long-term effects as the alignment for the Proposed Project. While it would affect three softball fields instead of two, the effects would not be significant. The left field depth on one diamond would be shortened by 10 to 15 feet, the right field on another diamond would be shortened by up to 5 feet and the center field depth on the third field would be shortened by 5 to 10 feet. With appropriate modifications to the fencing and night-lighting systems it is expected that the ballfields could remain in use at their present locations.

The selection of Design Option 2A would not affect any of the sailing activities on Lake Elizabeth, nor would it affect the flood storage functions served by the lake.

Design Option 2A also would have no direct long-term impact on the walking path around Lake Elizabeth. The path would not cross beneath the structure, although it would extend onto the BART alignment at one location. The walking path would be within 300 feet of the aerial structure for a distance of about 900 feet. Most walkers would be this close to the trains for about 1 to 2 minutes of each lap around the lake. They could expect to experience train passings at close range every two to four laps, on an average.

Design Option 2A would avoid all impacts on the northern arm of the riparian forest area east of Lake Elizabeth, as it would cross over the SPTCo railroad tracks before reaching this area.

---

<sup>1</sup> Although longer, this option affects the same amount of park land as the Proposed Project, because it leaves the park sooner on the south side.

### 3.7 Fremont Central Park

However, by moving east into the area between the railroad tracks, this alignment could potentially conflict with the design and layout of the proposed golf course planned by the City for the northeastern Central Park area. Since the golf course has not been approved, designed, funded or built, the potential impacts on it as a result of this option cannot be quantified.

The aerial structure and the train pass-bys also would introduce a significant new visual element into open vistas available from the pedestrian paths around the lake. As noted above, the changes in the views and in the noise environment are more specifically addressed in the respective sections of this EIR. Like the Proposed Project, this design option would conflict with the City's determination that an aerial structure in Central Park does not conform with the General Plan. Although the impacts on recreational uses of the Central Park are much less with this design option than with the Proposed Project, it is nevertheless judged to have a significant adverse land use effect due to its non-conformance with the City's General Plan.

**Cumulative Impacts.** Like the Proposed Project, Design Option 2A would not have any cumulative impacts.

**Construction Period Impacts.** The width of the construction corridor, the duration of the construction period and the construction techniques for this design option would generally be as described above, for the Proposed Project. However, because of the alignment location the construction period impacts would be less disruptive.

While some of the parking near the ballfields would be temporarily lost, it is likely that all of the ballfields could remain in use during the entire construction period; the use of one field would be lost at most. All of the outfields remaining in use would probably need to be shortened by 10 to 12 feet more than would be the case once construction is completed.

**Mitigation Measures.** To reduce the impacts on Central Park from Design Option 2A the following mitigation measures are suggested:

- In advance of construction, BART would develop and implement a plan to permit the continued use of the three softball fields during construction. The plan should address the need for modification to the fences, lights and access. The changes to the ballfields would be in place when league play commences. If not all of the fields can remain in use, BART would work with the City and the sport leagues to identify temporary replacement fields, if available, and lease them on a short term basis to permit league play to continue uninterrupted.



### 3.7 Fremont Central Park

- Access across the BART construction zone between the parking lots for the softball fields and the fields would be provided whenever games are scheduled.
- Temporary diversions of the walking path around Lake Elizabeth where it intersects the BART alignment would be created and maintained throughout the construction period. Such pathways should be well signed and any paths closed for public safety and security reasons also would be well marked.
- A public pathway across the construction zone from the neighborhood to the east would be maintained during construction whenever feasible.

Mitigation measures applicable to Central Park in conjunction with this design option also are noted in other sections of this report, (e.g., Hydrology, Ecosystems, Visual, and Noise), and also would serve to reduce impacts on the park.

**Residual Impacts after Mitigation.** As with the Proposed Project, construction of the aerial structure through Central Park would add a major new structure and regular transit train activity to the park environment, permanently changing its existing mix of structures, open space and natural areas. The residual impacts of Design Option 2A after mitigation would be similar to those described for the Proposed Project except that there would be no long-term impacts on boating and fewer potentially adverse impacts on users of the paths around the lake. Like the Proposed Project, this design option would have a significant unavoidable adverse land use impact.

#### **Design Option 2S**

**Direct Impacts.** Design Option 2S calls for the construction of the BART extension along the same alignment as Design Option 2A, described above, but in a subway configuration. Like Design Option 1, this design option would conform with the City of Fremont's General Plan.

As with Design Option 1, the long term, post-construction impacts would be minimal. Since the alignment would avoid the riparian area east of Lake Elizabeth, revegetation after closure of the cut-and cover construction trench would be almost complete after several years. Following recovery of the ground surface above the subway trench, the only physical sign of the facility would be the emergency ventilation shaft a short distance south of the softball fields. As with Design Option 1, it would be about 10 feet high and 20 feet wide.

### 3.7 Fremont Central Park

This design option would not have any significant adverse long term effects on the land use and recreational values of Central Park.

**Construction Impacts.** The construction techniques used and level of activity during the construction period for Design Option 2S would be generally the same as described above for Design Option 1. However, the impacts on Lake Elizabeth, the walking paths around the Lake and on the softball fields would be less with Design Option 2S than with Design Option 1. A much smaller portion of the east arm of Lake Elizabeth would be affected. If the construction zone were 130 feet wide at this point, the encroachment into the body of the lake would be less than 30 feet. The pedestrian pathway around the lake could be maintained with a minor diversion around the construction area. There would be no construction period effects on sailing activities. However, it would be difficult to maintain pedestrian and bicycle access between the neighborhoods to the east and the park. Because the encroachment into the lake would be much smaller than with the Proposed Project or Design Option 1, it would be easier to maintain the lake's flood control functions during the construction period.

Three softball fields, rather than two, would be affected, although the encroachments into two of the playing fields would be much less than with Design Option 1. However because the construction of a subway requires a wider construction zone than an aerial structure, the impacts on the three softball fields would be greater with Design Option 2S than with Design Option 2A. It is possible that the use of one or two of the fields, but not all three, could be maintained during the construction period. This would depend on the construction methods and the width of the construction zone in this particular area. The existing parking lots near the softball fields would be severely disrupted and access from parking to all of the softball fields would be more difficult.

Design Option 2S would avoid all impacts on the riparian forest area east of Lake Elizabeth, and has the potential for only short-term impacts on the future operation of the golf course being considered for development by the City in Central Park East.

**Cumulative Impacts.** No cumulative impacts within Central Park have been identified with respect to Design Option 2S.

**Mitigation Measures.** The mitigation measures for Design Option 2A are also applicable to Design Option 2S.

**Residual Impacts after Mitigation.** Construction of the subway through Central Park would restore the park to its existing configuration, resulting in no long term residual impacts. Even with mitigation there would be short-term, construction period impacts on the softball activities and the walking path around the lake. Access across the construction zone might not be continuously available during the 2-year construction period for this option. These impacts would be short-term and minor. They would not be significant adverse environmental effects.

### **Design Option 3**

**Direct Impacts.** Design Option 3 calls for the construction of an aerial structure on an alignment that curves further east of the Proposed Project's alignment than Design Option 2A/2S. It diverges from the Design Option 2A/2S alignment in the open area between the ballfields and Lake Elizabeth and is never closer than 200 feet to Lake Elizabeth. It also avoids the small pond just north of the lake. As it leaves Central Park this alignment swings 750 feet farther to the east so that it runs adjacent to the UPRR right-of-way. It crosses the drainage channel from the east approximately mid-way between the two railroads (see Figure 3.7-3).

This alignment would require about 4,480 feet of right-of-way within Central Park as compared to 4,400 feet for the Proposed Project and Design Options 1 and 2A/2S.<sup>1</sup> Of this area, about 2,700 feet would be in the undeveloped area of Central Park East. It would require approximately the same number of vertical supports as the Proposed Project and Design Option 2, while covering a slightly larger amount of park land area (about 0.1 acre).

The alignment for Design Option 3 would have identical impacts on the softball fields as Design Option 2A/2S. Like Design Option 2A/2S, it would not affect sailing activities on Lake Elizabeth; nor would it affect the lake's flood storage capacity. This option also would have no direct effect (long term or during construction) on the walking path around Lake Elizabeth. With respect to indirect impacts, the walking path would be within 300 feet of the aerial structure and train pass-bys for a distance of about 420 feet or less than 5 percent of its 1.9 mile length. Of all the aerial options, Design Option 3 would have the least impacts on walkers, although it would still introduce a significant new visual element into open vistas available from the pedestrian paths around the lake. These effects are addressed in Section 3.8 (Visual and Aesthetic Quality) of this EIR.

---

<sup>1</sup> The total length of the Design Option is 530 feet greater than the Proposed Project.

### 3.7 Fremont Central Park

While Design Option 3, like Design Option 2A/2S, would avoid all impacts on the northern arm of the riparian forest area east of Lake Elizabeth it would have a greater potential impact on the design and layout of the golf course planned by the City for the Central Park East area because it would essentially bisect Central Park East by crossing over it to follow the UPRR right-of-way.

**Cumulative Impacts.** Design Option 3 would not have any cumulative impacts.

**Construction Period Impacts.** The width of the construction corridor, the duration of the construction period and the construction techniques for this design option generally would be as described above for Design Option 2A. The impacts would be the same as for Design Option 2A.

**Mitigation Measures.** To reduce the impacts on Central Park from Design Option 3, the following mitigation measures are suggested:

- The mitigation for potential impacts on the softball fields is the same as for Design Option 2A.
- A public pathway across the construction zone from the neighborhood to the east would be maintained during construction whenever feasible.

Mitigation measures applicable to Central Park in conjunction with this design option are also noted in other sections of this report, (e.g., Hydrology, Ecosystems, Visual, and Noise), and would also serve to reduce the project's impacts on the park.

**Residual Impacts after Mitigation.** The residual impacts for this design option would be essentially the same as for Design Option 2A, except that this design option could directly constrain the planned efforts by the City to develop a golf course in the Central Park East area.

#### 3.7.4 IMPACTS OF ALTERNATIVES 1, 2 AND 3

None of these alternatives would involve any construction or operations within Fremont Central Park nor would they affect any of the on-going activities and uses of the park.

**3.7.5 IMPACTS OF ALTERNATIVES 4 THROUGH 11**

Since the alignments of Alternatives 4 through 11 in Central Park are the same as the Proposed Project, each of the build alternatives would have the same impacts as the Proposed Project. Alternatives 4 through 11 would involve the construction of an aerial structure and the operation of BART trains through areas of Central Park, as discussed in Section 3.7.2 and shown on Figure 3.7-2. The mitigation measures suggested for these alternatives are the same as those for the Proposed Project.

The Central Park design options also apply to Alternatives 4 through 11 and the impacts and mitigations discussed in Section 3.7.3 also hold for these alternatives.

## 3.8 VISUAL AND AESTHETIC QUALITY

Visual impacts are usually evaluated in light of the aesthetic character and sensitivity of the existing environment, the nature and extent of the physical changes brought about by the project, and the visibility of these changes and their effects on the viewing public. This analysis considers these factors for the Proposed Project, the Central Park and other design options, and for Alternatives 4 through 10.

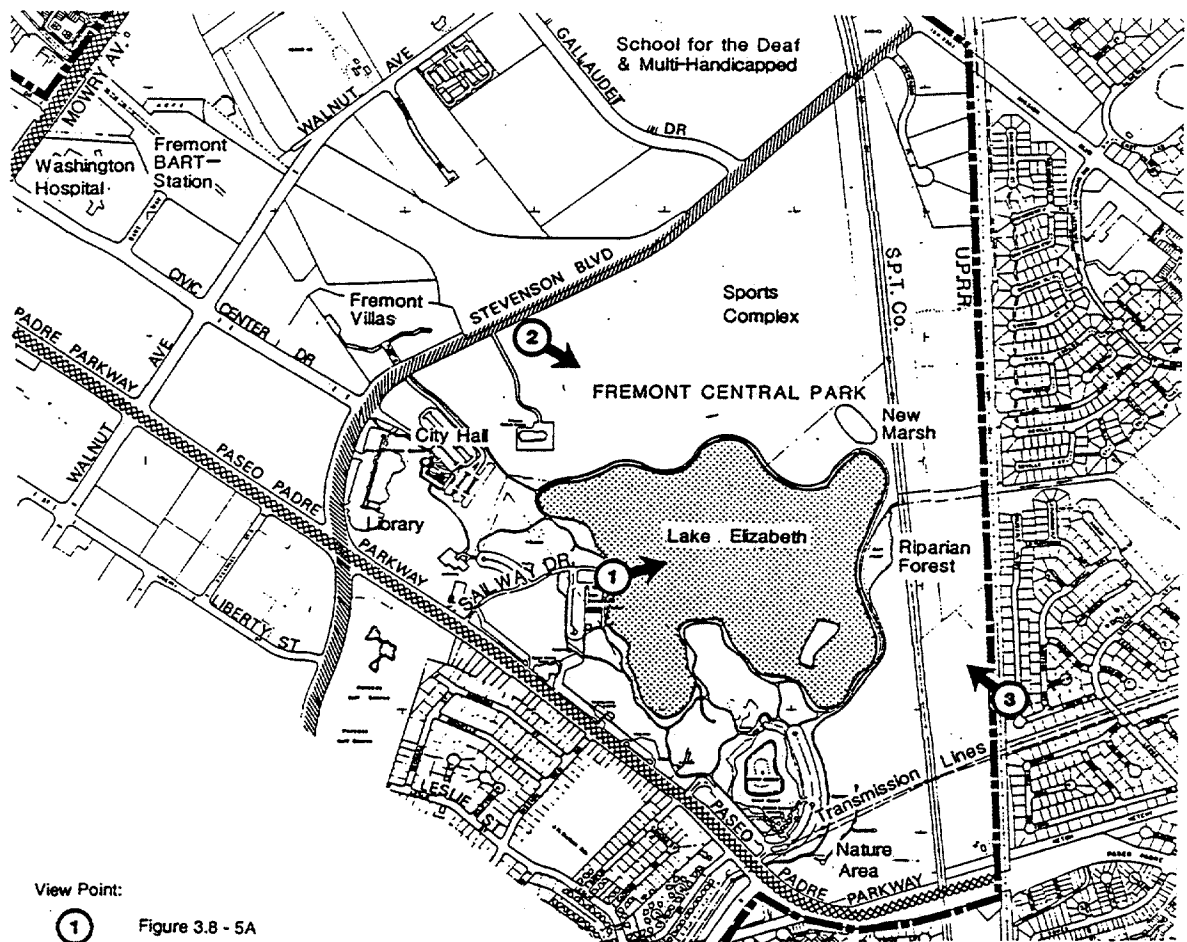
The study area has been divided into four visual analysis subareas, which are defined to encompass zones with generally similar aesthetic conditions and concerns. The four areas are: Central Fremont and Central Park (from the existing Fremont BART Station to Paseo Padre Parkway), the Irvington area (from Paseo Padre Parkway to Durham Road), the North Industrial area (from Durham Road to Mission Boulevard) and the Warm Springs/South Industrial area (from Mission Boulevard to the border between Fremont and Milpitas. The boundaries of these areas are depicted in Figures 3.8-1 through 3.8-4.

### 3.8.1 SETTING AND EXISTING CONDITIONS

#### Central Fremont and Central Park Visual Analysis Area

**Central Fremont.** The existing Fremont BART Station forms the eastern border of the area that the City of Fremont has designated as its central business district (see Figure 3.8-1). With broad streets, large distances between the buildings, and the presence of large areas devoted to parking, this area has an open, auto-dominated visual character. The area affords good views toward the hills to the east towards Mission Peak.

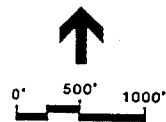
From the Fremont BART Station the alignment crosses over Walnut Avenue and across an open, undeveloped parcel, containing South Tule Pond, scattered trees and few other distinguishing visual features. Here the alignment is near the Fremont Villas condominium complex, a cluster of two-story structures containing multiple residential units. All of the units in this complex have balconies with views of the landscaped grounds. The units along the complex's north edge have views across the Proposed Project towards the hills. Under the proposed Fremont General Plan, the vacant area to the north of the alignment is designated for future development with high-density housing. As indicated in Figure 3.8-1, several of the streets in this area have been designated by the City and/or County as scenic routes, including Mowry Avenue, Paseo Padre Parkway, and Stevenson Boulevard.



View Point:

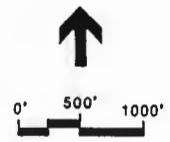
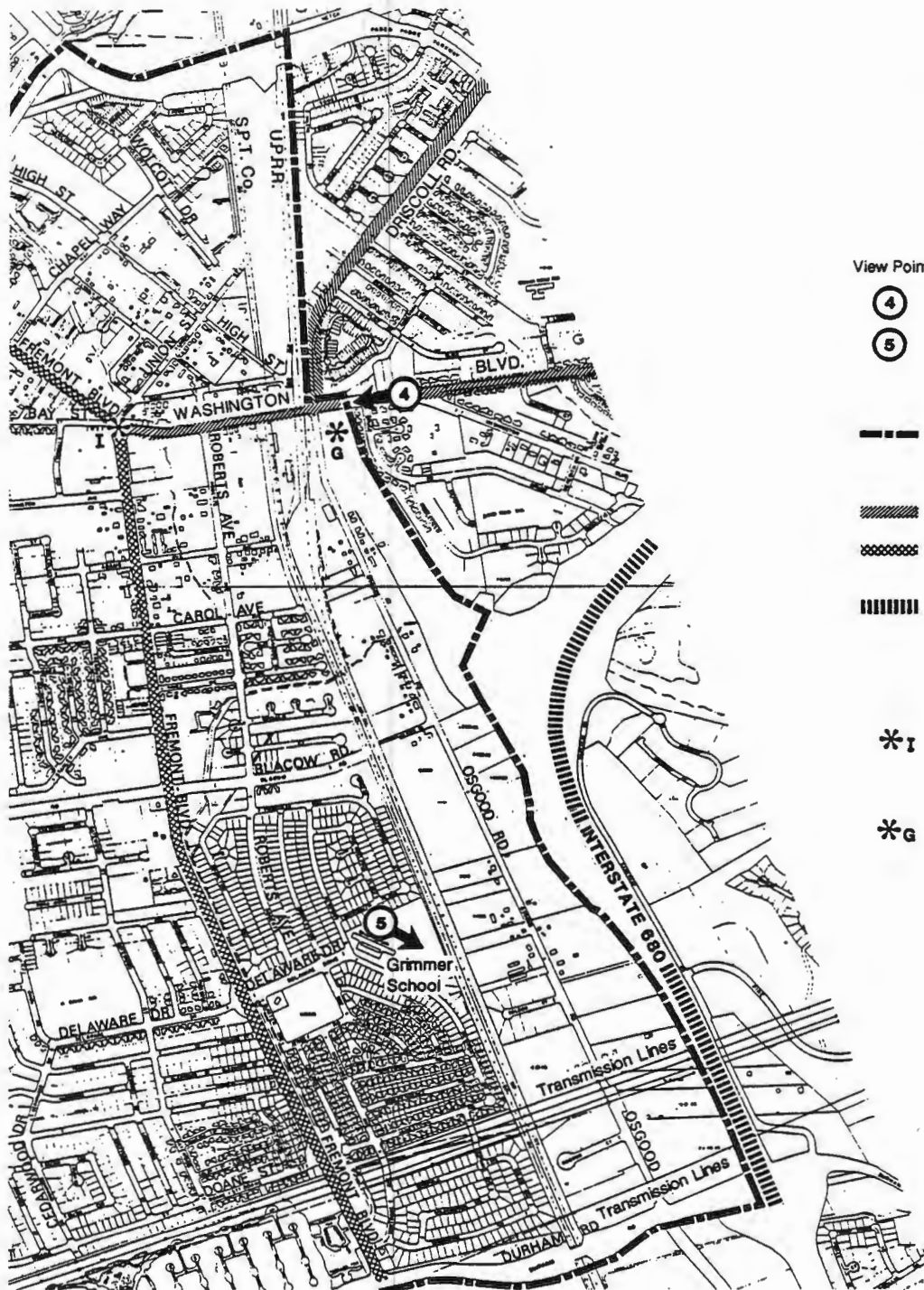
- ① Figure 3.8 - 5A
- ② Figure 3.8 - 6C
- ③ Figure 3.8 - 7A

- Boundary of City of Fremont Central Planning Area
- //// City Scenic Route
- xxxx City and County Scenic Route



**Figure 3.8-1  
CENTRAL FREMONT & CENTRAL PARK  
VISUAL ANALYSIS AREA**

SOURCE: Thomas Priestley, 1991

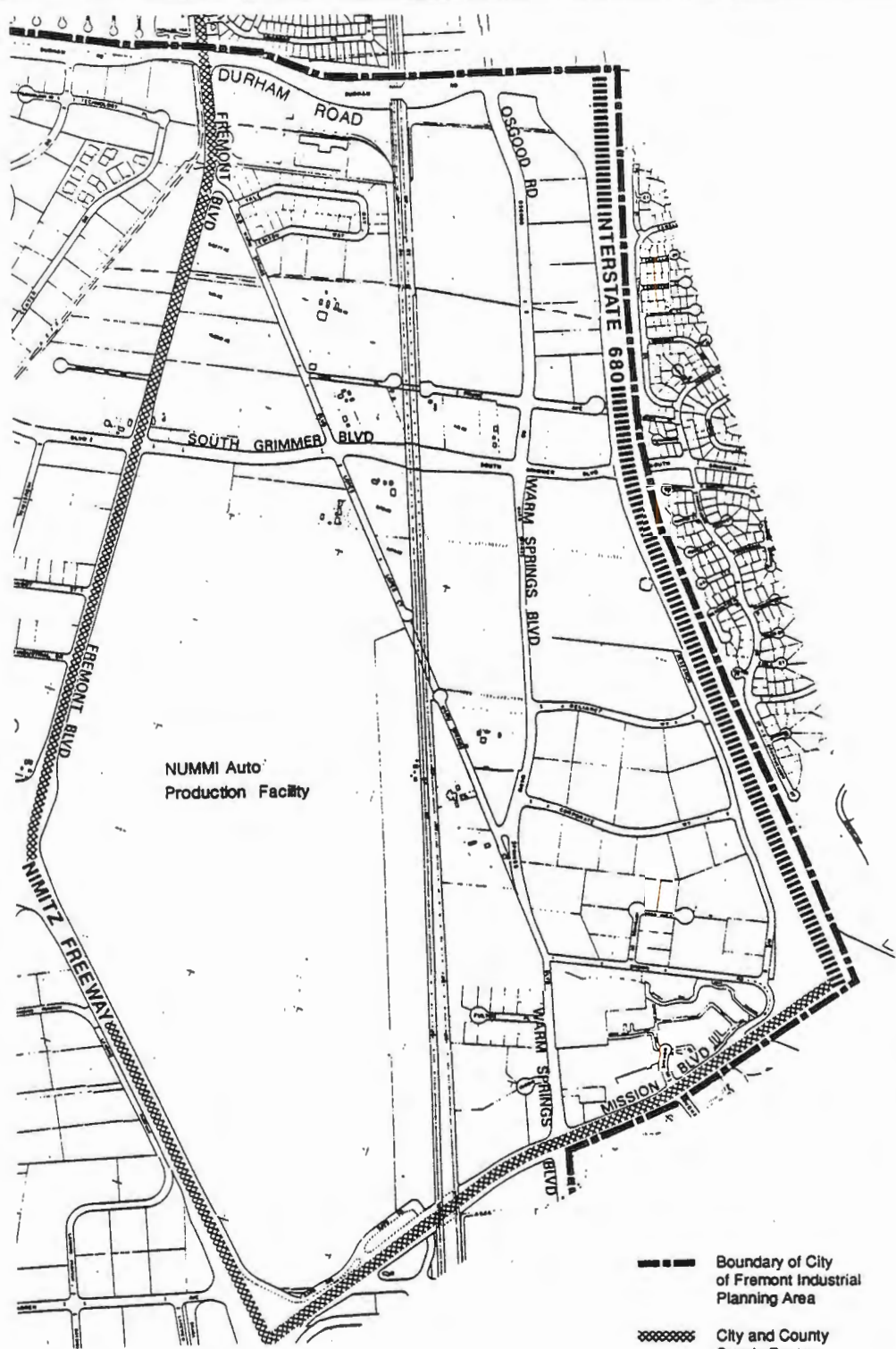
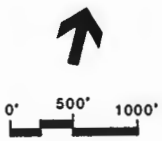


- View Point:
- ④ Figure 3.8 - 7C
  - ⑤ Figure 3.8 - 8A
- Boundary of City of Fremont Irvington Planning Area
  - ▨ City Scenic Route
  - ⊘ City and County Scenic Route
  - ▤ City, County, and State Scenic Route
  - \*I Historic Irvington Community Center
  - \*G Former Site of Gallegos Winery

**Figure 3.8-2  
IRVINGTON VISUAL ANALYSIS AREA**

SOURCE: Thomas Priestley, 1991

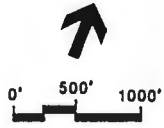




- Boundary of City of Fremont Industrial Planning Area
- ~~~~~ City and County Scenic Route
- ||||| City, County, and State Scenic Route

**Figure 3.8-3  
NORTH INDUSTRIAL  
VISUAL ANALYSIS AREA**

SOURCE: Thomas Priestley, 1991



View Point:

⑥ Figure 3.8 - 9A

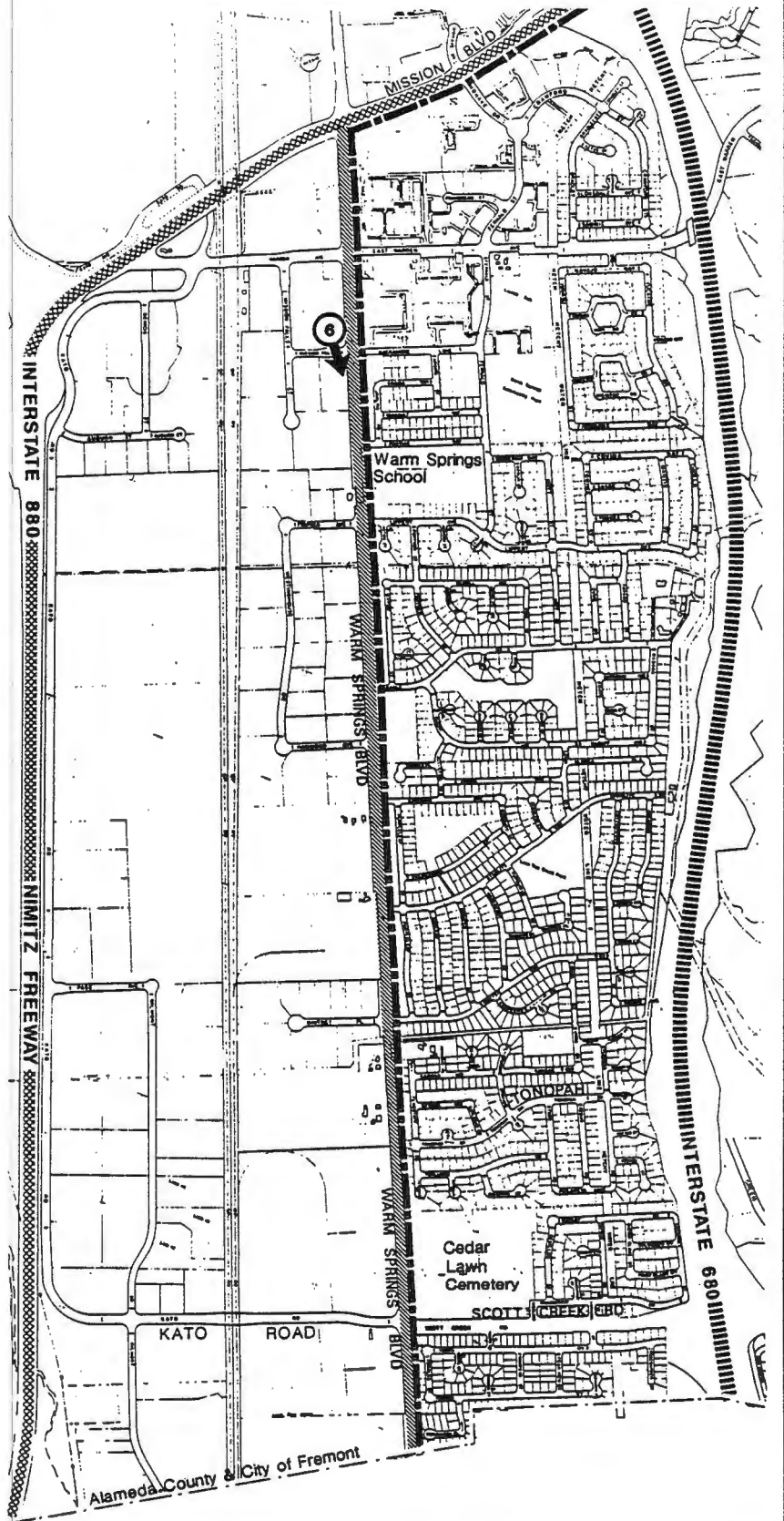
--- Boundary Between City of Fremont Warm Springs and Industrial Planning Areas

//// City Scenic Route

~~~~ City and County Scenic Route

||||| City, County and State Scenic Route

**Figure 3.8-4  
WARM SPRINGS/  
SOUTH INDUSTRIAL  
VISUAL ANALYSIS  
AREA**



### 3.8 Visual and Aesthetic Quality

**Central Park.** Central Park is described in Section 3.7 (Fremont Central Park) with major features depicted on Figure 3.7-1. The City's civic center is in the northeast corner of the park, an area which has concentration of large structures, including the visually striking Brutalist<sup>1</sup> style glass and concrete City Hall sited on a visually prominent knoll, and a large Post Modern style library building that dominates views at the intersection of Paseo Padre Parkway and Stevenson Boulevard.

The rest of the park is generally open in character. Until recently, most of the park was flat agricultural land, with relatively little natural vegetation. The few areas with significant natural plant communities include the areas of willows and other riparian vegetation at the east side of the lake and in the nature area at the park's southeast corner. The park is still being developed and landscaped, and most of the trees and shrubs that have been planted are far from mature. The open character of the park is also due to the visual dominance of Lake Elizabeth, a large artificial lagoon in the parks center. The park offers wide views towards the hills to the east (Figure 3.8-5A)<sup>2</sup> and in particular towards Mission Peak, the most prominent local landmark. Such views play an important role in establishing the park's visual character.

The lake is ringed by a wide, paved trail used for walking, jogging, and biking. There is relatively little vegetation between the trail and the lake, providing trail users with constant, unobstructed views across the water. The park's most long-established recreational areas are concentrated on the west side of the lake, where views are dominated by the lake and by the presence of the ridgeline and Mission Peak to the east. Other visible features here include the fencing and tall floodlight standards in the softball complex on the lake's north side, walls and roofs of the condominium complexes, and the School for the Deaf and Multihandicapped along Stevenson Boulevard north of the park. After dark, when the floodlights in the softball area are on, they become the most dominant element of the view. Figure 3.8-5A is representative of the daytime views toward the hills.

North of the lake, along Stevenson Boulevard, a large area has recently been developed as a sports complex. A large area between the sports complex and the lake is not yet developed, and at the east end of this undeveloped area is a small pond known as New Marsh that was

---

<sup>1</sup> The term "Brutalism" describes an architectural movement of the 1950s and 1960s that emphasized the expression of functional spaces and interior relationships in a building's exterior form and the use of monumental sculptural shapes and raw, unmolded concrete. The term comes from the French "beton brut," which refers to concrete left in its natural state.

<sup>2</sup> For comparison purposes, "before" and "after" pictures of major viewpoints are included in Section 3.8.2 - Visual Simulations.

### 3.8 Visual and Aesthetic Quality

built approximately five years ago as a detention basin for park runoff. The pond's banks are bare, but its edges are fringed with clumps of cattails and rushes. The hills and Mission Peak are the major elements of the background view from the sports complex, but the foreground and middleground views are dominated by the tall steel poles supporting the floodlight arrays, the high fencing surrounding the softball fields, and the parking areas. Figure 3.8-6C is a view into this area taken from near Stevenson Boulevard just east of the driveway into the animal shelter. This is typical of what travellers along this stretch of Stevenson Boulevard now see, and captures the view that will be seen by users of the swim center planned for this site.

The easternmost portion of the park is crossed by the SPTCo and UPRR tracks which are slightly above-grade on berms which visually contrast with their surroundings. Both railroad tracks are paralleled by utility lines carried on wood poles approximately 25 feet in height. The 700 to 1,000-foot wide corridor lying between the two railroad lines is flat and undeveloped and is now covered with low, weedy vegetation. This corridor is bisected by a deep, concrete-sided flood control channel that flows into the park from the east. An unpaved bicycle/pedestrian trail lies alongside the channel. From the backyards of the homes situated along the UPRR tracks at the park's eastern boundary, views into the park are blocked by fences and noise walls. Figure 3.8-7A is a typical backyard view in this area. In cases where homes have more than one story, there are unobstructed views into the park from the upper floors.

The area between the two railroad tracks just east of the park's nature area, is not parkland; the City designates it for agricultural use. This area and the adjacent nature area are crossed by a set of two electric transmission lines carried on 60-foot high lattice steel towers.

Central Park is heavily used by people from all parts of the community, making it the focal point of community life. Views of the park have become an important part of the City's identity. Stevenson Boulevard and Paseo Padre Parkway, the two major streets bordering the park have been designated as scenic routes. In community planning forums, Fremont citizens have expressed a strong desire to preserve the park's open character, its natural features, restrict any additional structures to the Civic Center area and the zone east of the SPTCo tracks, and limit development of additional facilities for active recreation.

#### **Irvington Visual Analysis Area**

At the north end of the Irvington analysis area, the Proposed Project alignment is located between the UPRR and SPTCo tracks (see Figure 3.8-2). The northern portion of this corridor is now vacant and open in character, and the southern portion is used as a storage area for a

### 3.8 Visual and Aesthetic Quality

building supply operation. The raised rail beds and the paralleling utility lines establish the corridor's visual character. To the east of the corridor, the area just south of Paseo Padre Parkway is developed with condominiums and single family homes. Closer to Washington Boulevard, Driscoll Road angles in close to the UPRR tracks, providing sightlines of the corridor. The area to the west of the corridor is mixed in appearance, including several multi-family residential complexes, and areas of single-family homes, some of which back up to the SPTCo tracks.

The area along Washington Boulevard in the vicinity of the rail corridor is a zone of distinctive visual character. Much of this character is related to the fact that the intersection of Washington Boulevard and Fremont Boulevard, several blocks to the west, is the historic center of the community of Irvington. The old two-story commercial buildings clustered around this intersection create a strong sense of place. The area along Washington Boulevard between this historic node and the rail corridor includes a number of older commercial structures that front directly on the street, suggesting this area's pre-suburban past. To the immediate east of the rail corridor, Washington Boulevard slopes up onto a small escarpment that marks the trace of the Hayward Fault. This escarpment provides views of old Irvington, the treetops of Fremont, and the mountains across the Bay (Figure 3.8-7C). At the base of this escarpment at Washington Boulevard and Osgood Road, there is a row of large old palm trees, a cluster of large olive trees. Caves excavated into the exposed rock of the hillside mark the former site of the Gallegos Winery, a local landmark.

South of the Washington Boulevard area, the rail corridor narrows to approximately 150 feet in width. The area to the immediate west of the rail corridor consists of several residential neighborhoods, with one-story single-family homes predominating in the area south of Carol Avenue. Within these neighborhoods, the prevailing visual character is a product of the appearance of the homes and yards, the street trees, and the views of the ridgeline to the east. Figure 3.8-8A is taken behind the Grimmer School and shows a portion of the rail corridor and depicts the full view of the ridgeline and Mission Peak provided by the playground's open space. This photo also shows the over 100-foot-tall electric transmission towers concentrated in two multiple-line transmission corridors that cross the area in the vicinity of Durham Road.

The area to the east of the rail corridor and on both sides of Osgood Road consists of large industrially-zoned parcels, some of which have been developed with moderately-sized one-story flat-roofed industrial buildings surrounded by paved parking areas, and others of which still remain vacant. At present, Osgood Road, the proposed alignment for Alternative 8, has a varied appearance, with curbs, gutters and landscaping provided in some places.

### 3.8 Visual and Aesthetic Quality

Interstate 680, whose location on the hillside to the east provides views toward the Osgood Road and the railroad tracks, is a city, county and state-designated scenic highway. Paseo Padre Parkway and Fremont Boulevard have been designated as scenic routes by both Alameda County and the City of Fremont. Washington Boulevard and Driscoll Road have been designated as scenic routes by the City.

#### **North Industrial Visual Analysis Area**

The north industrial area extends from Durham Road to Mission Boulevard (see Figure 3.8-3). In this area, the alignment for Alternative 8 generally follows the centerlines of Osgood Road and Warm Springs Boulevard, and the alignments for all of the other alternatives are located in or adjacent to the SPTCo and UPRR tracks.

The rail corridor is approximately 150 feet wide in the northern half of this area but widens south of Lopes Court to accommodate an extensive area of sidings at the New United Motors Manufacturing Inc. (NUMMI) auto production facility. This corridor's visual character is dominated by the horizontal lines of the tracks that extend off to the horizon, the light colored crushed rock of the slightly elevated rail beds and by the steel electric transmission towers alongside the corridor between Durham Road and the NUMMI plant. The area along both sides of the rail corridor has a mix of large, vacant parcels and areas devoted to new industrial and warehouse buildings. The most notable of the industrial facilities is the NUMMI auto production plant; the main plant building is several stories high and nearly a mile long and a quarter mile wide. It dominates views from the surrounding area, and in particular from Interstate 880 which lies immediately to the west of it.

The corridor along Osgood Road and Warm Springs Boulevard varies in appearance from one area to another. Near Durham Road, and near Mission Boulevard, are new industrial and commercial complexes. The roadway in these locations has been widened and upgraded with median strips, curbs, gutters, and landscaping. In between, these streets pass through land which is still used for flower growing and other agricultural activities.

From the more open portions of this analysis area, there are prominent views of the hills to the east and of the mountains across the Bay. The views of the foothills are a dominant part of the scene, and play a central role in defining this area's visual character. Fremont Boulevard, I-880, and Mission Boulevard have been designated as scenic routes by both Alameda County and the City of Fremont. Interstate 680, whose location on the hillside to the east provides views toward the Osgood Road/Warm Springs Boulevard and rail corridor alignments, is a state, county, and city-designated scenic highway. Mission Boulevard crosses both the Alternative 8

### 3.8 Visual and Aesthetic Quality

and the Proposed Project alignments. The portion of Mission Boulevard that bounds the southern edge of this area is of particular visual concern because of the views toward the hills that it offers and the large volumes of traffic that it carries.

#### **Warm Springs/South Industrial Visual Analysis Area**

This visual analysis area extends from Mission Boulevard to the County line (see Figure 3.8-4).

The SPTCo and UPRR corridor varies in width from approximately 200 feet at Mission Boulevard at this area's north end to approximately 100 feet at the Fremont/Milpitas border which defines the area's southern boundary. The corridor's visual character is dominated by the tracks and the rail beds. The area between the rail corridor and I-880 and between the rail corridor and Warm Springs Boulevard is largely industrial. The industrial developments here are relatively new, and have a usually attractive appearance based on the orderly organization of the space, and the use of trees, bermed lawns, and other landscaping to soften the outlines of the buildings and break up the expanses of parking. From the open portions of this area there are views of the hills to the east and of the mountains across the bay.

The area lying between Warm Springs Boulevard and I-680 is generally residential in character. The portion of the area closest to Mission Boulevard has a few commercial uses and a concentration of large, new multi-family complexes. These neighborhoods were laid out so that no homes fronted on Warm Springs Boulevard. The view along the east side of Warm Springs Boulevard is largely of fences along the back sides of residential properties facing the internal street network. The views toward the west from the yards that back up to Mission Boulevard are limited. Figure 3.8-9A is a view looking south on Warm Springs Boulevard, depicting the landscaped industrial parks use to the west and the back sides of the residential areas to the east. The historic Warm Springs School, a small shopping center at Gable Way, and the Cedar Lawn Cemetery provide some of the few contrasts to the almost solid line of fences along the roadway's east side. Inside the residential neighborhoods the aesthetic character is shaped by the abundance of open space provided by school yards, parks, and the Hetch Hetchy aqueduct right-of-way, and by the views of the hills to the east, and the distant mountains across the bay to the west.

Interstate 680, whose location on the hillside to the east provides views into this area is a state, county, and city-designated scenic highway. Mission Boulevard has been designated as scenic routes by both Alameda County and the City of Fremont. Fremont has designated Warm Springs Boulevard as a scenic route, but it is classified as an "industrial thoroughfare." The

## 3.8 Visual and Aesthetic Quality

roadway has four lanes and a 68-foot-wide right-of-way. Outstanding features include its "rural quality" and its "vista of hills and the Bay Region." The City's landscape guidelines for the boulevard recognize that as industry increases, more street improvements will be made, allowing the development of a landscape theme.

### 3.8.2 VISUAL SIMULATIONS

Visual simulations were developed of the Proposed Project, design options, and project alternatives as they would be seen from six selected viewpoints. The viewpoints and project conditions simulated were chosen because they either represent viewing situations of high public concern or because they represent view conditions that would occur frequently under the various project alternatives considered. The locations of the viewpoint sites are shown in Figures 3.8-1 through 3.8-4. The visual simulations (Figures 3.8-5A through 3.8-9B) are shown on the following pages.

The figures presented are based on color slides made of the digitized video images. Because of the use of control data to register the photographic image of the existing conditions with the data from the projection plan and profile drawings, the simulations illustrate the size, scale and location of the proposed structures with a relatively high degree of accuracy.

### 3.8.3 IMPACTS OF PROPOSED PROJECT

#### Criteria for Establishing Significance of Impacts

Appendix G of the guidelines for the administration of the California Environmental Quality Act (CEQA) specifies that a project can be considered to have a significant effect on the environment when it will "Have a substantial, demonstrable, negative aesthetic effect." To determine whether this project would have any demonstrable negative aesthetic effects, a procedure was used that applied the principles underlying the aesthetic analysis methods developed for use by federal agencies.<sup>1</sup>

---

<sup>1</sup> The essential characteristics of these methods are described in Yeomans, William C., 1986. *Visual Impact Assessment: Changes in Natural and Rural Environments*, Chapter 12 of Smardon, Richard C., James F. Palmer and John C. Felleman, eds., *Foundations for Project Visual Analysis*. John Wiley & Sons, New York, pp. 201-222.





**Figure 3.8-5B. PROPOSED PROJECT - SIMULATION**  
**Viewpoint 1: Sailway Drive - View Across Lake**



**Figure 3.8-5A. EXISTING CONDITIONS**  
**Viewpoint 1: Sailway Drive - View Across Lake**



**Figure 3.8-5C. PROPOSED PROJECT with LANDSCAPE MITIGATION - SIMULATION**  
**Viewpoint 1: Sailway Drive - View Across Lake**



**Figure 3.8-6A. DESIGN OPTION 2A - SIMULATION**  
Viewpoint 1: Sailway Drive - View Across Lake



**Figure 3.8-6B. DESIGN OPTION 3 - SIMULATION**  
Viewpoint 1: Sailway Drive - View Across Lake



**Figure 3.8-6C. EXISTING CONDITIONS**  
Viewpoint 2: Stevenson Blvd. near Animal Shelter



**Figure 3.8-6D. PROPOSED PROJECT - SIMULATION**  
Viewpoint 2: Stevenson Blvd. near Animal Shelter



**Figure 3.8-7A. EXISTING CONDITIONS**  
**Viewpoint 3: Valdez Way - View from Backyard**



**Figure 3.8-7B. DESIGN OPTION 3 - SIMULATION**  
**Viewpoint 3: Valdez Way - View from Backyard**



**Figure 3.8-7C. EXISTING CONDITIONS**  
**Viewpoint 4: Washington Blvd. Looking West**



**Figure 3.8-7D. ALTERNATIVES 7 and 8 (option for Alt. 6, 9 and 10) - SIMULATION**  
**Viewpoint 4: Washington Blvd. Looking West**



**Figure 3.8-8A. EXISTING CONDITIONS**  
Viewpoint 5: Grimmer School



**Figure 3.8-8B. PROPOSED PROJECT, AT GRADE ALT. - SIMULATION**  
Viewpoint 5: Grimmer School



**Figure 3.8-8C. ALTERNATIVE 7 - SIMULATION**  
Viewpoint 5: Grimmer School



**Figure 3.8-9A. EXISTING CONDITIONS**  
Viewpoint 6: Warm Springs Blvd. at Mission Falls Lane



**Figure 3.8-9B. ALTERNATIVE 8 - SIMULATION**  
Viewpoint 6: Warm Springs Blvd. at Mission Falls Lane

For areas visible from residential and passive recreation areas, the Proposed Project was judged to have significant adverse environmental effects when it would be highly visible, and would contrast with its surroundings.

Where the Proposed Project would be highly visible from active recreational areas, scenic routes, and other public areas used by large numbers of people, the project was judged to have significant adverse environmental effects.

**Direct Impacts**

**Central Fremont and Central Park Visual Analysis Area.** From the Fremont Station to south of Walnut Avenue, the Proposed Project would be on a raised embankment (see Typical A). Walnut Avenue would pass through the embankment by means of a concrete-sided underpass.

The embankment would occupy a portion of the existing Fremont Station parking lot, breaking up the view across the lot and blocking views toward the hills for users of the lot's southwest corner and travellers heading east on Walnut Avenue. The new embankment would be highly visible but because it would be consistent in scale and character with the existing features of the station site, its visual impacts would be less than significant. South of Walnut Avenue, the existing Tule Pond would be relocated to the western side of the new embankment. In the area behind the Fremont Villas condominium complex, a 4- to 7-foot high sound barrier wall would be constructed on top of the embankment on both sides of the tracks. These changes would alter the open view across the tule pond that now exists in this area, replacing it with a view enclosed by the embankment and sound walls, creating a significant visual impact.

**Factors considered in evaluating the aesthetic effects:**

*Visibility.* The extent to which the physical changes brought about by the project could be seen by the public.

*Number of viewers.* The numbers of people who could potentially see the changes brought about by the project.

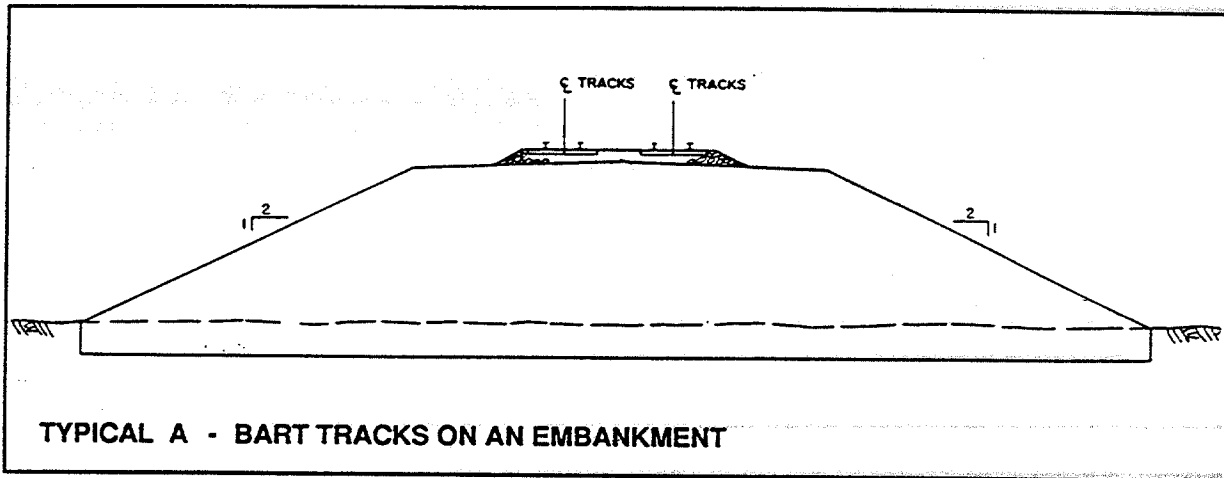
*Contrast.* The extent to which the form, line, color, and scale of the project's elements would either contrast with or be visually absorbed by the setting's existing features.

*Dominance.* The extent to which the project elements would dominate the view.

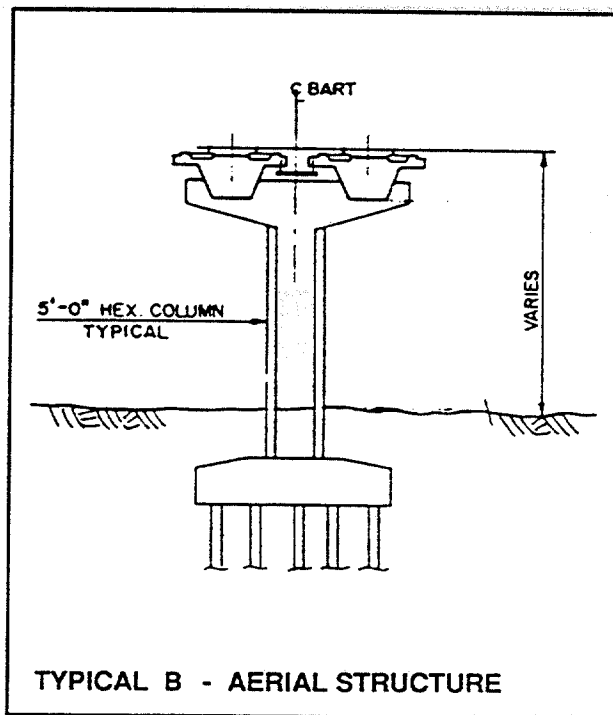
*Character.* The extent to which the changes would be compatible with the character of the setting. It was assumed that the project facilities would be most compatible with industrial and commercial settings and least compatible with residential and passive recreation settings.

*Community policies.* The extent to which the changes would be compatible with the aesthetic policies and guidelines established in locally adopted plans.

### 3.8 Visual and Aesthetic Quality



The embankment would terminate with a concrete abutment, and the alignment would continue on an aerial structure varying in height from 15.5 to 23.5 feet (see Typical B). The apparent height of the aerial structure would be increased by the addition of sound barrier walls that would extend approximately three feet above the elevation of the track. The columns supporting the aerial structure would be approximately 70 to 80 feet apart. The aerial structure would travel across the vacant land behind the Fremont Villas condominium complex and cross Stevenson Boulevard and Central Park to Paseo Padre Parkway. The structure would pass within 40 feet of the Fremont Villas condominium complex. Residents living in units on the north side of this complex, as well as many of the residents of the high density housing that could be built in the future on the now vacant land on the east side of the alignment would have close views of the aerial structure and of the passing trains. The visual impact in this area would be significant.



The aerial structure would have a significant impact on views from Stevenson Boulevard, a scenic route. It would be visible to travellers from both the east and west at the road crossing, and through Central Park. Figure 3.8-6D simulates the change in the view created by the

### 3.8 Visual and Aesthetic Quality

Proposed Project as viewed from the portion of the park adjacent to Stevenson Boulevard at Animal Shelter Drive. The aerial structure would be a dominant visual element when viewed from close range; when viewed in the mid-distance, it would tend to reduce the sense of the park's openness. Except in cases where it is in the immediate foreground of a view, the aerial structure would not have a significant effect on views of the ridgeline or of Mission Peak. Although the aerial structure would be bulkier than the built elements that now exist in the sports complex area, it would not be out of scale with the floodlight standards or the snack bar structure in the softball complex. Plantings in this area would provide a modest level of screening. In spite of these contextual factors, visual impacts would be significant in this area.

The aerial structure would be most visible and have the greatest impacts as it passes along the northern edge of Lake Elizabeth and across the lake's eastern arm. In this area, there is relatively little vegetation to screen the structure from the view of the large numbers of people using the lake and the areas immediately adjacent to it. Figure 3.8-5B depicts the change that the Proposed Project would make to the view across the lake from the end of Sailway Drive. From this vantage point, the aerial structure would be a highly visible element in the view, but would not be dominant. It would be most apparent where it crosses the arm of the lake, partially blocking the view to the lake's easternmost shore. To some degree, the portion of the structure north of the lake would be visually absorbed by the background vegetation.

To the south of the lake, the visual impacts would not be as highly significant because the structure would be screened to a large extent by the riparian forest's thick vegetation, although passing trains would probably be visible. The aerial structure would not have significant impacts on views from the portion of Paseo Padre Parkway passing along the park's west edge because of the structure's distance from the roadway and because of the screening provided by the trees and structures located on the lake's west side.

The aerial structure's most severe and significant visual impacts would be in close-at-hand views from the walkway at the east side of the lake. Here, the structure would be visually dominant in near views. In addition, construction of the structure would require a corridor to be cut through the riparian forest around the silt pond, opening up a view that is now enclosed by natural vegetation, and introducing a bulky, constructed form into what is now a naturalistic scene.

South of the riparian forest area, the aerial structure would pass behind the natural vegetation where it will be nearly completely hidden from the park's developed areas. As it passes through the non-park vacant parcel east of the nature area, the structure would pass under the pair of



### 3.8 Visual and Aesthetic Quality

high voltage transmission lines. To maintain the clearances required by the California Public Utilities Commission, the height of the lines would probably have to be increased, requiring the towers on both sides of the aerial structure to be replaced with taller structures. The taller towers would be more readily visible to viewers in the park and in the adjacent neighborhood. In addition, the contrast in size between the new towers and the rest of the line's structures could be visually discordant. If towers that are considerably taller than those that now exist were required, the impacts would be significant.

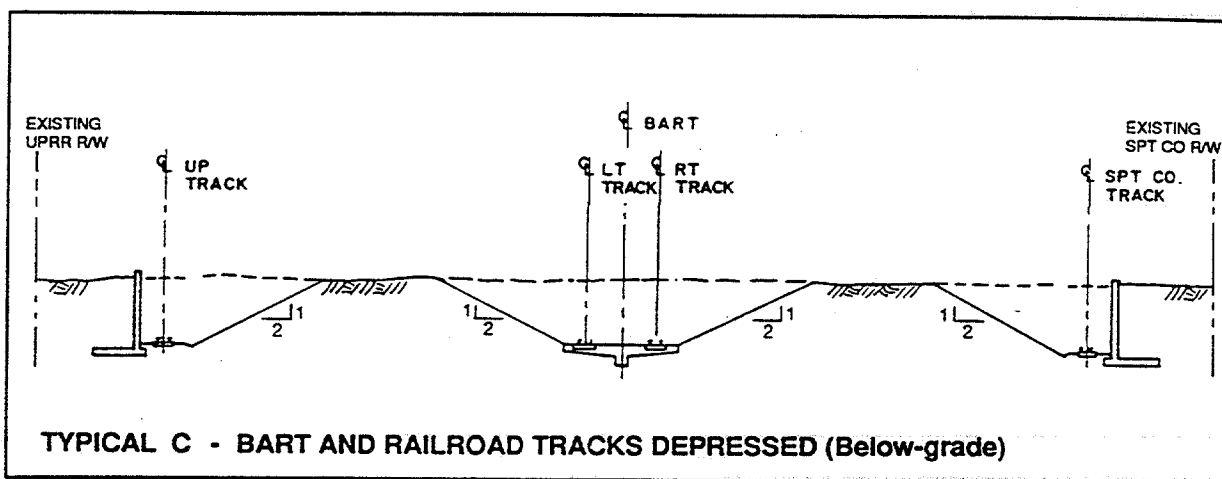
Where it crosses Paseo Padre Parkway, the aerial structure would be highly visible to travellers as they approach and pass under it. It would also add to the visual clutter associated with the existing at-grade rail crossings and would dominate views from the parkway. Because its construction would require cutting a corridor through the vegetation bordering the north side of the road, the structure would open up views into this area. Overall, the structure's visual impacts in this area would be significant.

In this visual analysis area, BART's routing on raised embankments and aerial structures would provide passengers with unobstructed views of central Fremont, the School for the Deaf and Multihandicapped, Central Park, Lake Elizabeth, the Fremont Civic Center, and the eastern ridgeline and Mission Peak.

**Irvington Visual Analysis Area.** Between Paseo Padre Parkway and Washington Boulevard, the alignment would travel down the middle of the railroad corridor. After crossing Paseo Padre Parkway, the aerial structure would begin to descend, reaching the ground elevation at a point about 1,200 feet south of the road, where the tracks would pass onto a depressed road bed that would incline down to 20 feet below the ground surface at its deepest point. In this area, the existing UPRR and SPTCo trackbeds would be rebuilt so that they would slope down into uncovered, below-surface concrete-lined corridors. Typical C is a cross-section of the proposed subsurface treatment of the BART line and the railroads in this area. At Washington Boulevard, BART and the railroad roadbeds would be deep enough to permit the street to remain at its current elevation as it crosses over them.

The sloping segment of the BART structure between Paseo Padre Parkway and the depressed roadbed would be visible from many of the residences on both sides of the railroad corridor, but because views would be partially blocked by the existing sound walls, the visual impacts in this area would be less than significant. From Driscoll Road, the commercial buildings and storage yards that can now be seen along the corridor would be removed and replaced with open views across the tops of the depressions containing BART and the railroad lines. This

### 3.8 Visual and Aesthetic Quality



would create an impact that would be significant because it would be a major change visible to large numbers of viewers.

Removing the at-grade railroad crossings that now exist at Washington Boulevard would create some improvement in views in this area. A photograph of existing conditions (Figure 3.8-7C). Railroad crossing signals above the roadway would no longer be necessary, and the UPRR and SPTCo tracks and the proposed BART line would not be visible.

The Irvington Station would be located just south of Washington Boulevard. Its general layout is depicted in Figure 2-3. The station's platform would be below ground, but its concourse structure, loading area, and parking would all be at surface level. From Washington Boulevard southward for approximately 1,000 feet, the subsurface BART and railroad tracks would be covered, and portions of the concourse structure, bus loading area, and passenger drop off area would be built on top of them.

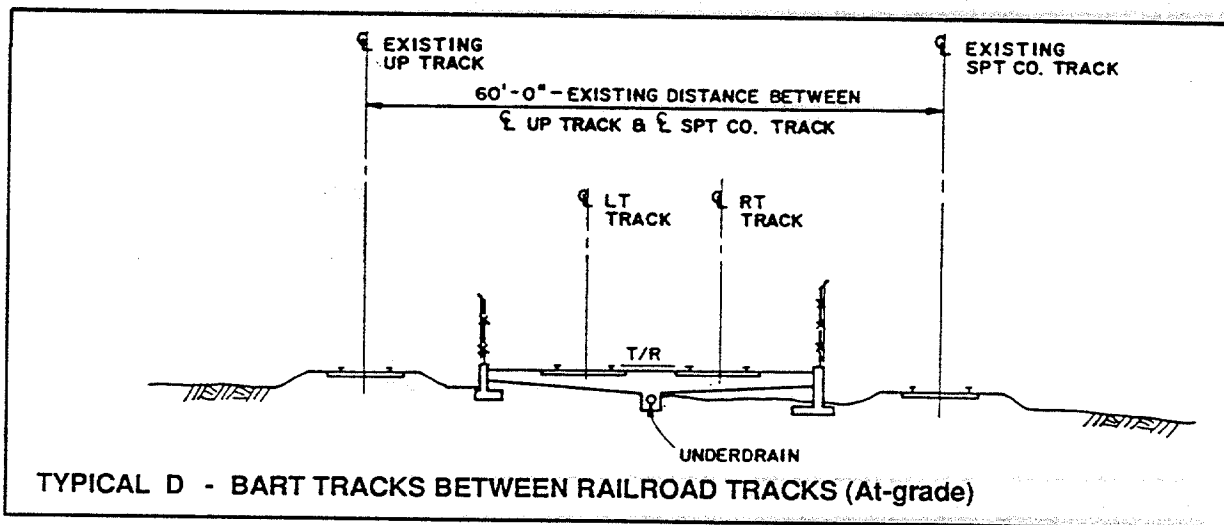
At this point in project design, the visual and aesthetic effects of the station can only be evaluated in general terms. However, the station would significantly change this area's appearance due to the removal of the lumber yard's structures, as well as the piles of material and the at-grade railroad tracks and crushed rock roadbeds that now exist in the railroad corridor. These facilities would be replaced with a concourse structure set in the middle of a large, slightly elevated open area devoted to driveways, parking, pedestrian circulation areas, and landscaping. The appearance of the now vacant area at the base of the hill east of Osgood Road would be altered by the construction of parking lots, and the addition of the pedestrian bridge and landscaping. The pedestrian bridge would be highly visible to travelers along Osgood Road. Depending on its final design, the station could have either positive or significant

### 3.8 Visual and Aesthetic Quality

negative impacts. The layout of this area would provide for preservation of the wine cave ruins and large palm and olive trees that serve as reminders of the Gallegos Winery which once occupied the site.

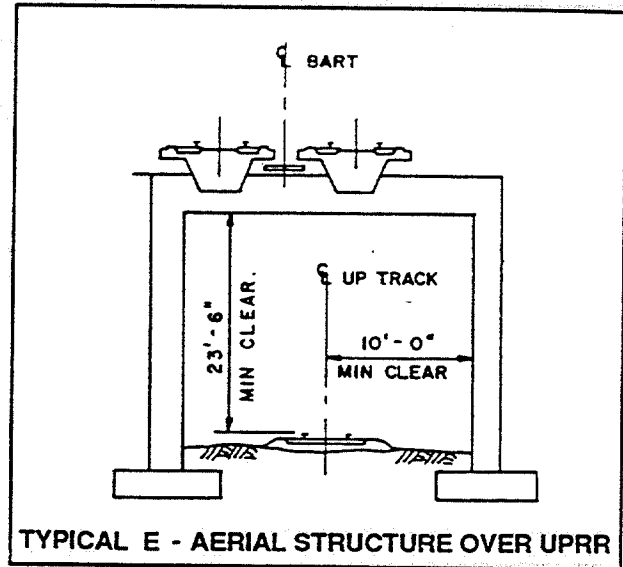
South of the Irvington Station, the BART tracks and the railroad tracks would re-emerge at the ground surface, and continue at grade to the end of the Irvington visual analysis area at Durham Road. In this area, the BART tracks would be built on a slightly raised roadbed located between the UPRR and SPTCo tracks. Seven-foot-high sound barrier walls would be built on each side of the BART alignment. Typical D illustrates the potential relationship between the BART line and the railroads in this area.

Figure 3.8-8B depicts the appearance of the line and sound walls as viewed from the area behind the Grimmer School. In general, the at-grade tracks and sound walls would not have a significant visual impact. From most of the residential backyards that adjoin the rail corridor, views would be substantially screened by existing backyard fences. The sound walls will be visible from open areas such as the playfield behind the Grimmer School and open lands in the industrial area to the east of the rail corridor. From most vantage points the walls will be visible but will not significantly alter existing views.



Since BART would be depressed, passengers would not be able to see much, if any, of the historic Irvington community, the Gallegos Winery site, or the fault escarpment east of the Irvington Station. In the at-grade segment of the route between the Irvington Station and Durham Road, passengers would mostly see the sound walls located immediately adjacent to the roadbed, particularly on the west side.

**North Industrial Visual Analysis Area.** About 500 feet south of the Durham Road overpass, the Proposed Alignment would travel up an inclined embankment and pass onto an aerial structure with two rows of supporting columns (Typical E). This structure would rise up to height of over 35 feet at one point to permit the BART tracks to cross over the UPRR tracks to an alignment along the eastern edge of the rail corridor. After crossing Grimmer Road, the height of this aerial structure would drop to approximately 15 feet at the site of the proposed Warm Springs Station.



The Warm Springs Station would be developed on the large vacant parcel lying between the rail corridor and Warm Springs Boulevard immediately south of Grimmer Boulevard. Its general layout is depicted in Figure 2-4. The site, now open agricultural space, would be dominated by the large, landscaped parking lots, and the elevated track and station platform. However, the scale and character of the changes to the site would not contrast with the scale and character of the industrial facilities that now exist or that may soon be developed in the surrounding area, and the station would probably not create a significant negative visual impact.

South of the Warm Springs Station, the aerial structure would slope downwards and the tracks would pass onto an at-grade roadbed that would be located along the eastern edge of the UPRR right-of-way, and the BART alignment would continue at-grade to the southern border of this visual analysis area at Mission Boulevard. The primary visual consequence of the Proposed Project in this area would be removal of some of the trees and other landscaping that now exists along the edge of the railroad corridor at the back sides of the abutting industrial parks. In this area, because the proposed facility would be seen by relatively few viewers and would be consistent with the character of the rail corridor in which it is located, it would not create a significant negative visual impact.

In this visual analysis area, the elevated section of the route crossing Grimmer Road and at the Warm Springs Station would provide passengers and station users with views over nearby industrial facilities, including the massive New United Motors Manufacturing Inc. (NUMMI) complex, and panoramic views of the ridgeline and Mission Peak to the east and the Bay and

### 3.8 Visual and Aesthetic Quality

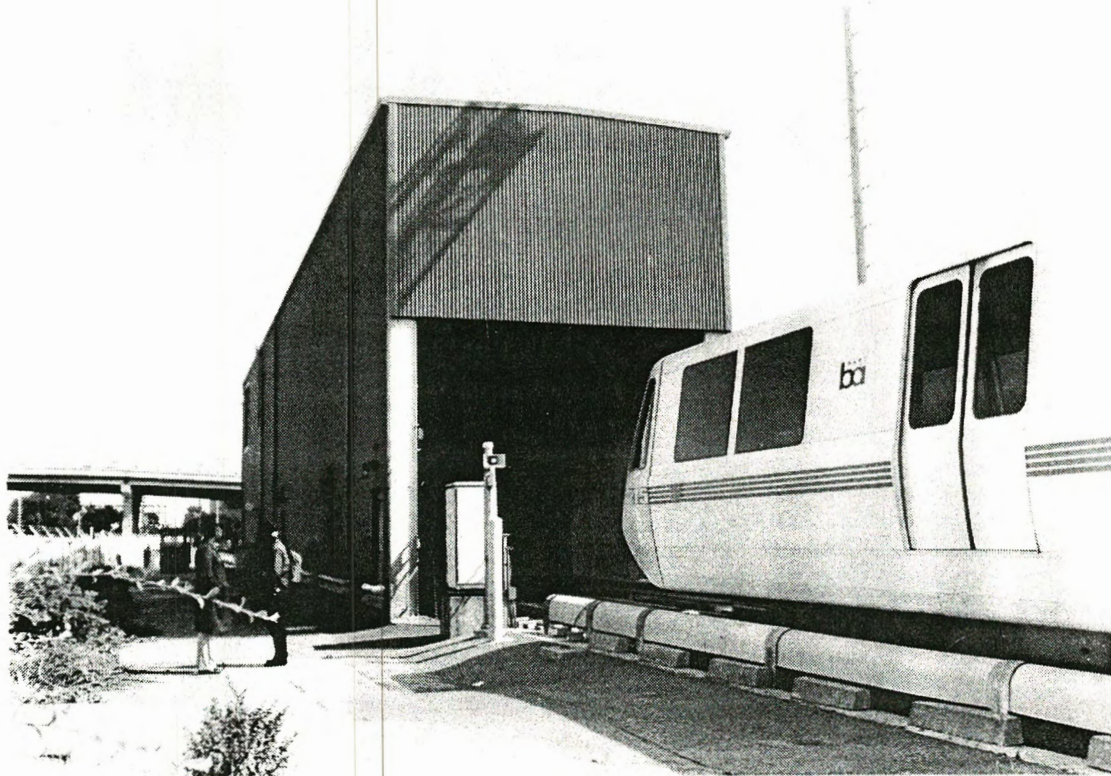
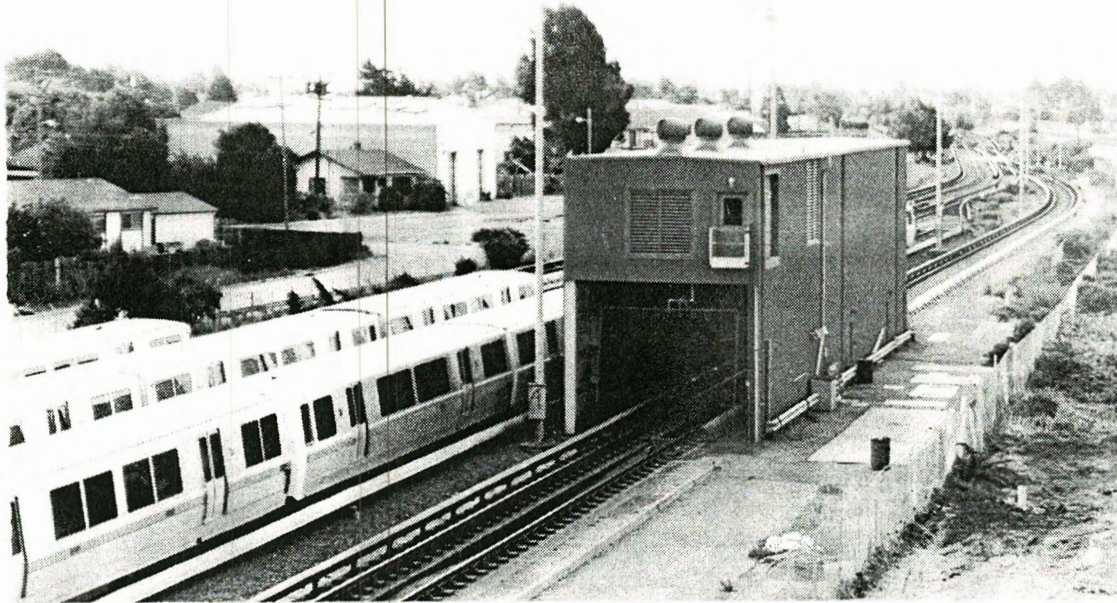
Peninsula ridgeline to the west. In the at-grade section to the south of the Warm Springs Station, passengers would have ground level views of the NUMMI complex to the west. When breaks in the sound walls to the east permit, passengers would have views of the back sides of the industrial parks that front on Mission Boulevard.

**Warm Springs/South Industrial Visual Analysis Area.** Throughout the length of this visual analysis area, the BART tracks would be located at-grade along the eastern side of the UPRR right-of-way. In a number of areas where the alignment passes in close proximity to buildings, seven-foot-high sound barrier walls would be built along the edge of the tracks. (For a precise identification of these areas, see Section 3.13, Noise and Vibration.) Along this section of the Proposed Project, the visual impacts would be related to the removal of several industrial and commercial buildings, including landscaping. Overall, this segment of the line would not create a significant visual impact.

The South Warm Springs Station would be located toward the southern end of this visual analysis area, just south of Whitney Place. The station's general layout is depicted in Figure 2-5. The station's platform would be slightly elevated above the ground surface, and the concourse would be built under the platform in an area that would be excavated out. Areas for parking, circulation, drop-off, and landscaping would all be developed at grade. Just south of the concourse and platform, a seven-foot-high sound wall would extend for several hundred feet along the west side of the tracks. At the southern end of the property, near Kato Road, a rail car wash structure that would be approximately 25-feet high and 200-feet long would be constructed over the western track. This structure will be similar in appearance to the BART car wash structures that now exist at the District's Richmond and Hayward rail yards (Figure 3.8-10). A small emergency maintenance/inspection pit would be constructed on east side of storage track area.

Because no architectural or landscape plans are now available for the station and its site, their aesthetic effects can only be evaluated in general terms. The station site is now an open vacant lot. The visual changes related to the station would not be readily apparent from Warm Springs Boulevard because the views into the site would be screened by the large industrial buildings that lie between the boulevard and the site. Depending on the details of the station final design, the visual impacts may or may not be significant.

The area between Kato Road and the project's terminus at the Alameda/Santa Clara County line would contain a set of at-grade storage tracks that would be generally similar in appearance to the other at-grade segments of the line. The storage track area would not be particularly



**Figure 3.8-10**  
**EXISTING BART CARWASH FACILITY IN THE RICHMOND YARD**

SOURCE: Donaldson Associates, 1991

### 3.8 Visual and Aesthetic Quality

visible from Warm Springs Boulevard, Milmont Drive or I-880. Because of the limited views into this area the visual changes would not create significant impacts.

Because of BART's at-grade location in this visual analysis area, passengers would have ground level views, primarily of sound walls and the back sides of the industrial parks on both sides of the alignment. The aerial option over Mission Boulevard and Warren Avenue would provide passengers panoramic views over the nearby industrial facilities, including NUMMI, and vistas toward Mission Peak and the ridgeline to the east, and toward the Bay and the Peninsula ridgeline to the west.

#### **Cumulative Impacts**

Over the life of the project, most of the now-vacant and underutilized areas along the alignment are likely to be developed for residential, commercial, industrial, and community use. In general, the result of this additional development will create an environment that is more built up, and as a consequence, the BART aerial structures are less likely to contrast with or dominate their surroundings. Even in Central Park, the proposed swim center and public safety building near the alignment at the park's north end will create a scene within which the BART aerial structure would appear relatively compatible. Other development in the park, and the establishment of additional plantings and the maturing of existing plants will all contribute toward making the park a more visually complex environment that is more capable of visually absorbing the proposed BART structures.

#### **Construction Period Impacts**

**Central Fremont and Central Park Visual Analysis Area.** During the construction period, the presence of heavy equipment, the disturbance of the ground surface, and the presence of the incomplete embankment and aerial structure would create temporary visual disturbances in the parking lot at the south end of the Fremont Station and in the now undeveloped area between Walnut Avenue and Stevenson Boulevard. The impacts would be significant in the area between Walnut Avenue and Stevenson Boulevard.

In Central Park, the building of the aerial structure would create temporary but significant visual impacts. The construction would require the use of heavy equipment that would by itself be visually intrusive, and which would also cause damage to planted areas, exposing bands of bare soil that would visually contrast with their surroundings. Construction of the lake crossing would require a coffer dam across the east arm of the lake, and that as well as the construction

### 3.8 Visual and Aesthetic Quality

equipment and activities would be visually prominent to many park users. The coffer dam would wholly or partially dry up the eastern arm of the lake, temporarily changing that area's appearance. Some of the most significant construction period visual impacts could occur in the area of riparian vegetation around the siltation pond. Here, clearance of a corridor for the aerial structure and the presence of the heavy construction equipment in the immediately surrounding area could lead to destruction of a large percentage of the existing vegetation and unsightly disturbance of the ground. These effects would be most visible to visitors using nearby portions of the trail around the lake, but the disturbance of the lake's existing vegetative backdrop would also be noticeable to visitors elsewhere around the lake.

East of the nature area, construction of the aerial structure and replacement of the transmission line towers would cause some temporary removal of vegetation, but would not be as readily visible and would not be as significant.

**Irvington Visual Analysis Area.** In the area between Paseo Padre Parkway and the Irvington Station, excavation for the depressed sections of the BART line and the two railroads would necessitate the presence of heavy equipment and lead to considerable ground disturbance. In addition, if temporary on-site storage of excavated materials were required, there would be piles of soil and rock that would be visible from the surrounding residential areas and Driscoll Road, creating a temporary but significant visual impact.

The excavation activity would also cause temporary disturbance of views down Washington Avenue and of the site to be occupied by the Irvington Station. The plan to use material excavated from the station site to raise the elevation of the parking areas adjacent to the station and to the east of Osgood Road could lead to the presence of temporary spoil piles and to the temporary existence of graded but unpaved and unvegetated ground surfaces. Given this area's visibility, the construction period visual impacts would be significant.

Construction of the at-grade segment of the line between the Irvington Station and Durham Road would require the temporary presence of heavy construction equipment, and could produce some ground disturbance. However, because much of this portion of the corridor is already screened from view, the construction period visual impacts in this area would not be significant.

**North Industrial Visual Analysis Area.** Construction of the BART line itself would require the temporary presence of heavy equipment and would lead to the short-term existence of incomplete aerial structures. The visual effects of the construction period activity would be



### 3.8 Visual and Aesthetic Quality

attenuated by the fact that it would be confined to the rail corridor and that it would not contrast in scale and character with the surrounding industrial land uses. As a consequence, the construction period impacts would not be significant. The development of the station site could be of visual concern and create a visual impact during this period if large areas of bare earth were exposed for any considerable length of time while being prepared for paving and landscaping.

**Warm Springs/South Industrial Visual Analysis Area.** In this area as in the North Industrial Visual Analysis area, the process of constructing the BART line itself would produce no significant visual impacts because of the confinement of the construction activities to the rail corridor and because of the industrial character of the surrounding land uses. Because the South Warm Springs Station site is not very visible from Warm Springs Boulevard or other heavily travelled streets, construction activities on the site would not be of significant visual concern.

#### **Mitigation Measures**

**Central Fremont and Central Park Visual Analysis Area.** To reduce the impacts of the embankment that would be built in the Fremont Station parking lot and in the undeveloped area between Walnut Avenue and Stevenson Boulevard, BART would establish plantings on the embankment's sides that would provide visual interest and soften the embankment's appearance.

In the area between Walnut Avenue and Stevenson Boulevard, BART would plant groups of fast-growing evergreen trees along the east side of the embankment and along the east and west sides of the aerial structure to screen views from and into the Fremont Villas condominium complex and the additional residential complexes that are likely to be built nearby in the future.

At the aerial structure's crossing of Stevenson Boulevard, clumps of evergreen trees would be planted adjacent to the structure on both sides of the road. The tree masses would limit the extent of the structure visible in the front field of view of people travelling on the boulevard, and would partially screen long views down the alignment as seen from the road. BART would work closely with the City of Fremont on the layout and design of the swim center and public safety building to identify ways that the facility could be designed to reduce foreground views of the aerial structure from its outdoor use areas. The design of the facility structures and landscaping could be made compatible with the forms of the aerial structure and ways they could be sited to screen the aerial structure in views from Stevenson Boulevard.

### 3.8 Visual and Aesthetic Quality

BART would work with the City of Fremont to develop a landscape plan for the recreation complex and the now vacant area on the north shore of Lake Elizabeth. The plan would avoid creating a densely planted corridor immediately adjacent to the aerial structure. Instead, groups of plantings would be strategically sited throughout the area north of the lake to visually define and aesthetically enrich the various use areas, while at the same time providing screening for near and more distant views toward the structure. Figure 3.8-5C simulates a possible landscaping treatment as mitigation.

For the crossing of the lake, BART would undertake detailed design studies to reduce the numbers of columns sited in the lake and to assure that the required columns are placed in a way that minimizes undesirable aesthetic effects.

In the riparian forest, BART would manage its construction activities in a way that minimizes the need to disturb the existing vegetation and soil. At the completion of the construction process, the natural vegetation in this area would be restored as quickly as possible, both around and under the aerial structure.

In the area between the two railroad tracks that lies east of the nature area, the primary mitigation measure would be to restore the ground surface and naturally occurring vegetation. In addition, tall, dense plantings would be established on both sides of the structure along the north side of Paseo Padre Parkway to minimize the portions of the aerial structure that could be seen from the road.

**Irvington Visual Analysis Area.** At the north end of the rail corridor just south of Paseo Padre Parkway, dense plantings would be established to screen views of the elevated structure from the parkway and the surrounding residential areas. Additional landscaping would be provided in the public right-of-way along Driscoll Road, just north of Washington Avenue to provide additional screening of views into the rail corridor.

In developing its detailed architectural and landscape plans for the Irvington Station, BART would collaborate closely with the City of Fremont to assure that the final designs are consistent with the City's design objectives for this area to the extent that this is possible. In preparing the final plans for the portion of the station site east of Osgood Road, BART would take special care to preserve the old Gallegos winery site and ruins, and the palm and olive trees, and to the extent feasible, make them featured elements of the design. The plant palette used for landscaping the site would emphasize species that reinforce the area's historic character.

### 3.8 Visual and Aesthetic Quality

Within the parking areas, internal landscaping would be provided to visually divide the expanses of paving, to provide shade, and to provide protected circulation areas for pedestrians.

To reduce the construction period impacts, the excavation and grading activities would be programmed to allow the excavation and grading to be accomplished as quickly as possible, and to be followed immediately with paving and landscaping.

In the area between the Irvington Station and the end of the Irvington visual analysis area, no special visual mitigation measures are required.

**North Industrial Visual Analysis Area.** In this visual analysis area, no special visual impact mitigation measures are required for either the at-grade or elevated portions of the line. However, BART would give special attention to the detailed designs for the Warm Springs Station. The design of the concourse and platform area would make reference to and be compatible with the major industrial buildings in the surrounding area. In addition, the design of the concourse and platform area would maximize views toward the hills to the east and west. Attention would be given to the relationship between the site and Warm Springs Boulevard, where landscaping and curb, gutter, and sidewalk treatment along the site's Warm Springs Boulevard frontage would complement the City's plans for this area. Landscaping would be provided within the parking areas to visually break up the expanses of paving, to provide shade, and to provide protected circulation areas for pedestrians. The parking area landscape treatment would also be designed to create a scene that is pleasing when viewed from the station platform and from passing trains.

**Warm Springs/South Industrial Visual Analysis Area.** In this visual analysis area, no visual impact mitigation measures are required for the line itself. BART would give special attention to the detailed designs for the South Warm Springs Station to make it compatible with the surrounding environment. Landscaping would have similar goals to those suggested for the Warm Springs Station. Landscaping would be provided within the parking areas to visually break up the expanses of paving, to provide shade, and to provide protected circulation areas for pedestrians. To maximize visual interest, the landscape plan would protect views towards the hills to the east. In addition, through the use of distinctive plantings it would strive to create a sense of place.

The rail car wash facility would, to the extent feasible, make use of the forms, textures, and colors of buildings in the surrounding industrial parks, and use of reflective materials would be

### 3.8 Visual and Aesthetic Quality

avoided. Landscaping would be used to screen views of the facility and emergency maintenance/inspection pit, and to add visual interest.

#### **Residual Impacts After Mitigation**

**Central Fremont and Central Park Visual Analysis Area.** Between Walnut Avenue and Stevenson Boulevard, the elevated structure and part of the bermed portion of the alignment would become important elements in views from units on the north side of the Fremont Villas condominium complex and from units in future high density residential complexes to the east. Although tree planting along the alignment would provide partial screening of the structures as viewed from the residential units, the residual visual impacts would be significant.

The aerial structure's crossing of Stevenson Boulevard would be prominently visible in the field of view of travellers on this City-designated scenic route. However, the presence of the planned swim center and public safety building, and the landscaping proposed for the area around the aerial structure along both sides of the road would reduce the amount of the structure that is visible and would reduce its relative importance in the scene. Although some visual impacts would remain, they would not constitute a significant adverse environmental effect.

In the recreation area on the northside of Central Park, the integration of the aerial structure into the reconfigured site plan, the maturing of existing plantings and the establishment of additional screening landscaping would reduce the aerial structure's visual effects to a level that is acceptable in an area developed for active recreation. As a consequence, in this area, the structure's visual impacts would not constitute a significant adverse environmental effect.

In the now vacant area on the north side of the lake, the proposed landscaping would greatly reduce the project's visibility and contrast with its setting, but it would still have a significant visual impact because of the sensitivity of views into this area from nearby and more distant areas around the lake.

Figure 3.8-5C illustrates what the view across the lake towards the aerial structure could look like with maturing of the existing vegetation and the addition of further plantings as a mitigation measure.

In the park, the aerial structure's greatest and most significant residual impacts would be at the crossing of Lake Elizabeth and in the adjacent riparian forest. The structure's crossing of the lake's eastern arm would be clearly visible from across the lake. However, from that vantage

### 3.8 Visual and Aesthetic Quality

point, the structure would appear to be a relatively small component of the view. The visual impact would be more significant in views from portions of the lake trail close to or immediately adjacent to the structure, where the structure would be visually dominant. From the adjacent lake trail, views into the riparian forest would be transformed by the removal of the natural vegetation to make way for the aerial structure, creating an open corridor in an area where there had been a solid vegetative screen.

Where it crosses Paseo Padre Parkway, the aerial structure would be visible to roadway users as they approach and pass under it, but the screening landscape provided along both sides of the road would reduce the amount of the structure that would be visible and would reduce its dominance, bringing its visual impact down to a level that would not constitute a significant adverse environmental effect.

**Irvington Visual Analysis Area.** The segment of the alignment between Paseo Padre Parkway and Washington Boulevard would have few residual impacts because much of the line in this area would be below grade. The mitigation proposed would eliminate the potential long-term impacts from the removal of existing vegetation during construction.

In the portion of the rail corridor adjacent to Driscoll Road, the proposed landscaping will improve the appearance of the cleared area, and will partially screen views of the cuts for the below-grade tracks, reducing the visual impacts to a level that is less than significant. Although the appearance of the Irvington Station site would be transformed, with the mitigation measures proposed, the effects on the area's visual quality would be positive, with the addition of well designed improvements and landscaping to an area that is now somewhat unkempt in appearance. Between the Irvington Station area and the south end of the Irvington visual analysis area, the visual changes would not be significant.

**North Industrial Visual Analysis Area.** In this area, with mitigation, the BART line and Warm Springs station would not create any negative visual impacts of major significance.

**Warm Springs/South Industrial Visual Analysis Area.** In this area, with mitigation, the BART line, South Warm Springs station, and end-of-line facilities would not create any negative visual impacts of major significance.

### 3.8.4 IMPACTS OF DESIGN OPTIONS

#### Design Option 1

**Direct Impacts.** Only a short segment of an elevated embankment would be visible to occupants of the Fremont Villas condominium complex and the other housing complexes that are likely to be built nearby in the future. The visual impacts in the Albany Commons area would not be significant.

In Central Park, the only structural evidence of the presence of the BART line would be a emergency ventilation tower located south of the softball fields. The primary visual evidence of the line's presence would be in the area of riparian vegetation around the silt pond. Here, the disturbances created during the construction period would be likely to have a short-term visual effect creating a cleared swath through an area that is now a solid mass of vegetation. At the crossing of the Paseo Padre Parkway, the line would be underground and would not be visible.

**Construction Period Impacts.** The construction period impacts for this option would be more extensive and significant than those for the Proposed Project and would last for a longer period of time, due to excavation for the entire length of the underground segment. Visual impacts associated with the construction would include the presence of heavy equipment, disturbance of vegetation in the construction zone, the creation of large piles of excavated material, installation of a coffer dam in the lake, and draining of a portion of the lake. The most severe and significant visual impacts would be in the riparian forest around the siltation pond, where the construction activities would require removal of much of the existing vegetation, creating a cleared swath through an area that is now a solid mass of vegetation. This would affect views from the nearby portions of the path around the lake, and would alter the vegetative backdrop seen in views from across the lake.

**Mitigation Measures.** BART should carry out and complete the cut-and-cover operation in as short a time period as possible, and should immediately restore the ground surface to its original configuration and replace all vegetation that has been removed. Special measures should be taken during the construction process to minimize disturbance of the riparian forest and to make special efforts to restore this area's vegetation to its pre-excavation conditions.

### 3.8 Visual and Aesthetic Quality

To reduce the visibility of the emergency ventilation shaft, BART should use surface treatments and colors that would help it blend into its surroundings. In addition, plantings should be established in the surrounding area to provide screening.

**Residual Impacts After Mitigation.** After mitigation, particularly after restoration of the vegetation in the riparian forest, this option's visual impact will be reduced to a level that is less than significant. The temporary construction period impacts will remain significant even though they will be somewhat tempered by the mitigation measures proposed.

#### Design Option 2A

**Direct Impacts.** In views from the area along Stevenson Boulevard, the effects of Design Option 2A would be generally the same as those of the Proposed Project.

In the undeveloped, open area along the north side of the lake the impact would be considerably less severe than that of the Proposed Project because the aerial structure would be set back approximately 600 feet from the lakeshore, behind the landscaped berm defining the soccer fields. However, the existing screening would not reduce the visibility and contrast of the structure enough in views from the lakeside path and in views from other areas around the lake to reduce its impacts to a less than significant level. Because the aerial structure would cross directly over New Marsh, it would visually dominate views of the pond, creating a significant impact.

Figure 3.8-6A depicts the appearance of the Design Option 2A structure as seen from the end of Sailway Drive on the lake's west side. As the simulation indicates, the aerial structure under this option would appear taller than the aerial structure built under the Proposed Project because of the need for the extra height to cross the railroad tracks immediately behind the lake. North of the lake, the existing berm and plantings provide partial screening that would help to integrate the structure into its backdrop, decreasing its visual prominence in views from this area. The structure would not cross the lake, and would not break up the lake's spatial volume. The structure would disappear behind the existing vegetation immediately after crossing the railroad tracks, and less of the aerial structure would be visible at the eastern end of the lake under this option than under the Proposed Project. However, the portion of the aerial structure passing along the lake's eastern edge will have significant impacts because of its dominance of close-range views from the adjacent lakeside path and its high visibility and contrast in views from other areas around the lake.

### 3.8 Visual and Aesthetic Quality

Design Option 2A would not disturb the riparian forest surrounding the silt pond. Instead, the structure would travel along the eastern side of the STPCo tracks where it would not be visible from the park's most heavily used areas, and where it would not have a significant visual impact. The structure also would not be prominently visible in views from the back yards of homes along Valdez Way. In the areas adjacent to the crossing of Paseo Padre Parkway, this option's impacts would be similar to those of the Proposed Project.

**Cumulative Impacts.** The cumulative impacts would be the same as those described for the Proposed Project.

**Construction Period Impacts.** Design Option 2A's construction period impacts would be generally similar to those of the Proposed Project, although they would be considerably less severe in the area along the east side of the lake.

**Mitigation Measures.** In the area between the Fremont Station and Stevenson Boulevard, BART would apply the same mitigation measures recommended for the Proposed Project. New Marsh would be relocated so that its eastern shoreline lies far enough west of the proposed alignment to provide room for establishment of plantings that would screen the aerial structure from view. At the east end of the lake, the shoreline would be moved westward to provide additional room for planting between the aerial structure and the lake. Berms and tall, thick, fast-growing plantings would be used in the area between the BART alignment and the lakeside path to screen views of the aerial structure from the path. Plantings of riparian species would be established between the lakeside path and the lake to provide additional screening of views from other areas around the lake.

In the area between the two railroad tracks lying east of the silt pond and nature area, the primary mitigation measure would be to restore the ground surface and naturally occurring vegetation. In addition, plantings would be established around the structure to screen the views from the pedestrian pathway that provides access from the residential area to the east, and from any use areas that might be developed within the corridor to the north. In the area east of the nature area and adjacent to Paseo Padre Parkway, the same mitigation measures would be applied as under the Proposed Project.

**Residual Impacts After Mitigation.** In the area between the Fremont Station and Stevenson Boulevard, the residual impacts would be the same as those created by the Proposed Project.



### 3.8 Visual and Aesthetic Quality

In the portion of Central Park in the recreation complex, the aerial structure would be a visible element of the scene. However, its impacts would be lessened by measures to integrate it into the design of the parking areas and recreation complexes and by the maturing of existing vegetation and the addition of new vegetation that would help to screen it in views from nearby and more distant areas. The aerial structure would not substantially interfere with views of the ridgeline and Mission Peak from this area. Because of the opportunities to integrate the aerial structure into its setting in this area, the residual visual impact would be less than significant.

The impacts on the north lakeshore area would be of only moderate significance at the reconfigured New Marsh. Residual impacts would be less than significant. At the easternmost end of the lake, mitigations would reduce the impacts to a level that would be less than significant.

#### **Design Option 2S**

The design characteristics and visual impacts of this design option would essentially be the same as those of Design Option 1. The most significant differences are that the alignment would not cross under Lake Elizabeth and the riparian forest. As a consequence, this alternative would not create the construction period visual impacts associated with Design Option 1 in the lake and riparian forest areas and would not create the temporary cleared swath in the riparian forest that Design Option 1 would produce.

Although this option avoids Design Option 1's most severe construction period visual impacts, the remaining construction period visual impacts would be significant, even after mitigation. As is the case with Design Option 1, the residual direct impacts would not be significant.

#### **Design Option 3**

**Direct Impacts.** Overall, the visual impacts of this option would be less severe than those of the Proposed Project. In views from the area along Stevenson Boulevard, the effects of this option would be generally the same as those of the Proposed Project. In the recreation complex on the north side of Central Park, the alignment and impacts would be very similar to those of Design Option 2A.

The structure would skirt the eastern edge of New Marsh, having a significant effect on its appearance creating a significant visual impact.

### 3.8 Visual and Aesthetic Quality

This option would not cross the path circling the lake and would not cross the lake itself. The point at which it would cross the SPTCo tracks would be approximately 200 feet north of the lakeside path. Because of the height required of the structure at this point, it would visually dominate views from the adjacent path, creating significant impacts.

This option would not cross the area of natural vegetation surrounding the silt pond and would not disturb this area's appearance. It would not be visible from the park's most heavily used areas, and would not have significant impacts on views from the park. Figure 3.8-6B depicts the appearance of the aerial structure as seen from the end of Sailway Drive on Lake Elizabeth's west side. The aerial structure under this option would not appear to be quite as tall as the aerial structure in Design Option 2 because the structure itself and its crossing of the SPTCo tracks would be more distant. North of the lake, the existing berm and plantings would provide partial screening that would help to integrate the structure into its backdrop, decreasing its visual prominence. Less of the aerial structure would be visible at the eastern end of the lake under this option than under the Proposed Project.

As it passes along the west side of the UPRR right-of-way, the aerial structure would cause the removal of a portion of an area of natural vegetation lining the tracks near the border of the park property. The structure would also be highly visible from the backyards of homes on the west sides of Valdez Way, Vaca Drive, and Valero Drive creating significant visual impacts for residents in those areas. This is illustrated in Figure 3.8-7B which simulates a view of this design option from a backyard on Valdez Way.

As it crosses Paseo Padre Parkway, this option's alignment would be located slightly further to the east than the Proposed Project's but its impacts would be generally similar.

#### **Cumulative Impacts**

The cumulative impacts would be the same as those described for the Proposed Project.

**Construction Period Impacts.** Design Option 3's construction period impacts would be generally similar to those of the Proposed Project, although as would be the case with Design Option 2A, they would be considerably less severe in the area along the east side of the lake. Because the construction activities would dominate views from the lake area, they would create significant visual impacts.

### 3.8 Visual and Aesthetic Quality

**Mitigation Measures.** In the area between the Fremont Station and Stevenson Boulevard, BART would apply the same mitigation measures recommended for the Proposed Project. In the recreation complex and the area along the north side of Lake Elizabeth, BART would apply the same mitigation measures as proposed for Design Option 2A.

New Marsh would be reconfigured so that its eastern shoreline lies far enough west of the proposed alignment to provide room for establishment of plantings that would screen the aerial structure from view, reducing its visual dominance from this small-scale feature. Berms would be created, and dense plantings established in the area between the aerial structure and the lake to screen views of the structure as seen from the nearby pathway and from viewing points across the lake.

In the area where the alignment crosses the corridor between the two railroad lines, the ground surface and naturally occurring vegetation would be restored. In addition, plantings would be established around the structure to screen it from views from the lake area, from the pedestrian pathway that provides access from the residential area to the east, and from any use areas that might be developed within the corridor to the north. Tall, dense plantings would be established on the west side of the structure along the both sides of Paseo Padre Parkway to minimize the portions of the aerial structure that could be seen from the road.

**Residual Impacts After Mitigation.** In the area between the Fremont Station and Stevenson Boulevard, the residual impacts would be the same as those created by the Proposed Project. In the recreation complex and the area along the north side of Lake Elizabeth, this design option would have the same impacts as Design Option 2A.

At most locations, mitigations would reduce impacts to less than significant. However, because there appear to be no opportunities to install screening vegetation on the east side of the right-of-way as it passes in proximity to the homes on the east side of the rail corridor, the elevated structure would be highly visible from backyards in this area, and the impacts would be significant.

#### **Other Design Options**

##### **Paseo Padre Parkway Design Option**

This option (crossing of Paseo Padre at-grade) would eliminate the impacts of the aerial crossing of Paseo Padre Parkway and would eliminate the visual clutter associated with the existing

### 3.8 Visual and Aesthetic Quality

at-grade crossings. It would also provide travellers on Paseo Padre Parkway with elevated views of a portion of Central Park. Under this option, the BART line would not directly create significant visual impacts.

#### **Warren Avenue Design Option**

The aerial structure required by this option would be highly visible to travellers on Mission Boulevard and Warren Avenue. Under this option, the tracks would transition onto an aerial structure at a point approximately 800 feet north of Mission Boulevard. This structure would be similar in design to those being used in the Central Fremont and Central Park visual analysis area. At Mission Boulevard, the aerial structure would be 16 feet above the elevation of the railroad bridges. (Here, the depressed surface of the boulevard's roadway lies 15 feet below the bridges.) At Warren Avenue, the structure would be 23.5 feet above the surface of the street. Just to the south of the Warren Avenue crossing, the aerial structure would begin to descend and the roadbed would return to grade approximately 2,000 feet further south. The aerial structure required by this option would be highly visible to travellers on Mission Boulevard and Warren Avenue.

The impacts would be significant at Mission Boulevard, a heavily travelled road that is both a city- and county-designated scenic roadway. Here, the elevated structure would intrude on views from the road toward the hills for eastbound travellers and toward the bay for westbound travellers. The elevated structure's curved silhouette and departure from the plane occupied by the existing rail lines would add to its visual prominence and to the sense that it conflicts with the prevailing landscape pattern. Because there are no feasible measures for mitigating these visual effects, the residual visual impact of this option would be significant.

#### **Washington Boulevard Design Option**

This option, involving an aerial crossing of Washington Boulevard, applies to Alternatives 6, 9 and 10, which have no Irvington Station. The application of this design option would have more visual effects than a subway crossing of Washington Boulevard (as in the Proposed Project); its impacts would be significant. The aerial structure and the raised embankment would be visible for the entire distance between Paseo Padre Parkway and Washington Boulevard, significantly affecting views from the surrounding residential neighborhoods. The impacts would be most significant in the vicinity of Washington Boulevard where the high embankment structure would be added to the at-grade rail crossings and overhead signals that already exist in this area. The embankment would be highly visible in local views and in views from the hillside to the east, and would tend to dominate views from nearby areas. During the

### 3.8 Visual and Aesthetic Quality

construction period, this option would produce more visual impacts for Alternatives 6, 9 and 10 because of the activities required to build the aerial structure and raised embankment.

As mitigation, landscaping would be provided in the rail corridor to screen views of the aerial structure and raised embankment from the surrounding residential neighborhoods. In addition, in the vicinity of Washington Boulevard, great care would be taken in the detailed design of the embankment. Measures would be applied to reduce its apparent height and bulk, and plantings would be established on its sides to relate it to its setting and reduce its apparent massiveness. This option would have a significant residual visual impact brought about by the effects of the raised embankment on views in the area immediately surrounding it.

#### **UPRR Relocation Design Option**

The advantage of the UPRR relocation option is that it would make it unnecessary to encroach on the industrial park properties lying to the east side of the rail corridor. As a consequence, no existing buildings would need to be removed, and the existing landscaping along the edges of the industrial park properties would remain intact. This option's direct, cumulative, construction, and residual impacts would be generally similar to those associated with the Proposed Project but would be lighter because none of the features on adjacent properties would be disturbed.

#### **3.8.5 IMPACTS OF ALTERNATIVES 1, 2 AND 3**

Alternatives 1, 2 and 3 would not directly create any major physical changes to the study area, and therefore these alternatives would have no direct impacts on the area's visual and aesthetic quality.

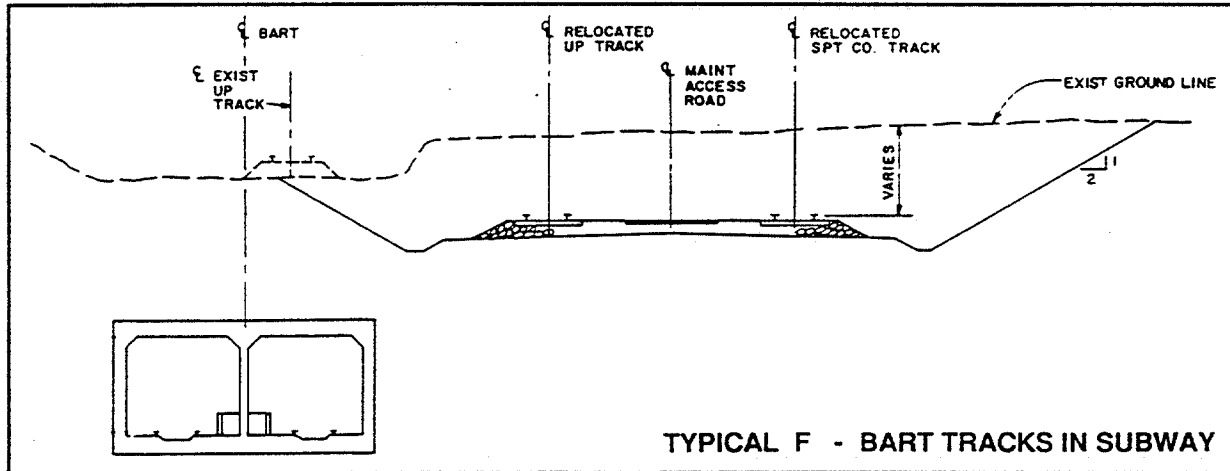
#### **3.8.6 IMPACTS OF ALTERNATIVE 4: A 5.4-Mile BART Extension with Two Stations, and Relocated Railroad**

##### **Direct Impacts**

In the Central Fremont/Central Park visual analysis area, Alternative 4 would have the same design and direct impacts as either the Proposed Project or Design Options 1, 2A, 2S or 3 in the area from the Fremont Station to the portion of the rail corridor east of Central Park's Nature Area.

### 3.8 Visual and Aesthetic Quality

The BART tracks would cross under the SPTCo and UPRR tracks at a point about 700 feet south of Paseo Padre Parkway (Typical F). After being crossed by BART, the two rail lines would slope downwards, and all three sets of tracks (BART, SPTCo and UPRR) would travel alongside each other in an open trench (Typical G). The open trench would continue south to Washington Boulevard where the BART line and tracks would enter tunnels.

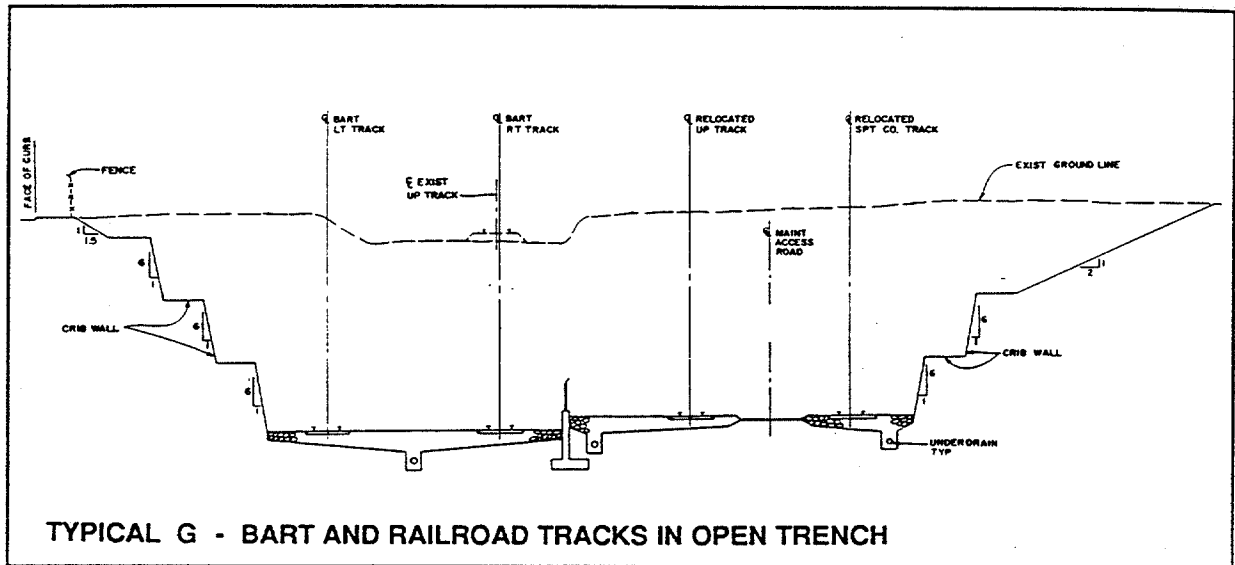


The impacts of this alternative would not be significant here because the BART tracks and relocated rail tracks would all be at or below grade, and because existing fences and noise walls would provide good screening. At the south end of this area, the changes would be significant and highly visible. For viewers on Driscoll Road near Washington Boulevard, and residents of some of the nearby homes on Driscoll Road, the existing view would be transformed. What is now a view of an at-grade rail corridor with a mixture of commercial uses housed in older structures would become a view of an area that is entirely open and occupied by a trench over 200 feet wide and 40 feet deep.

Near the proposed Irvington Station, the alignment of this alternative differs somewhat from the Proposed Project, but the aesthetic impacts would be substantially the same and would not be significant.

Between Durham Road and the proposed Warm Springs Station, this alternative would have no visual impacts of any significance because of its mostly at-grade location. Because its elevated section would be only approximately 10 feet above the existing ground surface, its visibility would be limited, and it would create even fewer visual concerns than the Proposed Project.

### 3.8 Visual and Aesthetic Quality



The Warm Springs Station would be the line's terminus, but the station's design would be essentially the same as in the Proposed Project and would have similar impacts. South of the station, the aerial structure would slope downwards and the tailtracks would transition to an at-grade roadbed and would continue for another 2,500 feet before terminating. A car wash structure approximately 200-feet long, 25-feet high, and 25-feet wide would be built over the western tracks in the tailtrack area. Because they would be hidden by the NUMMI facilities to the west and the industrial buildings along Warm Springs Court to the east, the tailtracks, car wash building and emergency maintenance/inspection pit would not create significant visual impacts.

#### Cumulative Impacts

The cumulative impacts would be the same as those described for the Proposed Project.

#### Construction Period Impacts

In most locations, the construction period impacts would be essentially the same as those under the Proposed Project.

Between Paseo Padre Parkway and Washington Boulevard, excavation would necessitate more heavy equipment to remain on the scene over a longer period of time than would be the case with the Proposed Project. In addition, under this alternative, there is the possibility that there

### 3.8 Visual and Aesthetic Quality

would be more on-site storage of spoils. Near the Warm Springs Station, the construction period impacts would be generally the same as those under the Proposed Project, although their extent would be somewhat reduced by the fact that there would be less aerial construction.

#### **Mitigation Measures**

In general, the same mitigation measures recommended for the Proposed Project would be applied to this alternative. The only change to these suggestions would be along the rail corridor just north of Washington Boulevard. Here, screening fences would be built along Driscoll Road, along the backs of the adjacent Driscoll Road properties, and along the west side of the rail corridor to block views across the wide, deep depression that would be created. In addition, street trees with tall, thick canopies should be planted in front of the screening fence along Driscoll Road to screen views into the rail corridor from elevated viewpoints to the east.

#### **Residual Impacts**

After mitigation, Alternative 4 would have much the same visual impacts as the Proposed Project.

#### **3.8.7 IMPACTS OF ALTERNATIVE 5: A 5.4-Mile BART Extension with Two Stations**

From the Fremont Station to the proposed Warm Springs Station, the direct visual impacts, cumulative impacts, construction impacts, recommended mitigation measures, and residual visual impacts would be the same as they would be for the Proposed Project and related options. From the proposed Warm Springs Station to the end of the tailtrack approximately 3,000 feet to the south, the direct visual impacts, construction impacts, recommended mitigation measures, and residual visual impacts would be the same as they would be for Alternative 4.

#### **3.8.8 IMPACTS OF ALTERNATIVE 6: A 7.8-Mile BART Extension with Two Stations (no Irvington Station)**

For most of its length, Alternative 6 would have the same appearance, direct visual impacts, cumulative impacts, construction impacts, recommended mitigation measures, and residual visual impacts as the Proposed Project. Alternative 6 does not include an Irvington Station, so there would be no visual effects related to station construction. The Washington Boulevard Design

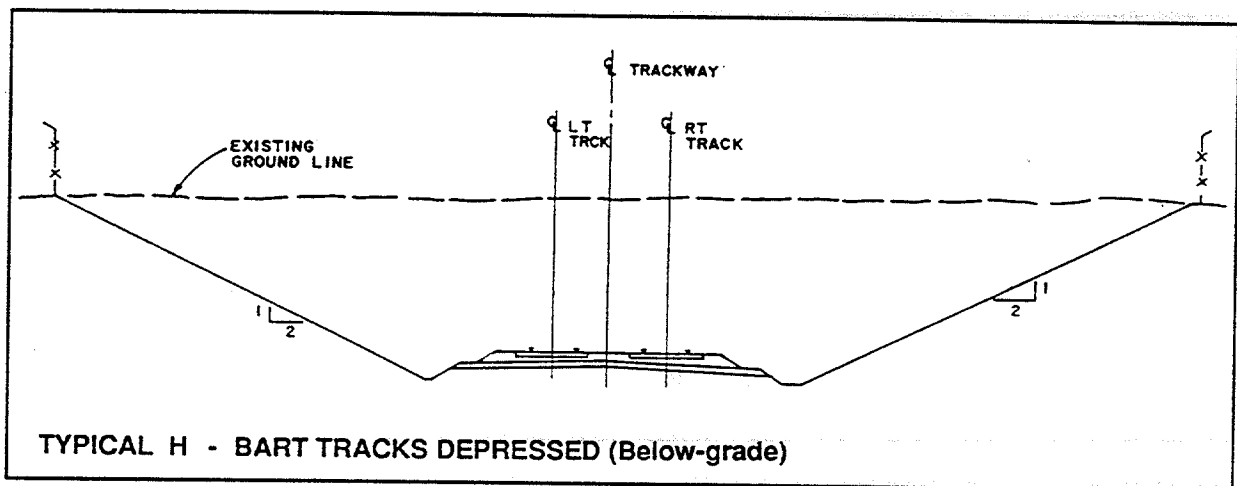


### 3.8 Visual and Aesthetic Quality

Option would apply to Alternative 6, as would all of the Central Park design options and the Paseo Padre Parkway Design Option. The alternative also varies from the Proposed Project in the treatment of the UPRR and SPTCo tracks.

#### Direct Impacts

Under this alternative, the proposal for the Paseo Padre Parkway through the Washington Boulevard stretch of the line is for the tracks to continue on an aerial structure for the first 1,600 feet south of Paseo Padre Parkway and then transition to grade and into a below-grade cut through which they would travel under Washington Boulevard. This cut, which would contain the BART tracks only, would be approximately 135-feet wide and would be 20-feet deep at its deepest point near Washington Boulevard (Typical H). Approximately 2,500 feet south of Washington Boulevard, the tracks would transition back to an at-grade roadbed that would be the same as under the Proposed Project.



This alternative's visual impacts would differ from those of the Proposed Project in that the existing rail lines would remain at grade and that the cut for the BART tracks would be open to view on both sides of Washington Boulevard. To construct this alternative, as is the case with the Proposed Project, the commercial structures and building material storage yards that now exist in the rail corridor would be removed. Unlike the Proposed Project, the area south of Washington Boulevard would remain open and would not be developed with a concourse structure, circulation and parking areas, and landscaping. The result of this alternative would be to create a visually open swath along both sides of Washington Boulevard that would be visible from the boulevard and from Driscoll and Osgood Roads. This alternative would not

### 3.8 Visual and Aesthetic Quality

have the advantage of removing the existing at-grade railroad tracks and overhead signals from the Washington Boulevard corridor. The overall visual impact would be significant.

With the application of Central Park Design Option 1 or 2S, Alternative 6 could have a subway tunnel which would begin in Central Park and continue through much of the corridor south of Paseo Padre Parkway, opening into an uncovered cut about 1,000 feet north of Washington Boulevard. The BART tracks would pass under Washington Boulevard and the depressed roadbed would slope up and return to grade approximately 2,500 feet to the south. This variant would create virtually no visual impacts for the adjacent residential areas. In the area closest to Washington Boulevard, its impacts would be generally similar to those described above for this alternative's primary option.

#### **Construction Period Impacts**

During the construction period, the visual impacts of this alternative and subway variant would be generally similar to the impacts created by the Proposed Project.

#### **Mitigation Measures**

For this alternative, fences and landscaping would be provided along both sides of the alignment in the vicinity of Washington Boulevard to screen views from Driscoll and Osgood Roads and from the neighborhoods to the west.

#### **Residual Impacts After Mitigation**

For Alternative 6, the impacts would be generally similar to those of the Proposed Project, with the exceptions that there would be no changes brought about by development of an Irvington Station, that at-grade rail crossings and overhead rail signals would still exist at Washington Boulevard, and that travellers along Washington Boulevard would have views of an open right-of-way to the south.

#### **3.8.9 IMPACTS OF ALTERNATIVE 7: A 7.8 Mile BART Extension with Two Stations (no Irvington Station)**

From the Fremont Station to Paseo Padre Parkway, this alternative's appearance, direct visual impacts, construction impacts, recommended mitigation measures, and residual visual impacts

### 3.8 Visual and Aesthetic Quality

would be the same as those described for the Proposed Project and its Central Park design options. Between Paseo Padre Parkway and Washington Boulevard, this alternative's design and its visual effects would be generally similar to those described in the Washington Boulevard Design Option. From the Warm Springs Station to the end of the line at the border with Santa Clara County, this alternative's visual effects also would be the same as those described for the Proposed Project. This alternative's visual effects for the segment between Washington Boulevard and the Warm Springs Station would differ from those of the Proposed Project in the ways described and evaluated below.

#### **Direct Impacts**

In the area immediately to the south of Washington Boulevard, this alternative's visual effects would be somewhat similar to those created by the Washington Boulevard Design Option (an above-grade crossing on an embankment). In Alternative 7, use of the aerial structure would make the views of the area south of Washington Boulevard more open than they would be under the Washington Boulevard Design Option, since the aerial structure would be somewhat less visually dominant than an elevated embankment. However, because the structure would have to be over 30-feet high in the area between Washington Boulevard and the UPRR crossing, it would be highly visible from the residential neighborhood to the west and from Osgood Road, creating a significant visual impact. Figure 3.8-7D is a simulation of this alternative's crossing of Washington Boulevard as seen from viewpoint 4 on Figure 3.8-2.

South of the UPRR tracks, the aerial structure decreases to the range of 20 to 25 feet. In the area between its crossing of the UPRR tracks and South Durham Boulevard, the BART elevated structure would generally be visible from the backyards of the homes located on the west side of the rail corridor, but would be located at least 140 feet from the back property lines and would not be as visually dominant. Figure 3.8-8C depicts the elevated structure's appearance as viewed from the playground of the Grimmer School. In this area, the impacts would be less than significant.

The aerial structure would be visible in the area to the east of the rail corridor, but would not bring about a significant change in the area's overall visual character, and would not create significant visual impacts. Between Durham Road and the proposed Warm Springs Station, this alternative would not have significant visual impacts given the relatively low height of most of the elevated segments and the industrial character of the setting.

## 3.8 Visual and Aesthetic Quality

### **Cumulative Impacts**

The cumulative impacts would be the same as those described for the Proposed Project.

### **Construction Period Impacts**

The most significant construction period impacts would take place in the area around Washington Boulevard, where the heavy equipment and aerial construction activities would be most visible from Washington Boulevard, Osgood Road, and surrounding residential areas.

### **Mitigation Measures**

The primary mitigation measure for the Washington Boulevard to Warm Springs Station segment of Alternative 7 would be to establish heavy plantings of vegetation around both sides of the aerial structure in the vicinity of Washington Boulevard to screen views of it from nearby and more distant streets and residential areas. In the area to the immediate south of the Washington Boulevard vicinity, there does not appear to be enough space between the aerial structure and the UPRR tracks to establish plantings that would play a meaningful role in screening views from the residential area to the west.

### **Residual Impacts After Mitigation**

The residual visual impact of the Washington Boulevard to Warm Springs Station segment of Alternative 7 on views from streets and residences in the immediate vicinity of Washington Boulevard and Osgood Road would be significant because the structure's height would make it a dominant element in many views. The impacts on the quality of views from the Grimmer School and from the backyards of homes lying immediately to the west of the rail corridor would not be significant.

### **3.8.10 IMPACTS OF ALTERNATIVE 8: A 7.8-Mile Extension along Osgood Road and Warm Springs Boulevard, with Two Stations (no Irvington Station)**

From the Fremont Station to Paseo Padre Parkway, this alternative's appearance, direct visual impacts, construction impacts, recommended mitigation measures, and residual visual impacts would be the same as those described for the Proposed Project. This alternative's visual effects for the segment between Washington Boulevard and the end of the extension at the Santa Clara

### 3.8 Visual and Aesthetic Quality

County line would differ from those of the Proposed Project in the ways described and evaluated below.

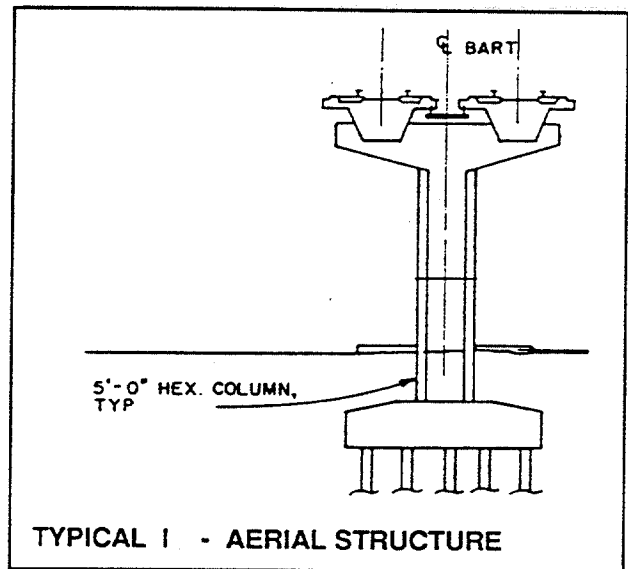
#### Direct Impacts

Between Paseo Padre Parkway and Washington Boulevard, this alternative would be generally similar to the Washington Boulevard Design Option, with an elevated embankment spanning the last 1,000 to 1,600 feet before Washington Boulevard. It would differ in that the alignment would curve slightly to the west within the rail corridor at a point about 1,000 feet north of Washington Boulevard and then curve to the east side of the corridor as it approaches the boulevard.

The elevated tracks would cross Washington Boulevard at a track height of about 24 feet. Shortly south of the boulevard, the BART tracks would cross over the UPRR tracks and transition onto an aerial structure that would cross the southbound lane of Osgood Road and take up an alignment that runs down the middle of the street. The design of the aerial structure that would be used in this area is depicted in Typical I.

In the area between Paseo Padre and Washington Boulevard, the aerial structure, which would be over 35 feet high in places, would be visible from the surrounding residential neighborhoods. The elevated embankment section would be particularly visible as it passes alongside the western edge of the rail corridor just north of Washington Boulevard and as it makes its angled boulevard crossing. The high, bulky embankment would be visually dominant in nearby views, especially from Washington Boulevard and Driscoll Road, creating a significant visual impact.

South of Washington Boulevard, the elevated facility would be highly visible to travellers on Osgood Road, and the aerial structure's crossing of the southbound lane would impinge on the view down the road. In the rest of this visual analysis area where aerial structure would travel down the middle of the street, the structure would be highly visible, and would completely



### 3.8 Visual and Aesthetic Quality

dominate the streetscape. Figure 3.8-9B simulates a view of what the aerial structure would look like from further to the south on Warm Springs Boulevard. The visual impacts of the aerial structure in this area would be somewhat moderated by the fact that the area is zoned for industrial use and that the structure would not be out of scale or character with the large utilitarian buildings which now exist, and are likely to be developed along the street in the future. However, the overall impact would be significant.

The most problematic visual issues along the Osgood Road corridor may be in the area just north of Durham Road where the aerial structure would cross under two electric transmission corridors containing a total of seven different transmission lines. To maintain the clearances required by the California Public Utilities Commission, the heights of these lines may have to be increased where they cross over the elevated BART line. Raising the height of the lines would involve replacing the towers on each side of the BART line with new, taller structures. Because they would be taller, the new towers would be visible over a wider area and would be more visually prominent than those that are there now. If the new towers were to be different in design from those now used on the same transmission lines, they would call even more attention to themselves. The visual impacts would be significant.

As the elevated structure crosses Durham Road, it would be highly visible to travellers on this thoroughfare, and would visually dominate the busy intersection with Osgood Road, creating significant impacts.

As the alignment passes through the north industrial visual analysis area, it would continue to be on an aerial structure that, for the most part, would travel down the centers of Osgood Road and Warm Springs Boulevard.

In most of this area, the visual impacts would be similar to those described in the discussion of the Osgood Road area in the text above. One area where they would be slightly different would be at the Warm Springs Station where the aerial structure would cross over to the west side of the road to pass along the eastern edge of the station site. Because the structure would cross over to the road's west side just before South Grimmer Boulevard, the structure would not cross through the center of the Warm Springs Boulevard or the South Grimmer Boulevard intersection, somewhat reducing the visual impacts of crossing this heavily-travelled road. Although the station would generally have the same appearance and impacts as those described for the Warm Springs Station in the analysis of the Proposed Project, the location of the aerial structure, concourse and platform at the site's eastern edge would make all of these facilities prominently visible from the nearby segment of Warm Springs Boulevard.

### 3.8 Visual and Aesthetic Quality

To avoid a jog in the road near Corporate Way, the aerial structure's alignment would leave the center of the roadway for a time, but would create a cleared swath that would be highly visible from the boulevard.

As the aerial structure crosses Mission Boulevard, it would pass through the center of the Mission Boulevard/Warm Springs Boulevard intersection, adding a major new element to a scene that already has a high degree of visual complexity. The visual changes produced here would be important because Mission Boulevard carries very high volumes of traffic and because this area is a focal point for the Warm Springs District. Here, the impacts would be very significant.

From Mission Boulevard to the vicinity of Whitney Place, the aerial structure would continue to travel down the center of Warm Springs Boulevard. Figure 3.8-9B depicts the structure as it would appear when viewed looking south from the west side of Warm Springs Boulevard at Mission Falls Lane. As this simulation suggests, the structure would alter the street's present median treatment and would become a visually dominant element of the streetscape. Although it would not be visually incompatible with the large industrial and office structures on the west side of the road, its scale and character would contrast with those of the residential areas that back up to the road's eastern edge. Most of the homes lining the boulevard's east side would have views of the structure. Although the changes to these backyard views would be noticeable, the structure would have only minor effects on views from other areas in these neighborhoods. Overall, the structure's visual effects on this section of the boulevard would be significant.

Near Whitney Place, the elevated structure would cross over the boulevard's southbound lane and curve onto the properties on the east side of the road that are now occupied by large light industrial buildings. The area now occupied by these buildings and the large vacant parcel to their rear would be developed as the site of the South Warm Springs Station. From the elevated station platform, the tailtracks would slope down towards Kato Road, and after crossing Kato Road, would be at grade and would parallel the rail corridor.

At the point where it would cross Warm Springs Boulevard, the aerial structure would partially block the vista down the roadway. The removal of the buildings along Warm Springs Boulevard near Whitney Place would transform this area's appearance, creating a view that would be more open and that would be dominated by landscaped parking areas. In very general terms, the proposed station's appearance and impacts would be similar to those described for the South Warm Springs Station under the Proposed Project. The car wash structure and emergency maintenance/inspection pit proposed for the tailtrack area would not be of significant visual

### 3.8 Visual and Aesthetic Quality

concern because it would be screened by the adjacent industrial buildings, and would be similar to them in form and character.

#### **Construction Period Impacts**

During the construction period, the major visual changes would be associated with the presence of heavy construction equipment along the alignment and disruption of the street surface and the presence of overhead construction activities along Osgood Road and Warm Springs Boulevard. These visual impacts would constitute temporary but significant visual impacts.

#### **Mitigation Measures**

In the area around the intersection of Washington Boulevard and Driscoll Road, the elevated embankment's impacts would be mitigated through careful design of the embankment's details, appropriate landscaping of the embankment's sides, and planting of buffer screening. Buffer screening would also be provided around the elevated structure in the area just before it crosses onto Osgood Road.

Where the aerial structure travels down the centerlines of Osgood Road and Warm Springs Boulevard, the median strip under the structure would be provided with permanent, irrigated landscaping that would complement the landscaping on the roadway's edges.

To compensate for the aerial structure's visual intrusion into the streetscape along Osgood Road and Warm Springs Boulevard, BART would underground the overhead utilities that now run along these streets.

If the transmission lines north of Durham Road require a significant increase in height to maintain proper clearance under the conductors, BART would consider undergrounding the portions of each of these lines that cross the alignment.

At the crossing of Mission Boulevard, special care would be taken in the design, detailing, and landscape treatment of the aerial structure to reduce its visual prominence and to make it a positive element of this visually important area.



**Residual Impacts After Mitigation**

Even with the application of mitigation measures, the aerial structure would be highly visible and visually dominant as it travels down the centerlines of Osgood Road and Warm Springs Boulevard, creating a significant visual impact. The visual changes would be most highly significant at the crossings of Durham Road, South Grimmer Boulevard, and Mission Boulevard.

**3.8.11 IMPACTS OF ALTERNATIVE 9: A 5.4-Mile BART Extension with One Station (Warm Springs)**

From the Fremont Station to Paseo Padre Parkway, this alternative's appearance, direct visual impacts, cumulative impacts, construction impacts, recommended mitigation measures, and residual visual impacts would be generally the same as those described for that segment of the Proposed Project and the Central Park design options. From Paseo Padre Parkway to the Warm Springs Station, they would be the same as those described for that segment of Alternative 6. From the Warm Springs Station to the end of the tailtracks, they would be the same as those described for the same segment of Alternative 4.

**3.8.12 IMPACTS OF ALTERNATIVE 10: A 7.8-Mile BART Extension with One Station (South Warm Springs)**

For most of its length, Alternative 10 is similar to the Proposed Project, with the same impacts and mitigations. With no Irvington or Warm Springs Stations, however, the visual effects associated with these facilities are eliminated. In addition, in the Irvington Visual Analysis Area there would be some variation in the treatment of the BART tracks between Paseo Padre Parkway and a point approximately 2,500 feet south of Washington Boulevard. The appearance, direct visual impacts, construction impacts, recommended mitigation measures, and residual visual impacts of the possible configurations of the BART line in this area under this alternative would be the same as those described in the analysis of Alternative 6.

## 3.8 Visual and Aesthetic Quality

### **3.8.13 IMPACTS OF ALTERNATIVE 11: A 7.8-Mile BART Extension with Two Stations (no Warm Springs Station)**

For virtually all of its length, Alternative 11 would be the same as the Proposed Project, with the same impacts and mitigations. The only difference from the Proposed Project is that there would be no Warm Springs Station, eliminating the visual effects associated with that facility.

## 3.9 CULTURAL RESOURCES

### 3.9.1 SETTING AND EXISTING CONDITIONS

**Prehistoric Setting.** Research suggests that the greater South Bay area cultural prehistory may have originated as early as 4000 B.C. It appears that continued prehistoric settlement took place in the area, with diffusion of new cultural behaviors and probably entire new populations migrating into the region. Also, studies indicate that most of the South Bay archaeological deposits consist of habitation sites which were usually occupied on a seasonal or semi-permanent basis for several hundred years before abandonment. The presence of favorable environmental circumstances in the South Bay, with extensive freshwater sources, marshlands with aquatic resources and terrestrial plant communities, attracted prehistoric populations to the area from very early times.

Early archaeological work was influenced by the identification in the 1930s of a culture sequence in the lower Sacramento Valley that revealed significant change of culture had taken place in prehistoric central California.<sup>1</sup> The prehistory of the Sacramento Valley was divided into a three-period sequence, consisting of Early (2500 B.C.-2000 B.C.), Middle (2000 B.C.-A.D.500) and Late Horizons (A.D. 500-A.D. 1800). This chronological system came to be known as the Central California Taxonomic System (CCTS).

This system was applied to the San Francisco Bay Area.<sup>2</sup> Alternative approaches were subsequently offered.<sup>3,4</sup> This was largely due to findings that the Bay Area environment was sufficiently different from the Sacramento Valley in subsistence resources, suggesting different cultural adaptations. On the other hand, similarities in material culture imply cultural interaction. It has been concluded that there is strong evidence from change in both the Valley and Bay areas and separate traditions in each, interwoven with evidence of interplay between them -- a complex picture which cannot be portrayed in simply models of parallel or convergent change. It is suggested that archaeologists should draw upon what is useful from both models

---

<sup>1</sup> J. B. Lillard, Robert F. Heizer and Franklin Fenenga, 1939, "An Introduction to the Archaeology of Central California," Sacramento Junior College, Department of Anthropology Bulletin, 2, Sacramento.

<sup>2</sup> Richard K. Beardsley, 1948, "Cultural Sequences in Central California Archaeology," *American Antiquity*, 14(1) p. 1-28. Richard K. Beardsley, 1954, "Temporal and Areal Relationships in Central California," University of California Archaeological Survey Reports 24 and 25, Berkeley.

<sup>3</sup> Bert A. Gerow and Roland W. Force, 1968, *An Analysis of the University Village Complex, with a Reappraisal of Central California Archaeology*, Stanford University, Palo Alto.

<sup>4</sup> David Fredrickson, 1974, "Cultural Diversity in Early Central California: A View from the North Coast Ranges," *Journal of California Anthropology* 1(1), p. 41-53.

### 3.9 Cultural Resources

and focus on defining a sequence and tradition or traditions for the Bay Area; to do so, however, will depend upon new data in addition to a re-examination of existing information.<sup>1</sup>

The focal point of archaeological inquiry into the prehistory of the southeastern edge of San Francisco Bay has been a cluster of sites in the Newark area. Three sites, CA-Ala-328 (Patterson Site), CA-Ala-13 and CA-Ala-12, that are now protected within the Coyote Hills Regional Park, were intensively excavated over several decades by various archaeologists.<sup>2</sup>

Analysis of radio-carbon dates and artifacts led archaeologists to conclude that CA-Ala-12 and CA-Ala-328 were first occupied more than 2300 years ago, likely between 3000 and 4000 years ago; CA-Ala-13 was settled much later, circa A.D. 300 and was apparently occupied intermittently for at least a millennium thereafter.<sup>3</sup> CA-Ala-328 realized a period of abandonment between circa A.D. 300 and 1500, but was reoccupied during the last few centuries of the prehistoric era.<sup>4</sup>

Archaeological investigations led to a clear delineation of changes in artifact types and mortuary practices at the three Coyote Hills sites. Parallel changes from schist to sandstone chert and from obsidian of trans-Sierran-origin to North Coast Range obsidian, suggested changes in trade relations over time. Fundamental economic practices appear to have changed very little; also there is no indication of social and cultural replacement at any time, even though individual sites were abandoned for periods of time. These Fremont area sites appear to have been continually occupied by Costanoan peoples over a span of more than 2000 years.<sup>5</sup>

To the east of the Coyote Hills sites (in the vicinity of the Fremont BART station) is CA-Ala-343 which is an extensive prehistoric midden (a midden is a raised mound holding the remnants of a prehistoric dwelling). Excavations in the 1960s and 1980s have led to the conclusion that CA-Ala-343 is a significant prehistoric cultural resource. Archaeological investigations of properties adjacent to the reported location of CA-Ala-343 resulted in no further information regarding

---

<sup>1</sup> Polly Bickel, 1976, "Toward a Prehistory of the San Francisco Bay Area; the Archaeology of Sites Ala-328, Ala-13 and Ala-12," unpublished Ph.D. diss., Harvard University.

<sup>2</sup> Michael J. Moratto, 1984, *California Archaeology*, Academic Press, Inc. p. 253.

<sup>3</sup> Polly Bickel, 1981, "San Francisco Bay Archaeology: Sites Ala-328 and Ala-12," *Contributions of the University of California Archaeological Research Facility* 43 (June), pp. 337-338.

<sup>4</sup> Moratto, 1984, p. 255.

<sup>5</sup> Moratto, 1984, p. 258.

the boundaries, nature or significance of the site.<sup>1</sup> In 1985, archaeologists from San Jose State University conducted additional testing of the site locale and concluded:

Based on this investigation, CA-Ala-343 appears to be the locus of activities associated with permanent occupation sites. This is evidenced by the utilization of an extensive catchment area, evidence of year-round occupation, the presence of a wide variety of grinding, hunting, and manufacturing artifacts and debris, a reported high density of human burials, and the presence of cooking features.

Although at this time information concerning temporal affiliation is lacking, and exact trade relationships are unclear...,it is clear that Ala-343 contains important resources both in its potential to illuminate archaeological research issues and in its value as an educating force for Urban Native Americans...<sup>2</sup>

Data recovered from South Bay resources are an integral part of the archaeological record for the greater Bay Area and contribute significantly to our understanding of the past. As archaeologists continue to make a concerted effort to synthesize their data, the understanding of prehistoric cultural dynamics will be greatly enhanced. Additionally, archaeologists have established methods for determining the significance of archaeological resources, as well as management recommendations for mitigating adverse impacts.<sup>3</sup>

**Historical Setting.** The study area region was explored by the Spanish beginning in 1769 with the expedition of Jose Francisco Ortega. In 1770 and 1772, Pedro Fages led parties through the Santa Clara Valley, and in 1776, Juan Bautista de Anza and Pedro Font explored a larger area. The Mission Santa Clara and California's first civil settlement, the Pueblo San Jose del

---

<sup>1</sup> Robert Cartier, 1981, (secondary), "Subsurface Archaeological Evaluation of the Fremont Office Complex on Walnut Drive and Civic Center Drive in the City of Fremont, County of Alameda," report on file at the California Archaeological Inventory Northwest Information Center at Sonoma State University, Rohnert Park.

Robert Cartier, 1985, "Cultural Resources Evaluation of the Lake Elizabeth Park Expansion Project in the City of Fremont, County of Alameda," report on file at the California Archaeological Inventory Northwest Information Center at Sonoma State University, Rohnert Park.

<sup>2</sup> Jeffrey T. Hall, 1985, "Results of an Archaeological Subsurface Testing Project at CA-Ala-343," report on file at the California Archaeological Inventory Northwest Information Center at Sonoma State University, Rohnert Park, p. 29.

<sup>3</sup> Thomas F. King and Patricia P. Hickman, 1973, "Archaeological Impact Evaluation: San Felipe Division Central Valley Project, Part I, the Southern Santa Clara Valley, California: A General Plan for Archaeology," U.S. Department of Interior, National Park Service, Report on File at the California Archaeological Inventory Northwest Information Center at Sonoma State University, Rohnert Park.

### 3.9 Cultural Resources

Guadalupe, were both established the following year. To the northeast on the *contra costa* or East Bay, the Mission San Jose was established in 1797.

During the Mexican Colonial Period, 1822 to 1848, these settlements were surrounded by large land grants or ranchos. San Jose Pueblo prospered as a regional trade center and its population more than doubled. The Gold Rush swelled the area population, as did the promise that San Jose would become the state capital. However, with the transfer of the state capital to Sacramento and the post-Gold Rush recession, San Jose's expansion slackened.

In 1848, after the signing of the Treaty of Guadalupe-Hidalgo, California became part of the United States, and because of the long-established mission in southern Alameda County as well as the fertile farm and grazing lands, Americans soon began settling in the area. By 1853 Washington Township was established, which consisted of the eight communities surrounding Mission San Jose: Washington Corners (Irvington), Warm Springs, Decoto, Newark, Alvarado, Union City, Vallejo Mills (Niles) and Centerville.<sup>1</sup>

When John M. Horner and his wife settled in Washington Corners (Irvington) in 1847, they became the first Americans to live between Mission San Jose and the border of the *contra costa*. The Horner land, transected by Mission Creek, lay in the vicinity of present-day Driscoll Road and Mission Boulevard. During his first two years of farming, Horner lost his crops to insects and roving cattle, however, by fencing off his planted fields and taking advantage of the Gold Rush inflation, by 1850 he was on his way to making a fortune, selling produce.

John sent for his brother, William Yates Horner, and in 1850 they formed a partnership. Within a few years John M. Horner and Company became the first million dollar enterprise in Washington Township. In 1854 the Horners purchased the first combined harvester and reaper in California, thus introducing improved farming methods and power-driven machinery to the state.

In 1851, the Horners established the first steamboat ferry on the Bay in order to take their vegetables from Alvarado wharf to the San Francisco embarcadero. Passengers who wished to travel further south, from the Alvarado wharf to Mission San Jose, could do so on the Horner stage, the first in the South Bay. Three years later, in order to process their wheat, the brothers built the first steam-driven flour mill in Alameda County.

---

<sup>1</sup> Mission Peak Heritage Foundation, 1989, "City of Fremont, the First Thirty Years, History of Growth," San Francisco: Interprint, p. 7.

### 3.9 Cultural Resources

As civic-minded members of the community, the Horners established the first English-speaking schools in Washington Township, first in Centerville (1850) and later in Washington Corners (1862). Although the Horners paid the salary of the only teacher, these schools were public, open to the community's children. In 1872, William Horner also helped organize Washington College of Science and Industry which was located on Driscoll Road; this was the first institution of higher learning in southern Alameda County.

The Horner family lost almost everything during the post-Gold Rush recession; although he later recovered much of his wealth, in 1879 John M. Horner abandoned California for Hawaii. William Horner apparently remained in Washington Corners, at least temporarily, because records of the time show that he owned 105 acres in that year. Presumably these 105 acres were a part of the 118-acre Driscoll Road property attributed to W.Y. Horner on the Official 1878 Atlas Map of Alameda County.<sup>1</sup>

Washington Corners also witnessed improvements in transportation after the mid-1850s. In 1869, the San Jose branch of the Western Pacific Railroad (later the Southern Pacific Railroad) was completed, which paralleled the old north/south San Jose Road, from Washington Corners south through Warm Springs. The name Irvington was given to the Southern Pacific station in Washington Corners and the name Warm Springs to the station in the settlement of Harrison. As a result, both town officials adopted new names for their communities. The Union Pacific Railroad also laid tracks through Washington Township, just east of the Southern Pacific line.

Warm Springs lay south of Irvington, on land which at one time was part of Rancho del Agua Caliente. The rancho was so named because it contained hot springs which had been used by local Native Americans for hundreds of years. Granted to Antonio Sunol in 1836, three years later the rancho became the property of Fulgencio Higuera.<sup>2</sup> Today, the Galindo-Higuera adobe, circa 1840, stands on the former rancho land well over a mile east of the project area--protected and surrounded by a 19-acre Fremont city park.

---

<sup>1</sup> Thompson and West, 1878, *Historical Atlas of Alameda County*, (Bicentennial Reprint), p. 45.

<sup>2</sup> M. W. Wood, *History of Alameda County, California* (Oakland: M. W. Wood Publisher, 1883), 831-832. Sandoval, 175-178. Mildred B. Hoover, Hero E. Rensch, Ethel G. Rensch and William N. Abeloe, *Historic Spots in California* (Stanford: Stanford University Press, 1990), 11.

### 3.9 Cultural Resources

From the coming of the railroad until well into the twentieth century, southern Alameda County remained a productive agricultural region. Because of the hospitable climate and well-watered soil, Washington Township produced an abundance of market fruits and vegetables.<sup>1</sup>

In 1950, Irvington's population stood at 2,500 while the village of Warm Springs contained only 500 people. Incorporated in 1956 from five existing towns (Irvington, Warm Springs, Centerville, Niles and Mission San Jose), the newly established City of Fremont embraced a population of 43,790 by 1960. Over the last three decades the city has developed into a residential, agricultural and commercial area of wineries and nurseries, automobile and truck manufacturing plants as well as a region into which the Silicon Valley electronics industries are presently extending.

In following the historical route of both roads and rail lines in southern Alameda County, the Proposed Project corridor encompasses a historical transportation routing, and will pass through the previously discussed nineteenth-century settlements. Considerations of historical properties are discussed in relation to those settlement locations.

**Irvington.** The proposed Irvington BART Station is sited in the vicinity of an historic settlement which has been called by various names: the Corners, Washington Corners, Irving, and most recently, Irvington. In 1956, Irvington was incorporated into the new City of Fremont. The "Corners" part of the early name presumably arose from the fact that several roads met at the center of the settlement. In the 1878 Alameda County Atlas, the intersection is shown much as it exists today. Union Street and Bay Street retain their original names. Fremont Boulevard was formerly Centerville/San Jose Road; Washington Boulevard was formerly Mission Road. The Southern Pacific Railroad line ran a block away.

On the northwest corner of Washington Boulevard and Roberts Street is a turn-of-the-century building called the Hotel Irvington, which also houses a general store. To the west, at the intersection described above, is a collection of buildings constructed circa 1900. The Odd Fellows Hall and the O. N. Hirsch Building are on the south side of Fremont Boulevard. On the south side of Bay Street are Clark's Hall, the W. W. Hirsch Building, built in 1897, and four other commercial buildings of the period. On the north side of Washington Street is a row of one- to three-story structures which appear to contribute to this commercial core. At the intersection of Washington Boulevard and the SPTCo tracks is a long, one-story, rectangular wooden building with a gable roof and a variety of windows, largely overgrown with vines. The

---

<sup>1</sup> Wood, 816-821, 835. Hoover et al., 11-12.



### 3.9 Cultural Resources

Official 1878 Atlas Map of Alameda County indicates that the Southern Pacific depot sat across the street on the south side of Washington Boulevard; this structure likely served as a maintenance or freight building associated with the depot and is representative of small rural railroad buildings dating from circa 1900. The City of Fremont has designated this area as the Irvington Historical Park, but it is not in the project corridor.

Irvington historical resources located within the project study area include:

**Gallegos Winery at Washington Boulevard and Osgood Road.** This historical property, which consists of the ruins of the nineteenth-century Gallegos Winery, is situated at the proposed Irvington BART Station location. A section of semi-cylindrical brick walls is built into the hillside on the northern portion of the property and other building ruins are present. They are the remains of a winery called Loma Linda, operated by the Gallego family in the latter part of the nineteenth century; the winery building was destroyed in the 1906 earthquake. Though architectural integrity of the structures has been lost, the historical value of the ruins has been recognized by the City of Fremont. These historical ruins would likely meet California Environmental Quality Act (CEQA), Appendix K criteria, as an important historic resource.

**The William Y. Horner House at 3101 Driscoll Road.** This two-and-one-half story, wood-frame house is clad in lapped siding with an irregular plan and a cross-gabled roof. The style of the house is Classical Revival with touches of Gothic Revival in the windows of the three gable-ends of the main part of the building, which have heads with pointed arches. The roof has a boxed, molded cornice with returns; windows in the original part of the house have straight heads, some with drip moldings, and are typically double-hung with four-over-four lights. The house has the tall, narrow proportions of 1860s houses. An early addition provided a two-and-one-half story rear wing, which is in the same style as the original house. A later one-story, rear addition is not stylistically compatible but does not affect the integrity of the building because it is not visible from the front (an 1873 photograph indicates that both these additions were made prior to that year). The house also retains the impression of its historic setting with some mature landscaping and palm trees as well as a wood, picket fence across the front of the yard.

The Horner House, depicted on the Official 1878 Atlas Map of Alameda County and listed on the Fremont Primary Historical Resources Inventory, appears to date from circa 1865. Because it retains a high degree of architectural integrity and is associated with an important family in Alameda County, the house would meet CEQA criteria as an

### 3.9 Cultural Resources

important resource and is potentially eligible for listing on the National Register of Historic Places.

**The Ford House at 41753 Osgood Road.** The Ford House is a one-and-one-half story, wood-frame, Queen Anne cottage, circa 1895, with a rectangular plan, a porch across the front and decorative shingle work in the gable end. Although the house is listed on the Fremont Secondary Historical Resources Inventory, it is a common type in the San Francisco Bay Area and does not appear to meet CEQA requirements as an important historical resource.

**The McCollough House at 42270 Osgood Road.** The McCollough House is a two-story, wood-frame house with an L-plan and gable roofs. A one-story front porch occupies the ell and a bay with windows and a gable roof is canted off the south corner of the ground floor on the front. The double-hung windows have straight, molded heads. A one-story, wooden, former stable with a gable roof and a small central tower stands near the house on the other side of the driveway. Although this circa 1895 house, which is listed on the Fremont Secondary Historical Resources Inventory, appears to have been renovated and given a new foundation, it retains a high degree of architectural integrity and will likely meet the CEQA criteria as an important resource.

**The Dr. J. H. Durham House at 43078 Osgood Road.** This is a two-story, rectangular plan, stuccoed house with a hip-and-gable roof and a one-story, arcaded front porch in the center of the facade. The house is a simplified example of the Craftsman style. Although the house is listed on the Fremont Secondary Historical Resources Inventory as dating from 1889, field inspection indicates a date of circa 1910. Because it is a common house type in the San Francisco Bay Area, it does not appear to meet CEQA criteria as an important structure.

**Warm Springs.** Although the study corridor does not run through the historic section of Warm Springs, there are some houses that appear to date from the nineteenth and early twentieth centuries. With the exception of the Warm Springs Grammar School, most of these buildings are simple vernacular structures without architectural distinction and many have been considerably altered.

**Warm Springs Grammar School at 47370 Warm Springs Boulevard.** This structure was built in the Mediterranean Revival style, with a stuccoed exterior, and a long rectangular layout composed of a central square tower with a pyramidal tiled roof flanked by two

### 3.9 Cultural Resources

wings of different heights with tiled gable roofs. The building has a variety of windows and an elaborate entrance with ornament in cast plaster. This school is listed on the Fremont Primary Historical Resources Inventory and was built in 1936 by well-known Oakland architect, Henry C. Smith. Although the building is a representative type, it is not architecturally distinctive nor is it the work of a master and, therefore, it does not appear to meet CEQA criteria as an important historical resource.

There are a number of additional buildings scattered throughout the entire project area that appear to be more than fifty years old; all are common building types of no particular architectural distinction. Most of these buildings, which are located on Osgood Road, Warm Springs Boulevard, Driscoll Road, Main Street and Washington Boulevard, are residential structures that have lost architectural integrity through alterations. These structures are not listed individually as they have no historical standing on local or state registers. Project-related research revealed no evidence of historical importance through association with persons or events. Other buildings in the project area are post-1945 structures.

#### 3.9.2 DIRECT (OPERATING) IMPACTS AND MITIGATION

**Proposed Project Impacts.** No operational impacts to cultural resources are anticipated.

**Alternative 4.** The relocation of railroad tracks within the existing railroad alignment will not cause construction-related impacts to cultural resources. The historically-important Horner House on Driscoll Road is located close to the UP line and reportedly experiences potentially damaging vibration from current railway operation. Alternative 4 calls for the movement of UPRR tracks to the west of their present alignment and the SPTCo tracks to the east of their present alignment. According to Section 3.13, Noise and Vibration, no increase in vibration levels will result from railroad track realignments; therefore, no Alternative 4 project-operation impacts to the Horner House or other cultural resources are anticipated.

**Mitigation.** No mitigations are required.

**Alternatives 5 through 11.** No operational impacts to cultural resources are anticipated.

### 3.9.3 CONSTRUCTION IMPACTS AND MITIGATION

**Proposed Project Impacts.** The Proposed Project could result in significant impacts to the following cultural resources:

**CA-Ala-343.** This prehistoric site could be impacted by construction of the BART extension southeast of the Fremont BART Station. The proposed BART alignment passes through the known location of this site and it is possible that cultural deposits, as well as Native American burials, would be disturbed or destroyed. Options involving the use of aerial structures and embankments are proposed through the site area; either option could impact the cultural deposits. Particularly severe impacts could result from Central Park Subway Design Options 1 and 2S if unknown, subsurface components of CA-Ala-343 extend to Stevenson Boulevard and the subway portion of the project. Construction-related impacts to CA-Ala-343 may also result from the construction of an embankment across South Tule Pond and replacement of associated stormwater storage capacity.

#### Criteria for Assessing Significance of Impacts on Cultural Resources

*Potential damage to an important archaeological or historical resource resulting from the proposed BART Extension Project would be considered a significant impact. An important cultural resource is defined in Appendix K of the CEQA guidelines as one which:*

- *is associated with an event or person of recognized significance in California or American history, or recognized scientific importance in prehistory;*
- *can provide information which is both of demonstrable public interest and useful in addressing scientifically consequential questions;*
- *has a special quality such as oldest, best example, largest or last surviving example of its kind;*
- *is at least 100 years old and possesses substantial stratigraphic integrity; or*
- *involves important research questions that historical research has shown can be answered only with archaeological methods.*

*Archival research and field surveys have resulted in the identification of known prehistoric and historic archaeological resources and properties of historic architectural importance within the project area.*

The site appears to meet CEQA Appendix K criteria as an important cultural resource. The site can provide information which is useful in addressing scientifically consequential questions regarding prehistoric settlement patterns; subsistence, trade and economic practices; social and cultural customs (i.e., burial practices); and cultural exchange. Also, the site can provide information that is of demonstrable public interest insofar as

### 3.9 Cultural Resources

prehistoric human burials are present. Public interest in the disposition of prehistoric cultural deposits and burials has generated state and local legislative requirements in dealing with such cultural resources that are subject to adverse impacts. The local Native American community, as a public entity, has a very focused and well-established interest in the protection and proper disposition of prehistoric burials and archaeological sites in general.

A focused subsurface archaeological testing program would be designed to determine the depositional integrity and the cultural complexity of deposits at specific locations that will be affected by the Proposed Project (as per CEQA Appendix K guidelines). These investigations would be conducted by qualified professionals experienced in South Bay prehistoric studies. The testing programs should be conducted within the context of appropriate research considerations and should result in a detailed technical document that defines the exact project impacts to the site and presents a project-specific mitigation program for addressing those impacts.

**The Gallegos Winery.** The brick and sandstone winery ruins are embedded in the hillside at the east end of the BART Irvington Station parking lot. The structural ruins could be adversely affected by excavation, grading and filling activities associated with constructing the station parking lot and facilities. The operation and parking of heavy equipment and vehicles on or immediately adjacent to ruin features could impact the resource as well.

The same construction activities could adversely impact important subsurface historic archaeological deposits at the parking lot location.

The winery site is locally regarded as a significant historical resource and would likely meet the CEQA Appendix K criteria as an important historic resource. Construction impacts would therefore be significant in nature.

Additionally, a historic archaeological component associated with the winery may be present in the soils surrounding the structural ruins; such deposits could be found anywhere in the area bound by Osgood Road and Washington Boulevard. Archaeological testing would reveal the presence and importance of such resources. These investigations could be conducted within the context of appropriate historical research considerations and CEQA Appendix K guidelines, and would result in a detailed technical document that defines exact impacts and presents a comprehensive mitigation program.

### 3.9 Cultural Resources

**Other historical properties.** Identified resources including those in the Irvington Historical Park, the Horner House on Driscoll Road and the structures on Osgood Road and Warm Springs Boulevard, will not be affected by Proposed Project construction.

**Mitigation.** The following measures are recommended for purposes of reducing construction-related impacts to the less-than-significant level.

**CA-Ala-343.** In the event that the focused archaeological testing program reveals important site deposits with good depositional integrity, alternatives are available for mitigating construction-related impacts:

- Preservation of cultural deposits by covering or "capping" the site with a protective layer of fill. This could be a very good way of mitigating potential impacts if BART tracks are placed on an embankment; protective fill can be placed on the site, followed by track grade and construction. Archaeological monitoring during construction would be required.
- In circumstances where important archaeological deposits will be impacted by construction of aerial structure footings, data recovery through excavation would be the appropriate mitigation. This measure would consist of the methodical excavation of those portions of CA-Ala-343 that will be adversely impacted. The work would be accomplished within the context of a detailed research design and in accordance with current professional standards. The program would result in the extraction of sufficient volumes of archaeological data to address important South Bay research considerations. The excavations would be accomplished by qualified professionals and detailed technical reports would result. Archaeological monitoring during construction would be required.

In considering subsurface testing and excavation of prehistoric archaeological sites, it is important to obtain the counsel and approval of the local Native American community regarding all aspect of the programs, including the treatment of cultural materials and particularly the removal, study and reinternment of Native American burials. All arrangements concerning these matters would be worked out prior to beginning the archaeological programs and would be incorporated into contract agreements.

### 3.9 Cultural Resources

**The Gallegos Winery.** The potential for impacts to the historic winery ruins will be avoided by preserving the ruins in their present state. Methods of stabilization of the structural features will be investigated and the entire resource incorporated into the east end of the proposed Irvington Station parking lot. An appropriate barrier can be placed between the parking lot and the ruins, so that the resource is protected and at the same time visually available to the public. An information plaque or other educational device that explains the nature and importance of the historical site can be placed at the barrier.

In the event that subsurface archaeological testing reveals an important historic archaeological component, alternatives are available for mitigating construction-related impacts:

- Preservation of the archaeological component by expanding the protected historic ruins area to include the archaeological deposits.
- If preservation is not feasible and disturbance of portions of the subsurface component is required to construct the parking lot, then data recovery through excavation would be appropriate; similar recommendations as presented for prehistoric sites regarding professional procedures and reporting, would apply. Archaeological monitoring during construction would also be required.

**Unexpected Finds.** In the event that unknown subsurface cultural deposits or features are encountered during construction, work in the immediate vicinity of the find would be halted, BART personnel would be informed, a professional archaeologist consulted and an appropriate course of action developed that is acceptable to all concerned parties. All such procedures will be conducted within the context of CEQA Appendix K cultural resources management requirements. In addition, BART will comply with all federal and state laws regarding impacts to Native American remains.

No construction-related impacts are anticipated for any of the Fremont Central Park Design Options, south of Stevenson Boulevard. Design Option impacts to CA-Ala-343 are discussed above.

**Alternatives 1, 2 and 3.** No construction-related impacts are identified and no mitigation measures are recommended.

### 3.9 Cultural Resources

**Alternatives 4 and 5.** Significant impacts to cultural resources would be the same as for the Proposed Project. Ca-Ala-343 and the Gallegos Winery site would be affected as discussed above. Mitigation measures for reducing the impacts to a less-than-significant level are the same.

**Alternative 6.** This alternative would result in construction impacts to CA-Ala-343 and mitigation recommendations would be the same as for the Proposed Project. Without the Irvington Station at Washington Boulevard, no construction impacts to the Gallegos Winery are anticipated.

**Alternative 7.** This alternative would result in construction impacts to CA-Ala-343 and mitigation recommendations would be the same as for the Proposed Project.

Several industrial and commercial buildings between Washington Boulevard and the southern terminus of the project would be removed as a result of locating the BART alignment east of the existing railroad right-of-way. All of the affected structures are post-1945 and have no historical attributes or importance.

**Alternative 8.** This alternative would result in construction impacts to CA-Ala-343 and mitigation recommendations would be the same as for the Proposed Project.

Historical properties have been identified on Osgood Road and Warm Springs Boulevard; only one property, the McCollough House at 42270 Osgood Road, may be an important historical resource. Construction of the aerial BART alignment over the roadway may cause minor-inadvertent impacts to these structures. Mitigation through deliberate avoidance of the properties during construction would reduce impacts below a level of significance and serve to preserve all the historical properties on the Alternative 8 alignment on Osgood Road and Warm Springs Boulevard.

Some industrial and commercial buildings will be removed where the BART alignment would extend from Warm Springs Boulevard to the existing railroad alignment at the South Warm Springs Station. All of the affected structures are post-1945 and have no historical attributes or importance.

**Alternatives 9 and 10.** These alternatives would result in construction impacts to CA-Ala-343 and mitigation recommendations would be the same as for the Proposed Project.



**Alternative 11.** Significant impacts to cultural resources would be the same as for the Proposed Project. CA-Ala-343 and the Gallegos Winery site would be affected as discussed above. Mitigation measures for reducing the impacts to a less-than-significant level are the same.

### 3.9.4 CUMULATIVE IMPACTS AND MITIGATION

**Proposed Project and Alternatives 4 through 11.** Long term cumulative impacts to cultural resources may result from an increase in residential and commercial development, which sometimes follows improvements to major transportation systems. Available land may become increasingly short in supply, bringing greater threats to archaeological sites. Older, historical structures may be further threatened with removal and destruction as the demand for higher-density development increases.

**Mitigation.** Public and private efforts to preserve and protect important prehistoric and historical resources can offset the potential for loss of these resources as a consequence of new development. Urban planning that provides for historic preservation, as reflected in the Fremont General Plan (adopted May 7, 1991) and CEQA Guidelines, can accommodate residential and commercial development and still preserve community-oriented historical heritage. Policies of the Fremont General Plan, as implemented, would mitigate cumulative impact. Policy LU 7.5 states that the City shall identify all historic and archaeological resources. The implementation action for this policy is to prepare an historic preservation plan consistent with the Secretary of Interior's standards.

### 3.9.5 RESIDUAL IMPACTS AFTER MITIGATION

**Proposed Project and Alternatives 4 through 11.** Less than significant residual impacts to CA-Ala-343 could occur after mitigation. Archaeological testing and excavation will result in the retrieval of scientific data and would diminish impacts to an acceptable level. However, not all archaeological deposits subject to construction-related disturbance would be excavated; consequently, residual impacts would occur. Archaeological monitoring during construction will therefore be required.

## **3.10 UTILITIES AND PUBLIC SERVICES**

### **3.10.1 SETTING**

The following is a discussion of the utilities and public services which potentially would be affected by the Proposed Project and Alternatives 4 through 11. Alternatives 1, 2 and 3 do not involve an extension of the Fremont BART line, and would not directly affect utilities or public services. The utility and public service systems analyzed include fresh water, storm water and sewer systems, natural gas, electrical, communications, and petroleum pipelines.

#### **Hetch Hetchy System**

San Francisco obtains water and power from the Hetch Hetchy Aqueduct system. The Hetch Hetchy aqueduct system within the Fremont area consists of a network of water pipelines, a pumping station, and overhead electrical transmission lines. The location of the pumping station is shown on Figure 2-7. The existing Hetch Hetchy water pipelines in the vicinity of the Proposed Project run in the east-west direction and traverses the proposed alignment just north of Paseo Padre Parkway. All pipelines are contained within the existing 80-foot Hetch Hetchy right-of-way. A study is being performed for the construction of a new pipeline within the existing right-of-way within the next 20 years. The pumping station is located along the north side of the pipelines north of Paseo Padre Parkway between the SPTCo and UPRR tracks.

Overhead electrical transmission lines are located within the same right-of-way. These are rated 115KV and supported by 90-foot towers. At the location where the right-of-way crosses the Proposed Project alignment, the lines maintain a minimum 34-foot clearance from the existing level of SPTCo and UPRR tracks. The clearance requirement is controlled by the State Industrial Safety Division General Order 95 (GO 95). Within the next two to 15 years, the existing lines will be upgraded to a 230KV rating. In conjunction with the Hetch Hetchy upgrade, the support towers may need to be modified.

#### **Pacific Gas and Electric**

The existing natural gas line network in the Fremont area is operated and maintained by Pacific Gas and Electric Company (PG&E). The Proposed Project alignment would cross the existing gas lines at several locations, usually where the alignment has a crossing with an existing roadway. These locations include the alignment's crossings at Paseo Padre Parkway, Blacow Road (slightly north), Norfolk Road, Savannah Road, Prune Avenue, Lopes Court, Warren Avenue, Page Avenue and Kato Road.

### 3.10 Utilities and Public Services

The gas-line pipe sizes range from 8 to 36 inches in diameter. At some locations concrete casings and/or other protective coverings have been installed over the existing pipelines. There are no planned improvements to the existing gas line system in the near future.<sup>1,2</sup>

The existing electrical utility system consists of 12KV and 21KV rated transmission lines supported by a series of wood poles and 60KV, 115KV and 230KV trunk lines which are supported by towers. Although the 12KV and 21KV lines cross the proposed BART alignments in many locations, their relatively uncomplicated relocation makes them of minor significance. The trunk line crossings with the proposed BART alignments occur in the vicinity of Driscoll Road and Durham Road. At present the lines maintain minimum clearance of 34 feet over the SPTCo and UPRR tracks, and a minimum clearance of 25 feet in other areas as controlled by the State Industrial Safety Division General Order 95 (GO 95).

#### Communication Utilities

Pacific Bell, US Sprint, MCI, and Tele-Communications Incorporated Cablevision (TCI) operate and maintain communication lines near the alignment of the Proposed Project.

**Pacific Bell.** The underground Pacific Bell lines in the project area include a mainline parallel to the SPTCo tracks on the west side from Stevenson Boulevard to the Alameda/Santa Clara County line. There are line crossings also at Adams Avenue, Warren Avenue, Page Avenue, and Kato Road. The size of conduits and depth of cover of these lines are undetermined at the present time.<sup>3</sup>

**US Sprint.** The US Sprint system consists of six 2-inch conduits with fiber optic cables running parallel to the east side of the SPTCo railroad tracks through the project area. The Proposed Project is expected to cross these cables in the vicinity of Central Park.<sup>4</sup>

---

<sup>1</sup> Dale Simpson, 1991, Pacific Gas and Electric, personal communication, April 12.

<sup>2</sup> Steve DeBacker, 1990, Pacific Gas and Electric, correspondence to BATC, including gas plats, June 29.

<sup>3</sup> Peter H. Walde, 1989, Pacific Bell, letter and plan markups to BATC, June 14.

<sup>4</sup> John Marchuk, 1991, US Sprint, personal conversation April 12; letter and plan markup to BATC, July 27, 1989.

### 3.10 Utilities and Public Services

**MCI.** The MCI system consists of a fiber optic cable parallel to the UPRR tracks on the east from north of Paseo Padre Parkway to just north of Durham Road. The Proposed Project would cross the MCI cable in the area of Central Park. The cables are placed in either 4-inch galvanized steel or PVC conduits depending on geographical location. All conduits typically have a 42-inch minimum cover, except where a 24-inch minimum clearance is maintained in ballast under railroad tracks.<sup>1,2</sup>

**TCI Cablevision of California, Inc.** The TCI underground television cable runs along Walnut Avenue. The Proposed Project would cross over the existing cables on Walnut Avenue between Gardino Drive and Civic Center Drive.<sup>3</sup>

#### **Petroleum Pipelines**

Santa Fe Pacific Pipelines and Chevron Pipeline Company have petroleum pipelines in the Proposed Project corridor.

**Santa Fe Pacific Pipelines.** Within the project area from Paseo Padre Parkway to the south of Kato Road, Santa Fe Pacific Pipelines (SFPP) currently operates and maintains a 10-inch welded steel pipe. The pipeline follows Driscoll Road from Mission Boulevard to just north of Washington Boulevard, where it crosses the UPRR tracks. From there, the pipe runs parallel to the SPTCo tracks on the east side to the Alameda/Santa Clara County line. An 8-inch welded steel pipeline leased from the Shell Oil Company runs parallel to the 10-inch pipe.<sup>4</sup> The pipelines have been included in a listing of critical utilities crossing the Hayward Fault.<sup>5</sup> The SFPP guidelines require a minimum cover of six feet under heavy loading conditions. The existing pipes have been placed without special cover or casing. There is no plan to modify or improve the present arrangement within the next ten years.<sup>6</sup>

---

<sup>1</sup> Dean Scurries, 1991, MCI, personal conversation, April 12.

<sup>2</sup> Gerald D. Siegel, 1989, MCI, letter and plan markup to BATC, August 2.

<sup>3</sup> Gary Azevedo, 1991, TCI Cablevision of California, Inc, personal communication, April 12; and letter to BATC and plan markup, July 12, 1989.

<sup>4</sup> Joe Whitelaw, 1991, Santa Fe Pacific Pipeline, personal conversation, April 11.

<sup>5</sup> California Department of Conservation & Division of Mines and Geology, 1987, Earthquake Planning Scenario - Hayward Fault Scenario, Special Publication 78.

<sup>6</sup> George Reed, 1991, Santa Fe Pacific Pipeline, personal communication, April 12.

### 3.10 Utilities and Public Services

**Chevron Pipe Line Company.** The portions of the Bay Area Products Line (BAPL) in the Fremont area consist of petroleum pipelines currently operated and maintained by the Chevron Pipe Line Company. Within the Proposed Project corridor, the existing 8-inch pipe runs parallel to and east of the Union Pacific railroad track from Grimmer Boulevard south to Kato Road. Between Grimmer Boulevard and Prune Avenue, some branch pipes have been abandoned in place.<sup>1</sup> The pipeline is included in a listing of critical utilities crossing the Hayward Fault.<sup>2</sup> At this time there are no planned improvements to the existing system in the near future.<sup>3</sup>

#### Sewer

The existing sewer network, under the jurisdiction of the Union Sanitary District, crosses the Proposed Project and all of the BART alternative alignments in several locations. In the case of Alternative 8, a sewer line is located directly under the proposed alignment. The system consists mainly of PVC, clay, and asbestos pipes; and operates via gravity flow. There exist minor feeder lines crossing the UPRR and SPTCo tracks. These range from 10 to 12 inches in diameter and are located near the railroad crossings at Paseo Padre Parkway, Washington Boulevard, and Warren Avenue.

The replacement of the sewer segment on Osgood Road between Mission Boulevard and Blacow Road recently has been completed. No other improvements are planned to occur within the next five years.<sup>4</sup>

#### Water

In the Fremont area, the Alameda County Water District (ACWD) operates and maintains the local water network serving the area. The water district currently is developing a 25-year plan for improvements to the existing systems, but details of the improvement plan are currently unavailable. In 1988-89, under drought conditions, the Water District's supply of 48,300 acre-feet was received from three main sources: 31,300 acre-feet from the State Water Project (65%), 10,000 acre-feet from the San Francisco Water Department (20%), and 7,000 acre-feet from local run-off and groundwater.<sup>5</sup>

---

<sup>1</sup> R.A. Noreen, 1989, Chevron Pipe Line Company, letter and plan markups, 1989.

<sup>2</sup> California Department of Conservation & Division of Mines and Geology, 1987, op. cit.

<sup>3</sup> Kent Billeter, 1991, Chevron Pipeline Company, personal communication, April 11.

<sup>4</sup> Rich Davis, 1991, Union Sanitary District, personal communication, April 11.

<sup>5</sup> City of Fremont, *Fremont General Plan*, Preliminary Draft II, dated March 1991.

### **Storm Drain**

In the Fremont area, the Alameda County Flood Control and Water Conservation District (the "District") operates and maintains a series of drainage ponds, basins, and culverts. The systems within the project corridor, and their respective impacts and mitigations are listed in Section 3.4, Hydrology. There have been no funds set aside for improvements to the drainage systems listed in the Hydrology Section in the near future. However, additional up stream drainage needs due to development will increase the downstream capacity requirements for those drainage systems affected by the BART Warm Springs extension.<sup>1</sup>

#### **3.10.2 BACKGROUND ON UTILITIES IMPACT ANALYSIS**

The analysis concentrates on major utility lines because of the potentially substantial affects on the surrounding community and the large costs that can occur if major relocation of a utility is necessary. In most instances, the relocation of minor utility lines are not expected to be an issue, based on discussions with the various utilities. In fact, only Alternative 8, which runs on an aerial structure along Osgood Road, involves a number of potential impacts to minor utilities.

With the exception of San Francisco Water Department, all of the utility companies mentioned in the discussions below have indicated that they do not expect any significant impacts that cannot be mitigated. In addition, all utility agencies stated an intent to work with BART and the engineering design team to resolve conflicts. BART has agreements with PG&E, Pacific Bell, and EBMUD which establish the guidelines for necessary utility relocation. These agreements are amended periodically, and any BART-related work involving the utilities' facilities must strictly follow guidelines set forth in the agreements. Although no such agreement currently exists between BART and the San Francisco Water Department, which is supplied by the Hetch Hetchy aqueduct system, the District intends to work directly with the BART team to avoid any conflicts.

The BART engineering design team has established the "Warm Springs Extension (WSX) Project Master Schedule". Contained within this schedule is an item identifying the time necessary for the design and relocation of utilities. Certain items brought forth in the following

---

<sup>1</sup> Jack Lindley, 1991, Alameda County Flood Control and Water Conservation District, personal communication, April 11.

### 3.10 Utilities and Public Services

sections would serve as a reminder of the necessary coordination with each of the affected utility companies.

The concern about stray electrical currents has been mentioned several times in this section at the request of the utilities most effected. Stray electrical currents are generated through the operation of BART. Utility lines near the Proposed Project and any of the build alternatives can be affected by stray currents, especially those utilities that run parallel to the BART tracks. In particular, stray currents may accelerate the corrosion of metal pipes through the process of electrolysis. Standard precautionary measures can be taken to reduce the effects of stray electrical currents. BART has established design criteria to address stray current issues.<sup>1</sup>

#### Criteria for Assessing Significance of Impacts to Utilities

*A significant impact was found to occur where a utility would be substantially affected by the construction or operation of the Proposed Project, resulting in the need for new utility systems or substantial alterations to existing systems.*

*An important utility is defined in Appendix I of the CEQA guidelines as:*

- a. Power or natural gas*
- b. Communications systems*
- c. Water*
- d. Sewer or septic tanks*
- e. Storm water drainage*
- f. Solid waste disposal*

#### 3.10.3 IMPACTS AND MITIGATION MEASURES OF PROPOSED PROJECT

##### Direct Impacts

**Hetch Hetchy System.** Under the Proposed Project, a BART extension would cross the Hetch Hetchy pipelines and pump station right-of-way and cross under the power line. A significant impact would occur if the Proposed Project requires the relocation of the mainline piping and/or the pump station controls and piping manifolds. A significant impact also would occur if adequate clearance for the mainline piping and access to the piping was not maintained.

Future existence of stray electrical currents related to BART operation may have adverse effects on the pipelines. It also should be noted that no bridge abutment or similar structure of any kind should be located near the pipelines.<sup>2</sup>

---

<sup>1</sup> Bay Area Transit Consultants, 1990, "BART Extensions Program Design Criteria, Civil", Vol. III, Part D, Corrosion Control I, p 7-8.

<sup>2</sup> Rahmat Zandian, 1991, San Francisco Water Department, personal communication, April 11.

### 3.10 Utilities and Public Services

**Pacific Gas and Electric.** The BART track ballast, structures, and associated improvements may result in insufficient clearance of the existing gas pipe and electrical transmission line locations. The future existence of new BART-related stray electric currents may have an adverse effect on metal pipes. PG&E has sufficient supplies to meet the future needs of the Proposed Project and the alternative alignments.<sup>1</sup>

**Communication Utilities.** The alignments of the Proposed Project and Alternatives 4 through 11 present potential conflicts during construction with the existing communication lines at the crossing locations mentioned above.

The BART track ballast, structures, and associated improvements may result in insufficient clearance from the existing conduit locations, and the future existence of electric currents in the area may have an adverse effect on the lines within metal conduits if precautionary measures are not taken. No stray current effects are expected to have a significant impact on the fiber optic cables.

**Petroleum Pipelines.** The final design of the Proposed Project or any build alternative will ultimately determine whether the pipelines will need to be relocated or their grade adjusted. In addition, the placement of new BART track ballast, structures and associated improvements may result in insufficient clearance from the existing pipeline locations. The future existence of stray electric currents generated by BART trains may have an adverse effect on the metal pipe if precautionary measures are not taken. The planting of deep-rooted vegetation for landscaping purposes could also impact the integrity of the pipeline.

**Sewer.** Although there are inadequate capacities of the sewer collection system in some areas of Fremont, it is not expected that the Proposed Project or any build alternative would significantly impact the existing sewer network.

**Water.** The construction of the Proposed Project and Alternatives 4 through 11 presents conflicts with the existing water systems where they cross the BART alignment. Relocation and adjustments of grades may be necessary to maintain adequate protective coverings and clearances. The future presence of stray electrical currents due to the new BART operations in the vicinity of water lines will be a concern.

---

<sup>1</sup> Dale Simpson, 1991, Pacific Gas & Electric, personal communication, April 12.



### 3.10 Utilities and Public Services

Water use required by BART are limited to the station facilities, (landscaping, bathroom facilities and drinking water fountains) and a proposed train car washing facility.<sup>1</sup> The BART car washing facility is expected to wash 130 cars per day using a water reclamation process that requires only 5 gallons of make-up water to be used for each car per each washing. Total amount of daily water consumption expected for this car washing facility will be just under 1 unit (750 gallons).<sup>2</sup>

Water consumption for the Proposed Project and Alternatives 4 through 11 is expected to be low, there is no significant impact to the local water supply.

**Storm Drain.** Construction of the Proposed Project or Alternatives 4 through 11 may result in a basin drainage demand scheme different from that of the existing drainage system. The possible existence of stray electric currents generated by BART is expected to have little or no effect on the existing drainage systems.

#### **Cumulative Impacts**

No cumulative impacts are associated with the Proposed Project or Alternatives 4 through 11.

#### **Construction Period Impacts**

**Hetch Hetchy System.** The construction process could temporarily affect the existing water lines, although at this stage of design the extent of conflict cannot be fully determined. From discussions with San Francisco Water Department engineering staff, construction conditions would be analyzed and evaluated in coordination with the project development team in order to determine the exact areas affected. There is a concern regarding the effect on the disturbance of protective ground covers of the pipelines. The operation of heavy construction equipment over the pipelines may cause excess loading.

**Pacific Gas and Electric.** During construction, the Proposed Project and the build alternatives would present potential conflicts with the existing gas line network at the locations mentioned above. Depending on the final design, the pipelines may need to be relocated or their grades

---

<sup>1</sup> Station water usage is not expected to exceed 8.5 units per day (1 unit for domestic water use and 7.5 for irrigation). This value is based on water usage at other BART stations. Al Welchert, 1991, BATC, personal communication, June 1991.

<sup>2</sup> Roy Masfei, BART Manager of Extension Liaison for Electro-mechanical Facilities, personal conversation, June 4, 1991.

### 3.10 Utilities and Public Services

adjusted. Any excavation in these areas may affect the protective coverings currently in place. Operation of construction equipment may result in excessive loading on the pipeline covers. The planting of deep-rooted vegetation for landscaping purposes also may impact the integrity of the pipelines. Construction activities also may interfere with the clearance of the high-voltage lines, resulting in safety concerns for construction personnel and equipment.

**Communication Utilities.** Lines parallel to the Proposed Project also may be affected if the existing clearance is disturbed. Depending on the final design of the adopted project, the conduits may need to be relocated or their grades adjusted. Any excavation in the areas of potential conflict may affect the protective covering currently in place. Operation of construction equipment may result in excessive loading on the conduit cover. The planting of deep-rooted vegetation for landscaping purposes also may impact the integrity of the conduits.

**Petroleum Pipelines.** The construction process of the Proposed Project and any build alternative present potential conflicts with the existing SFPP pipeline at the crossing location near Washington Boulevard. Portions of the pipeline parallel to the Proposed Project alignment also may be affected. Excavation in the area may adversely reduce the required cover for heavy loading conditions.

**Sewer.** Some disturbance to the feeder line crossings may result from earthwork in the area during construction; however, with proper involvement by Sanitary District staff the conflict would not be significant.

**Water.** Excavation or filling in any part of the identified areas during BART construction will affect the depth of cover of existing pipelines. Pipeline relocations or adjustments of grades may be necessary to accommodate the BART design. Any disturbance to the existing system will result in interruption of service.

**Storm Drain.** As discussed in Section 3.2, Hydrology, excavation or filling in any part of the identified detention areas during the BART construction will affect the storm drain storage and flow capacity of the system. Culvert relocations or adjustments of grades may be necessary to accommodate the BART design. Significant impacts to the storage and flow capacity of the system will occur unless interim drainage diversion systems are provided and construction is scheduled during the dry season.

**Mitigation Measures**

**Hetch Hetchy System.** Significant impacts to the Hetch Hetchy water system may be avoided if the staff of San Francisco Water Department is consulted early in the engineering design process in order to coordinate key elements of the design, such as locations of structural columns, at-grade track ballast, subway structure or similar structures so as to maintain proper clearance and minimize potential effects on the pipelines.

BART's crossing of the San Francisco Water Department right-of-way also would be accomplished in a manner that would not constrain the future installation of additional pipelines. During construction, access would be provided for emergency purposes and maintenance repairs.

Precautionary measures will be provided at all potential areas of effect to safeguard against stray electrical currents related to BART operation, as long as the Proposed Project and pipelines continue to exist concurrently.

**Power Lines.** With regard to the Hetch Hetchy overhead power lines, the reconstruction of existing support towers or placement of new ones may prove necessary to meet minimum clearance requirements. Proper clearance from electrical transmission lines will be maintained.

**Pacific Gas and Electric.** PG&E has established strict regulations regarding the possible disturbances of its facilities for construction purposes. The exact location of the gas pipeline crossings would be ascertained prior to doing any work in the area, and this effort would be coordinated with PG&E staff.

Grading in the areas of potential conflict will be reviewed by authorized PG&E personnel to avoid conflict with protective coverings and the existing pipelines. This coordination also will take place prior to placing any new utility, landscape vegetation, and fencing. As previously mentioned, the relocation or adjustment of existing lines may prove necessary to maintain proper clearances. Additional protective coverings and casings may need to be placed before the operation of heavy construction equipment in some areas.

The reconstruction of existing support towers and placement of new ones may prove necessary to meet GO 95 requirements regarding clearances. In addition, the requirement for minimum clearance of the electrical lines over the BART tracks of 34 feet will be observed.

### 3.10 Utilities and Public Services

The construction staging process of the Proposed Project would account for access to the PG&E right-of-way for emergency purposes, maintenance repairs, and future improvements.

Metal natural gas pipelines would be protected against stray currents related to the future operation of BART. The electrical line clearance requirement also will be observed at all times. Proper clearance from electrical transmission lines will be maintained.

Consultation with appropriate PG&E staff in the engineering design process is necessary to minimize any potential conflicts resulting from implementation of the Proposed Project and Alternatives 4 through 11. The scheduling of BART construction should account for sufficient lead time required for the involvement of PG&E departments.

**Communication Utilities.** The exact location and elevation of the conduits must be determined prior to doing any work in the area, and this effort should be coordinated with the staff of all aforementioned parties. Grading in the areas of potential conflict will be reviewed by authorized personnel of these parties to avoid conflict with protective coverings and the existing conduits. This coordination also would take place prior to placing any new utility, landscape vegetation, and fencing. As previously mentioned, the relocation or adjustment of existing lines may prove necessary to maintain proper clearances. Additional protective coverings and casings may need to be placed before the operation of heavy construction equipment in some areas.

Standard precautionary measures to safeguard cables from stray electric currents related to the future operation of BART would be provided. The construction staging process of the Proposed Project will account for access for emergency purposes, maintenance repairs, and future improvements.

Early consultation with appropriate staff of all parties referenced above in the engineering design process would be done to minimize any potential conflicts resulting from implementation of the Proposed Project or the other BART alternative alignments. The complicated transfer of customers data line required as a result of the relocation of the fiber optic communication systems is expected to have longer lead times than other utilities. The existing agreement with Pacific Bell and future agreements with the other fiber optic companies will enable BART to include sufficient lead time in the master project schedule to avoid conflicts.

**Petroleum Pipelines.** Plans for grading near petroleum pipelines should be reviewed by authorized SFPP personnel to avoid damage to the pipeline or its protective coating. SFPP has established guidelines regarding the possible disturbances of its pipelines for construction

### 3.10 Utilities and Public Services

purposes. The exact location of the pipeline would be ascertained prior to doing any work in the area, and this effort should be coordinated with SFPP staff. This coordination also would take place prior to placing any new utility lines, landscape vegetation, and fencing. As previously mentioned, the relocation or grade adjustment of existing pipelines may prove necessary to maintain proper clearances. Coordination with SFPP during the engineering design process would minimize potential impacts and lay the basis for a future agreement regarding any potential conflict.

Emergency access will be provided before and after construction of the Proposed Project. Standard precautionary measures to safeguard against possible stray electric currents related to BART operation would be provided.

**Sewer.** Interim sewer lines and/or drainage should be provided to avoid flooding if any change or improvement to the existing system proves necessary. Work on the sewer systems would be scheduled to avoid periods of peak flow. It is essential that the construction staging process of the BART project accounts for access to the sewer right-of-way for emergency purposes, maintenance repairs, and future improvements.

In addition, it is recommended that the Union Sanitary District be directly involved in the engineering design process in order to minimize conflicts with implementation of the Proposed Project. The Sanitary District has a policy that will not allow sewerage-lift stations, which may result from the relocation of pipelines associated with the BART improvements. Therefore, design of all relocated sewer lines would be coordinated with the Sanitary District.

**Water.** At BART alignment crossing locations, the relocation and adjustment of the grades of existing facilities may be necessary. Thorough involvement of the ACWD staff is essential during the engineering design process to ensure that potential conflicts will be minimized.

Emergency access before and after construction of the Proposed Project also will be provided. The placement of new BART track ballast, structures or related improvements must have adequate clearance from existing facilities. Where appropriate, precautionary measures will be used to safeguard water pipelines from stray electric currents. In certain cases, steel pipes may need to be electrically isolated by 300 feet on each side of the BART track. Use of insulation flanges and anode wells should be considered for older steel pipe crossings. It will be necessary to maintain the precautionary measures required to safeguard against stray electrical current as long as the Proposed Project and pipelines exist concurrently.

### 3.10 Utilities and Public Services

During the final design of the Proposed Project BART will consider and coordinate construction with the future upgrades of the existing water systems as defined in the ACWD 25-year improvement plan.

**Storm Drain.** At crossing locations the relocation and adjustment of grades of existing drainage facilities may prove necessary. Thorough involvement of District staff is essential during the engineering design process to ensure that potential conflicts will be minimized. Upgrade of existing drainage systems may be considered in anticipation of any change in the drainage demand scheme that may result after the completion of the BART construction.

Interim drainage can be provided to avoid flooding if any change or improvement to the existing systems prove necessary. Construction in the potentially affected areas should be done in the dry months to limit the demand on the interim drainage systems.

Emergency access before and after construction of the Proposed Project also will be provided. The placement of new BART track ballast, structures or associated improvements must provide adequate clearance from existing facilities. Future improvements to the system should consider standard protection measures where stray electrical currents related to BART operation may exist.

#### **Residual Impacts After Mitigation**

For all of the utilities mentioned above, precautionary measures should be maintained at all potential areas of effect to safeguard against stray electrical currents related to BART operation, as long as the Proposed Project and pipelines continue to exist concurrently. Sewer pipelines may require repeated maintenance if, during construction of the Proposed Project, gravity flow of the sewer lines are not preserved.

#### **3.10.4 IMPACTS OF DESIGN OPTIONS**

**Impacts.** The direct, construction, and cumulative impacts and mitigations associated with the Central Park design options, the Paseo Padre Design Option and the UPRR Relocation Design Option would be similar to those found in the Proposed Project, with the following exceptions.

### 3.10 Utilities and Public Services

Design Options 2A and 3 will have significant impact on the existing Hetch Hetchy electrical power lines in Central Park, due to standard clearance requirements.<sup>1</sup> For the Hetch Hetchy water system, conflicts would occur if the BART column supports for Design Options 2A and 3 were constructed over existing pump station pipe manifolds or main line piping. Design Option 2S may also result in some disruption to existing pump station facilities.

**Mitigations.** As in the Proposed Project, significant impacts to the Hetch Hetchy water system may be avoided by coordination during the engineering design process.

#### 3.10.5 IMPACTS OF ALTERNATIVES 1, 2 AND 3

Alternatives 1, 2, and 3 do not involve a BART Warm Springs extension. The alternatives would not lead to any direct or cumulative impacts on the utilities discussed in this section. While alternatives 2 and 3 involve some transportation infrastructure improvements, any related construction impacts to utilities would be discussed in project-specific impact analyses.

#### 3.10.6 IMPACTS OF ALTERNATES 4 THROUGH 7 AND 9 THROUGH 11

The impacts and mitigations associated with Alternatives 4 through 7 and 9 through 11 would be similar to those identified with the Proposed Project.

#### 3.10.7 IMPACTS OF ALTERNATIVE 8

**Direct Impacts.** Alternative 8 proposes an aerial alignment over and in the center of Osgood Road and Warm Springs Boulevard from Washington Boulevard to the proposed South Warm Springs station. This alternative would require the relocation of a majority of the minor utilities in this corridor. The utilities needing relocation include a sewer main running down the center of the street and the private laterals feeding into it; water lines; storm drain lines; natural gas; electricity; CATV lines; and traffic signals.

**Cumulative Impacts.** No cumulative impacts are expected for this alternative.

---

<sup>1</sup> Harry Heath, 1991, Hetch Hetchy Power, personal conversation, April 11.

### 3.10 Utilities and Public Services

**Construction Impacts.** During the reconstruction of the utilities and the construction of Alternative 8, access to the residential and commercial buildings will become limited. In addition, the relocation of the utilities mentioned above will cause intermitted interruptions in service to residences and commercial uses along this corridor.

**Mitigation Measures.** Careful coordination and planning will be performed with local residences and merchants to decrease the impacts during construction.

**Impacts After Mitigation.** No impacts are expected after mitigation.



## 3.11 SAFETY AND SECURITY

### 3.11.1 SETTING

#### Introduction

The safety records of rail transit are, in general, among the best of the common forms of passenger transportation.<sup>1</sup> Most accidents affecting BART passengers are due to slips and falls. Security issues include prevention of trespass into non-public areas and prevention of criminal and threatening acts. This section describes the key elements of BART's existing system safety program, BART's police department and BART's emergency plan. The following section identifies potential safety and security impacts of the proposed Warm Springs Extension project.

#### BART Safety Department

BART's System Safety Program Plan states that: "Safety is the major consideration in all (BART System) operations including planning, design, construction, testing, and maintenance of the rail transit system."<sup>2</sup>

The BART Safety Department is primarily responsible for ensuring that safety procedures are established and implemented throughout the San Francisco BART District and for monitoring safety performance. A key responsibility of the department is the execution of BART's System Safety Program Plan.<sup>3</sup> Implementation of the program includes the setting of safety goals and objectives and hazard identification, reduction and control activities throughout the system. The manager of the safety department has the authority to interrupt or cease passenger operations where it is determined that unsafe conditions exist.

The safety department is responsible for the monitoring of failures and accidents to identify deficiencies and instigate corrective measures, participating in design review of all new facilities to ensure consistency with safety and security standards, and developing an emergency response plan and conduct of drills to rehearse the proper responses to actual emergencies.

---

<sup>1</sup> In 1988 the death rate in the United States for passenger cars was 1.19 per hundred million miles. For buses the rate was 0.03, for scheduled airlines it was 0.01 deaths and for passenger rail trains it was 0.02. National Safety Council, 1990, *Accident Facts*, p. 90.

<sup>2</sup> San Francisco Bay Area Rapid Transit District, 1988, "System Safety Position Statement," *System Safety Program Plan*, January 1, Preface.

<sup>3</sup> *Ibid.*, p. IV-1.

The existing BART stations are designed to meet safety and security criteria. The public areas and parking lots are well-illuminated, and have been designed to avoid creating dark or remote passageways and areas that cannot be readily viewed or patrolled. BART recognizes that designs which promote public use and activity also minimize criminal activity and increases the likelihood that people will observe and report potential criminal activities. Stations are attended by BART personnel, patrolled by BART police and are kept clean and free of graffiti.

Aside from stations and parking areas, public access to BART's facilities and rights-of-way is strictly controlled. Non-public areas within the BART system, including the electrified rail alignment, train yard and maintenance facilities, are securely fenced or are located on aerial structures or in subways that are inaccessible to the public. Wherever the alignment is at-grade, warning signs are posted on the security fences adjacent to the tracks to halt trespassing and to warn of the dangers of entering the track area containing the electrified third rail.

#### **BART Emergency Plan**

BART's Emergency Plan<sup>1</sup> is the authoritative procedure to be used in an emergency event. It establishes standard policies and procedures for the "mobilization of BART and other public safety resources so that fast, controlled and predictable responses can be made to various types of emergencies. . . .<sup>2</sup> Response procedures for a full range of foreseeable types of emergencies are specifically addressed in the Emergency Plan. Included are specific response procedures for train fires, derailments, injuries or deaths on the right-of-way, right-of-way intrusions, earthquakes (of varying intensities occurring at varying times), high winds, flooding, gas leaks and toxic spills, bomb threats, explosions, and hostage situations. In all cases, the plan identifies the responsibilities of the involved persons and authorities (i.e., train operators, BART Central Control, BART police, the responding fire departments, etc.) and sets forth an operations plan for each type of emergency. The various operations plans address the initial fact finding and reporting procedures, communication requirements, evacuation and rescue procedures, emergency scene boundaries and restrictions, public information and related factors.

---

<sup>1</sup> San Francisco Bay Area Rapid Transit District, 1981, *Emergency Plan*, December, as amended.

<sup>2</sup> *Ibid*, p. I-1.

### **BART Police Department**

Police services on BART property are provided by the BART Police Department. BART police are sworn to uphold the laws of the State of California and the ordinances of the BART District. They are responsible for safeguarding the lives and property of persons who ride the system and protecting district property and personnel. The BART police department presently consists of 154 officers. BART operates nine vehicle beats and at least three train beats for each of its two police shifts. BART police also have a compliment of undercover officers to arrest automobile burglars and thieves.<sup>1</sup>

Incidents involving the BART police usually occur in the stations, on the platforms, and in the parking lots. Far fewer incidents occur on the trains. The most common serious crimes involve burglaries and auto thefts. Relatively few armed robberies or rapes are reported. BART police department's average response time is about 18.5 minutes and their emergency response time is 9.8 minutes.<sup>2</sup>

In the event of calls reporting crimes in progress, the City of Fremont police may be the first to respond unless BART police units are patrolling nearby. In such cases the Fremont police will apprehend suspects and secure the scene until the arrival of BART police.<sup>3</sup> In accordance with an existing agreement, BART police also use Fremont's facilities to book prisoners who are apprehended locally.

### **Fire Suppression**

In accordance with BART emergency procedures, the local fire departments are the primary responders in the event of a fire on the BART system. If there were a fire on the system or right-of-way within the City of Fremont, the Fremont Fire Department would be called. Under an existing agreement with all affected fire departments,<sup>4</sup> the local fire department would assume overall command of any fire emergency scene, with close liaison with BART Central Control.

---

<sup>1</sup> Deputy Chief Sharp, 1991, BART Police Department, personal communication, April 16.

<sup>2</sup> An emergency is any life threatening incident.

<sup>3</sup> Lt. James McKiernan, 1991, Fremont Police Department, personal communication, May 24.

<sup>4</sup> Bay Area Rapid Transit District, 1980, *Emergency Procedures Policy, Vital Fire Protection Equipment, Communications and Training Agreement*, July 28.

The Fremont Fire Department currently operates eight fire stations, with a complement of about 170 employees. An additional fire station is under construction in the northeast corner of Central Park, adjacent to Stevenson Place. In addition to fire suppression, the Fremont Fire Department is also the first response agency for medical treatment in the community. The department maintains a paramedic corps with emergency vehicles at all fire stations on a 24-hour basis. All of the Proposed Project is within the Fremont Fire Department's five minute response time zone.<sup>1</sup> The Fremont Fire Department generally conducts two fire drills per year at the existing Fremont Station.<sup>2</sup>

BART also maintains four emergency vehicles that are primarily fire trucks with the capability of traveling on either streets or BART rails. These vehicles are always available for fire emergencies anywhere within the system.

### 3.11.2 IMPACTS AND MITIGATIONS

#### Criteria of Significance

A significant impact on public safety and security could occur if a project were to pose a public safety hazard, result in unsafe conditions for employees, residents or surrounding neighborhoods, or if it had the potential to interfere with an existing emergency response plan.<sup>3</sup>

#### Impacts During Operations

The extension of the BART system for 7.8 miles (Proposed Project and Alternatives 6, 7, 8, 10 and 11) or for 5.4 miles (Alternatives 4, 5 and 9) and with one, two or three new stations would lead to increased demands for service to respond to accidents and criminal incidents. The number of additional auto thefts, burglaries and other criminal acts could be expected to increase generally in proportion the number of new stations, as most of the criminal activity

---

<sup>1</sup> EIP Associates, *Fremont General Plan 1990, Draft Environmental Impact Report*, September, 1990, pp. 3.11-13,14 and Figure 3.11-1.

<sup>2</sup> Mike Anderson, Battalion Chief/Support Services, Fremont Fire Department, personal communication, May 24, 1991.

<sup>3</sup> Based on the CEQA Guidelines, Appendix G (z) and Appendix I (II, 10)

### Section 3.11 Safety and Security

investigated by BART police is concentrated in station areas and parking lots. The frequency of traffic accidents on streets providing direct access to the main station sites would increase.

Increasing the length of the overall system by 8 percent to 11 percent (depending on the alternative selected) would also increase the risk of exposure to emergency situations, either from natural causes or incidents perpetrated by people. The Proposed Project and Alternatives 4 through 11 would involve three crossings of traces of the Hayward Fault, along which there is an estimated 23 percent chance of a major earthquake during the next 30 years. The potential impacts of an earthquake emergency are discussed, above, in Section 3.2.2.

The No Project and TSM alternatives (Alternatives 1, 2, and 3) would not involve any extensions of the BART system and would not increase BART's existing responsibilities for the maintenance of a safe and secure rapid transit system. Nor would any of these alternatives lead to potential needs for increases in BART's staff of safety and security personnel, including additional police officers.

**System Safety Planning.** The provisions of BART's existing System Safety Program Plan require active participation by the BART Safety Department in the design of system extensions. A safety engineer must review contract drawings and specifications for compliance with applicable safety codes. This includes provisions of the Uniform Building Codes, the National Fire Protection Codes and the California Public Utility Commission requirements. The safety department also monitors engineering testing and conducts safety technical audits of all new facilities and equipment to ensure that they meet the applicable safety standards prior to passenger operation and that they continue to meet these standards while in operation. All of the provisions of the System Safety Plan would apply to the proposed Warm Springs Extension in the same way they apply to the existing BART system.

Areas of known concern that would be addressed by the safety engineers as a part of the design review process would include the security fencing design along the at-grade alignments, train storage areas, and alongside transitions from subways to at-grade or aerial alignments. A secure right-of-way is of critical importance to BART because of the electric third rail and the high frequency and speeds of trains. Similarly, the safety engineers carefully review the design of the station entrances, exits, platforms and concourse areas for pedestrian safety. The design of the parking lots and bus/auto unloading zones is reviewed for pedestrian and vehicular safety and for quick and close access by fire trucks and ambulances. Landscaping and lighting plans for station areas also undergo a safety review.

### Section 3.11 Safety and Security

The Fremont Fire Department would also request an opportunity to conduct a review of the engineering plans for conformance with local fire protection codes. Of particular importance would be the availability of emergency exits from stations and subway sections, fire hydrant locations, and access points for fire and medical emergency vehicles.<sup>1</sup>

The application of the System Safety Plan during the design, construction and operation of the Warm Springs Extension would reduce the risks from unsafe or unsecure conditions and would provide management mechanisms for the correction of any problems that might occur. For these reasons, no significant system safety impacts are projected.

**Emergency Planning.** BART's Emergency Plan would also apply to the operation of the extension, just as it applies to the existing system. The potential addition of subways and depressed sections along the alignment within the City of Fremont (Design Options 1 and 2S, and the Irvington Station) would require additional training and emergency preparation work with the Fremont Fire Department, as there are no BART subways within the City at the present time. Similarly, training would be required to familiarize the Fremont Fire Department staff with the new stations and extended alignment within the City. There would be increased needs for coordination and for joint training exercises with the Fremont Fire Department. With project operation, increases in calls for paramedic service would also be expected.

The application of the existing Emergency Plan to the Warm Springs Extension would provide established emergency response protocols and regular training for the responding agencies. This would reduce the public safety risks and increase the potential for effective emergency management. No significant impacts are projected.

**Police Services.** The increased demands for service resulting from the additional stations and right-of-way would result in the need for increases in the staffing of the BART Police Department. One to two additional police beats would be required, depending upon the length of the extension and number of stations. Staffing each additional beat requires five additional officers.<sup>2</sup>

The addition of one to three BART stations within the city limits of Fremont would also increase the calls for back-up support from the Fremont Police Department, and would increase

---

<sup>1</sup> Norton Clark, 1991, Plan Check Engineer, Fremont Fire Department, personal communication, May 24.

<sup>2</sup> Deputy Chief Sharp, 1991.

calls for service at traffic accidents on streets providing access to new station sites. The impacts on both the BART and Fremont Police Departments are expected to be less than significant.

#### **Impacts During Construction**

The BART Safety Department would be responsible for implementing actions to insure the safety of workers and the work sites while the BART Police Department would work with the construction contractors to ensure the security of construction equipment and materials in the field during construction. The need for job site inspections to ensure compliance with CAL/OSHA orders and BART rules and procedures during construction could require temporary increases in the number of BART inspectors and safety engineers during the most active construction periods. Similarly, BART police patrols would be extended along the construction corridor during the construction period, potentially requiring an increase in police personnel. There could also be increased calls to the Fremont Police Department for lock-up support during the construction period. The impacts are not expected to be significant.

#### **Mitigation**

The existing System Safety Program Plan and Emergency Plan establish the plans and procedures for safety and security on a systemwide basis. Extending the system would not necessitate modifications to these plans. The applicable provisions of these plans, however, should be fully implemented during construction and operation of the proposed extension. To the extent required, BART would increase the staffing of the safety department and the police department to provide the necessary reviews, inspections, training exercises, patrols and emergency response capabilities required to implement these plans along the proposed extension. The Fremont Fire Department should be given the opportunity to comment on the engineering plans for the Warm Springs Extension as they are developed, and BART's safety engineers should review the fire department's recommendations for design modifications that would further BART's system safety goals.

Implementation of these measures would reduce the potential safety and security impacts to acceptable levels.

## 3.12 TRANSPORTATION

This section begins with a description of the current transportation setting in areas which would be affected by the implementation of the Proposed Project or one of the alternatives. The local setting includes the areas around the proposed Irvington, Warm Springs and South Warm Springs stations, and around the existing Fremont station. Various elements of the regional transportation system, some of which would provide access to the stations, are also examined.<sup>1</sup>

CEQA and case law regarding Environmental Impact Reports (EIRs) require that an EIR measure the potential effects of a project against the conditions which currently exist in the project area at the time the EIR is prepared. With a major public rail transit project such as the proposed Warm Springs Extension, several years may elapse before the project moves from the project planning stages (when an EIR is prepared) into actual operation. For this reason, the impacts of the Proposed Project and the alternatives are compared not only to existing conditions, but also to conditions in 1998, when passenger service would begin.

Similarly, mitigation measures for the impacts are developed for year 1998 transportation conditions. In some instances, the mitigations proposed for 1998 conditions are the same as those which would be needed under existing conditions. In other cases, however, the mitigations proposed for 1998 will be greater than those which would be needed under existing conditions. This approach is designed to achieve the most realistic level of mitigation needed to reduce the Proposed Project's impacts.

The discussion of cumulative impacts for traffic effects is based on the "summary of projections" approach using the Fremont General Plan rather than a "list-based" approach where all the past, present and reasonably anticipated future projects are listed, with their effects reflected in the environmental discussion. (See Section 3.1.2 for additional information on the summary of projections approach for cumulative impact analysis.)

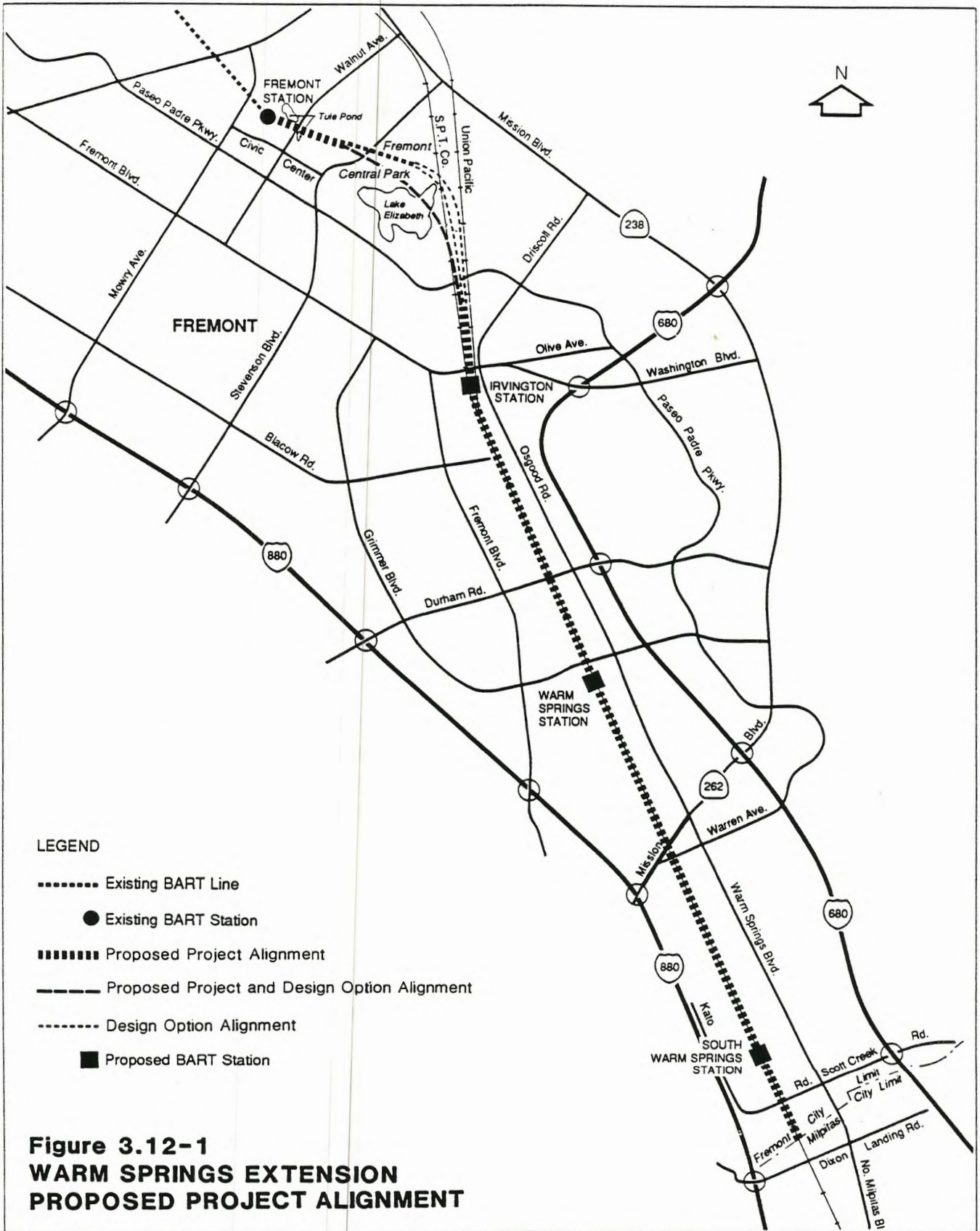
### 3.12.1 SETTING AND EXISTING CONDITIONS

The three proposed new BART stations are located in the southeastern portion of the City of Fremont (see Figure 3.12-1). Regional access is provided by the freeway system (Interstate Route 680 and Interstate Route 880) and State Routes 238 and 262 (Mission Boulevard).

---

<sup>1</sup> Details of calculations are provided in a separately bound technical appendix available for review through the BART's Extensions Planning Department.





SOURCE: DKS Associates, 1991

Not to Scale

### Regional Highway Access

Interstate 880 (I-880) runs north-south through the corridor, serving both Fremont and Milpitas. The interstate extends north of Fremont to Oakland and south of Milpitas to San Jose. From San Leandro to Mission Boulevard, I-880 is a six-lane facility; from Mission Boulevard to the Alameda/Santa Clara County line, I-880 is a four-lane facility. Interstate 880 runs at or near capacity during the peak hour. Near the Fremont Boulevard interchange, I-880's two-way peak hour traffic volume in 1989 was about 14,200 vehicles, and the average daily traffic (ADT) volume was about 130,000 vehicles.<sup>1</sup>

Interstate 680 (I-680) runs north-south through the corridor east of I-880. It serves Fremont and Milpitas, and extends northeast into eastern Alameda and Contra Costa Counties. The segment of I-680 in the project corridor is a six-lane facility. Near the Alameda/Santa Clara County line, the peak hour traffic volume on I-680 is 11,700 vehicles, and the ADT volume is about 98,000 vehicles. The capacity north of the county line is over 12,000 vehicles per hour.

State Route 262 (SR 262-Mission Boulevard) is a four-lane facility connecting I-680 to I-880 in southern Fremont. Traffic is highest near I-680 where Mission Boulevard becomes State Route 238 (SR 238), and extends north and west to Hayward. At this location, it has a peak hour traffic volume of about 5,300 vehicles and an average daily traffic volume of about 44,000 vehicles. It varies in width between 2 and 4 lanes. It has an ADT of about 31,800 vehicles just west of I-680.

### Transit Service

Transit service in the extension corridor is provided by BART, AC Transit, and Santa Clara County Transit. AC Transit provides primarily local service, with feeder service to the Fremont Station; the Santa Clara County Transit District (SCCTD) provides express bus feeder service to the Fremont Station and to Milpitas.

BART currently runs trains to and from the Fremont terminus and Richmond and Daly City. Existing daily ridership at the Fremont Station is about 10,000 patrons. The Daly City service does not run evenings and Sundays, but travellers may transfer to the Daly City - Concord Line

---

<sup>1</sup> All traffic counts on state highways are two-way and were obtained from *1989 Traffic Volumes on State Highways*, Caltrans, 1990.

at one of the downtown Oakland stations. Weekday headways are 15 minutes on the Daly City and Richmond lines, 20 minutes during the day on Saturday, on week nights and on Sundays.

### Adequacy of Roadway Network

Capacity constraints on urban roadway networks usually occur at intersections. Therefore, traffic impact analyses and determination of roadway network adequacy are usually focused on the volume of traffic compared to the capacity of the intersections. The standard way for traffic engineers to determine the levels of congestion at an intersection during peak travel periods is a concept called level of service (LOS). Level of service grades will be used throughout the discussion of traffic setting and impacts. Different techniques are used to calculate LOS for different types of intersections.

There are three types of intersection control in the study area:

- **Signalized intersections** in this report were evaluated using the *Circular 212* method of intersection capacity analysis modified as used by the City of Fremont.<sup>1</sup> This method of intersection capacity analysis uses letter grades A through F to indicate the level of congestion and delay at a given intersection. There are six level of service grades (A through F). A level of service of "A" (LOS A) indicates free flow traffic conditions with insignificant levels of delay. LOS C is stable operation, with acceptable delay, and LOS F represents forced flow, gridlocked conditions. The LOS is determined from the calculation of a volume-to-capacity (V/C) ratio of the intersection. Table 3.12-1 shows the definition and V/C ratio boundaries for each of the LOS letter grades.
- **Unsignalized intersections** (stop-controlled intersections) are also graded by letters, but the meaning is somewhat different. The grades for unsignalized intersections represent the amount of reserve capacity available on individual turning movements that conflict with other turning movements. A poor level of service grade at an unsignalized intersection is usually less onerous than at a signalized intersection, since only one or two movements are affected, rather than the entire intersection. Table 3.12-2 shows the level of service definitions for unsignalized intersections.

---

<sup>1</sup> Transportation Research Board, *Interim Materials on Highway Capacity, Transportation Research Circular 212*, January 1980.

**Table 3.12-1  
Level of Service Definitions  
Signalized Intersections**

| Level of Service | Volume to Capacity Ratio (V/C) | Description                                                                                                                                                                             |
|------------------|--------------------------------|-----------------------------------------------------------------------------------------------------------------------------------------------------------------------------------------|
| A                | 0.00-0.60                      | <b>Free Flow/Insignificant Delays:</b> No approach phase is fully utilized by traffic and no vehicle waits longer than one red indication.                                              |
| B                | 0.61-0.70                      | <b>Stable Operation/Minimal Delays:</b> An occasional approach phase is fully utilized. Many drivers begin to feel somewhat restricted within platoons of vehicles.                     |
| C                | 0.71-0.80                      | <b>Stable Operation/Acceptable Delays:</b> Major approach phases fully utilized. Most drivers feel somewhat restricted.                                                                 |
| D                | 0.81-0.90                      | <b>Approaching Unstable/Tolerable Delays:</b> Drivers may have to wait through more than one red signal indication. Queues may develop but dissipate rapidly, without excessive delays. |
| E                | 0.91-1.00                      | <b>Unstable Operation/Significant Delays:</b> Volumes at or near capacity. Vehicles may wait through several signal cycles. Long queues form upstream from intersection.                |
| F                | N/A                            | <b>Forced Flow/Excessive Delays:</b> Represents jammed conditions. Intersection operates below capacity with low volumes. Queues may block upstream intersections.                      |

Source: Transportation Research Board, *Interim Materials on Highway Capacity*, Transportation Research Circular 212, 1980.

- **All-way stop-controlled intersections** are distinguished by the *Highway Capacity Manual* as only "better than LOS C" or "worse than LOS C". Table 3.12-3 provides a definition of LOS at all-way stop-controlled intersections.

In the City of Fremont, development project sponsors are generally required to mitigate impacts to a mid-LOS D level, or a volume/capacity (V/C) ratio of 0.85. Throughout this section there are numerous references to City of Fremont plans to widen or improve roadways and intersections.

**Table 3.12-2**  
**Level of Service Definitions**  
**Unsignalized Intersections**

| Level of Service | Expected Delay                                                                      | Reserve Capacity<br>(Vehicles/Hour) |
|------------------|-------------------------------------------------------------------------------------|-------------------------------------|
| A                | Little or no delay                                                                  | $\geq 400$                          |
| B                | Short traffic delay                                                                 | 300-399                             |
| C                | Average traffic delays                                                              | 200-299                             |
| D                | Long traffic delays                                                                 | 100-199                             |
| E                | Very long traffic delays                                                            | 0-99                                |
| F                | Extreme delays potentially affecting<br>other traffic movements in the intersection | $\leq 0$                            |

Source: *Highway Capacity Manual*, Special Report 209, Transportation Research Board Washington, D.C., 1985.

**Table 3.12-3**  
**Level of Service at All-Way Stop-Controlled Intersections**

| Demand<br>Split | Level of Service (LOS) C Volume, VPH<br>---- Number of Lanes ---- |        |        |
|-----------------|-------------------------------------------------------------------|--------|--------|
|                 | 2 by 2                                                            | 2 by 4 | 4 by 4 |
|                 | 50/50                                                             | 1,200  | 1,800  |
| 55/45           | 1,140                                                             | 1,720  | 2,070  |
| 60/40           | 1,080                                                             | 1,660  | 1,970  |
| 65/35           | 1,010                                                             | 1,630  | 1,880  |
| 70/30           | 960                                                               | 1,610  | 1,820  |

Source: Transportation Research Board, *Highway Capacity Manual*, 1985.

For the most part, these improvements are to be funded by the development community through impact fees, or provision of frontage improvements as a condition of approval. Improvement assumptions are taken from the study of traffic impact fees done for the City of Fremont in March 1991.<sup>1</sup> The improvement needs are based on buildout of the City of Fremont General Plan, May 1991. The fee plan has not yet been approved by the City Council. Since the funding of these projects is dependent on development, their timing is uncertain. By the same token, if development does not occur, the need for improvements will be less.

### **Irvington Station Area**

**Roadway Network and Existing Traffic Volumes.** The proposed Irvington Station would be located near the southwest corner of the intersection of Washington Boulevard and Driscoll Road/Osgood Road (see Figure 3.12-2). Access from I-680 would enter/exit at the Washington Boulevard interchange to the east of the proposed station. Traffic from I-880 would use interchanges at either Stevenson Boulevard, Durham Road, or Fremont Boulevard.

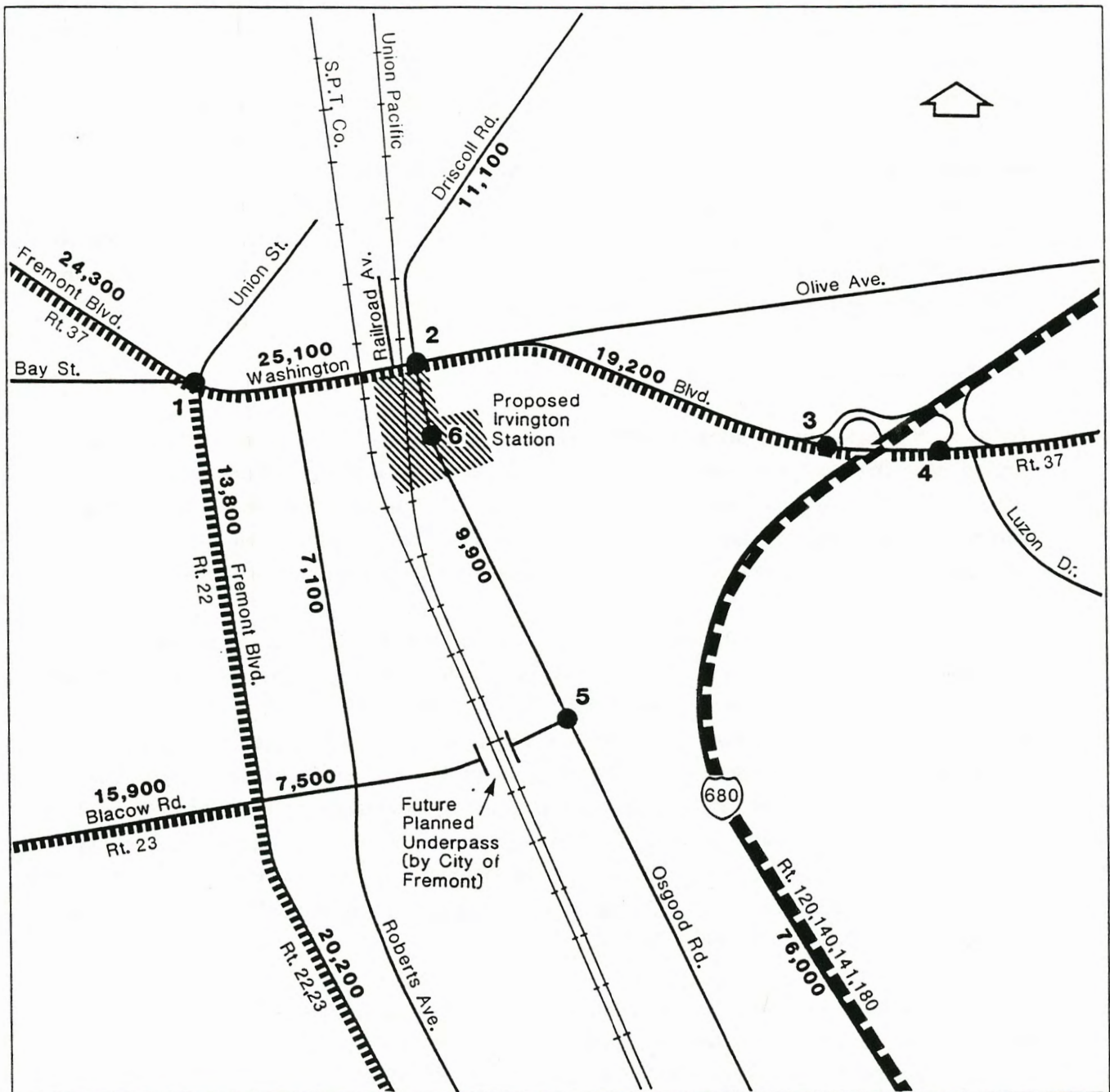
Direct vehicular access to the station and parking lots is via Osgood Road, as shown in Figure 2-4. There are several travel routes to access the station and parking lots on Osgood Road. Local traffic from the west would use Blacow Road and Fremont Boulevard. Blacow Road is a four-lane divided road that terminates just west of the SPTCo tracks. It had an ADT volume of about 15,900 vehicles in 1989 on the section between Fremont Boulevard and Grimmer Boulevard.<sup>2</sup> The City of Fremont has plans to extend the road under the tracks to connect with Osgood Road. Fremont Boulevard, south of Washington Boulevard narrows to a two-lane undivided roadway that is planned to be widened to four lanes between Blacow Road and Washington Boulevard. The ADT on Fremont Boulevard was about 13,800 vehicles south of Washington Boulevard in 1989.

Travellers from the north to the proposed station may also use Fremont Boulevard. Fremont Boulevard, north of Washington Boulevard, is a four-lane facility with an ADT of 24,300 vehicles. Driscoll Road, a four-lane divided facility with an ADT of 11,100 vehicles, also would provide access to and from the north.





---

<sup>1</sup> City of Fremont, *Traffic Impact Fees, Final Report*, prepared by DKS Associates, March, 1991.

<sup>2</sup> All ADT values are from the *City of Fremont 1989 Traffic Flow Map*.



**Figure 3.12-2**  
**EXISTING TRANSPORTATION**  
**SERVICE**  
**Irvington Station Vicinity**

-  Rt. 22 AC Transit Bus Route
-  Rt. 120 Santa Clara County Transit Bus Route
-  000 Two Directional Average Daily Traffic 1989
-  ● Intersections Evaluated in Traffic Analysis

Source: DKS Associates, 1991  
 AC Transit  
 City of Fremont

### 3.12 Transportation

Osgood Road and Fremont Boulevard serve traffic from the south. Osgood Road is a two-lane undivided facility that is planned to be widened to four lanes by the City. It has an ADT of about 9,900 vehicles just south of Washington Boulevard. Roberts Avenue, a residential street with discontinuous sidewalks provides access from the south. The road is located just west of the proposed alignment that extends from north of Washington Boulevard on the north to south of Blacow Road on the south. Roberts Avenue has an ADT of about 7,100 vehicles.

Washington Boulevard would serve traffic from the east. On the north side of the station site, it is a four-lane undivided road that crosses the SPTCo and UPRR tracks. East of Olive Avenue, it becomes a two-lane road. Between the I-680 Interchange and Paseo Padre Parkway it becomes a four-lane road. The City of Fremont plans call for the street to be widened to four lanes from Fremont Boulevard to Mission Boulevard. The ADT on Washington Boulevard is about 25,100 vehicles just west of the proposed station site.

After consultation with City of Fremont Public Works Department staff, six intersections were identified for evaluation in the Irvington Station area:

1. Fremont Boulevard/Bay Street - Washington Boulevard/Union Street
2. Driscoll Road - Osgood Road/Washington Boulevard
3. I-680 Southbound Ramps/Washington Boulevard
4. I-680 Northbound Ramps/Washington Boulevard
5. Osgood Road/Blacow Road (Impact Analysis Only)<sup>1</sup>
6. Osgood Road/Proposed Irvington Station Access Road (Impact Analysis Only)

**Traffic Conditions.** The Osgood Road/Blacow Road intersection currently has a negligible amount of traffic since Blacow Road ends at the railroad tracks to the east. The City of Fremont has plans to connect Blacow Road between Roberts Avenue and Osgood Road. After the connection is built, the traffic at the intersection is expected to increase.

The existing turning movement volumes for the intersections listed above are shown in Figure 3.12-3.<sup>2</sup> These volumes are used in calculating the existing A.M. and P.M. peak hour

---

<sup>1</sup> "Impact Analysis Only" means that the intersection is evaluated during the impact analysis and not under existing conditions, because it either does not currently exist or has negligible amounts of traffic.

<sup>2</sup> Turning movements are from traffic counts conducted between 1988 and 1990.



### 3.12 Transportation

levels of service at the intersections shown in Table 3.12-4.<sup>1</sup> Recent improvements at the intersection of Fremont Boulevard/Washington Boulevard/Union Street/Bay Street now ensure that all signalized intersections in the vicinity of the proposed Irvington Station operate at LOS D or better. At the unsignalized intersection of the I-680 southbound ramps with Washington Boulevard, the I-680 southbound off-ramp right turn movement operates at LOS E during the evening peak hour.

**Table 3.12-4**  
**Existing<sup>1</sup> Intersection Volume/Capacity<sup>2</sup> (V/C) Ratios and Level of Service<sup>3</sup>**  
**A.M. and P.M. Peak Hour**  
**Irvington Station Vicinity**

|                                                                        | A.M.   | P.M.   |
|------------------------------------------------------------------------|--------|--------|
| 1. Fremont Blvd/Bay Street - Washington Blvd/Union Street <sup>4</sup> | 0.62 B | 0.66 B |
| 2. Driscoll Rd/Osgood Rd/Washington Blvd.                              | 0.83 D | 0.78 C |
| 3. I-680 SB Ramps/Washington Blvd.                                     | D/A    | E/B    |
| 4. I-680 NB Ramps/Washington Blvd.                                     | 0.45 A | 0.49 A |
| 5. Osgood Road/Blacow Road <sup>5</sup>                                | --     | --     |
| 6. Osgood Road/Proposed Irvington Station <sup>6</sup>                 | --     | --     |

<sup>1</sup>Existing conditions are based on traffic counts between 1988 and 1990.

<sup>2</sup>Unsignalized intersections do not have V/C ratios. Letter codes indicate worst movement from the minor street followed by worst movement from major street.

<sup>3</sup>Does not reflect effect of freight train movements across Washington Boulevard.

<sup>4</sup>Reflects recent improvements at this intersection.

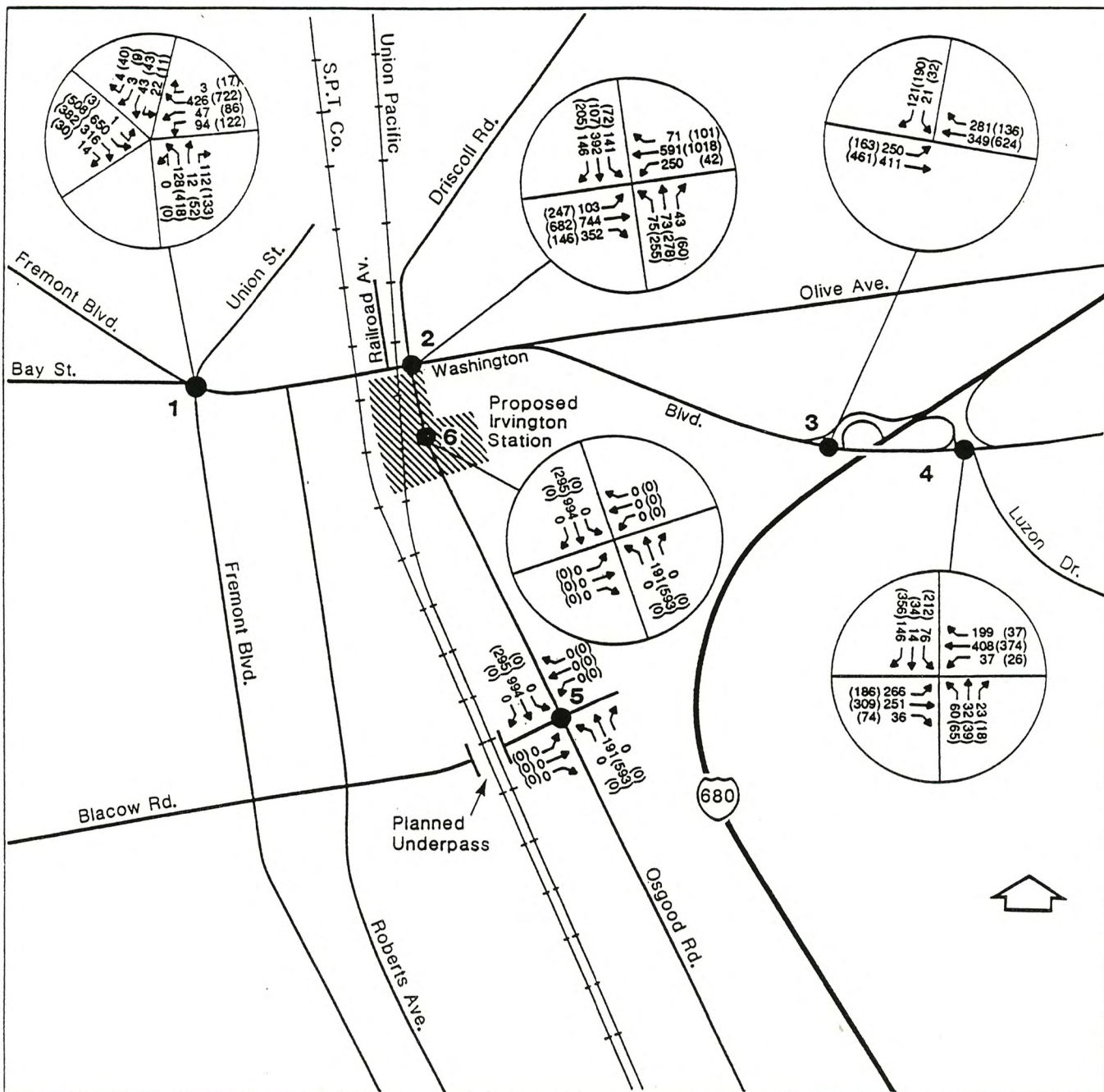
<sup>5</sup>Not a major intersection under existing conditions.

<sup>6</sup>Does not currently exist.

Source: City of Fremont, 1988-1990.

**Parking Conditions.** Parking is not allowed on Washington Boulevard in the vicinity of the proposed station. Parking on the southbound side of Osgood Road near the proposed station would be eliminated once the station is built. The Irvington Plaza shopping center located near Washington Boulevard/Fremont Boulevard has a parking lot which is relatively empty in the morning but almost full in the evenings.

<sup>1</sup> Details of all level of service calculations are included in a separately bound technical appendix, available for review through BART's Extension Planning Department.



**Figure 3.12-3**  
**PEAK HOUR TURN VOLUMES**  
**Existing Conditions (Years 1988-1990)**  
**Irvington Station Vicinity**

00 AM Peak Hour  
 (00) PM Peak Hour  
 ● Intersections Evaluated in Traffic Analysis

Source: DKS Associates, 1991

**Bike Lanes.** Bikes can legally use all roads that serve the proposed station area. There are no bike lanes on Washington Boulevard and Osgood Road in the immediate vicinity of the station. However, on Washington Boulevard, east of the intersection with Olive Avenue the road becomes wide enough for bicycles, but there is no striped bike lane. Bicycle travel on Washington Boulevard from the west requires crossing of the SPTCo and UPRR tracks. The conditions of track crossings on Washington Boulevard are adequate for bicycle crossing. Roberts Avenue also could be used for bicycle travel from the south.

**Pedestrian Circulation.** There are sidewalks on all streets for pedestrian travel to the proposed station with the following exceptions:

- Osgood Road
- Driscoll Road
- Roberts Avenue (sidewalks are discontinuous)

**Rail Lines.** Currently, the freight rail lines intersect Washington Boulevard currently. The rail crossings are equipped with crossing signals with automatic gates. About 16 train movements per day are experienced across Washington Boulevard. These movements cause significant disruption of auto movement on Washington Boulevard, Driscoll Road and Osgood Road.

**Transit Service.** AC Transit routes 37 and 22 serve the area close to the proposed station site. Route 37 provides service between Newark at Newark/Hesperian Boulevards and Ohlone College and runs along Fremont Boulevard and Washington Boulevard in the vicinity of the proposed station site. It operates every 30 minutes from 7:00 A.M. till 10:00 P.M., Monday through Friday only. Route 22 provides service between northern Milpitas and the Fremont Station and runs along Fremont Boulevard in the vicinity of the proposed station site. It also operates every 30 minutes from 5:00 A.M. to 9:00 P.M. Monday to Friday and from 9:00 A.M. to 6:00 P.M. on the weekends and holidays. As shown in Figure 3.12-2, no Santa Clara County Transit District (SCCTD) routes serve the proposed station site.

### Warm Springs Station Area

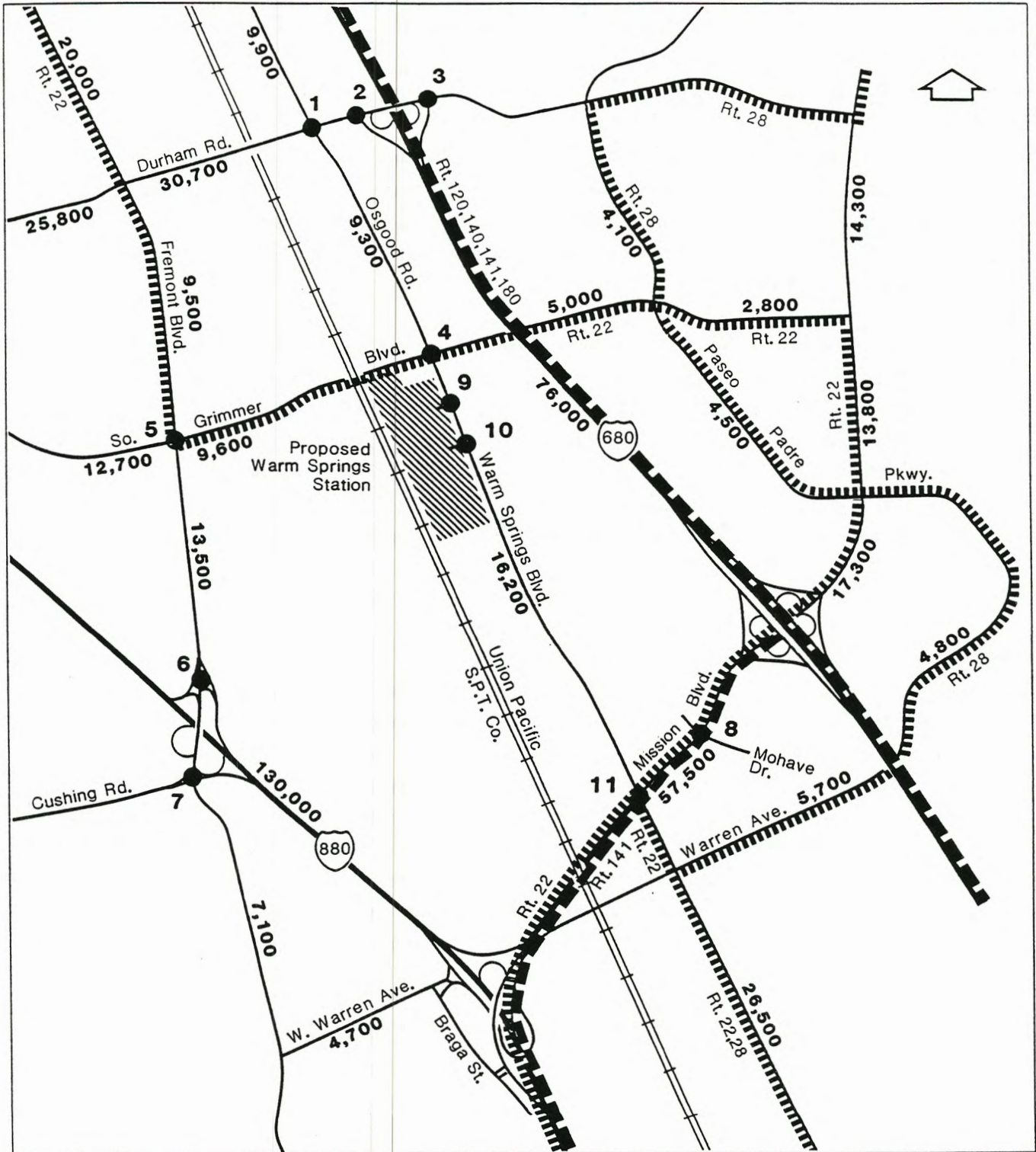
**Roadway Network and Existing Traffic Volumes.** The proposed Warm Springs Station would be located south of the intersection of South Grimmer Boulevard and Warm Springs Boulevard (See Figure 3.12-4). The direct vehicular access into the proposed station site and parking lot would be via Warm Springs Boulevard as shown in Figure 2-5. There are several travel routes to access Warm Springs Boulevard.

Regional access from I-880 would be via the Fremont Boulevard interchange to Grimmer Boulevard. Fremont Boulevard is a four-lane divided road between I-880 and Grimmer Boulevard. Grimmer Boulevard also is a four-lane divided road west of Warm Springs Boulevard, and two lanes undivided east of Warm Springs Boulevard (called South Grimmer Boulevard). The City of Fremont has plans to widen South Grimmer Boulevard to four lanes between Warm Springs Boulevard to just east of I-680. Some I-880 traffic might use the Mission Boulevard (SR 262) interchange and Warm Springs Boulevard to access the station site. Mission Boulevard is a four-lane divided facility that serves as a major thoroughfare, as well as a connector between I-880 and I-680. It is heavily congested during the peak periods, and has an ADT of about 57,500 vehicles.





Access from I-680 would be via either the Durham Road interchange to Osgood Road and Warm Springs Boulevard or via the Mission Boulevard interchange to Warm Springs Boulevard. Durham Road is a four-lane divided road between I-680 and Osgood Road, with an ADT of about 30,700 vehicles. Osgood Road is a four-lane road with a continuous center left-turn lane between Durham Road and South Grimmer Boulevard, with an ADT of about 9,300 vehicles. The road name changes to Warm Springs Boulevard south of South Grimmer Boulevard, where it becomes a two-lane rural road. City of Fremont plans provide for Osgood Road/Warm Springs Boulevard to become a four-lane undivided facility from Washington Boulevard to just north of Mission Boulevard. This widening would be the responsibility of approved adjacent developments.

Some passengers from I-680 might travel east on Mission Boulevard to Paseo Padre Parkway, and then to Grimmer Boulevard to access the station. Paseo Padre Parkway is a two-lane winding residential collector between Grimmer and Mission Boulevards with an ADT of about 4,500 vehicles.

After consultation with City of Fremont Public Works Department staff, the following key intersections in the Warm Springs station area were identified for study:



**Figure 3.12-4  
EXISTING TRANSPORTATION  
SERVICE  
Warm Springs Station Vicinity**

-  Rt. 22 AC Transit Bus Route
-  Rt. 120 Santa Clara County Transit Bus Route
-  000 Two Directional Average Daily Traffic 1989
-  ● Intersections Evaluated in Traffic Analysis

Source: DKS Associates, 1991  
AC Transit  
City of Fremont

1. Osgood Road/Durham Road
2. I-680 Southbound Ramps/Durham Road
3. I-680 Northbound Ramps/Durham Road
4. Warm Springs Boulevard-Osgood Road/South Grimmer Boulevard
5. Fremont Boulevard/South Grimmer Boulevard
6. Fremont Boulevard/I-880 Northbound Ramps
7. Fremont Boulevard/Cushing Road-I-880 Southbound Ramps
8. Mohave Drive/Mission Boulevard
9. Warm Springs Boulevard/Warm Springs Station (North Driveway) (Impact Analysis Only)
10. Warm Springs Boulevard/Proposed Warm Springs Station (South Driveway) (Impact Analysis Only)
11. Warm Springs Boulevard/Mission Boulevard

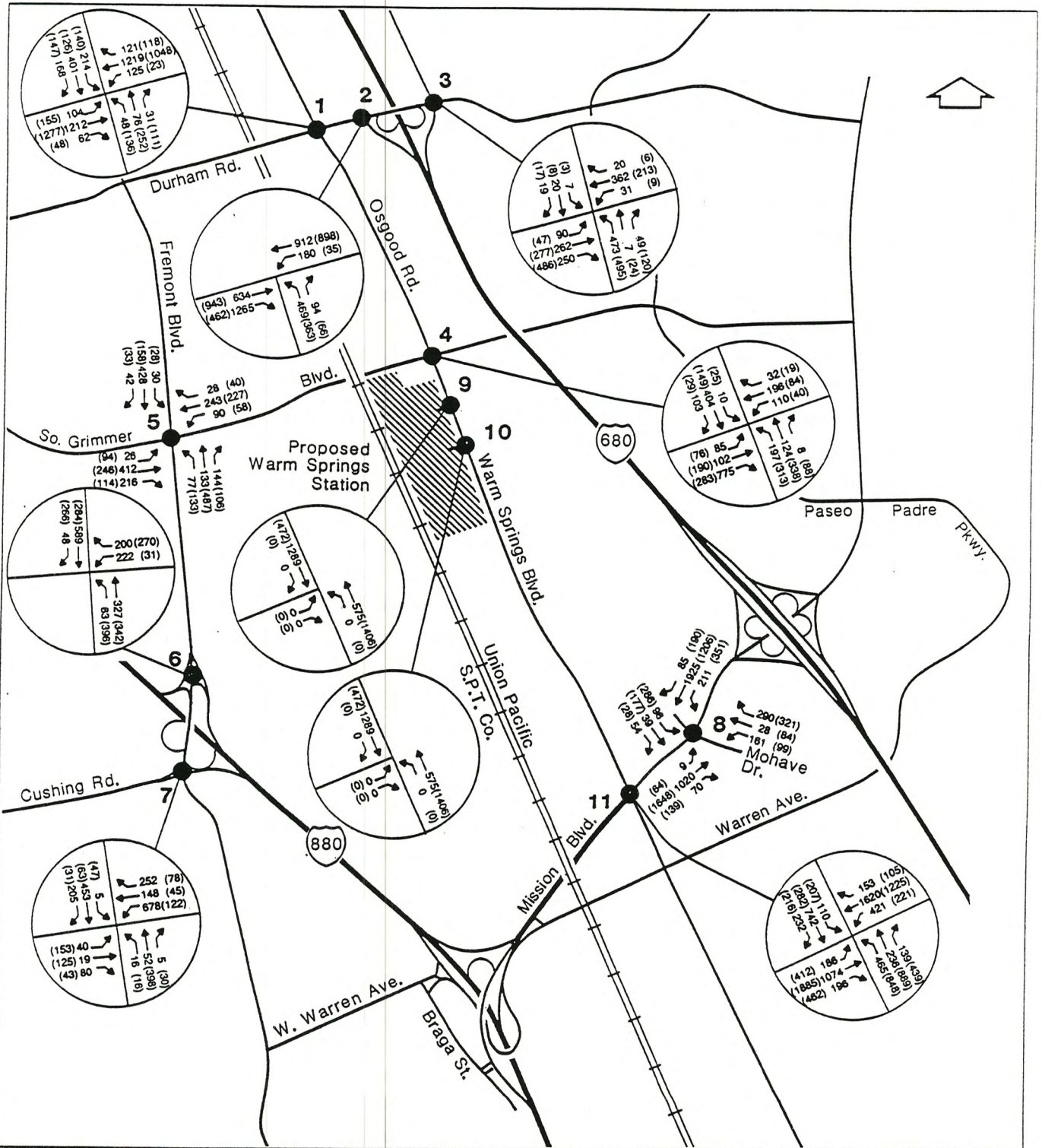
**Traffic Conditions.** The existing intersection turning movement volumes in the vicinity of the proposed station site are shown on Figure 3.12-5. The volumes are used in calculating the existing A.M. and P.M. peak hour LOS and are shown in Table 3.12-5. Service levels are all mid-D or better, except at the Mission/Mohave intersection which operates at mid-E.

**Parking Conditions.** Parking is not allowed on either side of South Grimmer Boulevard. There is, however, no apparent demand for on-street parking in the area, as the development near the proposed station provides its own off-street parking.

**Bike Lanes.** The shoulder of South Grimmer Boulevard near the vicinity of the proposed station is paved and has a striped bike lane. Warm Springs Boulevard does not have paved shoulders and bicyclists must use driving lanes. Osgood Road has paved shoulders for cycling.

**Pedestrian Circulation.** There are currently no sidewalks along the frontage of the proposed Warm Springs Station, since there is little residential in the immediate vicinity. Warm Springs Boulevard has unpaved shoulders for walking. Osgood Road, north of Grimmer Boulevard, has sidewalks for pedestrians. The City requires sidewalks be provided as part of roadway widening or improvement projects along with adjacent development.

**Rail Lines.** The freight rail lines are grade separated at South Grimmer Boulevard and Mission Boulevard.



**Figure 3.12-5**  
**PEAK HOUR TURN VOLUMES**  
**Existing Conditions (Years 1988-1990)**  
**Warm Springs Station Vicinity**

- 00 AM Peak Hour
- (00) PM Peak Hour
- Intersections Evaluated in Traffic Analysis

Source: DKS Associates, 1991

**Table 3.12-5**  
**Existing<sup>1</sup> Intersection Volume/Capacity<sup>2</sup> (V/C) Ratios and Level of Service**  
**A.M. and P.M. Peak Hour**  
**Warm Springs Station Vicinity**

|                                                                                      | A.M.   | P.M.   |
|--------------------------------------------------------------------------------------|--------|--------|
| 1. Osgood Rd/Durham Rd.                                                              | 0.74 C | 0.77 C |
| 2. I-680 SB Ramps/Durham Rd                                                          | 0.55 A | 0.51 A |
| 3. I-680 NB Ramps/Durham Rd                                                          | 0.44 A | 0.36 A |
| 4. Warm Spring Blvd/Osgood Rd/S. Grimmer Blvd                                        | >C     | >C     |
| 5. Fremont Blvd/S. Grimmer Blvd                                                      | 0.42 A | 0.38 A |
| 6. Fremont Blvd/I-880 NB Ramp                                                        | F/A    | D/A    |
| 7. Fremont Blvd/Cushing Rd/I-880 SB Ramp                                             | >C     | >C     |
| 8. Mohave Drive/Mission Blvd                                                         | 0.67 B | 0.95 E |
| 9. Warm Springs Blvd/Proposed Warm Springs Station<br>(North Driveway) <sup>3</sup>  | --     | --     |
| 10. Warm Springs Blvd/Proposed Warm Springs Station<br>(South Driveway) <sup>3</sup> | --     | --     |
| 11. Warm Springs Blvd/Mission Blvd                                                   | 0.82 D | 0.85 D |

<sup>1</sup>Existing conditions are based on traffic counts between 1988 and 1990.

<sup>2</sup>Unsignalized one- or two-way stop intersections do not have V/C ratios. Letter codes represent worst movement for the minor street followed by worst movement from major street. Four-way stop intersections are evaluated in a more general manner, with the level of service shown as either "better than C", shown as <C or "worse than C", shown as >C.

<sup>3</sup>Does not currently exist.

Source: City of Fremont, 1988-1990.

**Transit Service.** AC Transit Route 22 serves the area close to the proposed station. Route 22 provides service between northern Milpitas and the Fremont Station and runs along Fremont Boulevard and turns onto South Grimmer Boulevard in the vicinity of the proposed station site. It operates every 30 minutes from 6:00 A.M. to 8:00 P.M. Monday to Friday and from 9:00 A.M. to 5:00 P.M. on the weekends and holidays. As shown in Figure 3.12-3, AC Transit Route 28 and the SCDTD Routes 120, 140, 141 and 180 do not currently provide service along Warm Springs Boulevard in the vicinity of the proposed station site.



### **South Warm Springs Station**

**Roadway Network and Existing Traffic Volumes.** The proposed South Warm Springs Station would be located on the northwest corner of the intersection of Warm Springs Boulevard and Kato/Scott Creek Road (see Figure 3.12-6). The direct access into the proposed station site and parking lot would be from Warm Springs Boulevard and Kato Road, as shown in Figure 2-6. There are several travel routes to access Warm Springs Boulevard and Kato Road.

Regional access from I-880 would enter/exit at the Dixon Landing Road/I-880 ramps to the southwest of the proposed station. Regional access from I-680 would enter/exit at the Scott Creek Road/I-680 ramps to the east of the proposed station.

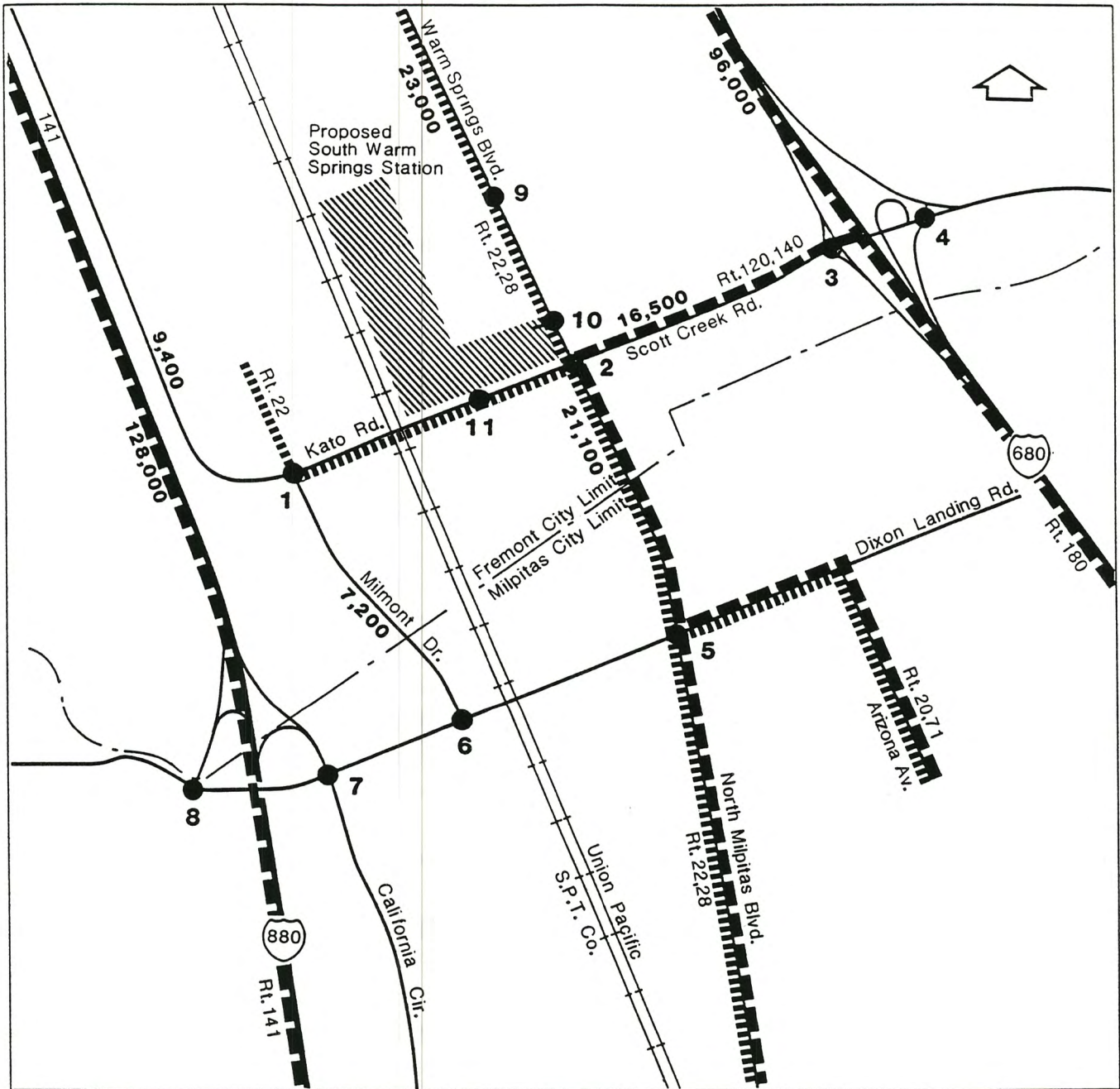
Local travel to and from the proposed station would be via Kato Road and Warm Springs Boulevard. Kato Road is a two-lane undivided facility which widens to four lanes west of the UPRR and SPTCo railroad tracks. Kato Road ADT was about 9,400 vehicles in 1989 west of Warm Springs Boulevard. Warm Springs Boulevard is a four-lane divided facility with an ADT of about 23,000 vehicles north of Kato Road.

Scott Creek Road is a four-lane undivided facility between Warm Springs Boulevard and I-680 that would serve traffic from the east. East of I-680, Scott Creek road narrows to a two-lane undivided residential collector that terminates within one mile east of I-680. Scott Creek Road has an ADT of about 16,500 vehicles west of Warm Spring Boulevard.

Warm Springs Boulevard, a four-lane divided facility, would serve traffic coming from the south and has an ADT of about 21,100 vehicles south of Scott Creek Road. The road becomes North Milpitas Boulevard between Scott Creek Road and Dixon Landing Road at the Fremont/Milpitas city limit.

Dixon Landing Road, which would provide access from the west, is a four-lane undivided facility between North Milpitas Boulevard and I-880 which narrows to a two-lane facility west of I-880. Dixon Landing Road terminates about one mile east of Warm Springs Road.

After consultation with City of Fremont Public Works Department staff, ten intersections were identified for analysis in the South Warm Springs Station area:



**Figure 3.12-6**  
**EXISTING TRANSPORTATION**  
**SERVICE**  
**South Warm Springs Station Vicinity**

- Rt. 22 AC Transit Bus Route
- Rt. 120 Santa Clara County Transit Bus Route
- 000 Two Directional Average Daily Traffic 1989
- Intersections Evaluated in Traffic Analysis

Source: DKS Associates, 1991  
 AC Transit  
 City of Fremont

### 3.12 Transportation

1. Milmont Drive/Kato Road
2. Warm Springs Boulevard/Kato Road - Scott Creek Road
3. I-680 SB Ramps/Scott Creek Road
4. I-680 NB Ramps/Scott Creek Road
5. North Milpitas Boulevard (Warm Springs Blvd)/Dixon Landing Road
6. Milmont Drive/Dixon Landing Road
7. I-880 NB Ramps/California Cr./Dixon Landing Road
8. I-880 SB Ramps/Dixon Landing Road
9. Warm Springs Boulevard/Proposed South Warm Springs Station entrance north (Impact Analysis Only)
10. Warm Springs Boulevard/Proposed South Warm Springs Station entrance south (Impact Analysis Only)
11. Proposed South Warm Springs Station entrance/Kato Road (Impact Analysis Only)

**Traffic Conditions.** Existing intersection turning movement volumes in the vicinity of the proposed station site are shown on Figure 3.12-7. The volumes are used in calculating the existing A.M. and P.M. peak hour levels of service as shown in Table 3.12-6. There are existing congestion problems at several locations in the immediate vicinity of the proposed South Warm Springs Station. For example, straight ahead movements on Kato Road are difficult since it is stop controlled and operates at LOS F. The signalized intersection of Warm Springs Boulevard/Kato Road/Scott Creek Road operates at LOS E in the P.M. peak hour.

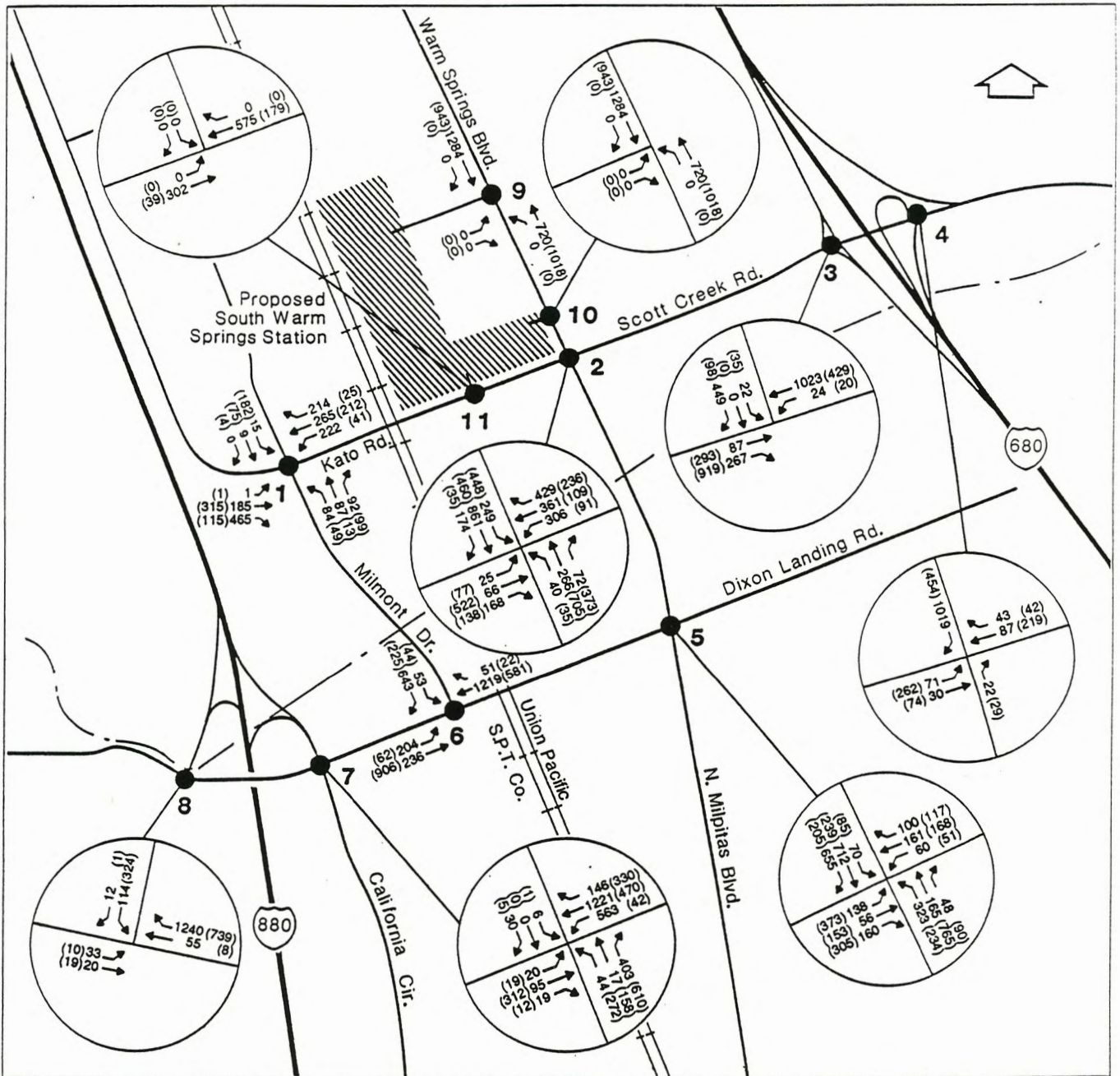
**Parking Conditions.** Parking is not allowed on streets near the proposed station.

**Bike Lanes.** There are bike lanes in each direction on Warm Springs Boulevard/North Milpitas Boulevard in the vicinity of the proposed station.

**Pedestrian Circulation.** There are no sidewalks in the vicinity of the proposed South Warm Springs Station area.

**Rail Lines.** The freight rail lines intersect Dixon Landing Road and Kato Road. The rail crossings are controlled by signals and barriers. About sixteen movements per day are typical at these crossings. There is considerable traffic delay when the trains cross.

**Transit Service.** AC Transit Routes 22 and 28 serve the area close to the proposed station. Routes 22 and 28 provide service between northern Milpitas and the Fremont Station. Route 22 runs along Warm Springs Boulevard from Mission Boulevard to south of Dixon Landing



**Figure 3.12-7**  
**PEAK HOUR TURN VOLUMES**  
**Existing Conditions (Years 1988-1990)**  
**South Warm Springs Station Vicinity**

- 00 AM Peak Hour
- (00) PM Peak Hour
- Intersections Evaluated in Traffic Analysis

Source: DKS Associates, 1991

**Table 3.12-6**  
**Current<sup>1</sup> Intersection Volume/Capacity<sup>2</sup> (V/C) Ratios and Level of Service<sup>3</sup>**  
**A.M. and P.M. Peak Hour**  
**South Warm Springs Station Vicinity**

| Intersection                                                 |      | A.M. |     | P.M. |     |
|--------------------------------------------------------------|------|------|-----|------|-----|
| 1. Milmont Dr/Kato Rd                                        |      |      | F/C |      | F/A |
| 2. Warm Springs Blvd/Kato Rd/Scott Creek Rd                  | 0.65 |      | B   | 0.97 | E   |
| 3. I-680 SB Ramps/Scott Creek Rd                             |      |      | D/A |      | C/A |
| 4. I-680 NB Ramps/Scott Creek Rd                             |      |      | A/A |      | A/A |
| 5. N. Milpitas Blvd - Warm Springs Blvd/<br>Dixon Landing Rd | 0.80 |      | C   | 0.66 | B   |
| 6. Milmont Dr/Dixon Landing Rd                               | 0.85 |      | D   | 0.44 | A   |
| 7. I-880 NB Ramps/Dixon Landing Rd                           | 0.96 |      | E   | 0.77 | C   |
| 8. I-880 SB Ramps/Dixon Landing Rd                           |      |      | A/A |      | A/A |
| 9. Warm Springs Blvd/Proposed Station (N) <sup>4</sup>       | --   | --   | --  | --   | --  |
| 10. Warm Springs Blvd/Proposed Station (S) <sup>4</sup>      | --   | --   | --  | --   | --  |
| 11. Kato Rd/Proposed Station <sup>4</sup>                    | --   | --   | --  | --   | --  |

1. Existing conditions are based on traffic counts between 1988 and 1990.

2. Unsignalized intersections do not have V/C ratios. Letter codes indicate worst movement from the minor street followed by worst movement from major street.

3. Does not reflect effects of trains on at-grade rail crossings.

4. Does not currently exist.

Source: City of Fremont, 1988-1990.

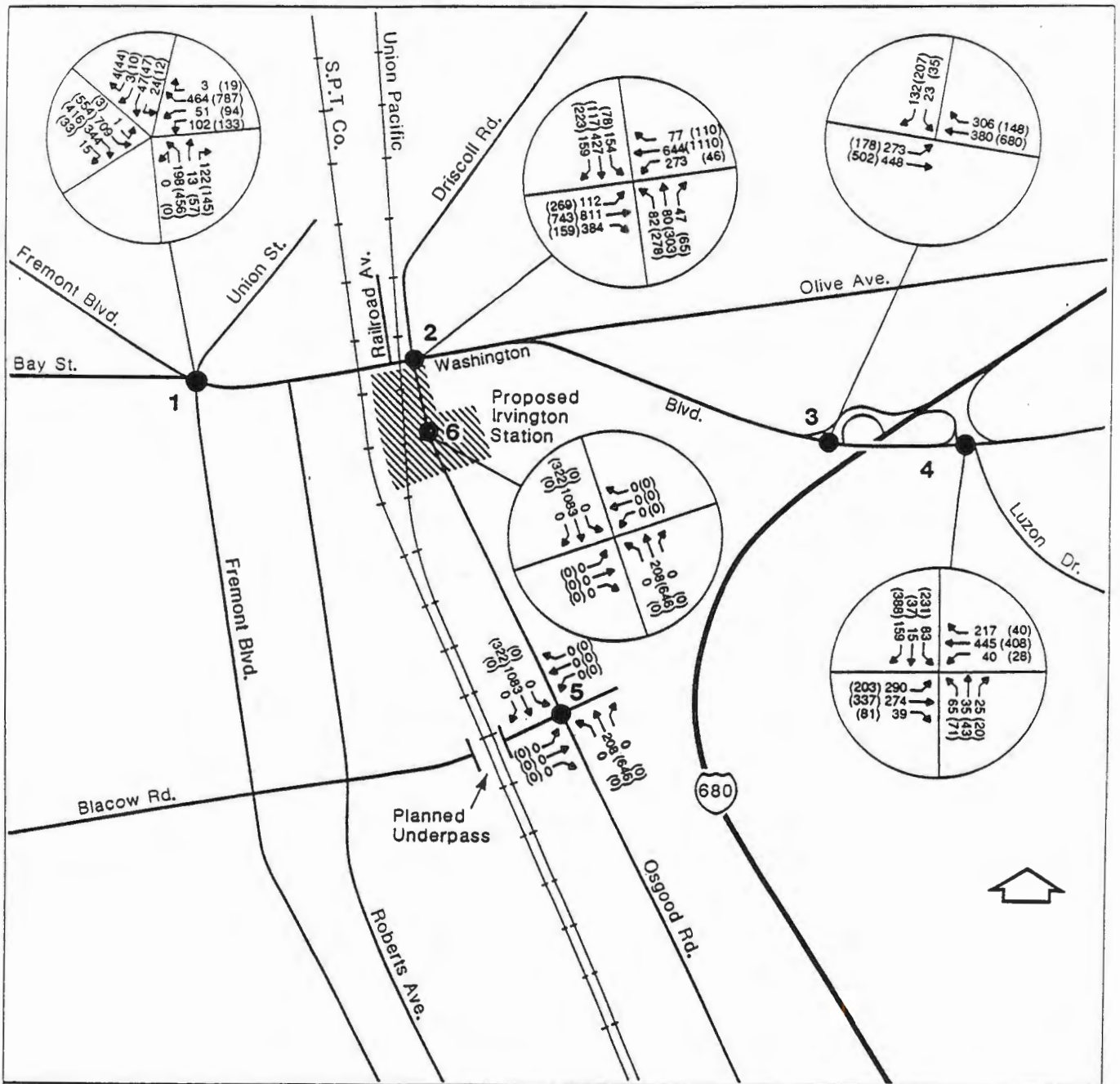
Road in Milpitas with a frequency of 30 minutes from 5:00 A.M. to 8:00 P.M. on weekdays. Route 22 also runs along Kato Road from Warren Avenue/I-880 to Warm Springs Boulevard. Route 28 runs along E. Warren Avenue and turns south onto Warm Springs Boulevard and terminates at the same location as Route 22 in Milpitas. Route 28 has 30 minute headways from 6:00 A.M. to 8:00 P.M. on weekdays.

SCCTD Routes 120 and 140 run along Warm Springs/North Milpitas Boulevard from Dixon Landing Road to Scott Creek/Kato Road in the vicinity of the proposed station site and provide service between the Fremont Station and Sunnyvale and Mountain View, respectively. Route 120 has 30 minute headways during the A.M. and P.M. peak periods. Route 140 has 60 minute headways in the A.M. peak period and 45 minute headways in the P.M. peak period.

**3.12.2 BACKGROUND ON STATION TRAFFIC IMPACT ANALYSIS**

**Methodology.** Evaluating the traffic impact of the proposed BART extension stations on regional and local auto access routes involved the following procedures:

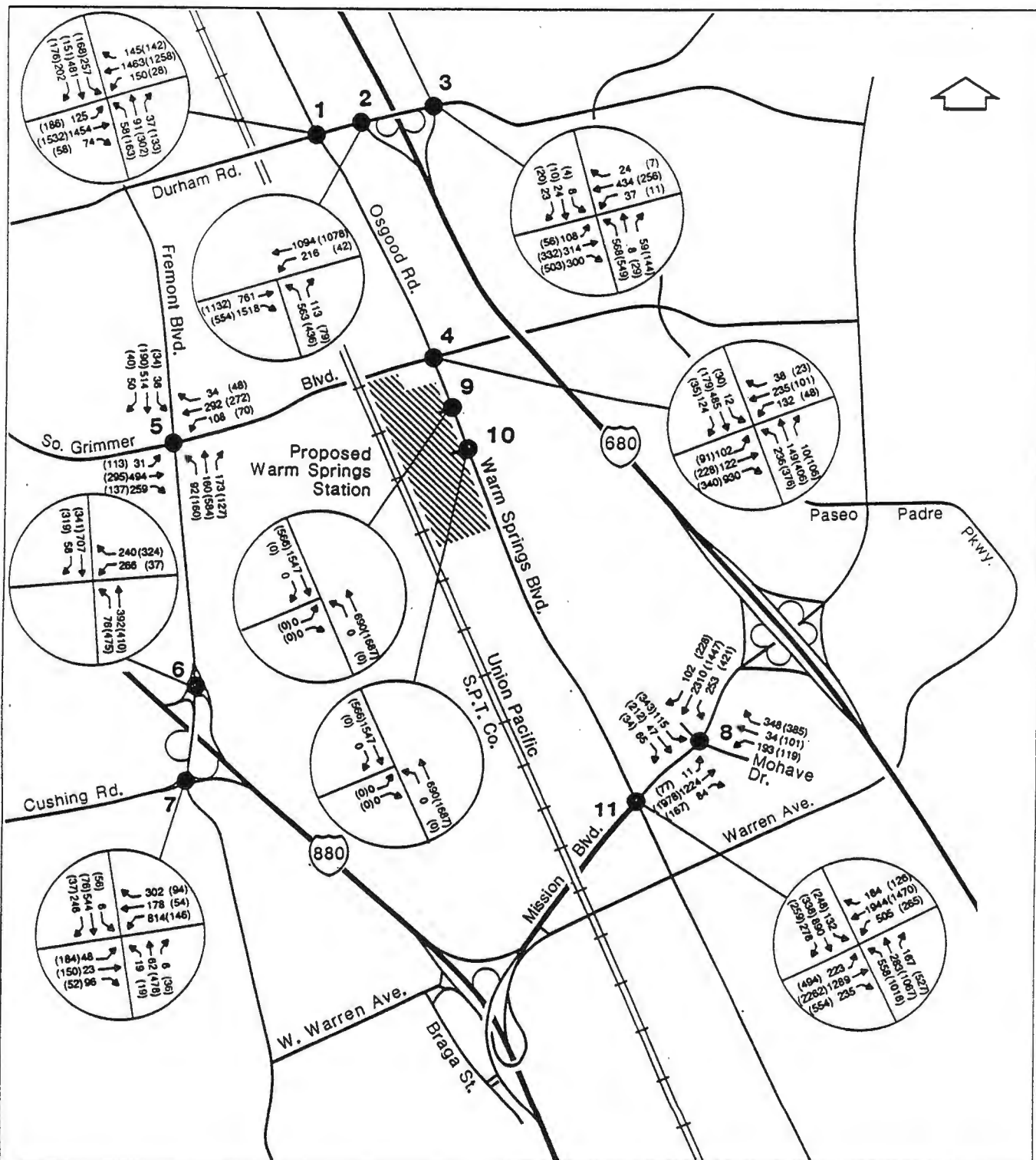
- Year 2010 traffic levels without a BART extension were estimated by using forecasts from the City of Fremont citywide traffic model. This model run assumed construction of all roadway improvements in the City of Fremont General Plan, May 1991, including the completion of Blacow Road between Roberts Avenue and Osgood Road, and a new freeway connection between I-880 and I-680.
- Traffic levels were estimated for year 1998 (assumed opening year of BART Warm Springs extension) without the BART extension. Based on consultation with the City of Fremont Public Works Department staff, growth rates for traffic volumes of intersections in the Irvington, Warm Springs and South Warm Springs station vicinity of 1 percent per year, 2 percent per year, and 2 percent per year, respectively, were applied to 1989 (base year) traffic volumes to project 1998 traffic levels without a BART extension. Figures 3.12-8, 3.12-9 and 3.12-10 show the 1998 base (without BART Warm Springs extension) turning movement volumes for each of the study intersections in the vicinity of the proposed stations.
- Morning and evening peak hour patronage was estimated by access mode at each of the proposed stations for existing conditions and years 1998 and 2010.
- Auto access patronage estimates were converted to A.M. and P.M. peak hour vehicle movements in and out of the proposed stations. This included accounting for kiss/ride trips that make one trip in and one trip out in each peak hour. Table 3.12-7 shows the estimated peak hour auto generation for each station for existing conditions and years 1998 and 2010.
- The distribution of auto access trips to and from the BART stations was estimated. The current MTC transit model and a recent license plate survey of the Fremont Station parking lot provided information on the origin of auto trips destined to each of the stations. Figures 3.12-11, 3.12-12 and 3.12-13 show trip distribution assumptions for the Irvington, Warm Springs and South Warm Springs stations, respectively for the Proposed Project and all build alternatives.



**Figure 3.12-8**  
**1998 PEAK HOUR TURN VOLUMES**  
**No BART Extension**  
**Irvington Station Vicinity**

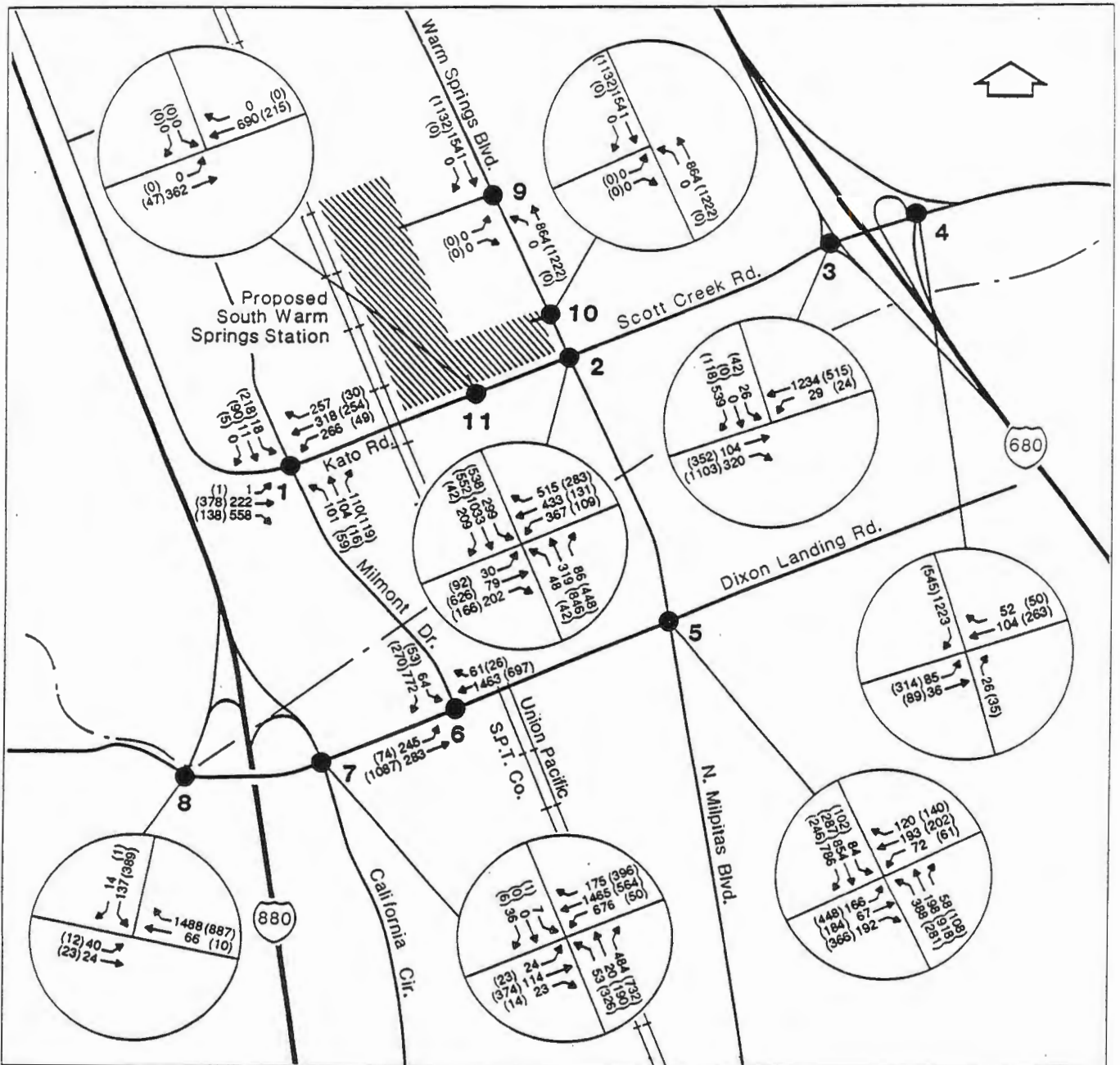
- 00 AM Peak Hour
- (00) PM Peak Hour
- Intersections Evaluated in Traffic Analysis

Source: DKS Associates, 1991



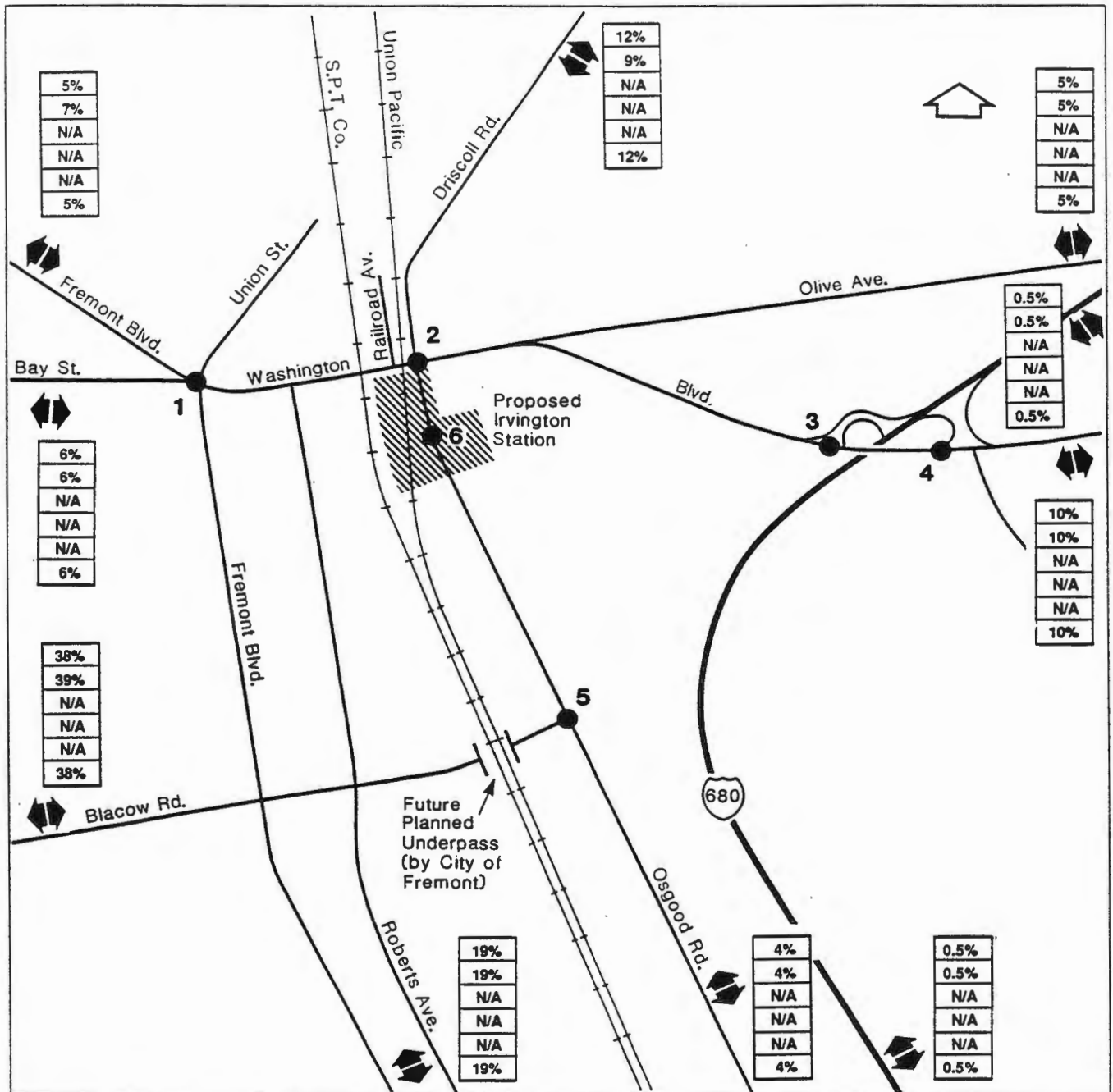
Source: DKS Associates, 1991





**Figure 3.12-10**  
**1998 PEAK HOUR TURN VOLUMES**  
**No BART Extension**  
**South Warm Springs Station Vicinity**

- 00 AM Peak Hour
- (00) PM Peak Hour
- Intersections Evaluated in Traffic Analysis

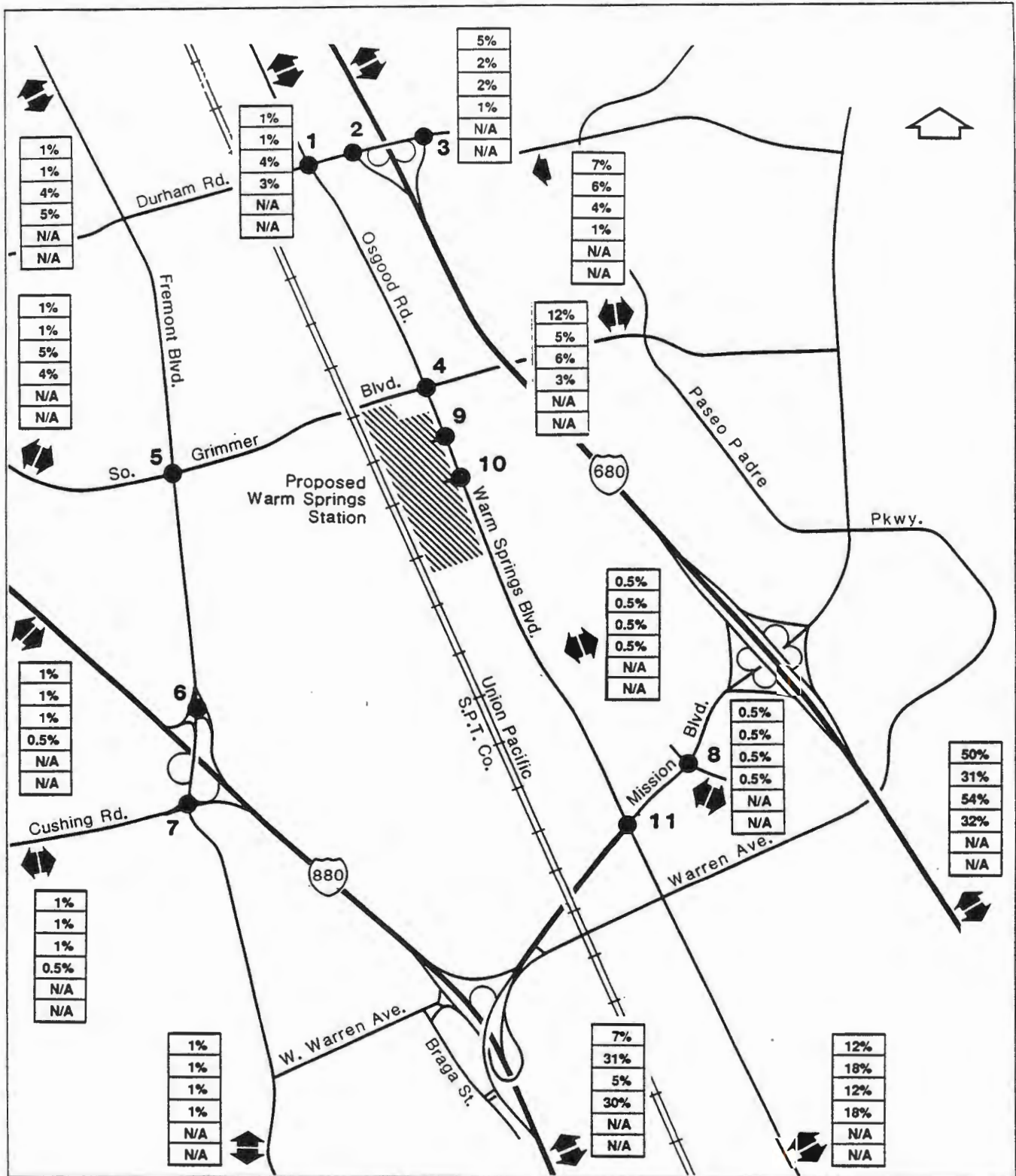


**Figure 3.12-11**  
**TRIP DISTRIBUTION**  
**Irvington Station Vicinity**  
**Proposed Project and**  
**Alternatives 4-11**

|     |
|-----|
| 00% |
| 00% |
| 00% |
| 00% |
| 00% |
| 00% |

- Gateway Distribution for Proposed Project
- Gateway Distribution for Alternatives 4 and 5
- Gateway Distribution for Alternatives 6, 7 and 8
- Gateway Distribution for Alternative 9
- Gateway Distribution for Alternative 10
- Gateway Distribution for Alternative 11

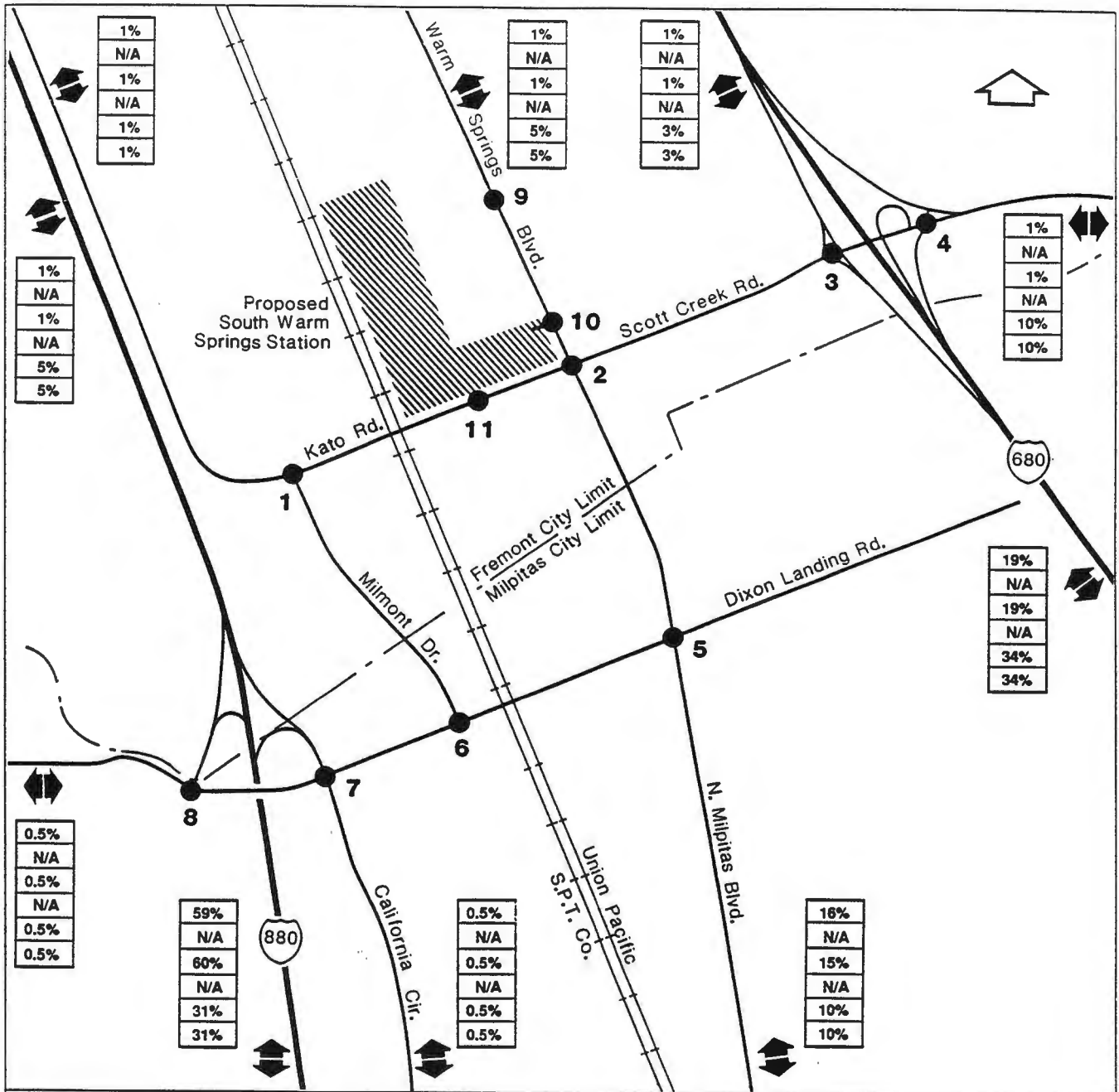
● Intersections Evaluated in Traffic Analysis



**Figure 3.12-12**  
**TRIP DISTRIBUTION**  
**Warm Springs Station Vicinity**  
**Proposed Project and**  
**Alternatives 4-11**

- 00% Gateway Distribution for Proposed Project
- 00% Gateway Distribution for Alternatives 4 and 5
- 00% Gateway Distribution for Alternatives 6, 7 and 8
- 00% Gateway Distribution for Alternative 9
- 00% Gateway Distribution for Alternative 10
- 00% Gateway Distribution for Alternative 11

● Intersections Evaluated in Traffic Analysis



**Figure 3.12-13**  
**TRIP DISTRIBUTION**  
**South Warm Springs Station Vicinity**  
**Proposed Project and**  
**Alternatives 4-11**

- 00% Gateway Distribution for Proposed Project
- 00% Gateway Distribution for Alternatives 4 and 5
- 00% Gateway Distribution for Alternatives 6, 7 and 8
- 00% Gateway Distribution for Alternative 9
- 00% Gateway Distribution for Alternative 10
- 00% Gateway Distribution for Alternative 11

● Intersections Evaluated in Traffic Analysis

**Table 3.12-7  
Estimated Peak Hour Auto Trip Generation  
New Station(s), Proposed Project**

|             | Irvington<br>---- Station ---- |            |            | Warm Springs<br>---- Station ---- |            |            | South Warm Springs<br>---- Station ---- |            |            |
|-------------|--------------------------------|------------|------------|-----------------------------------|------------|------------|-----------------------------------------|------------|------------|
|             | 1991                           | 1998       | 2010       | 1991                              | 1998       | 2010       | 1991                                    | 1998       | 2010       |
| AM Inbound  | 235                            | 256        | 288        | 393                               | 440        | 523        | 343                                     | 369        | 416        |
| AM Outbound | <u>62</u>                      | <u>67</u>  | <u>75</u>  | <u>103</u>                        | <u>116</u> | <u>138</u> | <u>90</u>                               | <u>97</u>  | <u>110</u> |
| AM TOTAL    | 297                            | 323        | 363        | 496                               | 556        | 661        | 433                                     | 466        | 526        |
| PM Inbound  | 89                             | 97         | 111        | 149                               | 167        | 199        | 130                                     | 140        | 158        |
| PM Outbound | <u>181</u>                     | <u>197</u> | <u>222</u> | <u>303</u>                        | <u>339</u> | <u>402</u> | <u>264</u>                              | <u>284</u> | <u>320</u> |
| PM TOTAL    | 270                            | 294        | 333        | 452                               | 506        | 601        | 394                                     | 424        | 478        |

Source: DKS Associates, 1991.

- Traffic to and from the proposed BART station was assigned to the street system for 1991, 1998 and 2010. This reflected the analyst's judgment regarding access paths between station and various directions. Factors taken into account in making these judgments included: location and service provided by BART station entrances and exits, a volume plot of station traffic from the City of Fremont traffic model, and anticipated congestion or opportunities for shortcuts evident from general knowledge of the station areas.
- Direct impacts of station traffic were determined by adding the estimated traffic generated by the BART extension to traffic volumes without the extension at year 1991 and 1998 levels.
- Cumulative impacts were determined in the same manner as direct project impacts, in the context of year 2010 base conditions (without a BART Warm Springs extension.)
- Intersection LOS analysis was performed for each affected intersection. Where appropriate, mitigation measures were developed.

**Roadway Assumptions.** The traffic impact analysis was conducted based on the following assumptions. In all but one location, it was assumed that roadways in 1998 would be the same as they are under existing conditions. The analysis does not include future roadway improvements such as roadway widenings or traffic signals. The analysis also does not include new roadways, such as the connection of Blacow Road between Roberts Avenue and Osgood Road and the I-880 and I-680 connectors. The only improvement project included involves Warm Springs Boulevard/Scott Creek-Kato Road, where planned improvements will be implemented before 1998; these improvements include the addition of a left-turn lane and a thru-lane on both the northbound and southbound approaches. An additional thru-lane and a shared right-turn lane are also planned for the eastbound approach.

For analysis of condition in the year 2010, roadway improvements were included. Most of the planned improvements were provided by City of Fremont Public Works Department staff. These improvements include roadway widenings, additional turning lanes, traffic signals and new roadways. A complete list of assumed roadway improvements in the Fremont area is provided in the Transportation Technical Report.

**Criterion.** Appendix G of the CEQA Guidelines states that a project has a significant traffic impact if it causes "an increase in traffic which is substantial in relation to the existing load and capacity of the street system." In this analysis, "LOS" is the measure of traffic impacts of a station. An identifier of the impact of an increase in traffic is often the calculation of the V/C ratio and determination of LOS. The City of Fremont's General Plan Policy T1.2.1 is to:

Maintain a level of service D, with a target volume-to-capacity ratio of 0.85 at major intersections, except where the achievement of such a level of service can be demonstrated to conflict with environmental, historic or aesthetic objectives or where regional traffic is significant cause of congestion. Level of service D may also not be achieved within the Central Business District.<sup>1</sup>

In this EIR, if traffic related to the Proposed Project caused a signalized intersection to exceed a V/C ration of 0.85 (mid-LOS D) or added additional traffic to a signalized intersection already at or exceeding a 0.85 ratio, the impact was considered significant. In addition, if an increase in traffic would cause an intersection to drop from LOS A to LOS C or worse, this would also be considered a significant impact.

---

<sup>1</sup> City of Fremont, *Fremont General Plan*, Chapter 8, 1991.

At an all-way stop controlled intersection, if the V/C exceeded LOS C (>C) with or without the project-related traffic, the impact was considered significant. At an unsignalized, one- and two-way stop controlled intersection, traffic (with or without project-related traffic) causing LOS F on any movement was considered a significant impact.

### 3.12.3 IMPACTS OF PROPOSED PROJECT

The 1998 traffic impact analysis section describes the short term cumulative impacts in the vicinity of the station areas; the analysis includes project-generated traffic, and growth in the area. The results are considered the "worst case" traffic related-impacts that could be anticipated by 1998, which is the planned opening date of revenue service on the BART Warm Springs Extension. By 1998, other land uses would be developed in the area; this growth is included in the assessment of short term cumulative impact.

This discussion of 1998 transportation-related impacts serves two purposes. First, the discussion shows how the implementation of the Warm Springs Extension would impact station areas and the surrounding vicinities, and it details the necessary mitigation. Second, the discussion of 1998 short term cumulative impacts complements the later discussion of long term cumulative impacts in horizon year 2010, as detailed by the Fremont General Plan.

#### Direct and Short Term Cumulative Impacts

Transportation-related impacts of the Proposed Project were evaluated from perspectives of station traffic, pedestrian and bicycle access routes, parking demand versus supply, transit demand versus supply (including existing and planned service), and freight railroad operations. The analysis of each of these topics for the Proposed Project is presented below.

**Station Traffic.** The impacts of traffic related to the Proposed Project is discussed for the existing Fremont Station area, and for the proposed Irvington, Warm Springs and South Warm Springs Stations.

**Fremont Station.** At the existing Fremont Station, vehicle activity would be expected to decline as the new stations in Fremont would divert some patrons. Parking demand is expected to decrease by about 27 percent from existing levels, with traffic in the vicinity having a similar decrease. For this reason, the Proposed Project and Alternatives 4

through 11 are anticipated to have beneficial effects on traffic in the vicinity of Fremont Station.

The Proposed Project and BART alternatives leave Fremont Station on an embankment which would block vehicle access between the east and west parking lots. This separation would not significantly affect on-site circulation because both parking lots have separate access routes, and through access is not required.

**Irvington, Warm Springs, and South Warm Springs Stations.** Impacts of the Proposed Project on intersection levels of service, compared to existing traffic conditions, are shown in Table 3.12-8. The Proposed Project's direct and short term cumulative impacts in 1998 are shown in Table 3.12-9. The resultant traffic turning volumes with the Proposed Project superimposed on existing conditions are shown in Figures 3.12-14, 3.12-15 and 3.12-16, for the Irvington, Warm Springs and South Warm Springs stations, respectively. Turning volumes with the Proposed Project at 1998 levels are shown in Figures 3.12-17, 3.12-18 and 3.12-19, for the Irvington, Warm Springs and South Warm Springs stations.

Significant impacts at opening year are expected at the following locations:

- Driscoll Road-Osgood Road/Washington Boulevard would have V/C ratios in excess of 1.00. The LOS would exceed acceptable levels even without the Proposed Project. Traffic volumes due to the Proposed Project would be from about 7.4 percent to 8.7 percent of total traffic at the intersection in 1998.
- Osgood Road-Warm Springs Boulevard/South Grimmer Boulevard is an all-way stop controlled intersection that would be in excess of LOS C. The unacceptable condition would exist even without the Proposed Project. Traffic due to the Proposed Project would be from 7.0 percent (A.M. peak hour) to 8.2 percent (P.M. peak hour) of the total intersection traffic volumes. A peak hour signal warrant check indicates that a signal would probably be warranted in 1998; this impact is significant.
- Fremont Boulevard/I-880 Northbound ramps is a stop controlled intersection expected to operate at LOS F on the westbound-to-southbound left turn in the morning peak hour, with or without the Proposed Project. The Proposed Project would contribute 2.5 percent to the estimated intersection traffic volumes during the morning peak hour in 1998.



**Table 3.12-8**  
**Summary of Intersection Traffic Analysis Results**  
**Existing<sup>1</sup> Plus Proposed Project**

| Intersection                                 | W/out Proposed Project         |            | With Proposed Project |     | BART-Generated Traffic |                      | Significant Impact |
|----------------------------------------------|--------------------------------|------------|-----------------------|-----|------------------------|----------------------|--------------------|
|                                              | LOS                            | V/C        | LOS                   | V/C | Amount                 | Percent <sup>2</sup> |                    |
| <i>Irvington</i>                             |                                |            |                       |     |                        |                      |                    |
| 1. Fremont Bl/Bay St/<br>Washington Bl       | A.M. B (0.62)<br>P.M. B (0.66) |            | B (0.63)<br>B (0.67)  |     | 33<br>30               | 1.7<br>1.2           | No                 |
| 2. Driscoll Rd-Osgood Rd<br>Washington Bl    | D (0.83)<br>C (0.78)           |            | F (1.20)<br>F (1.02)  |     | 116<br>105             | 3.7<br>3.2           | Yes                |
| 3. I-680 SB Ramps/<br>Washington Bl          |                                | D/A<br>E/B | E/A<br>E/B            |     | 33<br>30               | 2.3<br>1.8           | No                 |
| 4. I-680 NB Ramps-Luzon/<br>Washington Bl    | A (0.45)<br>A (0.49)           |            | A (0.52)<br>A (0.58)  |     | 31<br>28               | 2.0<br>1.6           | No                 |
| 5. Osgood Rd/Blacow Rd                       | --<br>--                       |            | A (0.47)<br>A (0.31)  |     | 181<br>165             | 13.3<br>15.7         | No                 |
| 6. Osgood Rd/BART St<br>Irvington            | --<br>--                       |            | A (0.43)<br>A (0.34)  |     | 187<br>176             | 13.6<br>16.5         | No                 |
| <i>Warm Springs</i>                          |                                |            |                       |     |                        |                      |                    |
| 1. Osgood Rd/<br>Durham Rd                   | C (0.74)<br>C (0.77)           |            | C (0.75)<br>C (0.80)  |     | 69<br>63               | 1.8<br>1.7           | No                 |
| 2. I-680 SB Ramps/<br>Durham Rd              | A (0.55)<br>A (0.51)           |            | A (0.56)<br>A (0.52)  |     | 60<br>54               | 1.7<br>1.9           | No                 |
| 3. I-680 NB Ramps/<br>Durham Rd              | A (0.44)<br>A (0.36)           |            | A (0.45)<br>A (0.39)  |     | 40<br>47               | 2.5<br>2.7           | No                 |
| 4. Warm Springs Bl - Osgood<br>Rd/Grimmer Bl | > C<br>> C                     |            | > C<br>> C            |     | 174<br>158             | 7.5<br>8.8           | Yes                |
| 5. Fremont Bl/<br>S. Grimmer Bl              | A (0.42)<br>A (0.38)           |            | A (0.43)<br>A (0.38)  |     | 45<br>41               | 2.4<br>2.3           | No                 |
| 6. Fremont Bl/<br>I-880 NB Ramps             |                                | F/A<br>D/A | F/A<br>E/A            |     | 40<br>36               | 2.7<br>2.2           | Yes                |
| 7. Fremont Blvd/Cushing<br>Rd-I-880 SB Ramps | > C<br>> C                     |            | > C<br>> C            |     | 19<br>26               | 1.0<br>2.2           | Yes                |
| 8. Mohave Dr/<br>Mission Bl                  | B (0.67)<br>E (0.95)           |            | C (0.79)<br>F (1.08)  |     | 250<br>228             | 5.9<br>4.7           | Yes                |
| 9. Warm Springs Bl/BART<br>St W.S. North     | --<br>--                       |            | B (0.62)<br>A (0.55)  |     | 373<br>235             | 16.7<br>11.1         | No                 |
| 10. Warm Springs Bl/<br>BART St W.S. South   | --<br>--                       |            | A (0.54)<br>B (0.64)  |     | 387<br>353             | 17.2<br>15.8         | No                 |
| 11. Warm Springs Bl/<br>Mission Bl           | D (0.82)<br>D (0.85)           |            | C (0.75)<br>E (0.91)  |     | 320<br>292             | 5.4<br>3.9           | Yes                |

Note: For each intersection, LOS and V/C ratio shown as A.M. peak hour on top of PM peak hour. Unsignalized one- and two-way stop controlled intersections are shown as the worst moment for the minor street followed by the worst moment for the major street (e.g. D/A). Unsignalized all-way stop controlled intersections are shown as either better than LOS C (<C) or worse than LOS C (>C).

<sup>1</sup>Existing conditions are based on 1988-1990 traffic volumes.

<sup>2</sup>BART generated traffic as a percent of total approach volume at intersection.

Source: DKS Associates, 1991.

**Table 3.12-8 (cont.)  
Summary of Intersection Traffic Analysis Results  
Existing<sup>1</sup> Plus Proposed Project**

| Intersection                                        | W/out Proposed Project |        | With Proposed Project |     | BART-Generated Traffic |                      | Significant Impact |
|-----------------------------------------------------|------------------------|--------|-----------------------|-----|------------------------|----------------------|--------------------|
|                                                     | LOS                    | V/C    | LOS                   | V/C | Amount                 | Percent <sup>2</sup> |                    |
| <i>South Warm Springs</i>                           |                        |        |                       |     |                        |                      |                    |
| 1. Milmont Dr/<br>Kato Rd                           | A.M.                   | F/C    | E/D                   |     | 269                    | 14.1                 | Yes                |
|                                                     | P.M.                   | F/A    | F/A                   |     | 244                    | 17.7                 |                    |
| 2. Warm Springs Bl/<br>Kato Rd/Scott Creek Rd       | B                      | (0.65) | C (0.80)              |     | 165                    | 5.2                  | Yes                |
|                                                     | E                      | (0.97) | E (0.99)              |     | 150                    | 4.4                  |                    |
| 3. I-680 SB Ramps/<br>Scott Creek Rd                | D/A                    |        | D/A                   |     | 91                     | 4.6                  | No                 |
|                                                     | C/A                    |        | C/A                   |     | 83                     | 4.4                  |                    |
| 4. I-680 NB Ramps/<br>Scott Creek Rd                | A/A                    |        | A/A                   |     | 71                     | 5.3                  | No                 |
|                                                     | A/A                    |        | A/A                   |     | 31                     | 2.8                  |                    |
| 5. N. Milpitas Bl/<br>Dixon Landing Rd              | C (0.80)               |        | D (0.81)              |     | 69                     | 2.5                  | No                 |
|                                                     | B (0.66)               |        | C (0.71)              |     | 63                     | 2.2                  |                    |
| 6. Milmont Dr/<br>Dixon Landing Rd                  | D (0.85)               |        | F (1.08)              |     | 265                    | 9.9                  | Yes                |
|                                                     | A (0.44)               |        | B (0.61)              |     | 240                    | 11.5                 |                    |
| 7. I-880 NB Ramps-California<br>Cr/Dixon Landing Rd | E (0.96)               |        | F (1.12)              |     | 265                    | 9.9                  | Yes                |
|                                                     | C (0.77)               |        | D (0.83)              |     | 240                    | 9.7                  |                    |
| 8. I-880 SB Ramps/<br>Dixon Landing Rd              | A/A                    |        | A/A                   |     | 59                     | 3.8                  | No                 |
|                                                     | A/A                    |        | A/A                   |     | 159                    | 12.6                 |                    |
| 9. Warm Springs Bl/BART<br>St S.W.S. North          | -                      |        | A (0.47)              |     | 8                      | 0.4                  | No                 |
|                                                     | -                      |        | A (0.39)              |     | 7                      | 0.4                  |                    |
| 10. Warm Springs Bl/<br>BART St S.W.S. South        | -                      |        | A (0.54)              |     | 128                    | 6.0                  | No                 |
|                                                     | -                      |        | A (0.44)              |     | 118                    | 5.7                  |                    |
| 11. BART St/S.W.S.<br>South/Kato Rd                 | -                      |        | A (0.44)              |     | 308                    | 26.0                 | No                 |
|                                                     | -                      |        | A (0.31)              |     | 280                    | 56.2                 |                    |

Note: For each intersection, LOS and V/C ratio shown as A.M. peak hour on top of PM peak hour. Unsignalized one- and two-way stop controlled intersections are shown as the worst moment for the minor street followed by the worst moment for the major street (e.g. D/A). Unsignalized all-way stop controlled intersections are shown as either better than LOS C (<C) or worse than LOS C (>C).

<sup>1</sup>Existing conditions are based on 1988-1990 traffic volumes.

<sup>2</sup>BART generated traffic as a percent of total approach volume at intersection.

Source: DKS Associates, 1991.

Table 3.12-9

Summary of Intersection Traffic Analysis Results - Proposed Project  
Year 1998

| Intersection                                  | W/out Proposed Project         |     | With Proposed Project |     | BART-Generated Traffic |              | Significant Impact |
|-----------------------------------------------|--------------------------------|-----|-----------------------|-----|------------------------|--------------|--------------------|
|                                               | LOS                            | V/C | LOS                   | V/C | Amount                 | Percent*     |                    |
| <i>Irvington</i>                              |                                |     |                       |     |                        |              |                    |
| 1. Fremont Bl/Bay St/<br>Washington Bl        | A.M. B (0.64)<br>P.M. D (0.81) |     | B (0.65)<br>D (0.83)  |     | 218<br>200             | 9.4<br>6.6   | No                 |
| 2. Driscoll Rd-Osgood Rd/<br>Washington Bl    | F (1.23)<br>E (0.95)           |     | F (1.39)<br>F (1.04)  |     | 308<br>282             | 8.7<br>7.4   | Yes                |
| 3. I-680 SB Ramps/<br>Washington Bl           | E/A<br>E/C                     |     | E/B<br>E/C            |     | 35<br>32               | 2.2<br>1.8   | No                 |
| 4. I-680 NB Ramps-Luzon/<br>Washington Bl     | A (0.55)<br>B (0.62)           |     | A (0.55)<br>B (0.63)  |     | 34<br>31               | 2.0<br>1.6   | No                 |
| 5. Osgood Rd/Blacow Rd                        | A (0.41)<br>A (0.29)           |     | A (0.41)<br>A (0.29)  |     | 13<br>12               | 1.0<br>1.2   | No                 |
| 6. Osgood Rd/BART St<br>Irvington             | --<br>--                       |     | A (0.44)<br>A (0.41)  |     | 299<br>228             | 18.9<br>19.1 | No                 |
| <i>Warm Springs</i>                           |                                |     |                       |     |                        |              |                    |
| 1. Osgood Rd/<br>Durham Rd                    | C (0.79)<br>D (0.85)           |     | C (0.79)<br>D (0.85)  |     | 78<br>71               | 1.6<br>1.6   | No                 |
| 2. I-680 SB Ramps/<br>Durham Rd               | B (0.64)<br>A (0.59)           |     | B (0.65)<br>B (0.61)  |     | 67<br>61               | 1.5<br>1.8   | No                 |
| 3. I-680 NB Ramps/<br>Durham Rd               | A (0.51)<br>A (0.42)           |     | A (0.52)<br>A (0.44)  |     | 45<br>52               | 2.3<br>2.5   | No                 |
| 4. S. Grimmer Bl/Osgood<br>Rd-Warm Springs Bl | >C<br>>C                       |     | >C<br>>C              |     | 195<br>177             | 7.0<br>8.2   | Yes                |
| 5. Fremont Bl/<br>S. Grimmer Bl               | A (0.49)<br>A (0.44)           |     | A (0.49)<br>A (0.44)  |     | 50<br>46               | 2.2<br>2.2   | No                 |
| 6. Fremont Bl/<br>I-880 NB Ramps              | F/A<br>E/B                     |     | F/A<br>E/B            |     | 44<br>40               | 2.5<br>2.1   | Yes                |
| 7. Fremont Blvd/Cushing<br>Rd-I-880 SB Ramps  | >C<br>>C                       |     | >C<br>>C              |     | 21<br>29               | 0.9<br>2.0   | Yes                |
| 8. Mohave Dr/<br>Mission Bl                   | C (0.80)<br>F (1.25)           |     | D (0.84)<br>F (1.30)  |     | 281<br>256             | 5.5<br>4.4   | Yes                |
| 9. Warm Springs Bl/BART<br>St W.S. North      | --<br>--                       |     | C (0.71)<br>B (0.64)  |     | 417<br>263             | 15.5<br>10.4 | No                 |
| 10. Warm Springs Bl/<br>BART St W.S. South    | --<br>--                       |     | B (0.63)<br>C (0.75)  |     | 434<br>395             | 16.3<br>14.9 | No                 |
| 11. Warm Springs Bl/<br>Mission Bl            | E (0.96)<br>F (1.02)           |     | E (0.97)<br>F (1.02)  |     | 359<br>326             | 5.1<br>3.6   | Yes                |

Note: For each intersection, LOS and V/C ratio is shown as AM peak hour on top of PM peak hour. Unsignalized one- and two-way stop controlled intersections are shown as the worst movement from the minor street followed by the worst movement from the major street (e.g. D/A). Unsignalized all-way stop controlled intersections are shown as either better than LOS C (<C) or worse than LOS C (>C).

\*BART generated traffic as a percent of total volume at intersection.

Source: DKS Associates, 1991.

Table 3.12-9 (cont.)

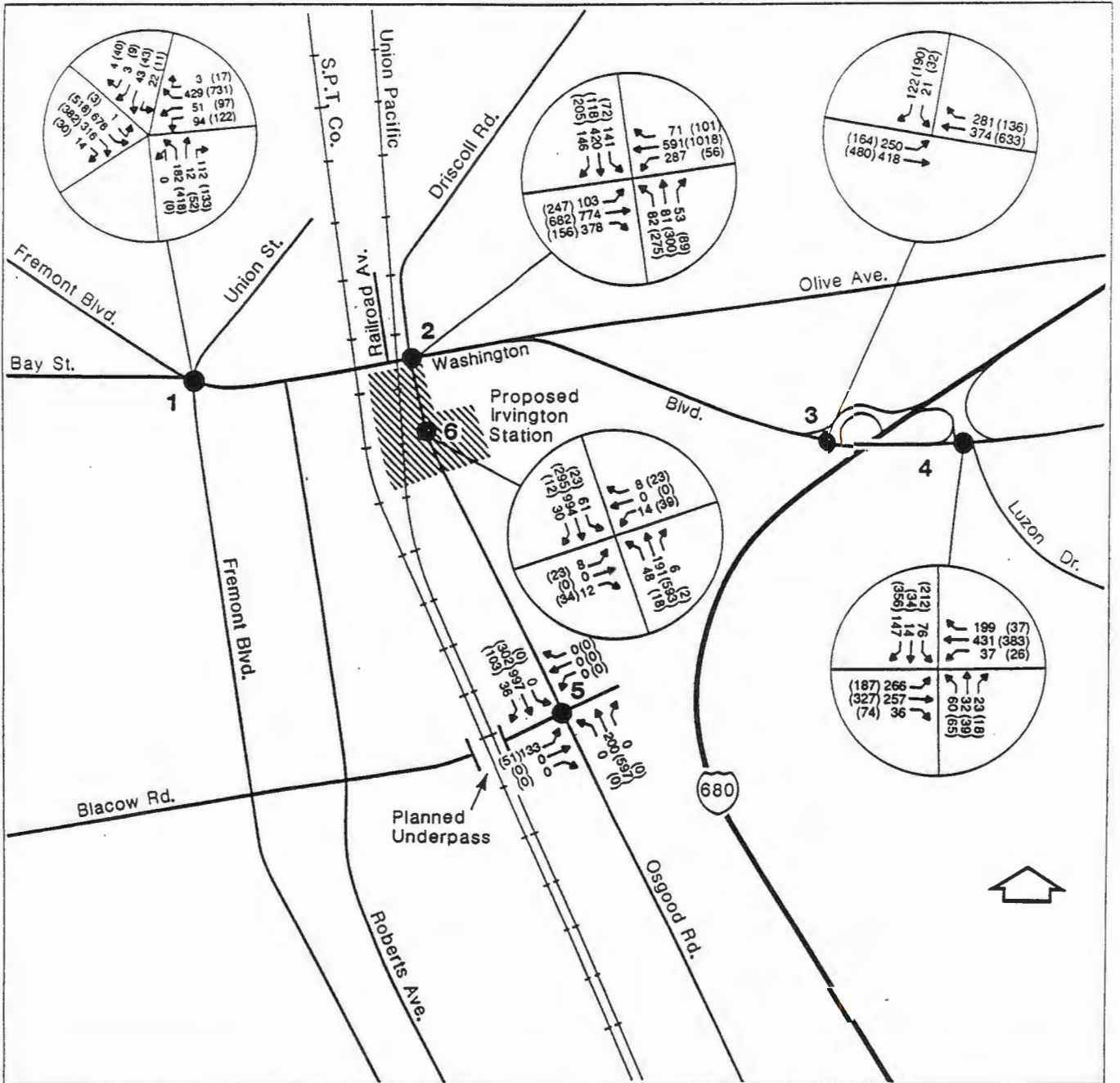
Summary of Intersection Traffic Analysis Results - Proposed Project  
Year 1998

| Intersection                                        | W/out Proposed Project |     | With Proposed Project |     | BART-Generated Traffic |          | Significant Impact |
|-----------------------------------------------------|------------------------|-----|-----------------------|-----|------------------------|----------|--------------------|
|                                                     | LOS                    | V/C | LOS                   | V/C | Amount                 | Percent* |                    |
| <i>South Warm Springs</i>                           |                        |     |                       |     |                        |          |                    |
| 1. Milmont Dr/<br>Kato Rd                           | F/D                    |     | F/E                   |     | 290                    | 12.8     | Yes                |
|                                                     | F/A                    |     | F/B                   |     | 263                    | 16.2     |                    |
| 2. Warm Springs Bl/<br>Kato Rd/Scott Creek Rd       | C (0.71)               |     | C (0.77)              |     | 178                    | 4.7      | Yes                |
|                                                     | D (0.82)               |     | D (0.87)              |     | 161                    | 4.0      |                    |
| 3. I-680 SB Ramps/<br>Scott Creek Rd                | E/A                    |     | E/A                   |     | 98                     | 4.2      | No                 |
|                                                     | D/A                    |     | D/A                   |     | 89                     | 4.0      |                    |
| 4. I-680 NB Ramps/<br>Scott Creek Rd                | A/A                    |     | A/A                   |     | 76                     | 4.7      | No                 |
|                                                     | A/A                    |     | A/A                   |     | 34                     | 2.5      |                    |
| 5. N. Milpitas Bl/<br>Dixon Landing Rd              | E (0.93)               |     | E (0.94)              |     | 75                     | 2.3      | Yes                |
|                                                     | D (0.86)               |     | D (0.88)              |     | 68                     | 2.0      |                    |
| 6. Milmont Dr/<br>Dixon Landing Rd                  | F (1.10)               |     | F (1.28)              |     | 285                    | 9.0      | Yes                |
|                                                     | A (0.58)               |     | B (0.69)              |     | 259                    | 10.5     |                    |
| 7. I-880 NB Ramps-California<br>Cr/Dixon Landing Rd | F (1.16)               |     | F (1.32)              |     | 285                    | 8.5      | Yes                |
|                                                     | D (0.82)               |     | E (0.94)              |     | 259                    | 8.8      |                    |
| 8. I-880 SB Ramps/<br>Dixon Landing Rd              | A/A                    |     | A/A                   |     | 64                     | 3.5      | No                 |
|                                                     | A/A                    |     | A/A                   |     | 171                    | 11.5     |                    |
| 9. Warm Springs Rd/BART<br>St S.W.S. North          | --                     |     | A (0.54)              |     | 8                      | 0.3      | No                 |
|                                                     | --                     |     | A (0.46)              |     | 7                      | 0.3      |                    |
| 10. Warm Springs Rd/<br>BART St S.W.S. SE           | --                     |     | B (0.62)              |     | 139                    | 5.5      | No                 |
|                                                     | --                     |     | A (0.51)              |     | 126                    | 5.1      |                    |
| 11. Kato Rd/BART St<br>S.W.S. South                 | --                     |     | A (0.49)              |     | 332                    | 24.0     | No                 |
|                                                     | --                     |     | A (0.33)              |     | 301                    | 53.5     |                    |

Note: For each intersection, LOS and V/C ratio is shown as AM peak hour on top of PM peak hour. Unsignalized one- and two-way stop controlled intersections are shown as the worst movement from the minor street followed by the worst movement from the major street (e.g. D/A). Unsignalized all-way stop controlled intersections are shown as either better than LOS C (<C) or worse than LOS C (>C).

\*BART generated traffic as a percent of total volume at intersection.

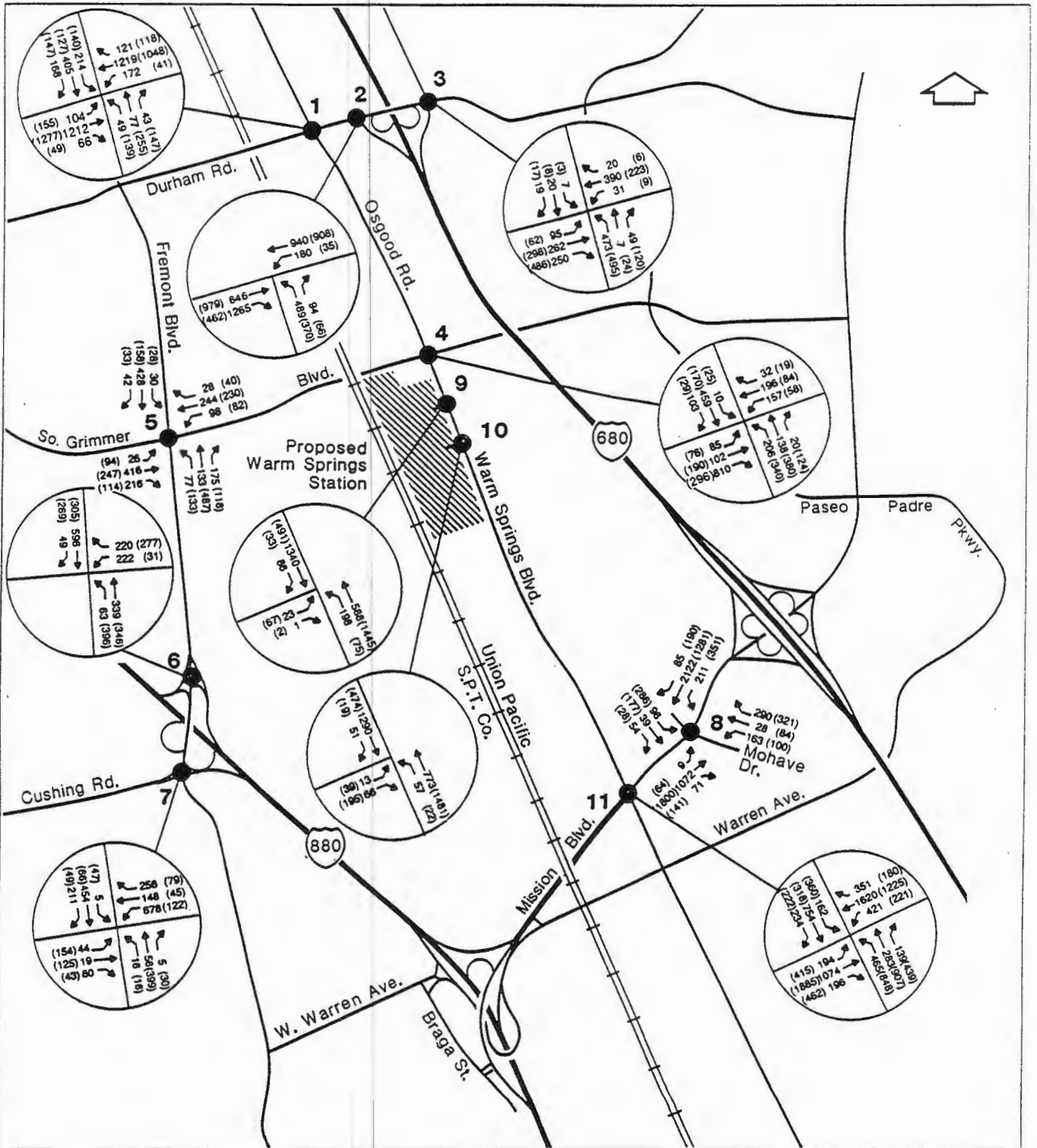
Source: DKS Associates, 1991.



**Figure 3.12-14**  
**EXISTING CONDITIONS WITH**  
**PROJECTED 1991 BART TRAFFIC**  
**PEAK HOUR TURN VOLUMES**  
**Proposed Project**  
**Irvington Station Vicinity**

- 00 AM Peak Hour
- (00) PM Peak Hour
- Intersections Evaluated in Traffic Analysis

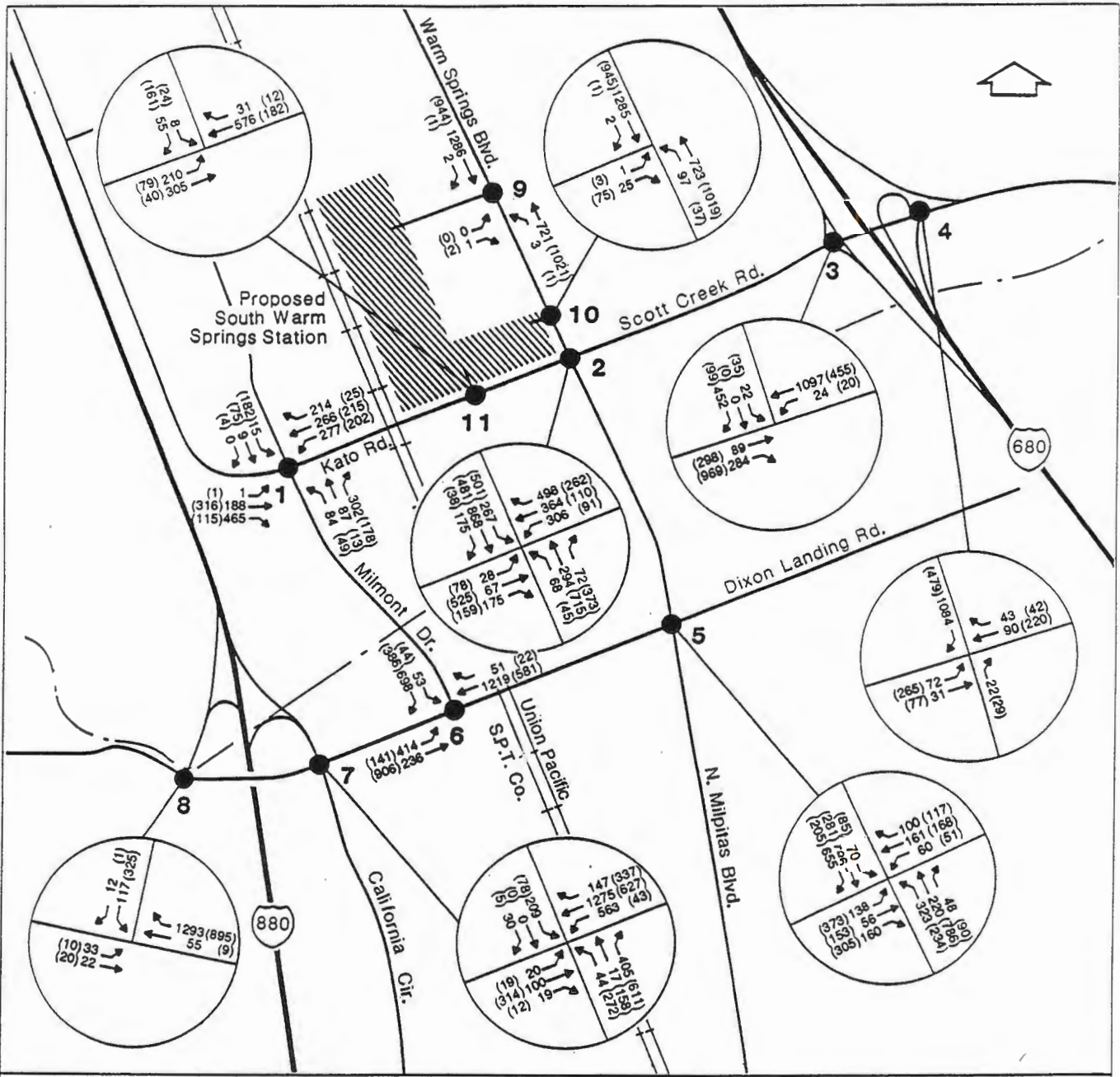
Source: DKS Associates, 1991



**Figure 3.12-15**  
**EXISTING CONDITIONS WITH**  
**PROJECTED 1991 BART TRAFFIC**  
**PEAK HOUR TURN VOLUMES**  
**Proposed Project**  
**Warm Springs Station Vicinity**

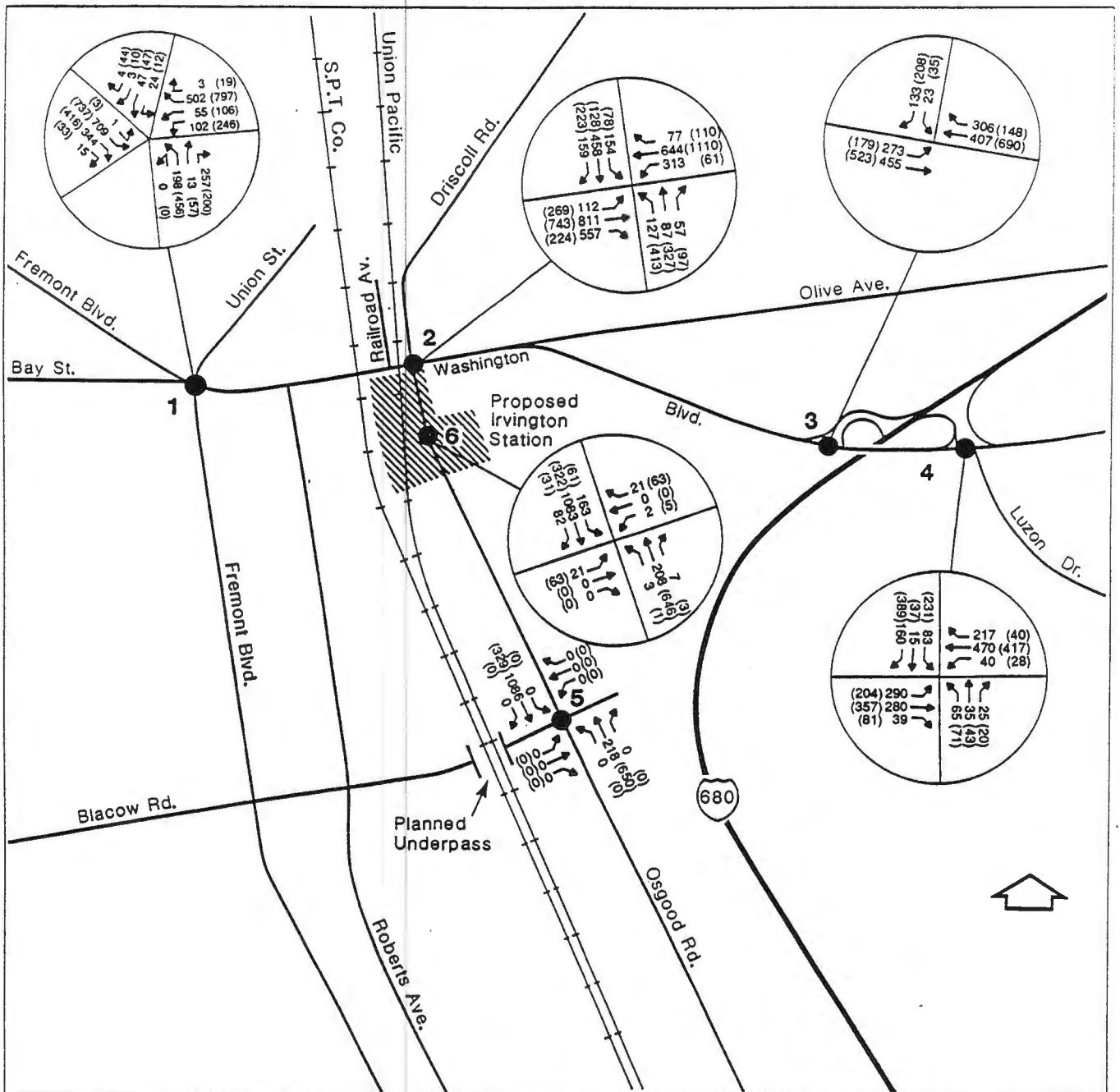
- 00 AM Peak Hour
- (00) PM Peak Hour
- Intersections Evaluated in Traffic Analysis

Source: DKS Associates, 1991



**Figure 3.12-16**  
**EXISTING CONDITIONS WITH**  
**PROJECTED 1991 BART TRAFFIC**  
**PEAK HOUR TURN VOLUMES**  
**Proposed Project**  
**South Warm Springs Station Vicinity**

- 00 AM Peak Hour
- (00) PM Peak Hour
- Intersections Evaluated in Traffic Analysis

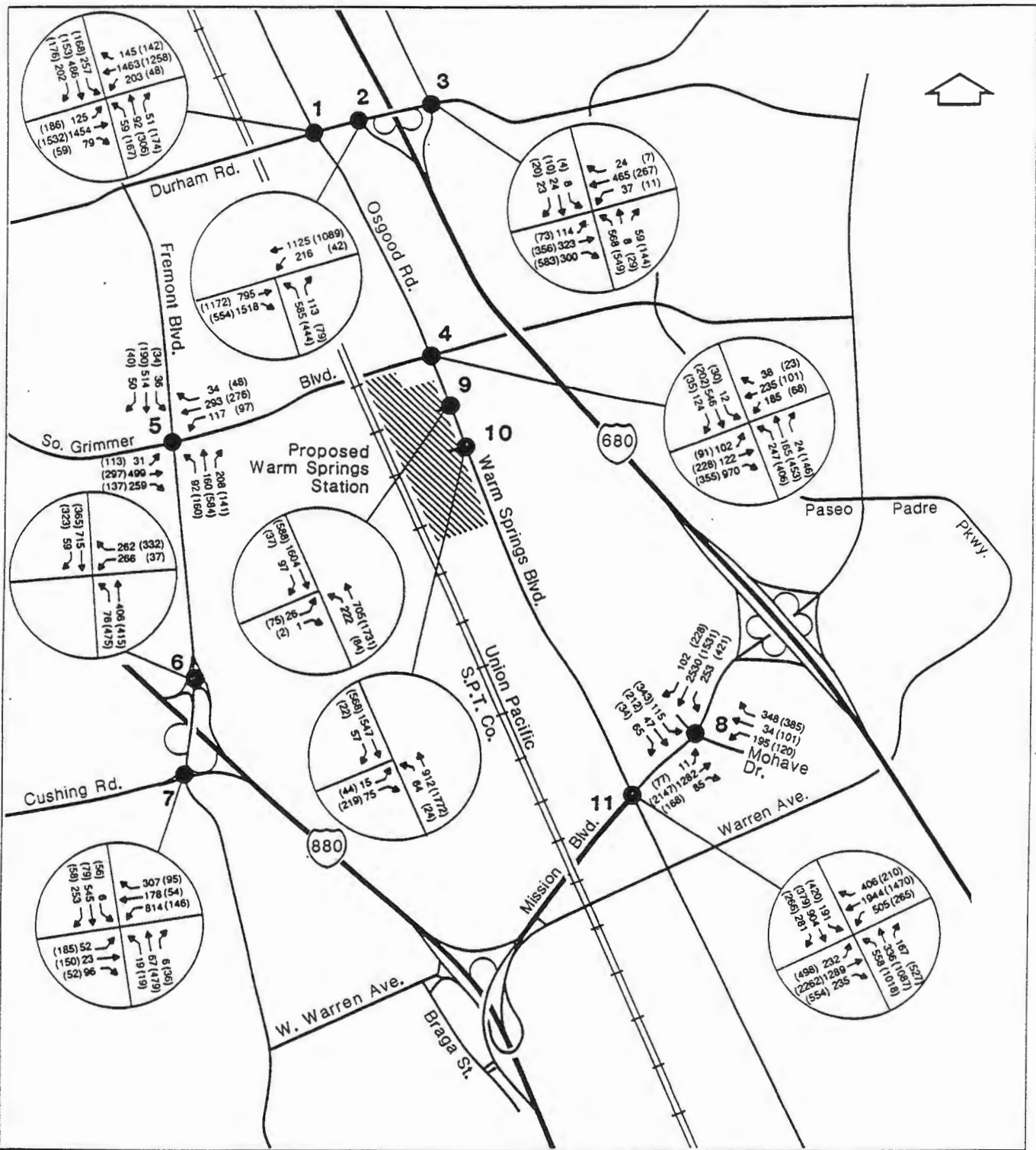


**Figure 3.12-17**  
**1998 PEAK HOUR TURN VOLUMES**  
**Proposed Project**  
**Irvington Station Vicinity**

00 AM Peak Hour  
 (00) PM Peak Hour  
 ● Intersections Evaluated in Traffic Analysis

Source: DKS Associates, 1991

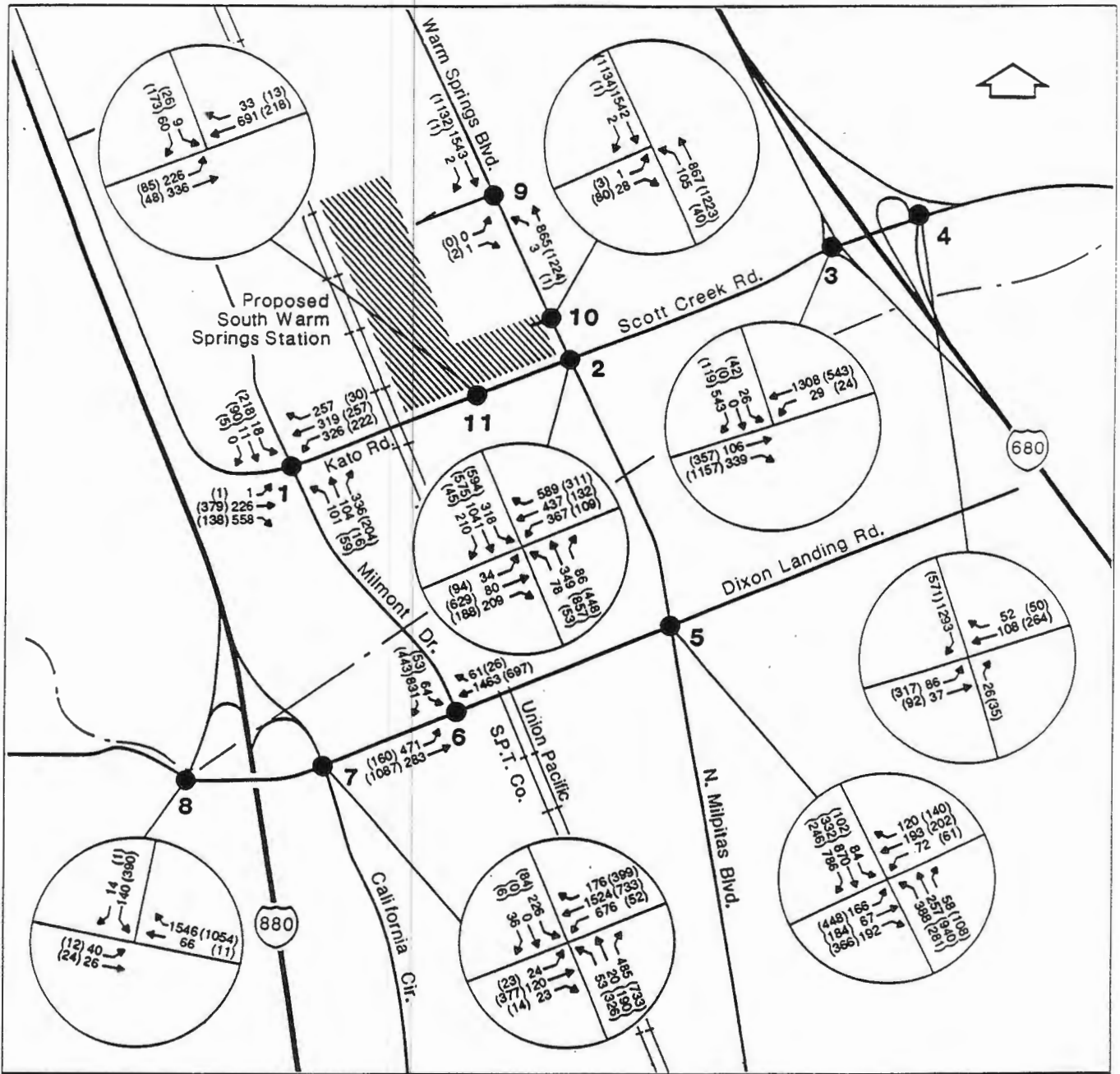




**Figure 3.12-18**  
**1998 PEAK HOUR TURN VOLUMES**  
**Proposed Project**  
**Warm Springs Station Vicinity**

- 00 AM Peak Hour
- (00) PM Peak Hour
- Intersections Evaluated in Traffic Analysis

Source: DKS Associates, 1991



**Figure 3.12-19**  
**1998 PEAK HOUR VOLUMES**  
**Proposed Project**  
**South Warm Springs Station Vicinity**

- 00 AM Peak Hour
- (00) PM Peak Hour
- Intersections Evaluated in Traffic Analysis

Source: DKS Associates, 1991

### 3.12 Transportation

- Fremont Boulevard/Cushing Road-I-880 Southbound Ramps is an all-way stop controlled intersection that would operate worse than LOS C whether or not the Proposed Project is built. The Proposed Project would be 0.9 percent (A.M. peak hour) to 2.0 percent (P.M. peak hour) of the total intersection traffic volumes. The intersection would meet peak hour signal warrants.
- Mohave Drive/Mission Boulevard has a projected V/C ratio in excess of 1.00 with or without the Proposed Project in the evening peak hour. The Proposed Project would account for 4.4 percent of the total intersection P.M. peak hour traffic volumes.
- Warm Springs Boulevard/Mission Boulevard would be at or near capacity in both A.M. and P.M. peak hours with or without the Proposed Project. The Proposed Project would account for 3.6 percent of P.M. peak hour traffic volumes and 5.1 percent of A.M. peak hour traffic volumes.
- Milmont Drive/Kato Road, a two-way stop controlled intersection would operate at LOS F on the left turn movements from Milmont Drive onto Kato Road (A.M. and P.M. peak hours) whether or not the Proposed Project is built. The Proposed Project would contribute between 12.8 percent (A.M. peak hour) and 16.2 percent (P.M. peak hour) to the total intersection traffic volumes.
- Warm Springs Boulevard/Kato Road-Scott Creek Road would have evening peak hour conditions in excess of capacity whether or not the Proposed Project is built. About 4.0 percent of the traffic volumes at this intersection would be due to the Proposed Project.
- North Milpitas Boulevard/Dixon Landing Road would operate at LOS E (V/C ratio of 0.94) in the A.M. peak hour with the Proposed Project. The LOS E conditions would occur with or without the Proposed Project, which would account for 2.3 percent of A.M. peak hour traffic volumes at this intersection location.
- Milmont Drive/Dixon Landing Road intersection would operate over capacity both with and without the Proposed Project in the A.M. peak hour. The Proposed Project would contribute 8.5 percent to total traffic volumes through this intersection.
- I-880 Northbound Ramps-California Circle/Dixon Landing Road intersection would operate over capacity in the morning peak hour, and at LOS E in the evening peak

hour. The LOS E operation condition would occur with or without the Proposed Project. The Proposed Project would account for 8.5 of the traffic volumes at this intersection in the morning peak hour.

**Pedestrian and Bicycle Routes.** Here, the impact of the proposed BART stations on both BART and non-BART related pedestrian and bicycle movements is discussed. The analysis included a review of access routes and traffic circulation, as a means to evaluate how pedestrians and bicyclists would move through the area. A significant impact was found if the Proposed Project would increase traffic hazards to bicyclists or pedestrians.

**Irvington Station.** There are no dedicated bike paths in the area that would serve this station. Bicyclists would have to share the traffic lane with automobiles. Bicycle access from the north and south would be acceptable if Fremont implements plans to widen Washington Boulevard and Driscoll Road to four lanes, with no parking and 14 foot curb lanes. In addition, Roberts Avenue would serve as a good alternative bicycle route from the south. If the planned road widenings do not occur, there could be a significant impact on bicycle access.

From the west, most bicycle access would be via Blacow Road and Washington Boulevard. The existing portions of Blacow Road are adequate for safe bicycle travel. However, the proposed underpass of Blacow Road between Roberts and Osgood could be a bottleneck because of constrained width and inadequate lighting. This is a potentially significant impact. Washington Boulevard between Fremont Boulevard and the station site is expected to see considerable increases in traffic with little opportunity for widening. This is a potentially significant impact on bicycle access.

In terms of pedestrian access, all main access routes have, or will have sidewalks. The only exception is Roberts Avenue, which has discontinuous sidewalks along its length. This route could serve as a key pedestrian path to the station from the neighborhoods to the southwest of the station. This is a potentially significant impact. If planned roadway improvements in the area do not occur (such as on Osgood and Driscoll Roads), there could be significant impacts on pedestrian access.

**Warm Springs Station.** The Warm Springs Station will be served primarily by Osgood Road, Warm Springs Boulevard, and Grimmer Boulevard. As these facilities are widened to four lanes, sufficient width for six-foot bicycle lanes and sidewalks is expected to be

### 3.12 Transportation

provided. Should the streets not be widened by the time the BART station opens, this would be a significant impact.

**South Warm Springs Station.** Bicycle access on Warm Springs Boulevard and Scott Creek/Kato Road is expected to be acceptable. The railroad tracks west of the project could pose a bottleneck to pedestrian travel from the industrial parks to just west of the station. This is a significant impact that should be mitigated. Other pedestrian traffic should be adequately accommodated by sidewalks.

**Parking.** The proposed parking lots in the station concepts are sized to meet the year 2010 parking demand (discussed under "long term cumulative impacts"). The demand under existing conditions and year 1998 will be less than the supply and there will be no significant impact on parking, either directly or in the context of short term cumulative impacts.

**Transit.** Access to and from the proposed BART stations will be provided by AC Transit, and Santa Clara County Transit District (SCCTA). The patronage analysis assumed implementation of AC Transit's Comprehensive Service Plan (CSP) and change in express and local SCCTA bus service to the southernmost BART station. The AC Transit CSP for the Fremont area has not yet been adopted by the District. Discussions with AC Transit staff indicate that the CSP will probably be implemented in 1994. Its implementation has been considered as a part of the Proposed Project.

**Irvington Station.** AC Transit's CSP for Fremont, Newark and Union City indicates a transit center in Irvington in the vicinity of the proposed Irvington station. This transit center would be in place whether or not BART provides a station at this site. Seven transit lines would use this center. They are shown in the text box at right.

Implementation of the AC Transit CSP was assumed in the patronage analysis for this project. An estimated 500 persons per day would connect to BART from AC Transit buses in year 2010 (less in 1998 and under existing conditions).<sup>1</sup> The conceptual plans for the Irvington Station allows space for bus loading; final design would include consultation with AC Transit.

---

<sup>1</sup> Based on MTC Regional Transportation Model.

**Warm Springs Station.** The AC Transit CSP shows one route passing near the proposed Warm Springs Station. This route (Route 31) would extend from the Irvington Transit Center to Weller and South Main Transit Center (Milpitas). Discussions with AC Transit staff indicate that if a BART station were constructed in Warm Springs, it is possible that AC Transit would modify service to connect to that station.<sup>1</sup>

It is estimated that 40 persons would use AC Transit to connect with BART at Warm Springs on an average daily basis in year 2010 (less in 1998 and under existing conditions). The conceptual sketches for the Warm Springs Station also provides an area for bus loading, which would be sized in consultation with AC Transit.

**South Warm Springs Station.** The AC Transit CSP shows two routes passing the vicinity of the proposed South Warm Springs Station. Route 31 would extend from the Irvington Transit Center to Weller and South Main Transit Center (Milpitas). Line 32X would extend from the Fremont Station to the Warm Springs Industrial Area. Discussions with AC Transit staff indicate that if a BART station were constructed in South Warm Springs, it is possible that AC Transit would modify service to connect to that station.<sup>2</sup>

It has also been assumed that SCCTD would modify its express routes to serve the South Warm Springs Station. Five express bus routes were assumed, with service to and from downtown San Jose, San Jose Airport, Mission College (Santa Clara), Lockheed (Sunnyvale), and Mayfield Mall (Mountain View). In addition, four local buses were assumed to extend service to the new South Warm Springs Station, including:

**AC Transit Lines serving the vicinity of the Irvington Station**

- 24 *Fremont BART Station to Warm Springs*
- 30 *Fremont BART Station to Irvington Transit Center*
- 31 *Irvington Transit Center to Weller & South Main Transit Center -- Milpitas (connection with Santa Clara County Transit District)*
- 35 *Union City to Irvington Transit Center*
- 36 *Fremont BART Station to Irvington Transit Center*
- 37 *Union City to Ohlone College*
- 38 *Fremont BART Station to Irvington Transit Center.*

Source: AC Transit Comprehensive Service Plan

<sup>1</sup> Telephone communication between Jeff Buxbaum (DKS Associates) and Debra King (AC Transit) on April 30, 1991.

<sup>2</sup> Ibid.

### 3.12 Transportation

- 20 -- Milpitas/Mountain View
- 71 -- Evergreen (East San Jose)
- 33CW -- Milpitas CBD
- 33CCW -- Milpitas CBD

In the year 2010, under the long term cumulative impact conditions, an estimated 4,440 persons per day would be expected to make a bus-BART transfer at the South Warm Springs Station; fewer transfers would be expected in 1998 and under existing conditions. An additional 630 person trips would be expected to use the South Warm Springs Station as a transfer point for other transportation services.

The South Warm Springs Station conceptual plan shows space for bus loading, which would be sized in consultation with AC Transit and SCCTD.

At all station locations, the Proposed Project would have a beneficial impact on transit service by providing more convenient station options on the Fremont line than does currently exist.

**Freight Railroad Operations.** Two railroads operate in the proposed BART extension corridor, the SPTCo and the UPRR. Operations and planning representatives of both companies were contacted to determine existing operations, future plans, and the potential for disruption of rail freight service due to the BART extension.

**Southern Pacific Transportation Company (SPTCo).** The SPTCo track handles up to eight trains per day, varying in length from 5 to 90 cars. About 60 percent of these are "daytime," i.e. between 6 A.M. and 8 P.M. None of the trains go over the Altamont Pass. The longer trains are Oakland-Salinas and Oakland-Los Angeles. The shorter ones are moving cars between operations in Oakland and Santa Clara.

SPTCo representatives indicated that the proposed BART extension would have no adverse effect on SPTCo rail freight operations in the corridor, since they are blocked from property access by the Union Pacific Railroad (UPRR) tracks even without the BART tracks.<sup>1</sup>

---

<sup>1</sup> Telephone conversation with Jim Strong of SPTCo on February 2, 1990.

### 3.12 Transportation

**Union Pacific Railroad (UPRR).** The UPRR tracks currently handle the following level of traffic:<sup>1</sup>

- Four "line haul" moves per day, with two into Milpitas and two out of Milpitas. Each train has from 50 to 100 cars.
- Four local moves per day, with two in and two out, and each trains has about 25 cars.

UPRR estimates that future growth at NUMMI would result in an additional two to four moves per day.

Current spur line activity was estimated as follows:

- At Washington Boulevard (Milepost 3.4), the spur receives sporadic activity of about three moves per month.
- Between Grimmer Boulevard and Durham Road, the "Inland Steel Spur" (Milepost 4.8) is not currently used, but has potential for future use.
- Between Grimmer Boulevard and Warren Avenue there is a 3-track interchange yard which receives four moves per day. This yard will not be affected by the BART extension.

For both SPTCo and UPRR, the Proposed Project would not pose significant impacts to rail movements.

#### **Cumulative Impacts**

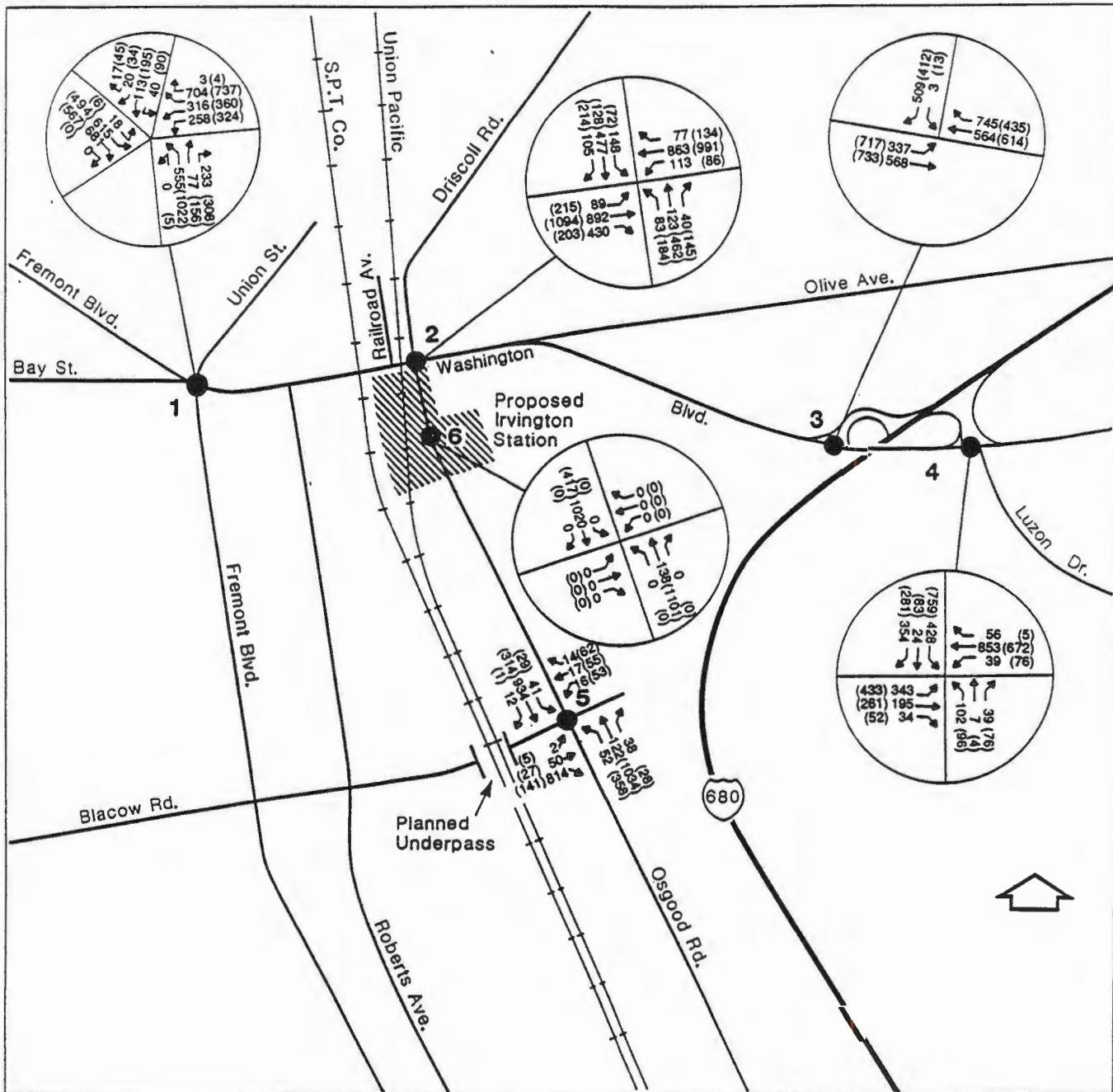
The long term cumulative impact analysis was based on growth forecasts from the Fremont General Plan to year 2010 levels. The General Plan considers development which would be initiated by implementation of the BART extension.

**Station Traffic.** Figures 3.12-20 through 3.12-25 show the year 2010 A.M. and P.M. traffic volumes expected at the intersections in the vicinity of the three proposed BART stations;

---

<sup>1</sup> Telephone conversation with Dave Burns of UPRR on February 2, 1990.

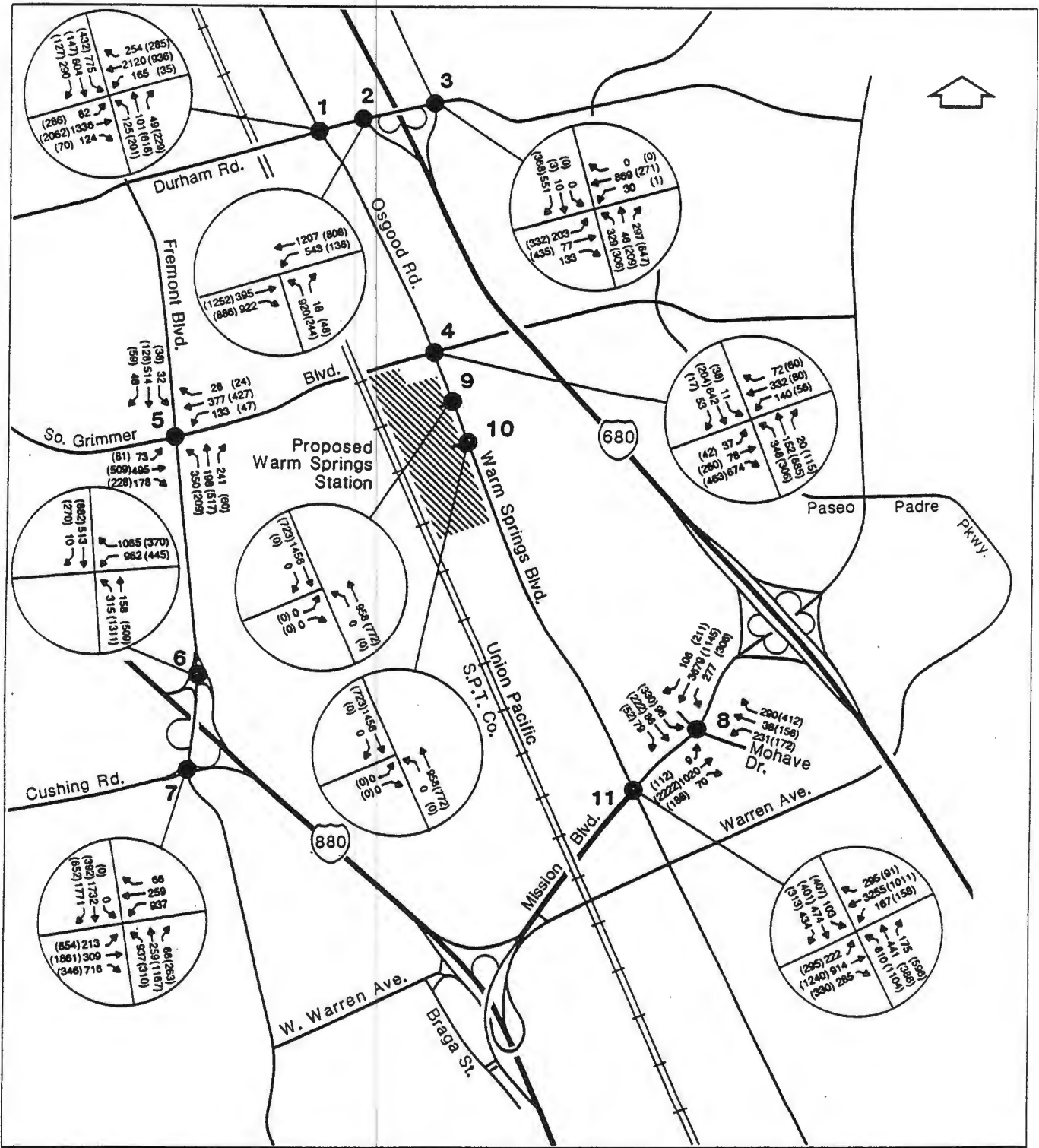




**Figure 3.12-20**  
**2010 PEAK HOUR TURN VOLUMES**  
**No BART Extension**  
**Irvington Station Vicinity**

- 00 AM Peak Hour
- (00) PM Peak Hour
- Intersections Evaluated in Traffic Analysis

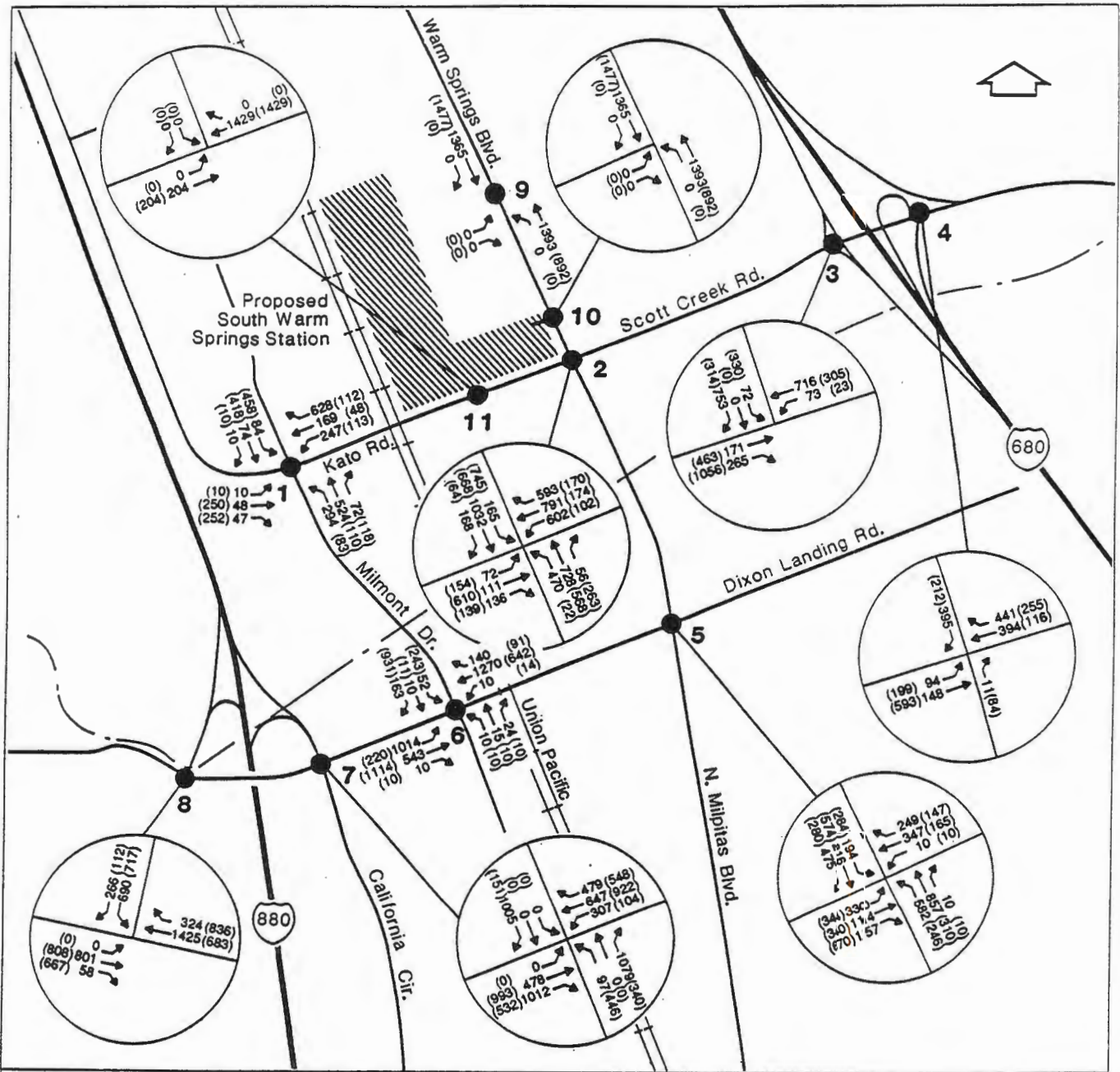
Source: DKS Associates, 1991



**Figure 3.12-21**  
**2010 PEAK HOUR TURN VOLUMES**  
**No BART Extension**  
**Warm Springs Station Vicinity**

00 AM Peak Hour  
 (00) PM Peak Hour  
 ● Intersections Evaluated in Traffic Analysis

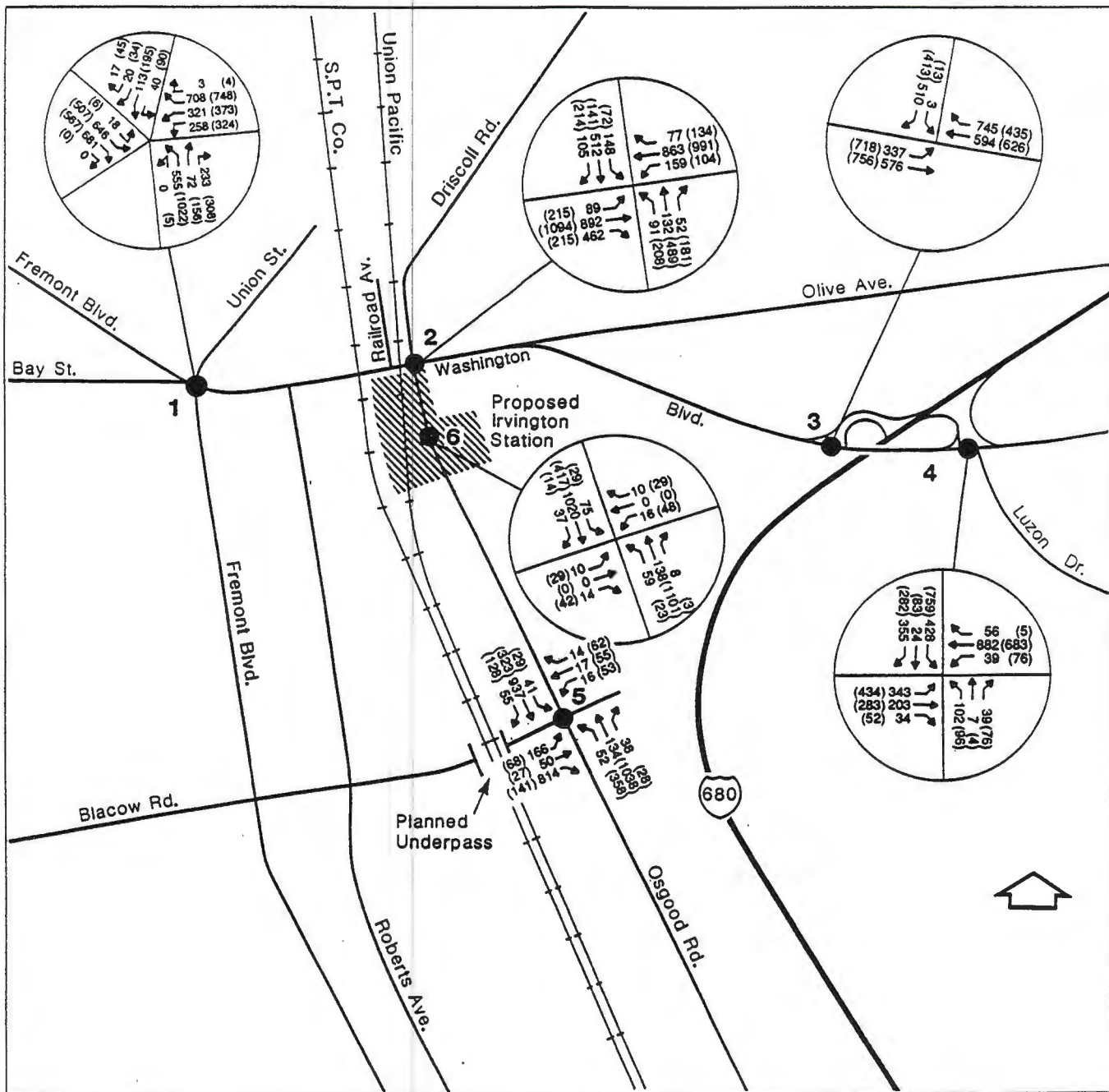
Source: DKS Associates, 1991



**Figure 3.12-22**  
**2010 PEAK HOUR TURN VOLUMES**  
**No BART Extension**  
**South Warm Springs Station Vicinity**

- 00 AM Peak Hour
- (00) PM Peak Hour
- Intersections Evaluated in Traffic Analysis

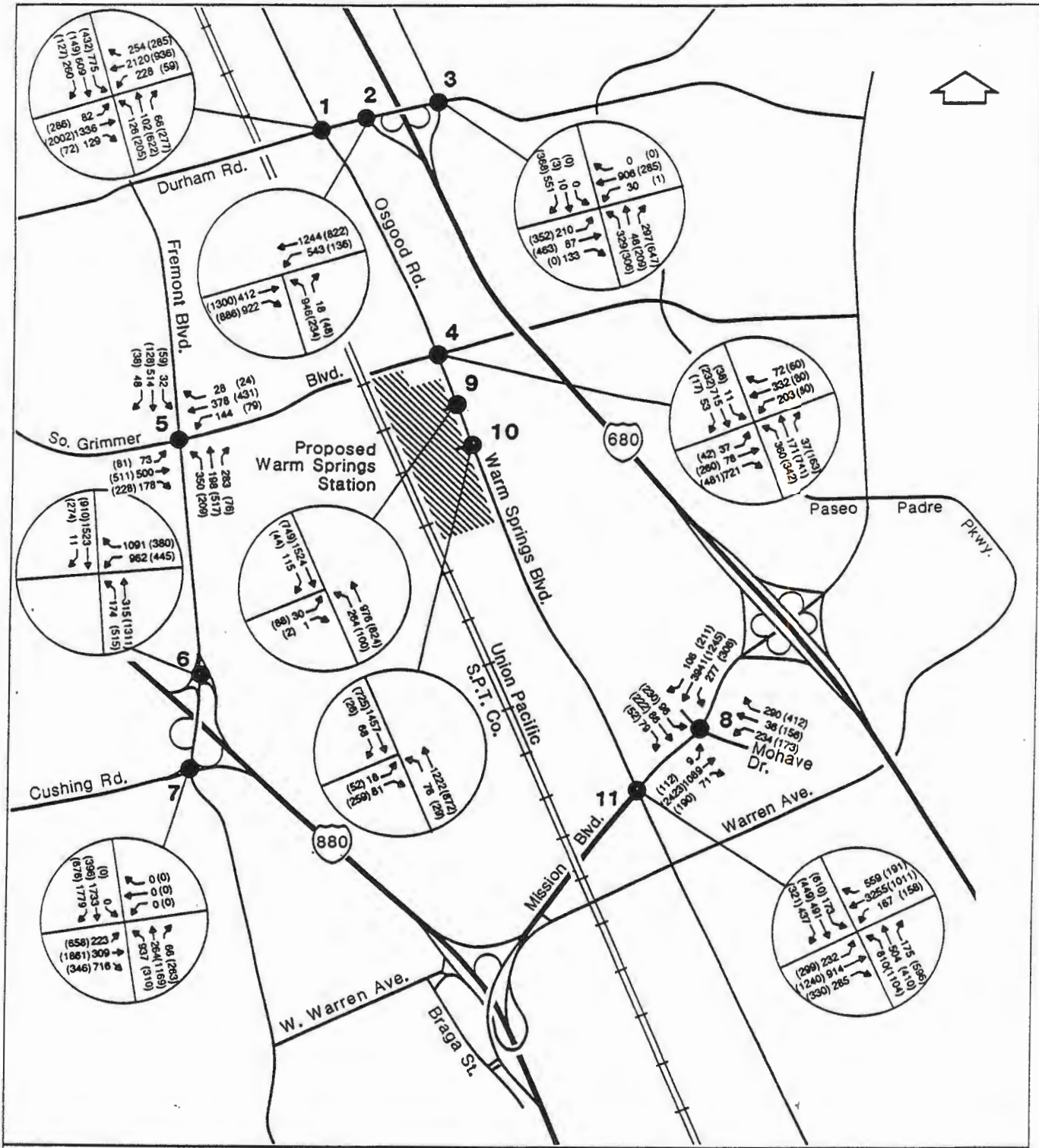
Source: DKS Associates, 1991



**Figure 3.12-23**  
**2010 PEAK HOUR TURN VOLUMES**  
**BART Extension Proposed Project**  
**Irvington Station Vicinity**

- 00 AM Peak Hour
- (00) PM Peak Hour
- Intersections Evaluated in Traffic Analysis

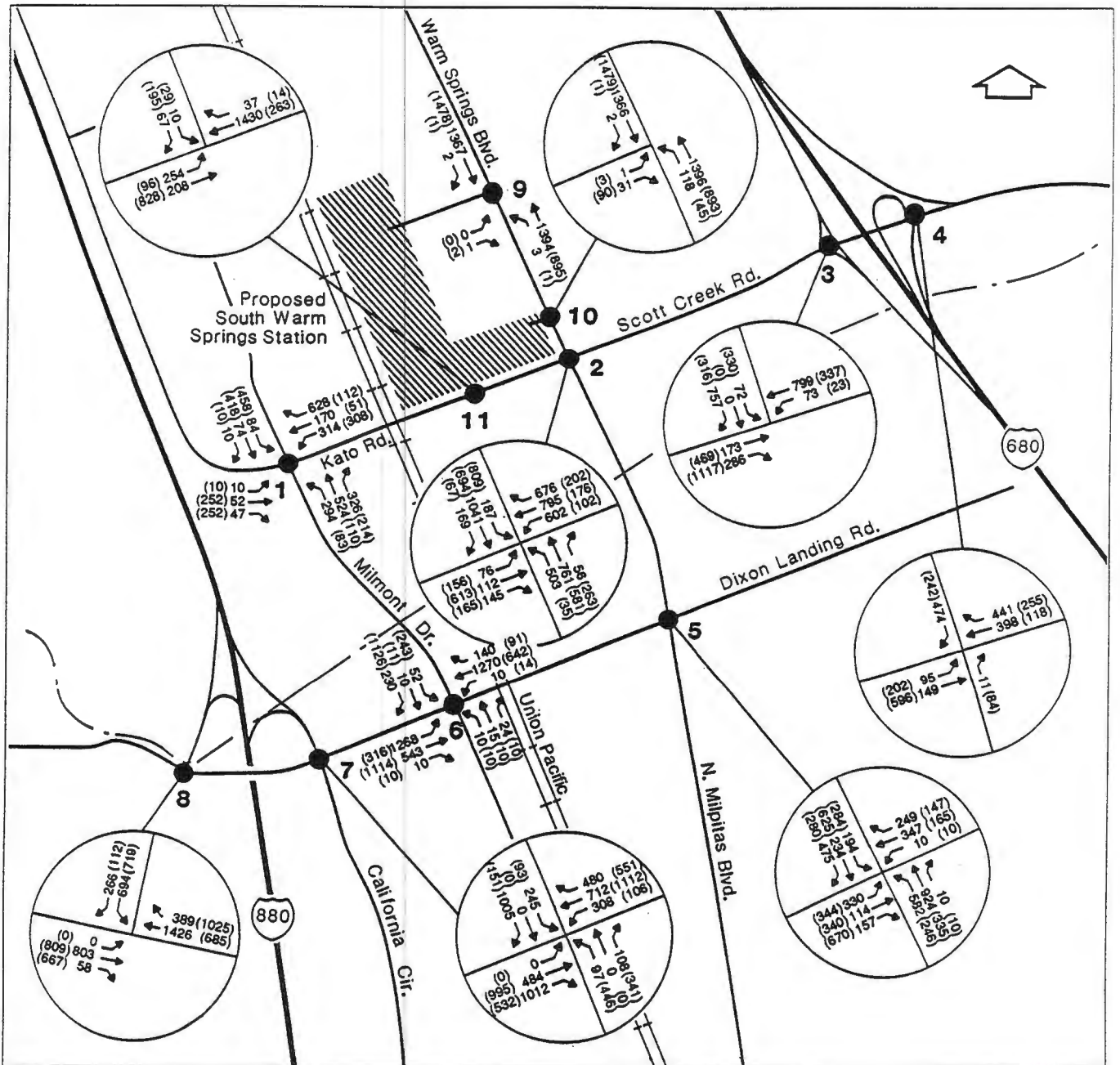
Source: DKS Associates, 1991



**Figure 3.12-24**  
**2010 PEAK HOUR TURN VOLUMES**  
**BART Extension Proposed Project**  
**Warm Springs Station Vicinity**

- 00 AM Peak Hour
- (00) PM Peak Hour
- Intersections Evaluated in Traffic Analysis

Source: DKS Associates, 1991



**Figure 3.12-25**  
**2010 PEAK HOUR TURN VOLUMES**  
**BART Extension Proposed Project**  
**South Warm Springs Station Vicinity**

- 00 AM Peak Hour
- (00) PM Peak Hour
- Intersections Evaluated in Traffic Analysis

traffic volumes are shown with and without the Proposed Project. The effect of the Proposed Project on traffic LOS in year 2010 is summarized in Table 3.12-10.

**Fremont Station.** Use of the Fremont Station would be less with the Proposed Project than without it, therefore there would be no adverse traffic impacts in its vicinity. Impacts of changes in circulation due to the extension would not be significant (see discussion under Direct Impacts).

**Irvington, Warm Springs and South Warm Springs Stations.** The Proposed Project would have significant cumulative (year 2010) impacts at the following intersections:

- Fremont Boulevard/Bay Street/Washington Boulevard would have a V/C ratio in excess of 1.00 both with and without the Proposed Project. The Proposed Project would account for between 0.8 percent (A.M. peak hour) to 1.1 percent of the total intersection traffic volumes (P.M. peak hour).
- I-680 Southbound Ramps/Washington Boulevard, a one-way stop controlled intersection would operate at LOS F on two movements in the P.M. peak hour. However, this poor LOS would effect only 34 vehicles, and a traffic signal would not be warranted. The proposed extension project would account for 1.2 percent of the total traffic volumes at this intersection. This condition would exist with or without the Proposed Project.
- Osgood Road/Durham Road would operate at LOS E in the morning peak hour with or without the Proposed Project in year 2010. The BART extension would contribute 1.5 percent to traffic volumes at this intersection.
- I-680 Southbound Ramps/Durham Road would operate at LOS E (V/C = 0.91) with the BART extension in the morning peak hour. Without the BART extension, the V/C ratio would be 0.88, and the level of service would be D. The Proposed Project would contribute 2.0 percent to the total traffic volumes at this intersection.
- Fremont Boulevard/Cushing Road-I-880 Southbound Ramps would operate at LOS F with or without the Proposed Project in the P.M. peak hour. The Proposed Project would account for 0.4 percent of morning peak hour traffic at this intersection.

**Table 3.12-10**

**Summary of Intersection Traffic Analysis Results - Proposed Project  
Year 2010 (Cumulative Impact)**

| Intersection                                  | W/out Proposed Project         |     | With Proposed Project |     | BART-Generated Traffic |              | Significant Impact |
|-----------------------------------------------|--------------------------------|-----|-----------------------|-----|------------------------|--------------|--------------------|
|                                               | LOS                            | V/C | LOS                   | V/C | Amount                 | Percent*     |                    |
| <i>Irvington</i>                              |                                |     |                       |     |                        |              |                    |
| 1. Fremont Bl/Bay St/<br>Washington Bl        | A.M. F (1.03)<br>P.M. F (1.05) |     | F (1.03)<br>F (1.05)  |     | 40<br>37               | 1.1<br>0.8   | Yes                |
| 2. Driscoll Rd-Osgood Rd/<br>Washington Bl    | A (0.60)<br>C (0.78)           |     | B (0.66)<br>C (0.80)  |     | 142<br>130             | 4.0<br>3.2   | No                 |
| 3. I-680 SB Ramps/<br>Washington Bl           | E/D<br>F/F                     |     | E/D<br>F/F            |     | 40<br>37               | 1.4<br>1.2   | Yes                |
| 4. I-680 NB Ramps-Luzon/<br>Washington Bl     | C (0.74)<br>C (0.74)           |     | C (0.76)<br>C (0.74)  |     | 38<br>35               | 1.5<br>1.2   | No                 |
| 5. Osgood Rd/Blacow Rd                        | A (0.45)<br>A (0.54)           |     | A (0.55)<br>A (0.58)  |     | 221<br>203             | 9.4<br>8.8   | No                 |
| 6. Osgood Rd/BART St<br>Irvington             | --<br>--                       |     | A (0.45)<br>A (0.50)  |     | 229<br>217             | 16.5<br>12.5 | No                 |
| <i>Warm Springs</i>                           |                                |     |                       |     |                        |              |                    |
| 1. Osgood Rd/<br>Durham Rd                    | E (0.96)<br>D (0.87)           |     | E (0.97)<br>E (0.94)  |     | 93<br>84               | 1.5<br>1.5   | Yes                |
| 2. I-680 SB Ramps/<br>Durham Rd               | D (0.86)<br>A (0.50)           |     | D (0.88)<br>A (0.51)  |     | 79<br>72               | 1.9<br>2.1   | Yes                |
| 3. I-680 NB Ramps/<br>Durham Rd               | D (0.88)<br>D (0.81)           |     | E (0.91)<br>D (0.84)  |     | 53<br>62               | 2.0<br>2.4   | Yes                |
| 4. S. Grimmer Bl/Osgood<br>Rd-Warm Springs Bl | B (0.62)<br>A (0.46)           |     | B (0.67)<br>A (0.50)  |     | 231<br>210             | 8.3<br>8.2   | No                 |
| 5. Fremont Bl/<br>S. Grimmer Bl               | A (0.59)<br>A (0.45)           |     | A (0.60)<br>A (0.47)  |     | 59<br>54               | 2.2<br>2.3   | No                 |
| 6. Fremont Bl/<br>I-880 NB Ramps              | C (0.71)<br>A (0.42)           |     | C (0.71)<br>A (0.42)  |     | 53<br>48               | 1.3<br>1.3   | No                 |
| 7. Fremont Blvd/Cushing<br>Rd-I-880 SB Ramps  | F (1.09)<br>C (0.77)           |     | F (1.09)<br>C (0.77)  |     | 25<br>34               | 0.4<br>0.6   | Yes                |
| 8. Mohave Dr/<br>Mission Bl                   | D (0.83)<br>D (0.87)           |     | D (0.90)<br>E (0.91)  |     | 334<br>304             | 5.3<br>5.3   | Yes                |
| 9. Warm Springs Bl/BART<br>St W.S. North      | --<br>--                       |     | C (0.79)<br>A (0.46)  |     | 496<br>313             | 17.0<br>17.3 | No                 |
| 10. Warm Springs Bl/<br>BART St W.S. South    | --<br>--                       |     | B (0.67)<br>A (0.52)  |     | 516<br>469             | 17.6<br>23.9 | No                 |
| 11. Warm Springs Bl/<br>Mission Bl            | E (0.95)<br>C (0.77)           |     | E (0.96)<br>D (0.88)  |     | 426<br>388             | 5.3<br>5.8   | Yes                |

Notes: For each intersection, LOS and V/C ratio is shown as AM peak hour on top of PM peak hour. Unsignalized one- and two-way stop controlled intersections are shown as the worst movement from the minor street followed by the worst movement from the major street (e.g. D/A). Unsignalized all-way stop controlled intersections are shown as either better than LOS C (<C) or worse than LOS C (>C).

Level of impact assumes implementation of improvements planned by City of Fremont or Milpitas.

\*BART generated traffic as a percent of total volume at intersection.

Source: DKS Associates, 1991.



**Table 3.12-10 (cont.)**

**Summary of Intersection Traffic Analysis Results - Proposed Project  
Year 2010 (Cumulative Impacts)**

| Intersection                                        | W/out Proposed Project |     | With Proposed Project |     | BART-Generated Traffic |          | Significant Impact |
|-----------------------------------------------------|------------------------|-----|-----------------------|-----|------------------------|----------|--------------------|
|                                                     | LOS                    | V/C | LOS                   | V/C | Amount                 | Percent* |                    |
| <i>South Warm Springs</i>                           |                        |     |                       |     |                        |          |                    |
| 1. Milmont Dr/<br>Kato Rd                           | C (0.71)               |     | D (0.82)              |     | 326                    | 12.9     | No                 |
|                                                     | A (0.59)               |     | C (0.79)              |     | 296                    | 13.0     |                    |
| 2. Warm Springs Bl/<br>Kato Rd/Scott Creek Rd       | E (0.91)               |     | E (0.94)              |     | 200                    | 3.9      | Yes                |
|                                                     | C (0.72)               |     | C (0.77)              |     | 182                    | 4.7      |                    |
| 3. I-680 SB Ramps/<br>Scott Creek Rd                | A (0.35)               |     | A (0.37)              |     | 110                    | 5.1      | No                 |
|                                                     | A (0.45)               |     | A (0.45)              |     | 100                    | 3.8      |                    |
| 4. I-680 NB Ramps/<br>Scott Creek Rd                | A/A                    |     | A/A                   |     | 85                     | 5.4      | No                 |
|                                                     | A/A                    |     | A/A                   |     | 38                     | 2.5      |                    |
| 5. N. Milpitas Bl/<br>Dixon Landing Rd              | F (1.01)               |     | F (1.01)              |     | 84                     | 2.3      | Yes                |
|                                                     | D (0.88)               |     | D (0.90)              |     | 76                     | 2.2      |                    |
| 6. Milmont Dr/<br>Dixon Landing Rd                  | F (1.02)               |     | F (1.22)              |     | 321                    | 9.0      | Yes                |
|                                                     | E (0.97)               |     | F (1.05)              |     | 292                    | 8.1      |                    |
| 7. I-880 NB Ramps-California<br>Cr/Dixon Landing Rd | E (0.96)               |     | F (1.12)              |     | 321                    | 5.9      | Yes                |
|                                                     | C (0.78)               |     | C (0.78)              |     | 292                    | 6.7      |                    |
| 8. I-880 SB Ramps/<br>Dixon Landing Rd              | A (0.60)               |     | A (0.60)              |     | 72                     | 2.0      | No                 |
|                                                     | A (0.49)               |     | A (0.49)              |     | 193                    | 4.8      |                    |
| 9. Warm Springs Rd/BART<br>St S.W.S. North          | --                     |     | A (0.51)              |     | 9                      | 0.3      | No                 |
|                                                     | --                     |     | A (0.52)              |     | 8                      | 0.3      |                    |
| 10. Warm Springs Rd/<br>BART St S.W.S. SE           | --                     |     | A (0.58)              |     | 156                    | 5.4      | No                 |
|                                                     | --                     |     | B (0.61)              |     | 143                    | 5.7      |                    |
| 11. Kato Rd/BART St<br>S.W.S. South                 | --                     |     | C (0.78)              |     | 373                    | 18.6     | No                 |
|                                                     | --                     |     | A (0.46)              |     | 339                    | 23.8     |                    |

Notes: For each intersection, LOS and V/C ratio is shown as AM peak hour on top of PM peak hour. Unsignalized one- and two-way stop controlled intersections are shown as the worst movement from the minor street followed by the worst movement from the major street (e.g. D/A). Unsignalized all-way stop controlled intersections are shown as either better than LOS C (<C) or worse than LOS C (>C).

Level of impact assumes implementation of improvements planned by City of Fremont or Milpitas.

\*BART generated traffic as a percent of total volume at intersection.

Source: DKS Associates, 1991.

### 3.12 Transportation

- Mohave Drive/Mission Boulevard would have an evening peak hour V/C ratio of 0.91 (LOS E) with the Proposed Project, and 0.87 (LOS D) without it. The proposed BART extension would contribute 5.3 percent of the total traffic volumes at this intersection.
- Warm Springs Boulevard/Mission Boulevard would operate at mid LOS E with or without the Proposed Project in the morning peak hour. About 5.3 percent of the total traffic volumes at this intersection would be related to the Proposed Project.
- Warm Springs Boulevard/Kato Road-Scott Creek Road would operate at LOS E in the morning peak hour with or without the BART extension. The Proposed Project would contribute 3.9 percent to the total traffic volumes during this time.
- North Milpitas Boulevard-Warm Springs Boulevard/Dixon Landing Road would have a projected morning V/C ratio of 1.01 with or without the BART extension. About 2.3 percent of the total traffic volumes at this intersection would be due to the Proposed Project.
- Milmont Drive/Dixon Landing Road would have a V/C ratio of 1.02 without the Proposed Project, and 1.22 with the Proposed Project in the morning peak hour. The proposed BART extension would contribute 9.0 percent to the total traffic volumes at this intersection.
- I-880 Northbound Ramps/California Circle would operate at LOS F (V/C =- 1.12) with the Proposed Project, contributing 5.9 percent to the total intersection traffic volumes in the A.M. peak hour. The intersection would operate at LOS E without the Proposed Project.

**Parking.** Parking demand was estimated by using the adjusted MTC forecasts of auto access (which is exclusively work-related travel), divided by the auto occupancy factor for work trips, which is 1.05. Table 3.12-11 shows the estimated parking demand for the long term cumulative scenario (year 2010), along with the number of spaces included in the station concept plans. These demand figures include the demand generated by other transit bus service from the South Warm Springs Station.

**Table 3.12-11  
Adequacy of Parking Supply  
Proposed Project**

|                                       | Irvington<br>Station | Warm Springs<br>Station | South Warm<br>Springs Station |
|---------------------------------------|----------------------|-------------------------|-------------------------------|
| Estimated Year 2010<br>Parking Demand | 760                  | 1,370                   | 1,390 <sup>1</sup>            |
| Approximate Number of Stalls          | 1,200                | 2,100                   | 2,400                         |

<sup>1</sup>Includes parking demand for transportation serving other than BART.

Source: DKS Associates, July 1991

Note: Parking supply estimates are based on station concept drawings. As the stations are designed, the actual parking supply could change. BART plans to meet, as a minimum, the year 2010 parking demand.

The parking supply at the Irvington, Warm Springs and South Warm Springs Stations is 1,200, 2,100 and 2,400 spaces, respectively. There would be adequate parking to meet demand at each of the three proposed stations. The Proposed Project would have no significant long term cumulative impact on parking.

### Construction Period Impacts

Impacts during construction of the proposed BART Warm Springs extension period will include the following, all of which are potentially significant short term impacts. :

- Temporary detours on Walnut Avenue and Washington Boulevard.
- Elimination of parking on the west side of Osgood Road along the frontage of the proposed Irvington Station site.
- Traffic due to construction workers driving to the construction sites.

- Movement of heavy equipment to and from the sites.
- Potential temporary lane closures to work on aerial structures.

### **Mitigation Measures**

Mitigation measures for impacts identified in the impacts analysis for 1998 and year 2010 are presented below.

**Mitigation of Intersection Capacity Problems.** Mitigation measures to alleviate intersection capacity deficiencies were evaluated for project impacts at year 1998 and 2010 (cumulative) levels. Improvements include roadway widening and provision of additional turn lanes on intersection approaches and installation of traffic signals. City of Fremont and Milpitas plans were considered when determining appropriate intersection mitigation measures. In general, the following procedure was followed when considering specific measures:

- Since project impacts at 1998 levels were considered *without* assuming implementation of Fremont plans, the effect of implementing the City planned improvements was tested. In most cases, this was adequate to mitigate project impacts. If it was not adequate, further improvements were considered, if feasible.
- For the cumulative analysis (year 2010), impacts were assessed assuming Fremont plans were already implemented. Many planned traffic improvements in Fremont are to be funded by a traffic impact fee program now under consideration by the City. Additional mitigation measures were proposed when deemed both necessary and feasible.

Tables 3.12-12 and 3.12-13 summarize the proposed mitigation measures and their effect on relieving traffic congestion in the vicinity of the proposed extension stations for 1998 and 2010, respectively. The tables show the assumed level of impact and the level of service after mitigation. Specifics on the proposed mitigation measures are included in Appendix D.

Table 3.12-12

Summary of Intersection Impacts, Mitigation Measures & Residual Impacts -- Proposed Project Year 1998

|                           | Effect with Proposed Project                   | Effect of Mitigation       | Residual Significant Impact       | Northbound |                   |        |        |           |          | Southbound |         |        |         |         |        | Number of Lanes |         |        |        |            |        | Comments |
|---------------------------|------------------------------------------------|----------------------------|-----------------------------------|------------|-------------------|--------|--------|-----------|----------|------------|---------|--------|---------|---------|--------|-----------------|---------|--------|--------|------------|--------|----------|
|                           |                                                |                            |                                   | L          | T                 | R      | L      | T         | R        | L          | T       | R      | L       | T       | R      | L               | T       | R      | L      | T          | R      |          |
| <b>Irvington</b>          |                                                |                            |                                   |            |                   |        |        |           |          |            |         |        |         |         |        |                 |         |        |        |            |        |          |
| 2.                        | Driscoll Rd-Osgood Washington Bl               | AM F (1.39)<br>PM F (1.09) | C (0.74)<br>E (0.95) <sup>1</sup> | Yes        | Existing Improved | 1<br>1 | 1<br>3 | 0<br>1    | 1<br>1   | 1<br>2     | 1<br>1  | 1<br>1 | 1<br>1  | 1<br>2  | 1<br>1 | 0<br>1*         | 0<br>1* | 1<br>2 | 1<br>2 | 1<br>2     | 1<br>1 | a,b      |
| <b>Warm Springs</b>       |                                                |                            |                                   |            |                   |        |        |           |          |            |         |        |         |         |        |                 |         |        |        |            |        |          |
| 4.                        | S. Grimmer Bl/Osgood Rd-Warm Springs Bl        | >C<br>>C                   | A (0.56)<br>A (0.52)              | No         |                   | 1<br>1 | 2<br>1 | 0<br>1    | 1<br>1   | 2<br>1     | 1<br>1  | 1<br>1 | 1<br>1  | 1<br>2  | 1<br>1 | 1<br>1*         | 1<br>1* | 2<br>1 | 2<br>1 | 2<br>1     | 1<br>1 | a,b      |
| 6.                        | Fremont Bl/<br>I-880 NB Ramps                  | E (0.93)<br>D (0.81)       | A (0.32)<br>A (0.31)              | No         |                   | 0<br>0 | 1<br>0 | 0<br>0    | 1<br>0   | 1<br>1*    | 1<br>1* | 0<br>0 | 0<br>0  | 0<br>0  | 0<br>0 | 0<br>0          | 0<br>0  | 0<br>0 | 0<br>0 | 1<br>0     | 1<br>0 | a        |
| 7.                        | Fremont Blvd/Cushing Rd-I-880 SB Ramps         | >C<br>>C                   | D (0.83)<br>A (0.36)              | No         |                   | 0<br>2 | 1<br>3 | 1<br>1    | 0<br>1   | 1<br>3     | 1<br>1  | 1<br>2 | 1<br>2  | 1<br>2  | 1<br>1 | 0<br>1          | 0<br>1  | 1<br>2 | 1<br>1 | 1<br>1     | 1<br>1 | a,b      |
| 8.                        | Mohave Dr/<br>Mission Bl                       | D (0.84)<br>F (1.30)       | C (0.79) <sup>2</sup><br>E (0.94) | Yes        |                   | 1<br>1 | 1<br>1 | 1<br>1    | 1<br>1   | 1<br>1     | 1<br>1  | 1<br>1 | 1<br>1  | 1<br>4  | 1<br>1 | 1<br>1          | 1<br>1  | 2<br>4 | 3<br>4 | 0<br>0     | 0<br>0 | b        |
| 11.                       | Warm Springs Bl/<br>Mission Bl                 | E (0.97)<br>F (1.02)       | D (0.87) <sup>2</sup><br>E (0.98) | Yes        |                   | 2<br>2 | 2<br>3 | 1<br>1    | 2<br>2   | 2<br>3     | 1<br>1  | 2<br>2 | 3<br>4  | 3<br>4  | 1<br>1 | 1<br>1          | 1<br>1  | 2<br>4 | 3<br>4 | 3<br>1     | 1<br>1 | b        |
| <b>South Warm Springs</b> |                                                |                            |                                   |            |                   |        |        |           |          |            |         |        |         |         |        |                 |         |        |        |            |        |          |
| 1.                        | Milmont Dr/<br>Kato Rd                         | F/E<br>F/B                 | C (0.77)<br>B (0.65)              | No         |                   | 0<br>1 | 0<br>0 | 0<br>0    | 1<br>2** | 0<br>0     | 0<br>1  | 0<br>1 | 0<br>1  | 2<br>1  | 0<br>1 | 0<br>1          | 0<br>1  | 2<br>1 | 2<br>1 | 0<br>1     | 1<br>1 | a,b      |
| 2.                        | Warm Springs Bl/<br>Kato Rd-Scott Creek Rd     | C (0.77)<br>D (0.87)       | C (0.73)<br>D (0.84)              | No         |                   | 2<br>2 | 3<br>3 | 0<br>0    | 2<br>3   | 0<br>0     | 1<br>1  | 3<br>3 | 0<br>0  | 3<br>3  | 0<br>0 | 0<br>0          | 0<br>0  | 3<br>3 | 0<br>0 | 2**<br>2** | 1<br>1 | c,d      |
| 3.                        | I-680 SB Ramps/<br>Scott Creek Road            | E/A<br>D/A                 | A (0.49)<br>A (0.28)              | No         |                   | 0<br>0 | 0<br>0 | 0<br>0    | 1<br>0   | 1**<br>1*  | 0<br>0  | 0<br>0 | 1<br>1* | 2<br>1* | 1<br>1 | 1**<br>1*       | 1<br>1  | 2<br>1 | 2<br>0 | 2<br>0     | 0<br>0 | a,b      |
| 5.                        | N. Milpitas Bl/<br>Dixon Landing Rd            | E (0.94)<br>D (0.88)       | D (0.81)<br>C (0.77)              | No         |                   | 1<br>2 | 2<br>0 | 1**<br>0  | 2<br>2   | 0<br>1     | 2<br>1  | 1<br>1 | 2<br>2  | 0<br>0  | 1<br>1 | 0<br>0          | 0<br>0  | 2<br>2 | 0<br>0 | 1<br>2     | 0<br>0 |          |
| 6.                        | Milmont Drive/<br>Dixon Landing Rd             | F (1.28)<br>B (0.69)       | C (0.76)<br>A (0.44)              | No         |                   | 0<br>1 | 0<br>1 | 0<br>0    | 1<br>1   | 0<br>1*    | 1<br>1  | 1<br>1 | 1<br>2  | 1<br>2  | 1<br>1 | 1<br>1          | 1<br>1  | 2<br>1 | 2<br>1 | 2<br>1     | 2<br>1 |          |
| 7.                        | I-880 NB Ramps-California Cr./Dixon Landing Rd | F (1.32)<br>E (0.94)       | B (0.70)<br>A (0.56)              | No         |                   | 1<br>1 | 1<br>1 | 0**<br>1* | 1<br>1   | 1<br>1     | 1<br>1  | 1<br>1 | 1<br>1  | 1<br>2  | 1<br>1 | 1<br>1*         | 1<br>1* | 2<br>2 | 1<br>2 | 1<br>2     | 1<br>1 |          |

Note: For each intersection, LOS and V/C ratio is given for AM peak hour over PM peak hour. Lane configurations are existing geometrics over improved geometrics.

1 Construction of Blacow undercrossing would reduce impact to insignificant.  
 2 Construction of I-880 - I-680 connector would reduce level of impact.

Guide to comments:

- a Mitigation includes installation of traffic signal.
- b Mitigation implements City of Fremont or Milpitas plans.
- c Mitigation is more than planned by City of Fremont or Milpitas.
- d Existing reflects implementation of improvements planned for 1991.
- \* = Free right turn where exclusive turn lane has an exclusive receiving lane, allowing free flow traffic without yielding.
- \*\* = One through lane is a shared right turn lane.

Source: DKS Associates, 1991

Table 3.12-13

Summary of Intersection Mitigation Measures & Residual Impacts -- Proposed Project Year 2010 - Cumulative

| Location                                    | Impact with Proposed Project | Impact of Mitigation | Residual Significant Impact | Number of Lanes |   |    |            |   |    |           |   |   |           |   |    | Comments                       |                                |   |   |
|---------------------------------------------|------------------------------|----------------------|-----------------------------|-----------------|---|----|------------|---|----|-----------|---|---|-----------|---|----|--------------------------------|--------------------------------|---|---|
|                                             |                              |                      |                             | Northbound      |   |    | Southbound |   |    | Eastbound |   |   | Westbound |   |    |                                |                                |   |   |
|                                             |                              |                      |                             | L               | T | R  | L          | T | R  | L         | T | R | L         | T | R  |                                |                                |   |   |
| <b>Irvington</b>                            |                              |                      |                             |                 |   |    |            |   |    |           |   |   |           |   |    |                                |                                |   |   |
| 1. Union/Fremont/ Bay - Washington          | AM F (1.03)<br>PM F (1.05)   | 4                    | Yes                         | 0               | 2 | 1* | 0          | 1 | 0  | 1         | 0 | 1 | 1         | 0 | 2  | 0                              | None Feasible<br>None Feasible |   |   |
| 2. Driscoll Rd-Osgood Washington BI         | B (0.66)<br>C (0.80)         | NA                   | No                          | 1               | 1 | 0  | 1          | 1 | 1  | 1         | 1 | 2 | 1*        | 1 | 2  | 1                              | None Feasible<br>None Feasible |   | b |
| 3. I-680/SB Ramps/ Washington BI            | E/D<br>E/F                   | NA                   | Yes                         | 0               | 0 | 0  | 1          | 0 | 1* | 1         | 2 | 0 | 0         | 2 | 1* | None Feasible<br>None Feasible |                                | c |   |
| 4. I-680 NB Ramps-Lazon/ Washington BI      | C (0.76)<br>C (0.74)         | NA                   | No                          | 1               | 1 | 1  | 1          | 1 | 1  | 1         | 1 | 1 | 1         | 2 | 1  | None Feasible<br>None Feasible |                                | b |   |
| 5. Osgood Rd/Blacow Rd                      | A (0.55)<br>A (0.58)         | NA                   | No                          | 0               | 2 | 0  | 0          | 2 | 0  | 0         | 0 | 0 | 0*        | 0 | 0  | 0                              | None Feasible<br>None Feasible |   | b |
| <b>Warm Springs</b>                         |                              |                      |                             |                 |   |    |            |   |    |           |   |   |           |   |    |                                |                                |   |   |
| 1. Osgood Rd/ Durham Rd                     | E (0.97)<br>E (0.94)         | C (0.76)<br>C (0.75) | No                          | 1               | 1 | 1  | 1          | 2 | 1  | 1         | 1 | 2 | 1         | 1 | 2  | 0                              | None Feasible<br>None Feasible |   | c |
| 2. I-680 SB Ramps/ Durham Rd                | D (0.88)<br>A (0.51)         | NA                   | Yes                         | 2               | 0 | 1  | 0          | 0 | 0  | 0         | 0 | 2 | 1*        | 1 | 2  | 0                              | None Feasible<br>None Feasible |   | d |
| 3. I-680 NB Ramps/ Durham Rd                | E (0.91)<br>D (0.84)         | D (0.82)<br>B (0.70) | No                          | 2               | 1 | 1  | 1          | 1 | 1  | 1         | 1 | 2 | 1*        | 1 | 2  | 0                              | None Feasible<br>None Feasible |   | c |
| 4. S. Grimer BI/Osgood Rd - Warm Springs BI | B (0.67)<br>A (0.05)         | NA                   | No                          | 1               | 1 | 0  | 1          | 1 | 1  | 1         | 1 | 1 | 1         | 1 | 2  | 1                              | None Feasible<br>None Feasible |   | b |
| 6. Fremont BI/ I-880 NB Ramps               | C (0.71)<br>A (0.42)         | NA                   | No                          | 0               | 1 | 0  | 0          | 1 | 1* | 0         | 0 | 0 | 0         | 1 | 0  | 1*                             | None Feasible<br>None Feasible |   | b |
| 7. Fremont BI/Cushing Rd - I-880 SB Ramps   | F (1.09)<br>C (0.77)         | NA                   | Yes                         | 0               | 1 | 1  | 0          | 1 | 1  | 1         | 1 | 1 | 0         | 1 | 1  | 1                              | None Feasible<br>None Feasible |   | b |

Note: For each intersection, LOS and V/C ratio is given for AM peak hour over PM peak hour. Lane configurations are existing geometrics over planned geometrics (by Fremont or Milpitas) over additional improvements.

1 Impact with proposed project assumes implementation of City of Fremont or Milpitas improvement plans. See Appendix D for details of mitigation measures at intersections for the proposed project and all alternatives.

Guide to comments:

a Mitigation includes installation of traffic signal. b Mitigation implements City of Fremont or Milpitas plans. c Mitigation is more than planned by City of Fremont or Milpitas. d Impact slightly exceeds City of Fremont goal of 0.85 V/C ratio; additional mitigation not recommended. e Additional mitigation not feasible.

\* = Free right turn where exclusive turn lane has an exclusive receiving lane, allowing free flow traffic without yielding. \*\* = One through lane is a shared left turn lane.

Source: DKS Associates, 1991

Table 3.12-13 (continued)

Summary of Intersection Mitigation Measures & Residual Impacts -- Proposed Project Year 2010 - Cumulative

| Item                          | Impact with Proposed Project                      | Impact of Mitigation | Residual Significant Impact | Northbound                        |                       | Southbound            |                       |                       | Eastbound             |                         |                       | Westbound             |                       |   | Comments |
|-------------------------------|---------------------------------------------------|----------------------|-----------------------------|-----------------------------------|-----------------------|-----------------------|-----------------------|-----------------------|-----------------------|-------------------------|-----------------------|-----------------------|-----------------------|---|----------|
|                               |                                                   |                      |                             | L T R                             |                       | L T R                 |                       |                       | L T R                 |                         |                       | L T R                 |                       |   |          |
|                               |                                                   |                      |                             | L                                 | T                     | R                     | L                     | T                     | R                     | L                       | T                     | R                     | L                     | T |          |
| <i>Warm Springs continued</i> |                                                   |                      |                             |                                   |                       |                       |                       |                       |                       |                         |                       |                       |                       |   |          |
| 8.                            | AM D (0.90)<br>PM E (0.91)                        | NA                   | Yes                         | 1<br>1<br>None Feasible           | 1<br>1<br>1           | 1<br>1<br>1           | 1<br>1<br>1           | 1<br>2<br>1           | 2<br>4<br>1           | 1<br>4<br>1             | 1<br>2<br>4           | 3<br>4<br>0           | 0<br>0<br>0           | b |          |
| 11.                           | Warm Springs BI/<br>Mission BI                    | NA                   | Yes                         | 2<br>2<br>None Feasible           | 2<br>3<br>1           | 2<br>3<br>1           | 2<br>3<br>1           | 2<br>2<br>2           | 3<br>4<br>1           | 3<br>4<br>1             | 2<br>2<br>2           | 3<br>4<br>1           | 1<br>1<br>1           | e |          |
| <i>South Warm Springs</i>     |                                                   |                      |                             |                                   |                       |                       |                       |                       |                       |                         |                       |                       |                       |   |          |
| 1.                            | Milmont Dr/<br>Kato Rd                            | NA                   | No                          | 0<br>1<br>None Required           | 0<br>2<br>0           | 1<br>2<br>0           | 0<br>1<br>1           | 0<br>1<br>1           | 2<br>1<br>1           | 0<br>1<br>1             | 0<br>1<br>1           | 2<br>1<br>1           | 0<br>1<br>1           | b |          |
| 2.                            | Warm Springs BI/<br>Kato Rd - Scott Creek         | D (0.94)<br>C (0.80) | No                          | 1<br>2<br>3<br>3<br>None Required | 2<br>3<br>0<br>2<br>3 | 0<br>0<br>0<br>0<br>0 | 1<br>3<br>0<br>1<br>1 | 1<br>3<br>0<br>1<br>1 | 1<br>3<br>0<br>0<br>0 | 1<br>3<br>0<br>1<br>2** | 1<br>1<br>1<br>2<br>2 | 1<br>2<br>2<br>2<br>2 | 1<br>1<br>1<br>1<br>1 | c |          |
| 3.                            | I-680 SB Ramps/<br>Scott Creek Rd                 | NA                   | No                          | 0<br>0<br>None Required           | 0<br>0<br>0           | 0<br>0<br>1           | 0<br>0<br>1           | 0<br>1<br>1           | 0<br>1<br>1           | 0<br>2<br>1             | 1<br>1<br>1           | 2<br>2<br>2           | 0<br>0<br>0           | a |          |
| 5.                            | N. Milpitas BI/<br>Dixon Landing Rd               | F (1.04)<br>E (0.90) | No                          | 1<br>1<br>2<br>2<br>None Required | 2<br>2<br>0<br>2<br>0 | 2<br>2<br>0<br>1<br>1 | 1<br>2<br>1<br>1<br>1 | 1<br>2<br>1<br>1<br>1 | 2<br>3<br>0<br>3<br>2 | 0<br>0<br>0<br>0<br>0   | 1<br>1<br>3<br>3<br>1 | 1<br>1<br>3<br>3<br>1 | 2<br>3<br>0<br>0<br>0 | c |          |
| 6.                            | Milmont Drive/<br>Dixon Landing Rd                | F (1.22)<br>F (1.05) | No                          | 0<br>1<br>1<br>1<br>None Required | 0<br>1<br>1<br>1<br>1 | 0<br>1<br>1<br>1<br>1 | 1<br>0<br>0<br>0<br>1 | 1<br>1<br>1<br>1<br>1 | 1<br>1<br>1<br>1<br>1 | 0<br>0<br>0<br>0<br>0   | 1<br>1<br>1<br>1<br>2 | 2<br>0<br>0<br>0<br>1 | 3<br>0<br>0<br>0<br>3 | e |          |
| 7.                            | I-880 NB Ramps-California<br>Cr./Dixon Landing Rd | F (1.12)<br>C (0.78) | No                          | 1<br>1<br>1<br>1<br>None Required | 1<br>1<br>1<br>1<br>1 | 1<br>1<br>1<br>1<br>1 | 1<br>1<br>1<br>1<br>1 | 1<br>1<br>1<br>1<br>1 | 1<br>1<br>1<br>1<br>1 | 1<br>1<br>1<br>1<br>1   | 1<br>1<br>1<br>1<br>1 | 1<br>1<br>1<br>1<br>1 | 1<br>1<br>1<br>1<br>1 | e |          |
| 8.                            | I-880 SB Ramps/<br>Dixon Landing Rd               | B (0.60)<br>A (0.49) | No                          | 0<br>0<br>None Required           | 0<br>0<br>0           | 0<br>0<br>0           | 0<br>0<br>1           | 0<br>0<br>1           | 0<br>0<br>1           | 0<br>0<br>1             | 0<br>0<br>3           | 1<br>1<br>1           | 3<br>1<br>1           | b |          |

Note: For each intersection, LOS and V/C ratio is given for AM peak hour over PM peak hour.

1 Impact with proposed project assumes implementation of City of Fremont or Milpitas improvement plans. See Appendix D for details of mitigation measures at intersections for the proposed project and all alternatives.

Guide to comments:

<sup>a</sup> Mitigation includes installation of traffic signal. <sup>b</sup> Mitigation implements City of Fremont or Milpitas plans. <sup>c</sup> Mitigation is more than planned by City of Fremont or Milpitas. <sup>d</sup> Impact slightly exceeds City of Fremont goal of 0.85 V/C ratio; additional mitigation not recommended. <sup>e</sup> Additional mitigation not feasible.

\* = Free right turn where exclusive turn lane has an exclusive receiving lane, allowing free flow traffic without yielding. \*\* = One through lane is a shared right turn lane.

Source: DKS Associates, July 1991.

### 3.12 Transportation

The following mitigation measures are proposed to alleviate traffic congestion for the opening year (1998) in the vicinity of the extension stations:

- At Driscoll Road-Osgood Road/Washington Boulevard, implement the City of Fremont's planned improvements which include adding two thru-lanes and one right-turn lane on the northbound approach, one thru-lane on the southbound approach, one thru-lane and a free-flow right-turn lane on the eastbound approach. There would be a residual impact after mitigation. However, implementation of the Blacow undercrossing would reduce the impact to insignificant.
- At South Grimmer Boulevard/Osgood Road-Warm Springs Boulevard, implement the City of Fremont's planned improvements which involve signalization, and roadway improvements. These improvements include adding one thru-lane on the northbound, southbound and eastbound approaches, a right-turn lane on the northbound approach; free-flow right turns would be provided on the eastbound approach. There would be no residual impact.
- At Fremont Boulevard/I-880 Northbound Ramps, partially implement the City's planned improvements, which are to signalize and reconfigure the interchange to a partial cloverleaf configuration. There would be no residual impact.
- At Fremont Boulevard/Cushing Road-I-880 Southbound Ramps, implement the City's improvements by signalizing and widening on all approaches. There would be no residual impact.
- At Mohave Drive/Mission Boulevard, implement the City's planned improvements, which are to widen Mission Boulevard to four lanes in each direction, and provide dual left-turn lanes on the westbound approach. This mitigation would still result in LOS E during the evening peak hour, although the residual impact could be eliminated by construction of the I-680 to I-880 connector freeway.
- At Warm Springs Boulevard/Mission Boulevard, implement the City's planned improvements by widening Mission Boulevard to four lanes in each direction. This would leave the LOS in the P.M. peak hour at high E ( $V/C = 0.98$ ). Construction of the I-680 to I-880 connector freeway would eliminate this impact.



### 3.12 Transportation

- At Milmont Drive/Kato Road, implement the City's planned improvements which are to signalize the intersection, and widen the northbound and southbound approaches to two thru-lanes, and one left-turn lane.
- At Warm Springs Boulevard/Kato Road - Scott Creek Road, the City's planned improvements would not be adequate to mitigate conditions. An additional mitigation measure which would reduce the cumulative impact to less than significant would be to restripe one of the thru-lanes on the westbound approach, making it a shared right-turn lane; this would result in no residual impact.
- At I-680 Southbound Ramps/Scott Creek Road, the improvements planned by the City of Fremont involve signalization. There would be no residual impact after this mitigation.
- At North Milpitas Boulevard/Dixon Landing Road, the mitigation would be to restripe the northbound approach to provide a second left-turn lane, while removing the right-turn lane. There would be no residual impact.
- At Milmont Drive/Dixon Landing Road, improvements would involve providing additional turning lanes on the southbound and westbound approaches. There would be no residual impact.
- At I-880 Northbound Ramps-California Circle/Dixon Landing Road, the improvements would include an additional thru-lane on the eastbound and westbound approaches, and a northbound-to-eastbound free flowing right turn. There would be no residual impact after mitigation.

The following improvements would be needed to mitigate cumulative (year 2010) traffic conditions in the vicinity of the extension stations. For some intersections, the improvements will mitigation the impact to a less than significant level. For other intersections, there is no additional feasible mitigation which would reduce the impact to a less than significant level; these intersections are also discussed under residual impacts.

- At Union-Fremont/Washington-Bay, no mitigation beyond what was recently constructed at this intersection would be feasible. There would be a residual impact at this intersection with or without the Proposed Project; the V/C ratio would be 1.03 in the A.M. peak hour, and 1.05 in the P.M. peak hour.

### 3.12 Transportation

- At Driscoll Road-Osgood Road/Washington Boulevard, the implementation of City of Fremont plans at this intersection results in acceptable service levels. There is no residual impact after mitigation.
- At I-680 Southbound Ramps/Washington Boulevard, the southbound-to-eastbound left turn movement would have a LOS F. A test of peak hour signal warrants at this intersection indicates that a signal would not be warranted due to low traffic on the side street. It is therefore recommended that no additional mitigation be provided here, leaving the residual impact for the left turn movement at LOS F.
- At I-680 Northbound Ramps-Luzon/Washington Boulevard, implementation of the City's planned improvements would result in an acceptable LOS with no residual impact. The improvement involves the addition of a second left-turn lane on the southbound and eastbound approaches.
- At Osgood Road/Blacow Road, the City's planned improvement is to connect Blacow Road between Osgood Road and Roberts Avenue by crossing under the railroad tracks and the proposed BART extension tracks. The intersection of Osgood Road and Blacow Road would have two thru-lanes in each direction on Osgood Road, plus a left-turn lane on each approach. Improvements at this intersection would be adequate under cumulative conditions.
- At Osgood Road/Durham Road, the City's planned improvements would not be adequate to meet cumulative traffic needs. A second left-turn lane on the southbound approach would provide acceptable service levels.
- At I-680 Southbound Ramps/Durham Road the improvements planned by the City involve widening Durham Road to three thru-lanes in each direction, and making the northbound approach a free right-turn movement. The resultant V/C ratio in the A.M. peak hour would be 0.88 (LOS D), which is slightly over the City of Fremont's goal. No additional mitigation is recommended.
- At I-680 Northbound Ramps/Durham Road, the City's planned improvement (making the eastbound-to-southbound right-turn movement free flowing) would not be adequate. Providing a second left-turn lane on the eastbound approach would result in no residual impact.

### 3.12 Transportation

- At South Grimmer Boulevard/Osgood Road-Warm Springs Boulevard, the City plans to widen Osgood Road and Warm Springs Boulevard to two lanes in each direction, providing an eastbound-to-southbound free flowing right-turn; this would result in LOS A in the P.M. peak hour, and LOS B in the A.M. peak hour.
- At Fremont Boulevard/I-880 Northbound Ramps, implement the City's plans to widen Fremont Boulevard to three lanes in each direction, and provide a southbound-to-westbound double left-turn lane as part of the partial cloverleaf interchange; this would result in no residual impact.
- At Fremont Boulevard/Cushing Road - I-880 Southbound Ramps, the City's planned improvements involve widening Fremont Boulevard to three through-lanes in each direction, a double left-turn lane on the northbound and eastbound approaches, and a free flowing right-turn lane on the southbound approach; implementation of these improvements would still result in LOS F. No further mitigations would be feasible at this location, and the residual impact would be significant.
- At Mohave Drive/Mission Boulevard, the City's planned improvements involve widening Mission Boulevard to four through-lanes in each direction, and providing a westbound-to-southbound double left-turn lane. These improvements would result in an A.M. peak hour V/C ratio of 0.90, and a P.M. peak hour V/C ratio of 0.91. No additional mitigation would be feasible at this location; the residual impact would be significant.
- At Warm Springs Boulevard/Mission Boulevard, the improvements planned by the City would still result in a residual impact (LOS E in the A.M. peak hour). The improvements involve widening Mission Boulevard to four through-lanes in each direction, and adding a through-lane on the northbound approach. No additional improvements would be feasible at this location; the residual impact would be significant.
- At Milmont Drive/Kato Road, the City's improvements would be adequate to mitigate future traffic conditions with no residual impact. The improvements involve installing a traffic signal, and adding one or two lanes on all approaches.
- At Warm Springs Boulevard/Scott Creek Road-Kato Road, the City of Fremont's improvement plans would not be adequate to relieve traffic conditions. The

improvements involve dual left-turn lanes on the northbound and southbound approaches, three through-lanes on the northbound and southbound approaches, and three through-lanes on the eastbound approach. The plan could be enhanced by restriping one of the westbound thru-lanes as a shared thru-lane and right-turn lane. There would still be a residual impact after this mitigation ( $V/C = 0.94$  in A.M. peak).

- At I-680 Southbound Ramps/Scott Creek Road, the City's planned improvements involve signalization and a second thru-lane on the eastbound approach; with this mitigation, no residual impact would occur.
- At North Milpitas Boulevard/Dixon Landing Road, the City of Milpitas has plans to widen Dixon Landing Road to three thru-lanes in each direction. This improvement alone would not be adequate to serve future traffic flows. A second left-turn lane on the northbound approach would result in LOS D conditions at this intersection, with no residual impact.
- At Milmont Drive/Dixon Landing Road, the City of Milpitas has plans to widen Dixon Landing Road to three thru-lanes in each direction. This improvement alone would result in LOS F conditions in both morning and evening peak hours. An alternative plan would be to convert one of the eastbound thru-lanes to a second left-turn lane, and to add a free flowing right-turn lane on the southbound approach; this would result in no residual impact.
- At I-880 Northbound Ramps-California Circle/Dixon Landing Road, the City of Milpitas' plans, which call for two thru-lanes in each direction on Dixon Landing Road, would not be adequate. An additional free flowing right-turn lane on the northbound approach would result in no residual impact.
- At I-880 Southbound Ramps/Dixon Landing Road, the City of Milpitas has plans to provide three thru-lanes in each direction on Dixon Landing Road, an eastbound-to-southbound free flowing right-turn lane, and two southbound-to-eastbound left-turn lanes; implementation of these improvements would result in no residual impact.

**Mitigation of Pedestrian Access Problems.** Roberts Avenue has discontinuous sidewalks to the south and west of the Irvington station. Continuous sidewalks should be installed prior to opening the Irvington Station.

Planned roadway improvements in the vicinity of the Irvington Station (on Osgood and Driscoll Roads) and Warm Springs Station (Warm Springs Boulevard and South Grimmer Boulevard) would include sidewalks. Should these improvements not be completed by developers by the time the stations open, adequate pedestrian walkways should be provided.

At the South Warm Springs Station, the railroad tracks west of the project could pose a barrier to pedestrians travelling from the industrial parks which are just west of the station. A pedestrian overpass going from the station site across the tracks to the Milmont Drive area could alleviate this barrier, and encourage ridership.

**Mitigation of Bicycle Access Problems.** Roadway widenings planned in the vicinity of the Irvington Station (Osgood Road, Driscoll Road) should have adequate width for bicycles. At the Warm Springs Station, roads are to be widened with room for bike lanes. If these roadways are not widened by developers in time for the station opening, adequate pedestrian walkways should be provided.

Washington Boulevard between Fremont Boulevard and the Irvington Station site is expected to see considerable increase in traffic with little opportunity for widening, which could effect bicycle access from that direction. This could be mitigated by the connection of Blacow Road between Roberts Avenue and Osgood Road, a City of Fremont planned improvement. This planned undercrossing of the railroad tracks should incorporate enough width to account for bicycle access and safety issues by providing adequate lighting and a separated path to reduce bicycle/automobile conflicts. This design feature should also consider potential bicycle/pedestrian conflicts.

**Construction Period Mitigations.** Mitigation measures associated with construction period impacts are:

- **Temporary Detours on Walnut Avenue and Washington Boulevard.** This should be mitigated by maintaining the same number of lanes as currently on these roads, by keeping the duration of detour to a minimum, and by adequately signing and marking the detours.
- **Construction Worker Traffic.** Workers should be encouraged to car pool and take transit.

- **Movement of Heavy Equipment to and From the Sites.** Movement of such equipment should be scheduled for non-peak travel times.
- **Temporary Lane Closures Due to Work on Aerial Structures.** These should be schedule for non-peak travel times.

It is likely that some impact due to construction would remain during the construction period.

#### **Residual Impacts After Mitigation**

The following residual transportation impacts are expected to remain after mitigation:

**Capacity-Related Impacts.** The following intersections would not be mitigated to better than City of Fremont level of service objectives (Refer also to Tables 3.12-12 and 3.12-13):

- **In 1998:**
  - Driscoll Road-Osgood Road/Washington Boulevard (construction of Blacow undercrossing would fully mitigate this impact)
  - Mohave Drive/Mission Boulevard (construction of I-880 to I-680 connector would reduce level of impact)
  - Warm Springs Boulevard/Mission Boulevard (Construction of I-880 to I-680 connector would reduce level of impact)
- **In 2010:**
  - I-680 Southbound Ramps/Washington Boulevard (volume too low to warrant a traffic signal)
  - I-680 Southbound Ramps/Durham Road (only slightly above City of Fremont objectives).
  - Fremont Boulevard/Cushing Road-I-880 Southbound Ramp (no feasible improvement)

- Mohave Drive/Mission Boulevard (no feasible improvement)
- Warm Springs Boulevard/Mission Boulevard (no feasible improvement)

**Construction Period Impacts.** The impact due to construction cannot be completely eliminated. These would, however, be temporary impacts.

#### **3.12.4 IMPACTS OF DESIGN OPTIONS**

There would be little difference in transportation impacts among the design options. In the Paseo Padre design option where Paseo Padre Parkway is elevated over BART and the railroad tracks, there would be benefits to auto circulation.

#### **3.12.5 IMPACTS OF ALTERNATIVE 1 - No Project and No Transportation Improvements**

From a regional perspective, this alternative would have the highest amount of vehicle miles of travel (VMT) per day, 105,955,000 miles in year 2010. It is over 20 percent greater than existing conditions (see discussion in Section 3.12.13). This would translate to higher congestion levels on regional facilities than in the any of the other alternatives.

Additional congestion could also be expected on a local level, as regional facilities become more congested. Taking no action could be expected to have potentially significant effects on regional transportation.

#### **3.12.6 IMPACTS OF ALTERNATIVE 2 - No Project, Programmed Transportation Improvements**

Regionwide VMT is estimated to be about 104,557,000 miles in year 2010 and would be approximately 19 percent increase over existing condition (see discussion in Section 3.12.13). This would lead to higher congestion levels on regional facilities than all other alternatives except Alternative 1.

As with Alternative 1, additional congestion could also be expected on a local level, as regional facilities become more congested. This could be expected to have a potentially significant effect on regional transportation.

### 3.12.7 IMPACTS OF ALTERNATIVE 3 - Transportation Systems Management (TSM) Improvements

From the perspective of regional travel by automobile, this alternative shows about 17.5 percent increase in VMT over existing conditions. However, this alternative is a marked improvement over either Alternative 1 or Alternative 2 (see discussion in Sections 3.12.13). This would result in an improvement over the No Project alternatives, but it is likely that congestion would remain in the extension corridor. The overall impact is beneficial, but conditions would still be congested.

### 3.12.8 IMPACTS OF ALTERNATIVES 4 AND 5

The difference in alignment between Alternatives 4 and 5 is expected to have no effect on the level of transportation impacts. They are therefore discussed together.

#### Direct Impacts

**Station Traffic Impacts Analysis.** The methodology of the station traffic impact analysis is the same as used for the Proposed Project presented in subsection 3.12.2. Table 3.12-14 shows the results of the patronage analysis from the perspective of automobile traffic generation at each of the proposed stations for existing conditions, year 1998 and year 2010. Tables 3.12-15 and 3.12-16 show the intersection analysis results for 1991 and 1998 under Alternatives 4 and 5.

**Table 3.12-14**  
**Estimated Peak Hour Auto Trip Generation**  
**New BART Station(s), Alternatives 4 & 5**

|             | Irvington<br>---- Station ---- |            |            | Warm Springs<br>---- Station ---- |            |            |
|-------------|--------------------------------|------------|------------|-----------------------------------|------------|------------|
|             | 1991                           | 1998       | 2010       | 1991                              | 1998       | 2010       |
| AM Inbound  | 231                            | 251        | 283        | 510                               | 566        | 667        |
| AM Outbound | <u>61</u>                      | <u>66</u>  | <u>74</u>  | <u>134</u>                        | <u>149</u> | <u>175</u> |
| AM TOTAL    | 292                            | 317        | 357        | 644                               | 715        | 842        |
| PM Inbound  | 88                             | 95         | 108        | 194                               | 215        | 253        |
| PM Outbound | <u>178</u>                     | <u>193</u> | <u>218</u> | <u>392</u>                        | <u>436</u> | <u>513</u> |
| PM TOTAL    | 266                            | 288        | 326        | 586                               | 651        | 766        |

Source: DKS Associates, 1991



**Table 3.12-15**  
**Summary of Intersection Traffic Analysis Results**  
**Existing<sup>1</sup> Plus Alternatives 4 or 5**

| Intersection                                  | W/out Proposed Project |          | With Proposed Project |     | BART-Generated Traffic |                      | Significant Impact |
|-----------------------------------------------|------------------------|----------|-----------------------|-----|------------------------|----------------------|--------------------|
|                                               | LOS                    | V/C      | LOS                   | V/C | Amount                 | Percent <sup>2</sup> |                    |
| <i>Irvington</i>                              |                        |          |                       |     |                        |                      |                    |
| 1. Fremont Bl/Bay St/<br>Washington Bl        | A.M.                   | B (0.62) | B (0.63)              |     | 38                     | 1.9                  | No                 |
|                                               | P.M.                   | B (0.66) | B (0.67)              |     | 34                     | 1.3                  |                    |
| 2. Driscoll Rd-Osgood Rd/<br>Washington Bl    | D (0.83)               |          | F (1.19)              |     | 111                    | 3.6                  | Yes                |
|                                               | C (0.78)               |          | F (1.01)              |     | 100                    | 3.0                  |                    |
| 3. I-680 SB Ramps/<br>Washington Bl           | D/A                    |          | E/A                   |     | 32                     | 2.2                  | No                 |
|                                               | E/B                    |          | E/B                   |     | 29                     | 1.8                  |                    |
| 4. I-680 NB Ramps-Luzon/<br>Washington Bl     | A (0.45)               |          | A (0.52)              |     | 31                     | 2.0                  | No                 |
|                                               | A (0.49)               |          | A (0.58)              |     | 28                     | 1.6                  |                    |
| 5. Osgood Rd/Blacow Rd                        | --                     |          | A (0.47)              |     | 180                    | 13.2                 | No                 |
|                                               | --                     |          | A (0.31)              |     | 164                    | 9.3                  |                    |
| 6. Osgood Rd/BART St<br>Irvington             | --                     |          | A (0.43)              |     | 182                    | 13.3                 | No                 |
|                                               | --                     |          | A (0.34)              |     | 171                    | 16.1                 |                    |
| <i>Warm Springs</i>                           |                        |          |                       |     |                        |                      |                    |
| 1. Osgood Rd/<br>Durham Rd                    | C (0.74)               |          | C (0.75)              |     | 64                     | 1.7                  | No                 |
|                                               | C (0.77)               |          | C (0.80)              |     | 59                     | 1.6                  |                    |
| 2. I-680 SB Ramps/<br>Durham Rd               | A (0.55)               |          | A (0.56)              |     | 52                     | 1.4                  | No                 |
|                                               | A (0.51)               |          | A (0.52)              |     | 47                     | 1.7                  |                    |
| 3. I-680 NB Ramps/<br>Durham Rd               | A (0.44)               |          | A (0.45)              |     | 41                     | 2.5                  | No                 |
|                                               | A (0.36)               |          | A (0.38)              |     | 43                     | 2.5                  |                    |
| 4. S. Grimmer Bl/Osgood<br>Rd-Warm Springs Bl | >C                     |          | >C                    |     | 200                    | 8.5                  | Yes                |
|                                               | >C                     |          | >C                    |     | 182                    | 10.0                 |                    |
| 5. Fremont Bl/<br>S. Grimmer Bl               | A (0.42)               |          | A (0.44)              |     | 103                    | 5.2                  | No                 |
|                                               | A (0.38)               |          | A (0.40)              |     | 94                     | 5.2                  |                    |
| 6. Fremont Bl/<br>I-880 NB Ramps              | F/A                    |          | F/A                   |     | 97                     | 6.3                  | Yes                |
|                                               | D/A                    |          | E/A                   |     | 88                     | 5.2                  |                    |
| 7. Fremont Blvd/Cushing<br>Rd-I-880 SB Ramps  | >C                     |          | >C                    |     | 34                     | 1.7                  | Yes                |
|                                               | >C                     |          | >C                    |     | 61                     | 5.0                  |                    |
| 8. Mohave Dr/<br>Mission Bl                   | B (0.67)               |          | C (0.79)              |     | 203                    | 4.8                  | Yes                |
|                                               | E (0.95)               |          | F (1.08)              |     | 185                    | 3.9                  |                    |
| 9. Warm Springs Bl/BART<br>St W.S. North      | --                     |          | A (0.60)              |     | 361                    | 16.2                 | No                 |
|                                               | --                     |          | A (0.57)              |     | 245                    | 11.5                 |                    |
| 10. Warm Springs Bl/<br>BART St W.S. South    | --                     |          | B (0.64)              |     | 502                    | 21.2                 | No                 |
|                                               | --                     |          | B (0.68)              |     | 457                    | 19.6                 |                    |
| 11. Warm Springs Bl/<br>Mission Bl            | D (0.82)               |          | C (0.80)              |     | 441                    | 7.3                  | Yes                |
|                                               | D (0.85)               |          | E (0.98)              |     | 401                    | 5.3                  |                    |

Note: For each intersection, LOS and V/C ratio shown as A.M. peak hour on top of PM peak hour. Unsignalized one- and two-way stop controlled intersections are shown as the worst moment for the minor street followed by the worst moment for the major street (e.g. D/A). Unsignalized all-way stop controlled intersections are shown as either better than LOS C (<C) or worse than LOS C (>C).

<sup>1</sup>Existing conditions are based on conditions from 1988-1990.

<sup>2</sup>BART generated traffic as a percent of total approach volume at intersection.

Source: DKS Associates, 1991.

**Table 3.12-16**

**Summary of Intersection Traffic Analysis Results - Alternative 4 or 5  
Year 1998**

| Intersection                                  | W/out Proposed Project |          | With Proposed Project |     | BART-Generated Traffic |          | Significant Impact |
|-----------------------------------------------|------------------------|----------|-----------------------|-----|------------------------|----------|--------------------|
|                                               | LOS                    | V/C      | LOS                   | V/C | Amount                 | Percent* |                    |
| <i>Irvington</i>                              |                        |          |                       |     |                        |          |                    |
| 1. Fremont Bl/Bay St/<br>Washington Bl        | A.M.                   | B (0.64) | B (0.67)              |     | 226                    | 10.7     | No                 |
|                                               | P.M.                   | D (0.81) | D (0.83)              |     | 204                    | 6.8      |                    |
| 2. Driscoll Rd-Osgood Rd/<br>Washington Bl    |                        | F (1.23) | F (1.39)              |     | 305                    | 8.6      | Yes                |
|                                               |                        | E (0.95) | F (1.04)              |     | 276                    | 7.3      |                    |
| 3. I-680 SB Ramps/<br>Washington Bl           |                        | E/A      | E/B                   |     | 35                     | 2.2      | No                 |
|                                               |                        | E/C      | E/C                   |     | 32                     | 1.8      |                    |
| 4. I-680 NB Ramps-Luzon/<br>Washington Bl     |                        | A (0.55) | A (0.55)              |     | 33                     | 1.9      | No                 |
|                                               |                        | B (0.62) | B (0.63)              |     | 30                     | 1.6      |                    |
| 5. Osgood Rd/Blacow Rd                        |                        | A (0.41) | A (0.41)              |     | 13                     | 1.0      | No                 |
|                                               |                        | A (0.29) | A (0.29)              |     | 12                     | 1.2      |                    |
| 6. Osgood Rd/BART St<br>Irvington             |                        | -        | A (0.44)              |     | 296                    | 18.6     | No                 |
|                                               |                        | -        | A (0.41)              |     | 224                    | 18.8     |                    |
| <i>Warm Springs</i>                           |                        |          |                       |     |                        |          |                    |
| 1. Osgood Rd/<br>Durham Rd                    |                        | C (0.79) | C (0.79)              |     | 72                     | 1.6      | No                 |
|                                               |                        | D (0.85) | D (0.85)              |     | 65                     | 1.5      |                    |
| 2. I-680 SB Ramps/<br>Durham Rd               |                        | B (0.64) | B (0.65)              |     | 57                     | 1.3      | No                 |
|                                               |                        | A (0.59) | B (0.61)              |     | 52                     | 1.5      |                    |
| 3. I-680 NB Ramps/<br>Durham Rd               |                        | A (0.51) | A (0.52)              |     | 46                     | 2.4      | No                 |
|                                               |                        | A (0.42) | A (0.44)              |     | 48                     | 2.3      |                    |
| 4. S. Grimmer Bl/Osgood<br>Rd-Warm Springs Bl |                        | >C       | >C                    |     | 222                    | 7.9      | Yes                |
|                                               |                        | >C       | >C                    |     | 202                    | 9.3      |                    |
| 5. Fremont Bl/<br>S. Grimmer Bl               |                        | A (0.49) | A (0.50)              |     | 114                    | 4.8      | No                 |
|                                               |                        | A (0.44) | A (0.46)              |     | 104                    | 4.8      |                    |
| 6. Fremont Bl/<br>I-880 NB Ramps              |                        | F/A      | F/A                   |     | 107                    | 5.8      | Yes                |
|                                               |                        | E/B      | E/C                   |     | 98                     | 4.9      |                    |
| 7. Fremont Blvd/Cushing<br>Rd-I-880 SB Ramps  |                        | >C       | >C                    |     | 38                     | 1.6      | Yes                |
|                                               |                        | >C       | >C                    |     | 67                     | 4.6      |                    |
| 8. Mohave Dr/<br>Mission Bl                   |                        | C (0.80) | D (0.84)              |     | 225                    | 4.5      | Yes                |
|                                               |                        | F (1.25) | F (1.29)              |     | 205                    | 3.6      |                    |
| 9. Warm Springs Bl/BART<br>St W.S. North      |                        | -        | B (0.69)              |     | 401                    | 15.2     | No                 |
|                                               |                        | -        | B (0.65)              |     | 272                    | 10.8     |                    |
| 10. Warm Springs Bl/<br>BART St W.S. South    |                        | -        | C (0.74)              |     | 558                    | 20.0     | No                 |
|                                               |                        | -        | D (0.81)              |     | 508                    | 18.4     |                    |
| 11. Warm Springs Bl/<br>Mission Bl            |                        | E (0.96) | F (1.03)              |     | 490                    | 6.8      | Yes                |
|                                               |                        | F (1.02) | F (1.07)              |     | 446                    | 4.9      |                    |

Note: For each intersection, LOS and V/C ratio is shown as AM peak hour on top of PM peak hour. Unsignalized one- and two-way stop controlled intersections are shown as the worst movement from the minor street followed by the worst movement from the major street (e.g. D/A). Unsignalized all-way stop controlled intersections are shown as either better than LOS C (<C) or worse than LOS C (>C).

\*BART generated traffic as a percent of total volume at intersection.

Source: DKS Associates, 1991.

Traffic impacts with Alternatives 4 and 5 would be essentially the same as the Proposed Project, except in the vicinity of the South Warm Springs Station where there would be no impact.

**Pedestrian and Bicycle Access Routes.** Impacts in the vicinity of the stations would be similar as for the Proposed Project, except for the South Warm Springs Station area where the ease of pedestrian and bicycle circulation would be irrelevant to the BART project.

**Parking.** The proposed parking lots in the station concepts are sized to meet the year 2010 parking demand, discussed under cumulative impacts in this section. The parking demand under existing conditions and year 1998 will be less than the parking supply and there will be no significant impact on parking.

**Transit.** The impact of Alternatives 4 and 5 on transit service are similar to the Proposed Project. The only difference would be that SCCTD buses would need to travel an additional 2.4 miles to reach the connection with BART at Warm Springs Station. The buses would, however, have 5.4 fewer miles to travel than to the existing Fremont Station. This is a beneficial impact when compared to alternatives with no Warm Springs extension.

**Freight Railroad Operations.** The impacts would be similar to the Proposed Project.

#### **Cumulative Impacts**

The cumulative impact analysis was based on growth forecasts from the Fremont General Plan.

**Station Traffic Impact Analysis.** Alternatives 4 and 5 would have significant impacts at the same intersections as those significantly effected by the Proposed Project in the vicinity of the proposed Irvington and Warm Springs Stations. There would be beneficial impacts in the vicinity of the Fremont Station, and no impact in the vicinity of the South Warm Springs Station. Table 3.12-17 shows the intersection analysis results for the year 2010 with Alternatives 4 and 5.

**Parking.** Parking demand was estimated in the same way as for the Proposed Project. Table 3.12-18 shows estimated parking demand versus the amount to be provided by BART at the station site. The proposed Warm Springs Station would have more parking available in this alternative than that in the Proposed Project. Parking supply would be adequate to meet the parking demand at both extension stations and no significant impacts would occur.

**Table 3.12-17**  
**Summary of Intersection Traffic Analysis Results - Alternatives 4 or 5**  
**Year 2010**

| Intersection                                  | W/out Proposed Project         |     | With Proposed Project |     | BART-Generated Traffic |              | Significant Impact |
|-----------------------------------------------|--------------------------------|-----|-----------------------|-----|------------------------|--------------|--------------------|
|                                               | LOS                            | V/C | LOS                   | V/C | Amount                 | Percent*     |                    |
| <i>Irvington</i>                              |                                |     |                       |     |                        |              |                    |
| 1. Fremont Bl/Bay St/<br>Washington Bl        | A.M. F (1.03)<br>P.M. F (1.05) |     | F (1.03)<br>F (1.06)  |     | 46<br>43               | 1.2<br>1.0   | Yes                |
| 2. Driscoll Rd-Osgood Rd/<br>Washington Bl    | B (0.60)<br>C (0.78)           |     | B (0.66)<br>C (0.80)  |     | 136<br>124             | 3.8<br>3.0   | No                 |
| 3. I-680 SB Ramps/<br>Washington Bl           | E/D<br>F/F                     |     | E/D<br>F/F            |     | 39<br>36               | 1.4<br>1.2   | Yes                |
| 4. I-680 NB Ramps-Luzon/<br>Washington Bl     | C (0.74)<br>C (0.74)           |     | C (0.76)<br>C (0.74)  |     | 37<br>34               | 1.5<br>1.2   | No                 |
| 5. Osgood Rd/Blacow Rd                        | A (0.45)<br>A (0.54)           |     | A (0.55)<br>A (0.57)  |     | 221<br>203             | 9.4<br>8.8   | No                 |
| 6. Osgood Rd/BART St<br>Irvington             | --<br>--                       |     | A (0.45)<br>A (0.50)  |     | 223<br>212             | 16.1<br>12.3 | No                 |
| <i>Warm Springs</i>                           |                                |     |                       |     |                        |              |                    |
| 1. Osgood Rd/<br>Durham Rd                    | E (0.96)<br>D (0.87)           |     | E (0.97)<br>E (0.93)  |     | 84<br>77               | 1.4<br>1.4   | Yes                |
| 2. I-680 SB Ramps/<br>Durham Rd               | D (0.86)<br>A (0.50)           |     | D (0.87)<br>A (0.51)  |     | 67<br>61               | 1.6<br>1.8   | Yes                |
| 3. I-680 NB Ramps/<br>Durham Rd               | D (0.88)<br>D (0.81)           |     | E (0.91)<br>D (0.83)  |     | 54<br>56               | 2.1<br>2.1   | Yes                |
| 4. S. Grimmer Bl/Osgood<br>Rd-Warm Springs Bl | B (0.62)<br>A (0.46)           |     | B (0.66)<br>A (0.52)  |     | 261<br>237             | 9.3<br>9.2   | No                 |
| 5. Fremont Bl/<br>S. Grimmer Bl               | A (0.59)<br>A (0.45)           |     | B (0.61)<br>A (0.49)  |     | 135<br>123             | 4.8<br>5.0   | No                 |
| 6. Fremont Bl/<br>I-880 NB Ramps              | C (0.71)<br>A (0.42)           |     | C (0.71)<br>A (0.43)  |     | 126<br>115             | 3.0<br>2.9   | No                 |
| 7. Fremont Blvd/Cushing<br>Rd-I-880 SB Ramps  | F (1.09)<br>C (0.77)           |     | F (1.09)<br>C (0.77)  |     | 45<br>79               | 0.7<br>1.4   | Yes                |
| 8. Mohave Dr/<br>Mission Bl                   | D (0.83)<br>D (0.87)           |     | D (0.90)<br>E (0.91)  |     | 265<br>241             | 4.2<br>4.3   | Yes                |
| 9. Warm Springs Bl/BART<br>St W.S. North      | --<br>--                       |     | C (0.77)<br>A (0.46)  |     | 472<br>320             | 16.4<br>17.6 | No                 |
| 10. Warm Springs Bl/<br>BART St W.S. South    | --<br>--                       |     | D (0.82)<br>B (0.61)  |     | 657<br>597             | 21.4<br>28.5 | No                 |
| 11. Warm Springs Bl/<br>Mission Bl            | E (0.95)<br>C (0.77)           |     | F (1.01)<br>D (0.86)  |     | 577<br>525             | 7.1<br>7.7   | Yes                |

Notes: For each intersection, LOS and V/C ratio is shown as AM peak hour on top of PM peak hour. Unsignalized one- and two-way stop controlled intersections are shown as the worst movement from the minor street followed by the worst movement from the major street (e.g. D/A). Unsignalized all-way stop controlled intersections are shown as either better than LOS C (<C) or worse than LOS C (>C).

Level of impact assumes implementation of improvements planned by City of Fremont or Milpitas.

\*BART generated traffic as a percent of total volume at intersection.

Source: DKS Associates, 1991.

**Table 3.12-18  
Adequacy of Parking Supply  
Alternatives 4 or 5**

|                                       | Irvington<br>Station | Warm Springs<br>Station |
|---------------------------------------|----------------------|-------------------------|
| Estimated Year 2010<br>Parking Demand | 740                  | 2,300 <sup>1</sup>      |
| Approximate Number of Stalls          | 1,200                | 2,300                   |

<sup>1</sup>Includes parking demand for transportation services other than BART.

Source: DKS Associates, 1991.

Note: Parking supply estimates are based on station concept drawings. As the stations are designed, the actual parking supply could change. BART plans to meet, as a minimum, the year 2010 parking demand.

### Construction Period Impacts

Impacts are similar as for the Proposed Project, except that the area south of Warm Springs Station is not affected.

### Mitigation Measures

Mitigation measures in the vicinity of Irvington and Warm Springs Stations are the same as for the Proposed Project.

### Residual Impacts After Mitigation

Residual impacts after mitigation are the same as the Proposed Project, except there would be none in the vicinity of the South Warm Springs Station.

### 3.12.9 IMPACTS OF ALTERNATIVES 6, 7 AND 8

The difference in alignment between Alternatives 6, 7 and 8 is expected to have no effect on the level of transportation impacts. They are therefore discussed together.

#### Direct Impacts

**Station Traffic Impacts Analysis.** The methodology for the station traffic impact analysis is the same as used for the Proposed Project presented in Section 3.12-2. Table 3.12-19 shows the results of the patronage analysis from the perspective of automobile traffic generation at each of the proposed stations for existing conditions, year 1998 and year 2010. Table 3.12-20 and Table 3.12-21 show the intersection analysis results for 1991 and 1998 under Alternatives 6, 7 and 8.

Impacts for Alternatives 6, 7 and 8 would be essentially the same as the Proposed Project, except at the Osgood Road/Durham Road intersection in 1998 where the V/C ratio would be 0.01 greater than the threshold of 0.85. There would be no impact in the vicinity of Irvington Station.

**Table 3.12-19**  
**Estimated Peak Hour Auto Trip Generation**  
**New BART Station(s), Alternatives 6, 7 or 8**

|             | Warm Springs<br>---- Station ---- |            |            | South Warm Springs<br>---- Station ---- |            |            |
|-------------|-----------------------------------|------------|------------|-----------------------------------------|------------|------------|
|             | 1991                              | 1998       | 2010       | 1991                                    | 1998       | 2010       |
| AM Inbound  | 403                               | 451        | 536        | 359                                     | 386        | 435        |
| AM Outbound | <u>106</u>                        | <u>119</u> | <u>141</u> | <u>94</u>                               | <u>101</u> | <u>114</u> |
| AM TOTAL    | 509                               | 570        | 677        | 453                                     | 487        | 549        |
| PM Inbound  | 153                               | 171        | 204        | 136                                     | 146        | 165        |
| PM Outbound | <u>310</u>                        | <u>347</u> | <u>412</u> | <u>276</u>                              | <u>297</u> | <u>334</u> |
| PM TOTAL    | 463                               | 518        | 616        | 412                                     | 443        | 499        |

Source: DKS Associates, 1991.

**Table 3.12-20**  
**Summary of Intersection Traffic Analysis Results**  
**Existing<sup>1</sup> Plus Alternatives 6, 7 or 8**

| Intersection                                  | W/out Proposed Project |          | With Proposed Project |     | BART-Generated Traffic |                      | Significant Impact |
|-----------------------------------------------|------------------------|----------|-----------------------|-----|------------------------|----------------------|--------------------|
|                                               | LOS                    | V/C      | LOS                   | V/C | Amount                 | Percent <sup>2</sup> |                    |
| <i>Warm Springs</i>                           |                        |          |                       |     |                        |                      |                    |
| 1. Osgood Rd/<br>Durham Rd                    | A.M.                   | C (0.74) | C (0.75)              |     | 71                     | 1.8                  | No                 |
|                                               | P.M.                   | C (0.77) | D (0.81)              |     | 65                     | 1.8                  |                    |
| 2. I-680 SB Ramps/<br>Durham Rd               |                        | A (0.55) | A (0.55)              |     | 31                     | 0.9                  | No                 |
|                                               |                        | A (0.51) | A (0.52)              |     | 28                     | 1.0                  |                    |
| 3. I-680 NB Ramps/<br>Durham Rd               |                        | A (0.44) | A (0.45)              |     | 22                     | 1.4                  | No                 |
|                                               |                        | A (0.36) | A (0.38)              |     | 25                     | 1.4                  |                    |
| 4. S. Grimmer Bl/Osgood<br>Rd-Warm Springs Bl |                        | >C       | >C                    |     | 163                    | 7.1                  | Yes                |
|                                               |                        | >C       | >C                    |     | 148                    | 8.3                  |                    |
| 5. Fremont Bl/<br>S. Grimmer Bl               |                        | A (0.42) | A (0.43)              |     | 61                     | 3.2                  | No                 |
|                                               |                        | A (0.38) | A (0.38)              |     | 56                     | 3.1                  |                    |
| 6. Fremont Bl/<br>I-880 NB Ramps              |                        | F/A      | F/A                   |     | 36                     | 2.4                  | Yes                |
|                                               |                        | D/A      | E/A                   |     | 32                     | 2.0                  |                    |
| 7. Fremont Blvd/Cushing<br>Rd-I-880 SB Ramps  |                        | >C       | >C                    |     | 18                     | 0.9                  | Yes                |
|                                               |                        | >C       | >C                    |     | 23                     | 2.0                  |                    |
| 8. Mohave Dr/<br>Mission Bl                   |                        | B (0.67) | C (0.79)              |     | 277                    | 6.5                  | Yes                |
|                                               |                        | E (0.95) | F (1.09)              |     | 252                    | 5.2                  |                    |
| 9. Warm Springs Bl/BART<br>St W.S. North      |                        | --       | B (0.63)              |     | 383                    | 17.0                 | No                 |
|                                               |                        | --       | A (0.55)              |     | 233                    | 11.0                 |                    |
| 10. Warm Springs Bl/<br>BART St W.S. South    |                        | --       | A (0.55)              |     | 402                    | 17.7                 | No                 |
|                                               |                        | --       | B (0.65)              |     | 366                    | 16.3                 |                    |
| 11. Warm Springs Bl/<br>Mission Bl            |                        | D (0.82) | C (0.75)              |     | 344                    | 5.8                  | Yes                |
|                                               |                        | D (0.85) | E (0.91)              |     | 313                    | 4.2                  |                    |
| <i>South Warm Springs</i>                     |                        |          |                       |     |                        |                      |                    |
| 1. Milmont Dr/<br>Kato Rd                     |                        | F/C      | E/D                   |     | 286                    | 14.9                 | Yes                |
|                                               |                        | F/A      | F/A                   |     | 260                    | 18.7                 |                    |
| 2. Warm Springs Bl/<br>Kato Rd/Scott Creek Rd |                        | B (0.65) | D (0.81)              |     | 168                    | 5.3                  | Yes                |
|                                               |                        | E (0.97) | E (0.99)              |     | 152                    | 4.5                  |                    |
| 3. I-680 SB Ramps/<br>Scott Creek Rd          |                        | D/A      | D/A                   |     | 95                     | 4.8                  | No                 |
|                                               |                        | C/A      | C/A                   |     | 87                     | 4.6                  |                    |

Note: For each intersection, LOS and V/C ratio shown as A.M. peak hour on top of PM peak hour. Unsignalized one- and two-way stop controlled intersections are shown as the worst moment for the minor street followed by the worst moment for the major street (e.g. D/A). Unsignalized all-way stop controlled intersections are shown as either better than LOS C (<C) or worse than LOS C (>C).

<sup>1</sup>Existing conditions are based on conditions from 1988-1990.

<sup>2</sup>BART generated traffic as a percent of total approach volume at intersection.

Source: DKS Associates, 1991.

**Table 3.12-20 (cont.)**  
**Summary of Intersection Traffic Analysis Results**  
**Existing<sup>1</sup> Plus Alternatives 6, 7 or 8**

| Intersection                                        | W/out Proposed Project |     | With Proposed Project |     | BART-Generated Traffic |                      | Significant Impact |
|-----------------------------------------------------|------------------------|-----|-----------------------|-----|------------------------|----------------------|--------------------|
|                                                     | LOS                    | V/C | LOS                   | V/C | Amount                 | Percent <sup>2</sup> |                    |
| <i>South Warm Springs cont'd</i>                    |                        |     |                       |     |                        |                      |                    |
| 4. I-680 NB Ramps/<br>Scott Creek Rd                | A/A                    |     | A/A                   |     | 74                     | 5.5                  | No                 |
|                                                     | A/A                    |     | A/A                   |     | 33                     | 3.0                  |                    |
| 5. N. Milpitas Bl/<br>Dixon Landing Rd              | C (0.80)               |     | D (0.81)              |     | 68                     | 2.5                  | No                 |
|                                                     | B (0.66)               |     | C (0.71)              |     | 62                     | 2.2                  |                    |
| 6. Milmont Dr/<br>Dixon Landing Rd                  | D (0.85)               |     | F (1.09)              |     | 281                    | 10.5                 | Yes                |
|                                                     | A (0.44)               |     | B (0.61)              |     | 255                    | 12.2                 |                    |
| 7. I-880 NB Ramps-California<br>Cr/Dixon Landing Rd | E (0.96)               |     | F (1.13)              |     | 281                    | 9.9                  | Yes                |
|                                                     | C (0.77)               |     | D (0.84)              |     | 255                    | 10.3                 |                    |
| 8. I-880 SB Ramps/<br>Dixon Landing Rd              | A/A                    |     | A/A                   |     | 62                     | 4.0                  | No                 |
|                                                     | A/A                    |     | A/A                   |     | 169                    | 13.3                 |                    |
| 9. Warm Springs Rd/BART<br>St S.W.S. North          | --                     |     | A (0.47)              |     | 8                      | 0.4                  | No                 |
|                                                     | --                     |     | A (0.39)              |     | 7                      | 0.4                  |                    |
| 10. Warm Springs Rd/<br>BART St S.W.S. SE           | --                     |     | A (0.54)              |     | 132                    | 6.2                  | No                 |
|                                                     | --                     |     | A (0.44)              |     | 121                    | 5.8                  |                    |
| 11. Kato Rd/BART St<br>S.W.S. South                 | --                     |     | A (0.46)              |     | 325                    | 27.0                 | No                 |
|                                                     | --                     |     | A (0.32)              |     | 295                    | 57.5                 |                    |

Note: For each intersection, LOS and V/C ratio shown as A.M. peak hour on top of PM peak hour. Unsignalized one- and two-way stop can controlled intersections are shown as the worst moment for the minor street followed by the worst moment for the major street (e.g. D/A). Unsignalized all-way stop controlled intersections are shown as either better than LOS C (<C) or worse than LOS C (>C).

<sup>1</sup>Existing conditions are based on conditions from 1988-1990.

<sup>2</sup>BART generated traffic as a percent of total approach volume at intersection.

Source: DKS Associates, 1991.



**Table 3.12-21**  
**Summary of Intersection Traffic Analysis Results - Alternatives 6, 7 or 8**  
**Year 1998**

| Intersection                                  | W/out Proposed Project |          | With Proposed Project |        | BART-Generated Traffic |          | Significant Impact |
|-----------------------------------------------|------------------------|----------|-----------------------|--------|------------------------|----------|--------------------|
|                                               | LOS                    | V/C      | LOS                   | V/C    | Amount                 | Percent* |                    |
| <i>Warm Springs</i>                           |                        |          |                       |        |                        |          |                    |
| 1. Osgood Rd/<br>Durham Rd                    | A.M.                   | C (0.79) | C                     | (0.79) | 80                     | 1.7      | Yes                |
|                                               | P.M.                   | D (0.85) | D                     | (0.86) | 73                     | 1.7      |                    |
| 2. I-680 SB Ramps/<br>Durham Rd               |                        | B (0.64) | B                     | (0.64) | 34                     | 0.8      | No                 |
|                                               |                        | A (0.59) | A                     | (0.60) | 31                     | 0.9      |                    |
| 3. I-680 NB Ramps/<br>Durham Rd               |                        | A (0.51) | A                     | (0.52) | 25                     | 1.3      | No                 |
|                                               |                        | A (0.42) | A                     | (0.43) | 28                     | 1.3      |                    |
| 4. S. Grimmer Bl/Osgood<br>Rd-Warm Springs Bl |                        | >C       | >C                    |        | 182                    | 6.6      | Yes                |
|                                               |                        | >C       | >C                    |        | 166                    | 7.8      |                    |
| 5. Fremont Bl/<br>S. Grimmer Bl               |                        | A (0.49) | A                     | (0.50) | 68                     | 2.9      | No                 |
|                                               |                        | A (0.44) | A                     | (0.44) | 62                     | 2.9      |                    |
| 6. Fremont Bl/<br>I-880 NB Ramps              |                        | F/A      | F/A                   |        | 40                     | 2.2      | Yes                |
|                                               |                        | E/B      | E/B                   |        | 36                     | 1.9      |                    |
| 7. Fremont Blvd/Cushing<br>Rd-I-880 SB Ramps  |                        | >C       | >C                    |        | 21                     | 0.9      | Yes                |
|                                               |                        | >C       | >C                    |        | 26                     | 1.8      |                    |
| 8. Mohave Dr/<br>Mission Bl                   |                        | C (0.80) | D                     | (0.84) | 311                    | 6.1      | Yes                |
|                                               |                        | F (1.25) | F                     | (1.30) | 282                    | 4.9      |                    |
| 9. Warm Springs Bl/BART<br>St W.S. North      |                        | --       | C                     | (0.72) | 429                    | 16.1     | No                 |
|                                               |                        | --       | B                     | (0.64) | 261                    | 10.4     |                    |
| 10. Warm Springs Bl/<br>BART St W.S. South    |                        | --       | B                     | (0.63) | 450                    | 16.7     | No                 |
|                                               |                        | --       | C                     | (0.76) | 409                    | 15.4     |                    |
| 11. Warm Springs Bl/<br>Mission Bl            |                        | E (0.96) | E                     | (0.97) | 385                    | 5.4      | Yes                |
|                                               |                        | F (1.02) | F                     | (1.02) | 350                    | 3.9      |                    |
| <i>South Warm Springs</i>                     |                        |          |                       |        |                        |          |                    |
| 1. Milmont Dr/<br>Kato Rd                     |                        | F/D      | F/E                   |        | 307                    | 13.5     | Yes                |
|                                               |                        | F/A      | F/B                   |        | 280                    | 17.1     |                    |
| 2. Warm Springs Bl/<br>Kato Rd/Scott Creek Rd |                        | C (0.71) | C                     | (0.77) | 181                    | 4.8      | Yes                |
|                                               |                        | D (0.82) | D                     | (0.87) | 164                    | 4.1      |                    |
| 3. I-680 SB Ramps/<br>Scott Creek Rd          |                        | E/A      | E/A                   |        | 102                    | 4.3      | No                 |
|                                               |                        | D/A      | D/A                   |        | 93                     | 4.1      |                    |

Note: For each intersection, LOS and V/C ratio is shown as AM peak hour on top of PM peak hour. Unsignalized one- and two-way stop controlled intersections are shown as the worst movement from the minor street followed by the worst movement from the major street (e.g. D/A). Unsignalized all-way stop controlled intersections are shown as either better than LOS C (<C) or worse than LOS C (>C).

\*BART generated traffic as a percent of total volume at intersection.

Source: DKS Associates, 1991.

**Table 3.12-21 (cont.)  
Summary of Intersection Traffic Analysis Results - Alternatives 6, 7 or 8  
Year 1998**

| Intersection                                    | W/out Proposed Project |          | With Proposed Project |          | BART-Generated Traffic |          | Significant Impact |
|-------------------------------------------------|------------------------|----------|-----------------------|----------|------------------------|----------|--------------------|
|                                                 | LOS                    | V/C      | LOS                   | V/C      | Amount                 | Percent* |                    |
| <i>South Warm Springs cont'd</i>                |                        |          |                       |          |                        |          |                    |
| 4. I-680 NB Ramps/<br>Scott Creek Rd            | A.M.                   | A/A      |                       | A/A      | 79                     | 4.9      | No                 |
|                                                 | P.M.                   | A/A      |                       | A/A      | 35                     | 2.6      |                    |
| 5. N. Milpitas Bl/<br>Dixon Landing Rd          |                        | E (0.93) |                       | E (0.94) | 73                     | 2.2      | Yes                |
|                                                 |                        | D (0.86) |                       | D (0.88) | 67                     | 1.9      |                    |
| 6. Milmont Drive/<br>Dixon Landing Rd           |                        | F (1.10) |                       | F (1.29) | 303                    | 9.5      | Yes                |
|                                                 |                        | A (0.58) |                       | B (0.70) | 275                    | 11.1     |                    |
| 7. I-880 NB Ramps-Calif.<br>Cr/Dixon Landing Rd |                        | F (1.16) |                       | F (1.33) | 303                    | 9.0      | Yes                |
|                                                 |                        | D (0.82) |                       | E (0.95) | 275                    | 9.3      |                    |
| 8. I-880 SB Ramps/<br>Dixon Landing Rd          |                        | A/A      |                       | A/A      | 68                     | 3.7      | No                 |
|                                                 |                        | A/A      |                       | A/A      | 182                    | 12.1     |                    |
| 9. Warm Springs Rd/BART<br>St S.W.S. North      |                        | --       |                       | A (0.54) | 9                      | 0.4      | No                 |
|                                                 |                        | --       |                       | A (0.46) | 8                      | 0.3      |                    |
| 10. Warm Springs Rd/<br>BART St S.W.S. SE       |                        | --       |                       | B (0.62) | 142                    | 5.6      | No                 |
|                                                 |                        | --       |                       | A (0.51) | 130                    | 5.2      |                    |
| 11. Kato Rd/BART St<br>S.W.S. South             |                        | --       |                       | A (0.51) | 349                    | 24.9     | No                 |
|                                                 |                        | --       |                       | A (0.34) | 317                    | 54.7     |                    |

Note: For each intersection, LOS and V/C ratio is shown as AM peak hour on top of PM peak hour. Unsignalized one- and two-way stop controlled intersections are shown as the worst movement from the minor street followed by the worst movement from the major street (e.g. D/A). Unsignalized all-way stop controlled intersections are shown as either better than LOS C (<C) or worse than LOS C (>C).

\*BART generated traffic as a percent of total volume at intersection.

Source: DKS Associates, 1991.

**Pedestrian and Bicycle Access Routes.** Impacts in the vicinity of the stations would be similar as for the Proposed Project, except for the Irvington Station area where the ease of pedestrian and bicycle circulation would be irrelevant to the BART project.

**Parking.** The proposed parking lots in the station concepts are sized to meet the year 2010 parking demand, discussed under cumulative impacts in this section. The parking demand under existing conditions year 1998 will be less than the parking supply and there will be no significant impact on parking.

**Transit.** The impact of Alternatives 6, 7 or 8 on transit service are similar to the Proposed Project. The SCCTD buses would have 7.8 fewer miles to travel than to the existing Fremont Station. This is a beneficial impact when compared to alternatives with no Warm Springs extension.

**Freight Railroad Operations.** The impacts would be similar to the Proposed Project.

#### **Cumulative Impacts**

The cumulative impact analysis was based on growth forecasts from the Fremont General Plan.

**Station Traffic Impact Analysis.** Alternatives 6, 7 or 8 would have significant impacts at the same intersections as those significantly impacted by the Proposed Project in the vicinity of the proposed Warm Springs and South Warm Springs Stations. Table 3.12-22 shows the intersection analysis results for the year 2010 with Alternatives 6, 7 or 8.

**Parking.** Parking demand was estimated in the same way as for the Proposed Project. Table 3.12-23 shows the estimated parking demand versus the amount to be provided by BART at the station site. Parking supply would be adequate to meet parking demand at both extension stations and no significant impacts would occur.

#### **Construction Period Impacts**

Impacts are similar as for the Proposed Project, except that the Irvington area may experience a shorter construction time period since there would not be an Irvington Station.

Table 3.12-22

Summary of Intersection Traffic Analysis Results - Alternatives 6, 7 or 8  
Year 2010

| Intersection                                  | W/out Proposed Project |           | With Proposed Project |     | BART-Generated Traffic |          | Significant Impact |
|-----------------------------------------------|------------------------|-----------|-----------------------|-----|------------------------|----------|--------------------|
|                                               | LOS                    | V/C       | LOS                   | V/C | Amount                 | Percent* |                    |
| <i>Warm Springs</i>                           |                        |           |                       |     |                        |          |                    |
| 1. Osgood Rd/<br>Durham Rd                    | A.M.                   | E (0.96)  | E (0.97)              |     | 95                     | 1.6      | Yes                |
|                                               | P.M.                   | D (0.87)  | D (0.90)              |     | 86                     | 1.6      |                    |
| 2. I-680 SB Ramps/<br>Durham Rd               |                        | D (0.86)  | D (0.87)              |     | 41                     | 1.0      | Yes                |
|                                               |                        | A (0.50)  | A (0.50)              |     | 37                     | 1.1      |                    |
| 3. I-680 NB Ramps/<br>Durham Rd               |                        | D (0.88)  | D (0.90)              |     | 30                     | 1.2      | Yes                |
|                                               |                        | D (0.81)  | D (0.82)              |     | 33                     | 1.3      |                    |
| 4. S. Grimmer Bl/Osgood<br>Rd-Warm Springs Bl |                        | B (0.62)  | B (0.66)              |     | 217                    | 7.8      | No                 |
|                                               |                        | A (0.46)  | A (0.50)              |     | 197                    | 7.8      |                    |
| 5. Fremont Bl/<br>S. Grimmer Bl               |                        | A (0.59)  | A (0.60)              |     | 81                     | 2.9      | No                 |
|                                               |                        | A (0.45)  | A (0.47)              |     | 74                     | 3.1      |                    |
| 6. Fremont Bl/<br>I-880 NB Ramps              |                        | C (0.71)  | C (0.71)              |     | 47                     | 1.2      | No                 |
|                                               |                        | A (0.42)  | A (0.42)              |     | 43                     | 1.1      |                    |
| 7. Fremont Blvd/Cushing<br>Rd-I-880 SB Ramps  |                        | F (1.09)  | F (1.09)              |     | 25                     | 0.4      | Yes                |
|                                               |                        | C (0.77)  | C (0.77)              |     | 31                     | 0.5      |                    |
| 8. Mohave Dr/<br>Mission Bl                   |                        | D (0.83)  | D (0.90)              |     | 369                    | 5.8      | Yes                |
|                                               |                        | D (0.87)  | E (0.92)              |     | 336                    | 5.8      |                    |
| 9. Warm Springs Bl/BART<br>St W.S. North      |                        | --        | D (0.83)              |     | 509                    | 17.4     | No                 |
|                                               |                        | --        | A (0.46)              |     | 310                    | 17.2     |                    |
| 10. Warm Springs Bl/<br>BART St W.S. South    |                        | --        | B (0.66)              |     | 535                    | 18.1     | No                 |
|                                               |                        | --        | A (0.53)              |     | 487                    | 24.6     |                    |
| 11. Warm Springs Bl/<br>Mission Bl            |                        | E (0.95)  | E (0.96)              |     | 457                    | 5.7      | Yes                |
|                                               |                        | C (0.77)  | D (0.89)              |     | 416                    | 6.2      |                    |
| <i>South Warm Springs</i>                     |                        |           |                       |     |                        |          |                    |
| 1. Milmont Dr/<br>Kato Rd                     |                        | C (0.71)  | D (0.82)              |     | 347                    | 13.6     | No                 |
|                                               |                        | A (0.59)  | D (0.81)              |     | 315                    | 13.7     |                    |
| 2. Warm Springs Bl/<br>Kato Rd/Scott Creek    |                        | E (0.91)  | E (0.94)              |     | 204                    | 4.0      | Yes                |
|                                               |                        | C (60.72) | C (0.77)              |     | 185                    | 4.8      |                    |
| 3. I-680 SB Ramps/<br>Scott Creek Rd          |                        | A (0.35)  | A (0.37)              |     | 116                    | 5.3      | No                 |
|                                               |                        | A (0.45)  | A (0.45)              |     | 105                    | 4.0      |                    |

Notes: For each intersection, LOS and V/C ratio is shown as AM peak hour on top of PM peak hour. Unsignalized one- and two-way stop controlled intersections are shown as the worst movement from the minor street followed by the worst movement from the major street (e.g. D/A). Unsignalized all-way stop controlled intersections are shown as either better than LOS C (<C) or worse than LOS C (>C).

Level of impact assumes implementation of improvements planned by City of Fremont or Milpitas.

\*BART generated traffic as a percent of total volume at intersection.

Source: DKS Associates, 1991.

Table 3.12-22 (cont.)

Summary of Intersection Traffic Analysis Results - Alternatives 6, 7 or 8  
Year 2010

| Intersection                                        | W/out Proposed Project |     | With Proposed Project |     | BART-Generated Traffic |          | Significant Impact |
|-----------------------------------------------------|------------------------|-----|-----------------------|-----|------------------------|----------|--------------------|
|                                                     | LOS                    | V/C | LOS                   | V/C | Amount                 | Percent* |                    |
| <i>South Warm Springs cont'd</i>                    |                        |     |                       |     |                        |          |                    |
| 4. I-680 NB Ramps/<br>Scott Creek Rd                | A.M.                   | A/A | A/A                   |     | 89                     | 5.7      | No                 |
|                                                     | P.M.                   | A/A | A/A                   |     | 40                     | 2.7      |                    |
| 5. N. Milpitas Bl/<br>Dixon Landing Rd              | F (1.01)               |     | F (1.01)              |     | 83                     | 2.3      | Yes                |
|                                                     | D (0.88)               |     | D (0.90)              |     | 75                     | 2.2      |                    |
| 6. Milmont Drive/<br>Dixon Landing Rd               | F (1.02)               |     | F (1.23)              |     | 341                    | 9.5      | Yes                |
|                                                     | E (0.97)               |     | F (1.06)              |     | 310                    | 8.6      |                    |
| 7. I-880 NB Ramps-California<br>Cr/Dixon Landing Rd | E (0.96)               |     | F (1.13)              |     | 341                    | 6.3      | Yes                |
|                                                     | C (0.78)               |     | C (0.78)              |     | 310                    | 7.1      |                    |
| 8. I-880 SB Ramps/<br>Dixon Landing Rd              | A (0.60)               |     | A (0.60)              |     | 76                     | 2.1      | No                 |
|                                                     | A (0.49)               |     | A (0.49)              |     | 205                    | 5.1      |                    |
| 9. Warm Springs Rd/BART<br>St S.W.S. North          | --                     |     | A (0.51)              |     | 10                     | 0.4      | No                 |
|                                                     | --                     |     | A (0.52)              |     | 9                      | 0.4      |                    |
| 10. Warm Springs Rd/<br>BART St S.W.S. SE           | --                     |     | A (0.58)              |     | 160                    | 5.5      | No                 |
|                                                     | --                     |     | B (0.61)              |     | 147                    | 5.8      |                    |
| 11. Kato Rd/BART St<br>S.W.S. South                 | --                     |     | C (0.79)              |     | 393                    | 19.4     | No                 |
|                                                     | --                     |     | A (0.46)              |     | 357                    | 24.7     |                    |

Notes: For each intersection, LOS and V/C ratio is shown as AM peak hour on top of PM peak hour. Unsignalized one- and two-way stop controlled intersections are shown as the worst movement from the minor street followed by the worst movement from the major street (e.g. D/A). Unsignalized all-way stop controlled intersections are shown as either better than LOS C (<C) or worse than LOS C (>C).

Level of impact assumes implementation of improvements planned by City of Fremont or Milpitas.

\*BART generated traffic as a percent of total volume at intersection.

Source: DKS Associates, 1991.

**Mitigation Measures**

Mitigation measures in the vicinity of Warm Springs and South Warm Springs Stations are the same as for the Proposed Project, except that the Osgood/Durham intersection would have a residual impact of being 0.01 over the City of Fremont's objective of a 0.85 V/C ratio.

**Residual Impacts After Mitigation**

Residual impacts after mitigation are the same as the Proposed Project, except there would be none in the vicinity of the Irvington Station.

**Table 3.12-23  
Adequacy of Parking Supply  
Alternative 6, 7, or 8**

|                                    | Warm Springs Station | South Warm Springs Station |
|------------------------------------|----------------------|----------------------------|
| Estimated Year 2010 Parking Demand | 1,410                | 1,580 <sup>1</sup>         |
| Approx. # of Stalls                | 2,100                | 2,400                      |

<sup>1</sup> Includes parking demand for transportation services other than BART.

Source: DKS Associates, 1991

Note: Parking supply estimates are based on station concept drawings. As the stations are designed, the actual parking supply could change. BART plans to meet, as a minimum, the year 2010 parking demand.

**3.12.10 IMPACTS OF ALTERNATIVE 9 - A 5.4-Mile BART Extension with One Station (Warm Springs)**

**Table 3.12-24  
Estimated Peak Hour Auto Trip Generation  
New Station, Alternative 9**

|             | Warm Springs<br>---- Station ---- |            |            |
|-------------|-----------------------------------|------------|------------|
|             | 1991                              | 1998       | 2010       |
| AM Inbound  | 507                               | 564        | 664        |
| AM Outbound | <u>133</u>                        | <u>148</u> | <u>175</u> |
| AM TOTAL    | 640                               | 712        | 839        |
| PM Inbound  | 193                               | 214        | 252        |
| PM Outbound | <u>390</u>                        | <u>434</u> | <u>510</u> |
| PM TOTAL    | 583                               | 648        | 762        |

Source: DKS Associates, 1991.

**Direct Impacts**

**Station Traffic Impacts Analysis.** The methodology of the station traffic impact analysis is the same as used for the Proposed Project presented in Section 3.12-2. Table 3.12-24 shows the results of the patronage analysis from the perspective of automobile traffic generation at each of the proposed stations for existing conditions, year 1998 and year 2010. Table 3.12-25 and Table 3.12-26 show the intersection analysis results for 1991 and 1998 under Alternative 9. Impacts under Alternative 9 would be essentially the same as the

**Table 3.12-25**  
**Summary of Intersection Traffic Analysis Results**  
**Existing<sup>1</sup> Plus Alternative 9**

| Intersection                                  | W/out Proposed Project |          | With Proposed Project |        | BART-Generated Traffic |                      | Significant Impact |
|-----------------------------------------------|------------------------|----------|-----------------------|--------|------------------------|----------------------|--------------------|
|                                               | LOS                    | V/C      | LOS                   | V/C    | Amount                 | Percent <sup>2</sup> |                    |
| <i>Warm Springs</i>                           |                        |          |                       |        |                        |                      |                    |
| 1. Osgood Rd/<br>Durham Rd                    | A.M.                   | C (0.74) | C                     | (0.75) | 64                     | 1.7                  | No                 |
|                                               | P.M.                   | C (0.77) | D                     | (0.81) | 58                     | 1.6                  |                    |
| 2. I-680 SB Ramps/<br>Durham Rd               |                        | A (0.55) | A                     | (0.55) | 13                     | 0.4                  | No                 |
|                                               |                        | A (0.51) | A                     | (0.51) | 12                     | 0.4                  |                    |
| 3. I-680 NB Ramps/<br>Durham Rd               |                        | A (0.44) | A                     | (0.44) | 8                      | 0.5                  | No                 |
|                                               |                        | A (0.36) | A                     | (0.37) | 10                     | 0.6                  |                    |
| 4. S. Grimmer Bl/Osgood<br>Rd-Warm Springs Bl |                        | >C       | >C                    |        | 192                    | 8.2                  | Yes                |
|                                               |                        | >C       | >C                    |        | 175                    | 9.7                  |                    |
| 5. Fremont Bl/<br>S. Grimmer Bl               |                        | A (0.42) | A                     | (0.44) | 109                    | 5.5                  | No                 |
|                                               |                        | A (0.38) | A                     | (0.40) | 99                     | 5.4                  |                    |
| 6. Fremont Bl/<br>I-880 NB Ramps              |                        | F/A      | F/A                   |        | 83                     | 5.4                  | Yes                |
|                                               |                        | D/A      | E/A                   |        | 76                     | 4.6                  |                    |
| 7. Fremont Blvd/Cushing<br>Rd-I-880 SB Ramps  |                        | >C       | >C                    |        | 27                     | 1.4                  | Yes                |
|                                               |                        | >C       | >C                    |        | 53                     | 4.4                  |                    |
| 8. Mohave Dr/<br>Mission Bl                   |                        | B (0.67) | C                     | (0.79) | 208                    | 5.0                  | Yes                |
|                                               |                        | E (0.95) | F                     | (1.08) | 189                    | 4.0                  |                    |
| 9. Warm Springs Bl/BART<br>St W.S. North      |                        | --       | A                     | (0.60) | 357                    | 16.1                 | No                 |
|                                               |                        | --       | A                     | (0.57) | 240                    | 11.3                 |                    |
| 10. Warm Springs Bl/<br>BART St W.S. South    |                        | --       | B                     | (0.64) | 486                    | 20.7                 | No                 |
|                                               |                        | --       | B                     | (0.69) | 443                    | 19.1                 |                    |
| 11. Warm Springs Bl/<br>Mission Bl            |                        | D (0.82) | C                     | (0.80) | 445                    | 7.4                  | Yes                |
|                                               |                        | D (0.85) | E                     | (0.98) | 405                    | 5.3                  |                    |

Note: For each intersection, LOS and V/C ratio shown as A.M. peak hour on top of PM peak hour. Unsignalized one- and two-way stop controlled intersections are shown as the worst moment for the minor street followed by the worst moment for the major street (e.g. D/A). Unsignalized all-way stop controlled intersections are shown as either better than LOS C (<C) or worse than LOS C (>C).

<sup>1</sup>Existing conditions are based on conditions from 1988-1990.

<sup>2</sup>BART generated traffic as a percent of total approach volume at intersection.

Source: DKS Associates, 1991.

**Table 3.12-26**  
**Summary of Intersection Traffic Analysis Results - Alternative 9**  
**Year 1998**

| Intersection                                  | W/out Proposed Project |          | With Proposed Project |     | BART-Generated Traffic |          | Significant Impact |
|-----------------------------------------------|------------------------|----------|-----------------------|-----|------------------------|----------|--------------------|
|                                               | LOS                    | V/C      | LOS                   | V/C | Amount                 | Percent* |                    |
| <i>Warm Springs</i>                           |                        |          |                       |     |                        |          |                    |
| 1. Osgood Rd/<br>Durham Rd                    | A.M.                   | C (0.79) | C (0.79)              |     | 71                     | 1.5      | Yes                |
|                                               | P.M.                   | D (0.85) | D (0.86)              |     | 65                     | 1.5      |                    |
| 2. I-680 SB Ramps/<br>Durham Rd               |                        | B (0.64) | B (0.64)              |     | 14                     | 0.3      | No                 |
|                                               |                        | A (0.59) | A (0.60)              |     | 13                     | 0.4      |                    |
| 3. I-680 NB Ramps/<br>Durham Rd               |                        | A (0.51) | A (0.51)              |     | 9                      | 0.5      | No                 |
|                                               |                        | A (0.42) | A (0.43)              |     | 11                     | 0.5      |                    |
| 4. S. Grimmer Bl/Osgood<br>Rd-Warm Springs Bl |                        | >C       | >C                    |     | 214                    | 7.7      | Yes                |
|                                               |                        | >C       | >C                    |     | 194                    | 9.0      |                    |
| 5. Fremont Bl/<br>S. Grimmer Bl               |                        | A (0.49) | A (0.50)              |     | 121                    | 5.1      | No                 |
|                                               |                        | A (0.44) | A (0.45)              |     | 110                    | 5.0      |                    |
| 6. Fremont Bl/<br>I-880 NB Ramps              |                        | F/A      | F/A                   |     | 93                     | 5.1      | Yes                |
|                                               |                        | E/B      | E/C                   |     | 84                     | 4.2      |                    |
| 7. Fremont Blvd/Cushing<br>Rd-I-880 SB Ramps  |                        | >C       | >C                    |     | 30                     | 1.3      | Yes                |
|                                               |                        | >C       | >C                    |     | 59                     | 4.0      |                    |
| 8. Mohave Dr/<br>Mission Bl                   |                        | C (0.80) | D (0.84)              |     | 231                    | 4.6      | Yes                |
|                                               |                        | F (1.25) | F (1.29)              |     | 211                    | 3.7      |                    |
| 9. Warm Springs Bl/BART<br>St W.S. North      |                        | --       | B (0.69)              |     | 398                    | 15.1     | No                 |
|                                               |                        | --       | B (0.55)              |     | 266                    | 10.6     |                    |
| 10. Warm Springs Bl/<br>BART St W.S. South    |                        | --       | C (0.74)              |     | 541                    | 19.5     | No                 |
|                                               |                        | --       | D (0.82)              |     | 492                    | 17.9     |                    |
| 11. Warm Springs Bl/<br>Mission Bl            |                        | E (0.96) | F (1.03)              |     | 495                    | 6.9      | Yes                |
|                                               |                        | F (1.02) | F (1.07)              |     | 450                    | 5.0      |                    |

Note: For each intersection, LOS and V/C ratio is shown as AM peak hour on top of PM peak hour. Unsignalized one- and two-way stop controlled intersections are shown as the worst movement from the minor street followed by the worst movement from the major street (e.g. D/A). Unsignalized all-way stop controlled intersections are shown as either better than LOS C (<C) or worse than LOS C (>C).

\*BART generated traffic as a percent of total volume at intersection.

Source: DKS Associates, 1991.



### 3.12 Transportation

Proposed Project for the Warm Springs Station. Streets in the vicinity of other stations would not be affected.

**Pedestrian and Bicycle Access Routes.** Impacts in the vicinity of the station would be similar as for the Proposed Project, except for the Irvington and South Warm Springs station areas where the ease of pedestrian and bicycle circulation would be irrelevant to the BART project.

**Parking.** The proposed parking lot in the station concept is sized to meet the year 2010 parking demand, discussed under cumulative impacts in this section. The demand under existing conditions and year 1998 will be less than the supply and there will be no significant impact on parking.

**Transit.** The impact of Alternative 9 on transit service is similar to the Proposed Project. The only difference would be that SCCTD buses would need to travel an additional 2.4 miles to reach the connection with BART at Warm Springs Station. The buses would, however, have 5.4 fewer miles to travel than to the existing Fremont BART Station. This is a beneficial impact when compared to alternatives with no Warm Springs extension.

**Freight Railroad Operations.** The impacts would be similar to the Proposed Project.

#### **Cumulative Impacts**

The cumulative impact analysis was based on growth forecasts from the Fremont General Plan.

**Station Traffic Impact Analysis.** Alternative 9 would have significant impacts at the same intersections as those significantly impacted by the Proposed Project in the vicinity of the proposed Warm Springs Station. Table 3.12-27 shows the intersection analysis results for the year 2010 with Alternative 9.

**Parking.** Parking demand was estimated in the same way as for the Proposed Project. Table 3.12-28 shows estimated parking demand versus the amount to be provided at the station site. The proposed Warm Springs Station would have more parking available in this alternative than that in the Proposed Project. Parking supply would be adequate to meet parking demand at the station and no significant impacts would occur.

**Table 3.12-27**  
**Summary of Intersection Traffic Analysis Results - Alternative 9**  
**Year 2010**

| Intersection                                  | W/out Proposed Project |          | With Proposed Project |     | BART-Generated Traffic |          | Significant Impact |
|-----------------------------------------------|------------------------|----------|-----------------------|-----|------------------------|----------|--------------------|
|                                               | LOS                    | V/C      | LOS                   | V/C | Amount                 | Percent* |                    |
| <b>Warm Springs</b>                           |                        |          |                       |     |                        |          |                    |
| 1. Osgood Rd/<br>Durham Rd                    | A.M.                   | E (0.96) | E (0.97)              |     | 84                     | 1.4      | Yes                |
|                                               | P.M.                   | D (0.87) | D (0.87)              |     | 76                     | 1.4      |                    |
| 2. I-680 SB Ramps/<br>Durham Rd               |                        | D (0.86) | D (0.86)              |     | 17                     | 0.4      | Yes                |
|                                               |                        | A (0.50) | A (0.50)              |     | 15                     | 0.5      |                    |
| 3. I-680 NB Ramps/<br>Durham Rd               |                        | D (0.88) | D (0.89)              |     | 10                     | 0.4      | Yes                |
|                                               |                        | D (0.81) | D (0.81)              |     | 13                     | 0.5      |                    |
| 4. S. Grimmer Bl/Osgood<br>Rd-Warm Springs Bl |                        | B (0.62) | B (0.66)              |     | 252                    | 9.0      | No                 |
|                                               |                        | A (0.46) | A (0.46)              |     | 229                    | 9.0      |                    |
| 5. Fremont Bl/<br>S. Grimmer Bl               |                        | A (0.59) | B (0.61)              |     | 143                    | 5.1      | No                 |
|                                               |                        | A (0.45) | A (0.45)              |     | 130                    | 5.3      |                    |
| 6. Fremont Bl/<br>I-880 NB Ramps              |                        | C (0.71) | C (0.71)              |     | 109                    | 2.6      | No                 |
|                                               |                        | A (0.42) | A (0.42)              |     | 99                     | 2.5      |                    |
| 7. Fremont Blvd/Cushing<br>Rd-I-880 SB Ramps  |                        | F (1.09) | F (1.09)              |     | 35                     | 0.6      | Yes                |
|                                               |                        | C (0.77) | C (0.77)              |     | 69                     | 1.2      |                    |
| 8. Mohave Dr/<br>Mission Bl                   |                        | D (0.83) | D (0.90)              |     | 273                    | 4.4      | Yes                |
|                                               |                        | D (0.87) | E (0.87)              |     | 248                    | 4.3      |                    |
| 9. Warm Springs Bl/BART<br>St W.S. North      |                        | --       | C (0.76)              |     | 468                    | 16.2     | No                 |
|                                               |                        | --       | A (0.46)              |     | 313                    | 17.3     |                    |
| 10. Warm Springs Bl/<br>BART St W.S. South    |                        | --       | C (0.80)              |     | 638                    | 20.9     | No                 |
|                                               |                        | --       | A (0.61)              |     | 579                    | 27.9     |                    |
| 11. Warm Springs Bl/<br>Mission Bl            |                        | E (0.95) | F (1.01)              |     | 583                    | 7.1      | Yes                |
|                                               |                        | C (0.77) | C (0.77)              |     | 530                    | 7.7      |                    |

Notes: For each intersection, LOS and V/C ratio is shown as AM peak hour on top of PM peak hour. Unsignalized one- and two-way stop controlled intersections are shown as the worst movement from the minor street followed by the worst movement from the major street (e.g. D/A). Unsignalized all-way stop controlled intersections are shown as either better than LOS C (<C) or worse than LOS C (>C).

Level of impact assumes implementation of improvements planned by City of Fremont or Milpitas.

\*BART generated traffic as a percent of total volume at intersection.

Source: DKS Associates, 1991.

### Construction Period Impacts

Impacts are similar as for the Proposed Project, except that the area south of Warm Springs Station is not affected and the Irvington area may experience a shorter construction time period since there would not be an Irvington Station.

### Mitigation Measures

Mitigation measures in the vicinity of the Warm Springs Station are the same as for the Proposed Project.

### Residual Impacts After Mitigation

Residual impacts after mitigation are the same as the Proposed Project, except there would be none in the vicinity of the Irvington and South Warm Springs Stations. The intersection of Warm Springs Boulevard and the southern station entrance/exit at the proposed Warm Springs Station would have a residual impact of being 0.02 over the City of Fremont's objective of a 0.85 V/C ratio.

**Table 3.12-28  
Adequacy of Parking Supply  
Alternative 9**

|                                       | Warm Springs<br>Station |
|---------------------------------------|-------------------------|
| Estimated Year 2010<br>Parking Demand | 2,300 <sup>1</sup>      |
| Approx. # of Stalls                   | 2,300                   |

<sup>1</sup>Includes parking demand for transportation services other than BART.

Source: DKS Associates, 1991

Note: Parking supply estimates are based on station concept drawings. As the stations are designed, the actual parking supply could change. BART plans to meet, as a minimum, the year 2010 parking demand.

### 3.12.11 IMPACTS OF ALTERNATIVE 10 -- A 7.8-Mile BART Extension with One Station (South Warm Springs)

#### Direct Impacts

**Station Traffic Impacts Analysis.** The methodology for the station traffic impact analysis is the same as used for the Proposed Project presented in Section 3.12-2. Table 3.12-29 shows the results of the patronage analysis from the perspective of automobile traffic generation at each of the proposed stations for existing conditions, year 1998 and year 2010. Table 3.12-30 and Table 3.12-31 show the intersection analysis results for 1991 and 1998 under Alternative 10.

Impacts for Alternative 10 would be essentially the same as the Proposed Project in the South Warm Springs Station vicinity. Streets in the vicinity of other stations would not be effected.

**Table 3.12-29**  
**Estimated Peak Hour Auto Trip Generation**  
**New Station(s), Alternative 10**

|             | South Warm Springs<br>--- Station --- |            |            |
|-------------|---------------------------------------|------------|------------|
|             | 1991                                  | 1998       | 2010       |
| AM Inbound  | 840                                   | 919        | 1,062      |
| AM Outbound | <u>221</u>                            | <u>242</u> | <u>279</u> |
| AM TOTAL    | 1,061                                 | 1,161      | 1,341      |
| PM Inbound  | 319                                   | 349        | 403        |
| PM Outbound | <u>646</u>                            | <u>707</u> | <u>817</u> |
| PM TOTAL    | 965                                   | 1,056      | 1,220      |

Source: DKS Associates, 1991.

**Pedestrian and Bicycle Access Routes.** Impacts in the vicinity of the station would be similar as for the Proposed Project, except for the Irvington and Warm Springs Station area where the ease of pedestrian and bicycle circulation would be irrelevant to the BART project.

**Parking.** The proposed parking lot in the station concept is sized to meet the year 2010 parking demand, discussed under cumulative impacts in this section. The demand under existing conditions and year 1998 will be less than the supply and there will be no significant impact on parking.

**Transit.** The impact of Alternative 10 on transit service is similar to the Proposed Project. The SCCTD buses would have 7.8 fewer miles to travel than to the existing Fremont BART Station. This is a beneficial impact when compared to alternatives with no Warm Springs extension.

**Freight Railroad Operations.** The impacts would be similar to the Proposed Project.

### Cumulative Impacts

The cumulative impact analysis was based on growth forecasts from the Fremont General Plan.

**Station Traffic Impact Analysis.** Alternative 10 would have significant impacts at the same intersections as those significantly impacted by the Proposed Project in the vicinity of the proposed South Warm Springs Stations. Table 3.12-32 shows the intersection analysis results for the year 2010 with Alternative 10.

**Parking.** Parking demand was estimated in the same way as for the Proposed Project. Table 3.12-33 shows estimated parking demand versus the amount to be provided at the proposed station site. The proposed South Warm Springs Station would have more parking available in this alternative than that in the Proposed Project. Parking supply would be adequate to meet parking demand at both of the proposed stations and no significant impacts would occur.

**Table 3.12-30**  
**Summary of Intersection Traffic Analysis Results**  
**Existing<sup>1</sup> Plus Alternative 10**

| Intersection                                        | W/out Proposed Project |     | With Proposed Project |     | BART-Generated Traffic |                      | Significant Impact |
|-----------------------------------------------------|------------------------|-----|-----------------------|-----|------------------------|----------------------|--------------------|
|                                                     | LOS                    | V/C | LOS                   | V/C | Amount                 | Percent <sup>2</sup> |                    |
| <i>South Warm Springs</i>                           |                        |     |                       |     |                        |                      |                    |
| 1. Milmont Dr/<br>Kato Rd                           | A.M.                   | F/C | F/D                   |     | 404                    | 19.8                 | Yes                |
|                                                     | P.M.                   | F/A | F/B                   |     | 367                    | 24.5                 |                    |
| 2. Warm Springs Bl/<br>Kato Rd/Scott Creek Rd       | B (0.65)               |     | E (0.92)              |     | 616                    | 17.0                 | Yes                |
|                                                     | E (0.97)               |     | F (1.15)              |     | 560                    | 14.8                 |                    |
| 3. I-680 SB Ramps/<br>Scott Creek Rd                |                        | D/A | E/A                   |     | 499                    | 21.0                 | No                 |
|                                                     |                        | C/A | D/A                   |     | 454                    | 20.2                 |                    |
| 4. I-680 NB Ramps/<br>Scott Creek Rd                |                        | A/A | A/A                   |     | 398                    | 23.8                 | No                 |
|                                                     |                        | A/A | A/A                   |     | 225                    | 17.2                 |                    |
| 5. N. Milpitas Bl/<br>Dixon Landing Rd              | C (0.80)               |     | D (0.81)              |     | 106                    | 3.8                  | No                 |
|                                                     | B (0.66)               |     | C (0.71)              |     | 97                     | 3.4                  |                    |
| 6. Milmont Dr/<br>Dixon Landing Rd                  | D (0.85)               |     | F (1.16)              |     | 393                    | 14.0                 | Yes                |
|                                                     | A (0.44)               |     | B (0.68)              |     | 357                    | 16.2                 |                    |
| 7. I-880 NB Ramps-California<br>Cr/Dixon Landing Rd | E (0.96)               |     | F (1.17)              |     | 393                    | 13.3                 | Yes                |
|                                                     | C (0.77)               |     | D (0.89)              |     | 357                    | 13.8                 |                    |
| 8. I-880 SB Ramps/<br>Dixon Landing Rd              |                        | A/A | A/A                   |     | 116                    | 7.3                  | No                 |
|                                                     |                        | A/A | A/A                   |     | 221                    | 16.7                 |                    |
| 9. Warm Springs Rd/BART<br>St S.W.S. North          |                        | --  | A (0.48)              |     | 61                     | 3.0                  | No                 |
|                                                     |                        | --  | A (0.40)              |     | 56                     | 2.8                  |                    |
| 10. Warm Springs Rd/<br>BART St S.W.S. SE           |                        | --  | C (0.79)              |     | 526                    | 20.8                 | No                 |
|                                                     |                        | --  | B (0.64)              |     | 489                    | 20.0                 |                    |
| 11. Kato Rd/BART St<br>S.W.S. South                 |                        | --  | A (0.54)              |     | 526                    | 37.5                 | No                 |
|                                                     |                        | --  | A (0.39)              |     | 478                    | 68.7                 |                    |

Note: For each intersection, LOS and V/C ratio shown as A.M. peak hour on top of PM peak hour. Unsignalized one- and two-way stop can controlled intersections are shown as the worst moment for the minor street followed by the worst moment for the major street (e.g. D/A). Unsignalized all-way stop controlled intersections are shown as either better than LOS C (<C) or worse than LOS C (>C).

<sup>1</sup>Existing conditions are based on conditions from 1988-1990.

<sup>2</sup>BART generated traffic as a percent of total approach volume at intersection.

Source: DKS Associates, 1991.

**Table 3.12-31**  
**Summary of Intersection Traffic Analysis Results - Alternative 10**  
**Year 1998**

| Intersection                                        | W/out Proposed Project |          | With Proposed Project |          | BART-Generated Traffic |          | Significant Impact |
|-----------------------------------------------------|------------------------|----------|-----------------------|----------|------------------------|----------|--------------------|
|                                                     | LOS                    | V/C      | LOS                   | V/C      | Amount                 | Percent* |                    |
| <i>South Warm Springs</i>                           |                        |          |                       |          |                        |          |                    |
| 1. Milmont Dr/<br>Kato Rd                           | A.M.                   | F/D      |                       | F/E      | 442                    | 18.4     | Yes                |
|                                                     | P.M.                   | F/A      |                       | F/C      | 402                    | 22.8     |                    |
| 2. Warm Springs Bl/<br>Kato Rd/Scott Creek          |                        | C (0.71) |                       | E (0.91) | 674                    | 15.7     | Yes                |
|                                                     |                        | D (0.82) |                       | E (0.94) | 614                    | 13.7     |                    |
| 3. I-680 SB Ramps/<br>Scott Creek Rd                |                        | E/A      |                       | E/A      | 546                    | 19.5     | No                 |
|                                                     |                        | D/A      |                       | E/A      | 497                    | 18.8     |                    |
| 4. I-680 NB Ramps/<br>Scott Creek Rd                |                        | A/A      |                       | A/A      | 436                    | 22.2     | No                 |
|                                                     |                        | A/A      |                       | A/A      | 246                    | 16.0     |                    |
| 5. N. Milpitas Bl/<br>Dixon Landing Rd              |                        | E (0.93) |                       | E (0.94) | 116                    | 3.5      | Yes                |
|                                                     |                        | D (0.86) |                       | C (0.74) | 106                    | 3.1      |                    |
| 6. Milmont Dr/<br>Dixon Landing Rd                  |                        | F (1.10) |                       | F (1.37) | 430                    | 13.0     | Yes                |
|                                                     |                        | A (0.58) |                       | C (0.79) | 391                    | 15.0     |                    |
| 7. I-880 NB Ramps-California<br>Cr/Dixon Landing Rd |                        | F (1.16) |                       | F (1.38) | 430                    | 12.3     | Yes                |
|                                                     |                        | D (0.82) |                       | E (0.98) | 391                    | 12.7     |                    |
| 8. I-880 SB Ramps/<br>Dixon Landing Rd              |                        | A/A      |                       | A/A      | 127                    | 6.7      | No                 |
|                                                     |                        | A/A      |                       | A/A      | 242                    | 15.5     |                    |
| 9. Warm Springs Rd/BART<br>St S.W.S. North          |                        | --       |                       | A (0.55) | 67                     | 2.7      | No                 |
|                                                     |                        | --       |                       | A (0.48) | 61                     | 2.5      |                    |
| 10. Warm Springs Rd/<br>BART St S.W.S. SE           |                        | --       |                       | C (0.79) | 575                    | 19.3     | No                 |
|                                                     |                        | --       |                       | C (0.72) | 536                    | 18.6     |                    |
| 11. Kato Rd/BART St<br>S.W.S. South                 |                        | --       |                       | B (0.61) | 575                    | 35.3     | No                 |
|                                                     |                        | --       |                       | A (0.42) | 524                    | 66.8     |                    |

Note: For each intersection, LOS and V/C ratio is shown as AM peak hour on top of PM peak hour. Unsignalized one- and two-way stop controlled intersections are shown as the worst movement from the minor street followed by the worst movement from the major street (e.g. D/A). Unsignalized all-way stop controlled intersections are shown as either better than LOS C (<C) or worse than LOS C (>C).

\*BART generated traffic as a percent of total volume at intersection.

Source: DKS Associates, 1991.

**Table 3.12-32**  
**Summary of Intersection Traffic Analysis Results - Alternative 10**  
**Year 2010**

| Intersection                                     | W/out Proposed Project         |     | With Proposed Project |     | BART-Generated Traffic |              | Significant Impact |
|--------------------------------------------------|--------------------------------|-----|-----------------------|-----|------------------------|--------------|--------------------|
|                                                  | LOS                            | V/C | LOS                   | V/C | Amount                 | Percent*     |                    |
| <i>South Warm Springs</i>                        |                                |     |                       |     |                        |              |                    |
| 1. Milmont Dr/<br>Kato Rd                        | A.M. C (0.71)<br>P.M. A (0.59) |     | D (0.88)<br>C (0.79)  |     | 510<br>464             | 18.7<br>19.0 | Yes                |
| 2. Warm Springs Bl/<br>Kato Rd/Scott Creek       | E (0.91)<br>C (0.72)           |     | F (1.10)<br>D (0.88)  |     | 778<br>709             | 13.6<br>16.1 | Yes                |
| 3. I-680 SB Ramps/<br>Scott Creek Rd             | A (0.35)<br>A (0.45)           |     | A (0.48)<br>A (0.48)  |     | 631<br>574             | 23.5<br>18.7 | No                 |
| 4. I-680 NB Ramps/<br>Scott Creek Rd             | A/A<br>A/A                     |     | A/A<br>B/A            |     | 504<br>284             | 25.4<br>16.3 | No                 |
| 5. N. Milpitas Bl/<br>Dixon Landing Rd           | F (1.01)<br>D (0.88)           |     | F (1.01)<br>E (0.92)  |     | 134<br>122             | 3.6<br>3.5   | Yes                |
| 6. Milmont Dr/<br>Dixon Landing Rd               | F (1.02)<br>E (0.97)           |     | F (1.32)<br>F (1.15)  |     | 497<br>452             | 13.2<br>12.0 | Yes                |
| 7. I-880 NB Ramps-California<br>Cr/Dixon Landing | E (0.96)<br>C (0.78)           |     | F (1.18)<br>D (0.82)  |     | 497<br>452             | 8.1<br>10.1  | Yes                |
| 8. I-880 SB Ramps/<br>Dixon Landing Rd           | A (0.60)<br>A (0.49)           |     | B (0.62)<br>A (0.50)  |     | 147<br>280             | 4.0<br>6.8   | No                 |
| 9. Warm Springs Rd/BART<br>St S.W.S. North       | --<br>--                       |     | A (0.52)<br>A (0.53)  |     | 77<br>70               | 2.7<br>2.9   | No                 |
| 10. Warm Springs Rd/<br>BART St S.W.S. SE        | --<br>--                       |     | C (0.79)<br>C (0.79)  |     | 665<br>619             | 19.4<br>20.7 | No                 |
| 11. Kato Rd/BART St<br>S.W.S. South              | --<br>--                       |     | C (0.80)<br>A (0.52)  |     | 664<br>605             | 28.9<br>35.8 | No                 |

Notes: For each intersection, LOS and V/C ratio is shown as AM peak hour on top of PM peak hour. Unsignalized one- and two-way stop controlled intersections are shown as the worst movement from the minor street followed by the worst movement from the major street (e.g. D/A). Unsignalized all-way stop controlled intersections are shown as either better than LOS C (<C) or worse than LOS C (>C).

Level of impact assumes implementation of improvements planned by City of Fremont or Milpitas.

\*BART generated traffic as a percent of total volume at intersection.

Source: DKS Associates, 1991.

**Construction Period Impacts**

Impacts are similar as for the Proposed Project, except that the Irvington area and area near the Warm Springs Station may experience a shorter construction time period.

**Mitigation Measures**

Mitigation measures in the vicinity of the South Warm Springs Station are the same as for the Proposed Project.

**Residual Impacts After Mitigation**

Residual impacts after mitigation are the same as the Proposed Project, except there are none in the vicinity of the Irvington and Warm Springs Stations.

**3.12.12 IMPACTS OF ALTERNATIVE 11 -- A 7.8-Mile BART Extension with Two Stations (Irvington and South Warm Springs)****Direct Impacts**

**Station Traffic Impacts Analysis.** The methodology of the station traffic impact analysis is the same as used for the Proposed Project presented in Section 3.12-2. Table 3.12-34 shows the results of the patronage analysis from the perspective of automobile traffic generation at each of the proposed stations for existing conditions, year 1998 and year 2010. Table 3.12-35 and Table 3.12-36 show the intersection analysis results for 1991 and 1998 under Alternative 11.

Impacts under Alternative 11 would be essentially the same as the Proposed Project except near the Warm Springs Station where there would be no impact.

**Pedestrian and Bicycle Access Routes.** Impacts in the vicinity of the stations would be similar as for the Proposed Project, except for the Warm Springs Station area where the ease of

**Table 3.12-33  
Adequacy of Parking Supply  
Alternative 10**

|                                       | South Warm<br>Springs Station |
|---------------------------------------|-------------------------------|
| Estimated Year 2010<br>Parking Demand | 3,230 <sup>1</sup>            |
| Approximate Number of Stalls          | 3,300                         |

<sup>1</sup>Includes parking demand for transportation services other than BART.

Source: DKS Associates, 1991

Note: Parking supply estimates are based on station concept drawings. As the stations are designed, the actual parking supply could change. BART plans to meet, as a minimum, the year 2010 parking demand.



**Table 3.12-34**  
**Estimated Peak Hour Auto Trip Generation**  
**New BART Stations, Alternative 11**

|             | Irvington<br>--- Station --- |            |            | South Warm Springs<br>---- Station ---- |            |            |
|-------------|------------------------------|------------|------------|-----------------------------------------|------------|------------|
|             | 1991                         | 1998       | 2010       | 1991                                    | 1998       | 2010       |
| AM Inbound  | 343                          | 373        | 421        | 641                                     | 689        | 776        |
| AM Outbound | <u>90</u>                    | <u>98</u>  | <u>111</u> | <u>169</u>                              | <u>181</u> | <u>204</u> |
| AM TOTAL    | 433                          | 471        | 532        | 810                                     | 870        | 980        |
| PM Inbound  | 130                          | 142        | 160        | 244                                     | 262        | 295        |
| PM Outbound | <u>264</u>                   | <u>287</u> | <u>324</u> | <u>493</u>                              | <u>530</u> | <u>597</u> |
| PM TOTAL    | 394                          | 429        | 484        | 737                                     | 792        | 892        |

Source: DKS Associates, 1991

pedestrian and bicycle circulation would be irrelevant to the BART project.

**Parking.** The proposed parking lots in the station concepts are sized to meet the year 2010 parking demand, discussed under cumulative impacts in this section. The demand under existing conditions and year 1998 will be less than the supply and there will be no significant impact on parking.

**Transit.** The impact of Alternative 11 on transit service are similar to the Proposed Project. The SCCD buses would, however, have 7.8 fewer miles to travel than to the existing Fremont BART Station. This is a beneficial impact when compared to alternatives with no Warm Springs extension.

**Freight Railroad Operations.** The impacts would be similar to the Proposed Project.

### Cumulative Impacts

The cumulative impact analysis was based on growth forecasts from the Fremont General Plan.

**Station Traffic Impact Analysis.** Alternative 11 would have significant impacts at the same intersections as those significantly impacted by the Proposed Project in the vicinity of the

**Table 3.12-35**  
**Summary of Intersection Traffic Analysis Results**  
**Existing<sup>1</sup> Plus Alternative 11**

| Intersection                                  | W/out Proposed Project |          | With Proposed Project |     | BART-Generated Traffic |                      | Significant Impact |
|-----------------------------------------------|------------------------|----------|-----------------------|-----|------------------------|----------------------|--------------------|
|                                               | LOS                    | V/C      | LOS                   | V/C | Amount                 | Percent <sup>2</sup> |                    |
| <i>Irvington</i>                              |                        |          |                       |     |                        |                      |                    |
| 1. Fremont Bl/Bay St/<br>Washington Bl        | A.M.                   | B (0.62) | B (0.64)              |     | 48                     | 2.4                  | No                 |
|                                               | P.M.                   | B (0.66) | B (0.69)              |     | 43                     | 1.6                  |                    |
| 2. Driscoll Rd-Osgood Rd/<br>Washington Bl    |                        | D (0.83) | F (1.23)              |     | 168                    | 5.3                  | Yes                |
|                                               |                        | C (0.78) | E (0.94)              |     | 153                    | 4.5                  |                    |
| 3. I-680 SB Ramps/<br>Washington Bl           |                        | D/A      | E/A                   |     | 48                     | 3.2                  | No                 |
|                                               |                        | E/B      | E/B                   |     | 43                     | 2.6                  |                    |
| 4. I-680 NB Ramps-Luzon/<br>Washington Bl     |                        | A (0.45) | A (0.52)              |     | 45                     | 2.8                  | No                 |
|                                               |                        | A (0.49) | A (0.59)              |     | 41                     | 2.3                  |                    |
| 5. Osgood Rd/Blacow Rd                        |                        | --       | A (0.51)              |     | 264                    | 18.2                 | No                 |
|                                               |                        | --       | A (0.32)              |     | 240                    | 21.3                 |                    |
| 6. Osgood Rd/BART St<br>Irvington             |                        | --       | A (0.45)              |     | 272                    | 18.7                 | No                 |
|                                               |                        | --       | A (0.40)              |     | 256                    | 22.4                 |                    |
| <i>South Warm Springs</i>                     |                        |          |                       |     |                        |                      |                    |
| 1. Millmont Dr/<br>Kato Rd                    |                        | F/C      | E/D                   |     | 309                    | 15.9                 | Yes                |
|                                               |                        | F/A      | F/A                   |     | 280                    | 19.8                 |                    |
| 2. Warm Springs Bl/<br>Kato Rd/Scott Creek Rd |                        | B (0.65) | D (0.84)              |     | 471                    | 13.5                 | Yes                |
|                                               |                        | E (0.97) | F (1.10)              |     | 428                    | 11.7                 |                    |
| 3. I-680 SB Ramps/<br>Scott Creek Rd          |                        | D/A      | E/A                   |     | 382                    | 16.9                 | No                 |
|                                               |                        | C/A      | D/A                   |     | 347                    | 16.2                 |                    |

Note: For each intersection, LOS and V/C ratio shown as A.M. peak hour on top of PM peak hour. Unsignalized one- and two-way stop controlled intersections are shown as the worst moment for the minor street followed by the worst moment for the major street (e.g. D/A). Unsignalized all-way stop controlled intersections are shown as either better than LOS C (<C) or worse than LOS C (>C).

<sup>1</sup>Existing conditions are based on conditions from 1988-1990.

<sup>2</sup>BART generated traffic as a percent of total approach volume at intersection.

Source: DKS Associates, 1991.

**Table 3.12-35 (cont.)**  
**Summary of Intersection Traffic Analysis Results - Alternative 11**  
**Existing Plus Alternative 11**

| Intersection                                      | W/out Proposed Project |     | With Proposed Project |     | BART-Generated Traffic |                      | Significant Impact |
|---------------------------------------------------|------------------------|-----|-----------------------|-----|------------------------|----------------------|--------------------|
|                                                   | LOS                    | V/C | LOS                   | V/C | Amount                 | Percent <sup>2</sup> |                    |
| <i>South Warm Springs cont.</i>                   |                        |     |                       |     |                        |                      |                    |
| 4. I-680 NB Ramps/<br>Scott Creek Rd              | A/A                    |     | A/A                   |     | 305                    | 19.3                 | No                 |
|                                                   | A/A                    |     | A/A                   |     | 172                    | 13.7                 |                    |
| 5. N. Milpitas Bl/<br>Dixon Landing Rd            | C (0.80)               |     | D (0.81)              |     | 81                     | 3.0                  | No                 |
|                                                   | B (0.66)               |     | C (0.71)              |     | 74                     | 2.6                  |                    |
| 6. Milmont Dr/<br>Dixon Landing Rd                | D (0.85)               |     | F (1.10)              |     | 300                    | 11.1                 | Yes                |
|                                                   | A (0.44)               |     | B (0.63)              |     | 273                    | 12.9                 |                    |
| 7. I-880 NB Rps-California<br>Cr/Dixon Landing Rd | E (0.96)               |     | F (1.12)              |     | 300                    | 10.5                 | Yes                |
|                                                   | C (0.77)               |     | D (0.83)              |     | 273                    | 10.9                 |                    |
| 8. I-880 SB Ramps/<br>Dixon Landing Rd            | A/A                    |     | A/A                   |     | 89                     | 5.7                  | No                 |
|                                                   | A/A                    |     | A/A                   |     | 169                    | 13.3                 |                    |
| 9. Warm Springs Rd/BART<br>St S.W.S. North        | --                     |     | A (0.48)              |     | 47                     | 2.3                  | No                 |
|                                                   | --                     |     | A (0.40)              |     | 42                     | 2.1                  |                    |
| 10. Warm Springs Rd/<br>BART St S.W.S. SE         | --                     |     | B (0.70)              |     | 402                    | 16.7                 | No                 |
|                                                   | --                     |     | A (0.58)              |     | 374                    | 16.0                 |                    |
| 11. Kato Rd/BART St<br>S.W.S. South               | --                     |     | A (0.48)              |     | 402                    | 31.4                 | No                 |
|                                                   | --                     |     | A (0.33)              |     | 365                    | 62.6                 |                    |

Note: For each intersection, LOS and V/C ratio shown as A.M. peak hour on top of PM peak hour. Unsignalized one- and two-way stop controlled intersections are shown as the worst moment for the minor street followed by the worst moment for the major street (e.g. D/A). Unsignalized all-way stop controlled intersections are shown as either better than LOS C (<C) or worse than LOS C (>C).

<sup>1</sup>Existing conditions are based on conditions from 1988-1990.

<sup>2</sup>BART generated traffic as a percent of total approach volume at intersection.

Source: DKS Associates, 1991.

**Table 3.12-36**  
**Summary of Intersection Traffic Analysis Results - Alternative 11**  
**Year 1998**

| Intersection                               | W/out Proposed Project |          | With Proposed Project |        | BART-Generated Traffic |          | Significant Impact |
|--------------------------------------------|------------------------|----------|-----------------------|--------|------------------------|----------|--------------------|
|                                            | LOS                    | V/C      | LOS                   | V/C    | Amount                 | Percent* |                    |
| <i>Irvington</i>                           |                        |          |                       |        |                        |          |                    |
| 1. Fremont Bl/Bay St/<br>Washington Bl     | A.M.                   | B (0.64) | B                     | (0.68) | 320                    | 13.2     | No                 |
|                                            | P.M.                   | D (0.81) | D                     | (0.84) | 292                    | 9.4      |                    |
| 2. Driscoll Rd-Osgood<br>Washington Bl     | F                      | (1.23)   | F                     | (1.46) | 452                    | 12.2     | Yes                |
|                                            | E                      | (0.95)   | F                     | (1.09) | 412                    | 10.5     |                    |
| 3. I-680 SB Ramps/<br>Washington Bl        | E/A                    |          | E/B                   |        | 52                     | 3.2      | No                 |
|                                            | E/C                    |          | E/C                   |        | 47                     | 2.6      |                    |
| 4. I-680 NB Ramps-Luzon/<br>Washington Bl  | A                      | (0.55)   | A                     | (0.56) | 49                     | 2.8      | No                 |
|                                            | B                      | (0.62)   | B                     | (0.63) | 45                     | 2.3      |                    |
| 5. Osgood Rd/Blacow Rd                     | A                      | (0.41)   | A                     | (0.41) | 19                     | 1.4      | No                 |
|                                            | A                      | (0.29)   | A                     | (0.29) | 17                     | 1.7      |                    |
| 6. Osgood Rd/BART St<br>Irvington          | --                     |          | A                     | (0.45) | 438                    | 25.3     | No                 |
|                                            | --                     |          | A                     | (0.50) | 333                    | 25.6     |                    |
| <i>South Warm Springs</i>                  |                        |          |                       |        |                        |          |                    |
| 1. Milmont Dr/<br>Kato Rd                  | F/D                    |          | F/E                   |        | 331                    | 14.4     | Yes                |
|                                            | F/A                    |          | F/B                   |        | 301                    | 18.2     |                    |
| 2. Warm Springs Bl/<br>Kato Rd/Scott Creek | C                      | (0.71)   | D                     | (0.82) | 506                    | 12.3     | Yes                |
|                                            | D                      | (0.82)   | D                     | (0.87) | 459                    | 10.6     |                    |
| 3. I-680 SB Ramps/<br>Scott Creek Rd       | E/A                    |          | E/A                   |        | 410                    | 15.4     | No                 |
|                                            | D/A                    |          | D/A                   |        | 372                    | 14.7     |                    |

Note: For each intersection, LOS and V/C ratio is shown as AM peak hour on top of PM peak hour. Unsignalized one- and two-way stop controlled intersections are shown as the worst movement from the minor street followed by the worst movement from the major street (e.g. D/A). Unsignalized all-way stop controlled intersections are shown as either better than LOS C (<C) or worse than LOS C (>C).

\*BART generated traffic as a percent of total volume at intersection.

Source: DKS Associates, 1991.

**Table 3.12-36 (cont.)**  
**Summary of Intersection Traffic Analysis Results - Alternative 11**  
**Year 1998**

| Intersection                                        | W/out Proposed Project |          | With Proposed Project |     | BART-Generated Traffic |          | Significant Impact |
|-----------------------------------------------------|------------------------|----------|-----------------------|-----|------------------------|----------|--------------------|
|                                                     | LOS                    | V/C      | LOS                   | V/C | Amount                 | Percent* |                    |
| <i>South Warm Springs (cont.)</i>                   |                        |          |                       |     |                        |          |                    |
| 4. I-680 NB Ramps/<br>Scott Creek Rd                | A.M.                   | A/A      | A/A                   |     | 327                    | 17.6     | No                 |
|                                                     | P.M.                   | A/A      | A/A                   |     | 184                    | 12.4     |                    |
| 5. N. Milpitas Bl/<br>Dixon Landing Rd              | E                      | (0.93)   | E (0.94)              |     | 87                     | 2.7      | Yes                |
|                                                     | D                      | (0.86)   | D (0.88)              |     | 79                     | 2.3      |                    |
| 6. Milmont Dr/<br>Dixon Landing Rd                  | A.M.                   | F (1.10) | F (1.30)              |     | 323                    | 10.1     | Yes                |
|                                                     | P.M.                   | A (0.58) | C (0.71)              |     | 293                    | 11.7     |                    |
| 7. I-880 NB Ramps-California<br>Cr/Dixon Landing Rd | F                      | (1.16)   | F (1.32)              |     | 323                    | 9.5      | Yes                |
|                                                     | D                      | (0.82)   | E (0.94)              |     | 293                    | 9.9      |                    |
| 8. I-880 SB Ramps/<br>Dixon Landing Rd              | A/A                    |          | A/A                   |     | 95                     | 5.1      | No                 |
|                                                     | A/A                    |          | A/A                   |     | 181                    | 12.0     |                    |
| 9. Warm Springs Rd/BART<br>St S.W.S. North          | --                     |          | A (0.55)              |     | 50                     | 2.0      | No                 |
|                                                     | --                     |          | A (0.47)              |     | 46                     | 1.9      |                    |
| 10. Warm Springs Rd/<br>BART St S.W.S. SE           | --                     |          | D (0.82)              |     | 432                    | 15.2     | No                 |
|                                                     | --                     |          | B (0.65)              |     | 401                    | 14.6     |                    |
| 11. Kato Rd/BART St<br>S.W.S. South                 | --                     |          | A (0.53)              |     | 432                    | 29.1     | No                 |
|                                                     | --                     |          | A (0.36)              |     | 392                    | 59.9     |                    |

Note: For each intersection, LOS and V/C ratio is shown as AM peak hour on top of PM peak hour. Unsignalized one- and two-way stop controlled intersections are shown as the worst movement from the minor street followed by the worst movement from the major street (e.g. D/A). Unsignalized all-way stop controlled intersections are shown as either better than LOS C (<C) or worse than LOS C (>C).

\*BART generated traffic as a percent of total volume at intersection.

Source: DKS Associates, 1991.

proposed Irvington and South Warm Springs Stations. Table 3.12-37 shows the intersection analysis results for the year 2010 with Alternative 11.

**Table 3.12-37**  
**Summary of Intersection Traffic Analysis Results - Alternative 11**  
**Year 2010**

| Intersection                                  | W/out Proposed Project |          | With Proposed Project |     | BART-Generated Traffic |          | Significant Impact |
|-----------------------------------------------|------------------------|----------|-----------------------|-----|------------------------|----------|--------------------|
|                                               | LOS                    | V/C      | LOS                   | V/C | Amount                 | Percent* |                    |
| <i>Irvington</i>                              |                        |          |                       |     |                        |          |                    |
| 1. Fremont Bl/Bay St/<br>Washington Bl        | A.M.                   | F (1.03) | F (1.03)              |     | 58                     | 1.6      | Yes                |
|                                               | P.M.                   | F (1.05) | F (1.06)              |     | 53                     | 1.2      |                    |
| 2. Driscoll Rd-Osgood Rd/<br>Washington Bl    | A                      | (0.60)   | B (0.69)              |     | 207                    | 5.7      | No                 |
|                                               | C                      | (0.78)   | D (0.81)              |     | 188                    | 4.6      |                    |
| 3. I-680 SB Ramps/<br>Washington Bl           |                        | E/D      | E/D                   |     | 58                     | 2.1      | Yes                |
|                                               |                        | F/F      | F/F                   |     | 53                     | 1.8      |                    |
| 4. I-680 NB Ramps-Luzon/<br>Washington Bl     | C                      | (0.74)   | C (0.76)              |     | 56                     | 2.2      | No                 |
|                                               | C                      | (0.74)   | C (0.75)              |     | 51                     | 1.8      |                    |
| 5. Osgood Rd/Blacow Rd                        | A                      | (0.45)   | A (0.60)              |     | 324                    | 13.3     | No                 |
|                                               | A                      | (0.54)   | A (0.59)              |     | 295                    | 12.3     |                    |
| 6. Osgood Rd/BART St<br>Irvington             |                        | --       | A (0.47)              |     | 334                    | 22.4     | No                 |
|                                               |                        | --       | A (0.54)              |     | 315                    | 17.2     |                    |
| <i>South Warm Springs</i>                     |                        |          |                       |     |                        |          |                    |
| 1. Milmont Dr/<br>Kato Rd                     | C                      | (0.71)   | D (0.83)              |     | 372                    | 14.4     | No                 |
|                                               | A                      | (0.59)   | D (0.83)              |     | 340                    | 14.6     |                    |
| 2. Warm Springs Bl/<br>Kato Rd/Scott Creek Rd | E                      | (0.91)   | F (1.02)              |     | 568                    | 10.3     | Yes                |
|                                               | C                      | (0.72)   | C (0.79)              |     | 519                    | 12.3     |                    |
| 3. I-680 SB Ramps/<br>Scott Creek Rd          | A                      | (0.35)   | A (0.45)              |     | 461                    | 18.4     | No                 |
|                                               | A                      | (0.45)   | A (0.47)              |     | 420                    | 14.4     |                    |

Notes: For each intersection, LOS and V/C ratio is shown as AM peak hour on top of PM peak hour. Unsignalized one- and two-way stop controlled intersections are shown as the worst movement from the minor street followed by the worst movement from the major street (e.g. D/A). Unsignalized all-way stop controlled intersections are shown as either better than LOS C (<C) or worse than LOS C (>C).

Level of impact assumes implementation of improvements planned by City of Fremont or Milpitas.

\*BART generated traffic as a percent of total volume at intersection.

Source: DKS Associates, 1991.

**Table 3.12-37 (cont.)**  
**Summary of Intersection Traffic Analysis Results - Alternative 11**  
**Year 2010**

| Intersection                                        | W/out Proposed Project |        | With Proposed Project |        | BART-Generated Traffic |          | Significant Impact |
|-----------------------------------------------------|------------------------|--------|-----------------------|--------|------------------------|----------|--------------------|
|                                                     | LOS                    | V/C    | LOS                   | V/C    | Amount                 | Percent* |                    |
| <i>South Warm Springs (cont.)</i>                   |                        |        |                       |        |                        |          |                    |
| 4. I-680 NB Ramps/<br>Scott Creek Rd                | A.M.                   | A/A    |                       | A/A    | 368                    | 19.9     | No                 |
|                                                     | P.M.                   | A/A    |                       | A/A    | 208                    | 12.5     |                    |
| 5. N. Milpitas Bl/<br>Dixon Landing Rd              | F                      | (1.01) | F                     | (1.01) | 98                     | 2.7      | Yes                |
|                                                     | D                      | (0.88) | D                     | (0.90) | 89                     | 2.6      |                    |
| 6. Milmont Dr/<br>Dixon Landing Rd                  | F                      | (1.02) | F                     | (1.24) | 363                    | 10.0     | Yes                |
|                                                     | E                      | (0.97) | F                     | (1.07) | 331                    | 9.1      |                    |
| 7. I-880 NB Ramps-California<br>Cr/Dixon Landing Rd | E                      | (0.96) | F                     | (1.12) | 363                    | 6.6      | Yes                |
|                                                     | C                      | (0.78) | D                     | (0.81) | 331                    | 7.6      |                    |
| 8. I-880 SB Ramps/<br>Dixon Landing Rd              | A                      | (0.60) | B                     | (0.61) | 107                    | 2.9      | No                 |
|                                                     | A                      | (0.49) | A                     | (0.50) | 205                    | 5.1      |                    |
| 9. Warm Springs Rd/BART<br>St S.W.S. North          | -                      |        | A                     | (0.52) | 56                     | 2.0      | No                 |
|                                                     | -                      |        | A                     | (0.53) | 51                     | 2.1      |                    |
| 10. Warm Springs Rd/<br>BART St S.W.S. SE           | -                      |        | C                     | (0.79) | 485                    | 15.0     | No                 |
|                                                     | -                      |        | C                     | (0.80) | 453                    | 16.1     |                    |
| 11. Kato Rd/BART St<br>S.W.S. South                 | -                      |        | D                     | (0.81) | 485                    | 22.9     | No                 |
|                                                     | -                      |        | A                     | (0.47) | 443                    | 29.0     |                    |

Notes: For each intersection, LOS and V/C ratio is shown as AM peak hour on top of PM peak hour. Unsignalized one- and two-way stop controlled intersections are shown as the worst movement from the minor street followed by the worst movement from the major street (e.g. D/A). Unsignalized all-way stop controlled intersections are shown as either better than LOS C (<C) or worse than LOS C (>C).

Level of impact assumes implementation of improvements planned by City of Fremont or Milpitas.

\*BART generated traffic as a percent of total volume at intersection.

Source: DKS Associates, 1991.

**Parking.** Parking demand was estimated in the same way as for the Proposed Project. Table 3.12-38 shows estimated parking demand versus the amount to be provided at the station site. Parking supply would be adequate to meet parking demand at both extension stations and no significant impacts would occur.

#### Construction Period Impacts

Impacts are similar as for the Proposed Project except there is no construction in the vicinity of Warm Springs.

#### Mitigation Measures

Mitigation measures in the vicinity of Irvington and South Warm Springs Stations are the same as for the Proposed Project.

#### Residual Impacts After Mitigation

Residual impacts after mitigation are the same as the Proposed Project, except there are none in the vicinity of the Warm Springs Station.

### 3.12.13 REGIONAL TRAFFIC IMPLICATIONS

The MTC Regional Travel Model (Year 2010) indicated that regional travel by automobile is expected to increase by about 15.4 million average daily vehicle miles traveled (VMT) per day with the Proposed Project over existing conditions, primarily as a result of the increase in regional growth. This is a 17.5 percent increase in VMT over existing conditions.

Table 3.12-39 compares the regional VMT for existing conditions and the Proposed Project and alternatives for Year 2010. The Proposed Project and alternatives have relatively the same percentage increase in VMT over existing conditions. Alternatives 1 and 2 have greater increases than the Proposed Project since they have fewer transit improvements than the

**Table 3.12-38  
Adequacy of Parking Supply  
Alternative 11**

|                                       | Irvington<br>Station | South<br>Warm Springs<br>Station |
|---------------------------------------|----------------------|----------------------------------|
| Estimated Year 2010<br>Parking Demand | 1,110                | 2,430 <sup>1</sup>               |
| Approx. # of Stalls                   | 1,200                | 3,300                            |

<sup>1</sup> Includes parking demand for transportation service other than BART.

Source: DKS Associates, 1991

Note: Parking supply estimates are based on station concept drawings. As the stations are designed, the actual parking supply could change. BART plans to meet, as a minimum, the year 2010 parking demand.



**Table 3.12-39**  
**Comparison of Estimated Average Daily Vehicle Miles of Travel**  
**Proposed Project and Alternatives - Year 2010**

| Alternative                                                  | VMT<br>(Thousands) | Percent Change<br>Over Existing |
|--------------------------------------------------------------|--------------------|---------------------------------|
| Existing                                                     | 87,960             |                                 |
| Proposed Project                                             | 103,350            | +17.5%                          |
| Alt. 1 - Status Quo                                          | 105,955            | +20.5%                          |
| Alt. 2 - Planned Improvements                                | 104,557            | +18.9%                          |
| Alt. 3 - TSM                                                 | 103,363            | +17.5%                          |
| Alts. 4, 5: Irvington & Warm Springs Stations                | 103,361            | +17.5%                          |
| Alts. 6, 7, 8: Warm Springs &<br>South Warm Springs Stations | 103,358            | +17.5%                          |
| Alt. 9: Warm Springs Station                                 | 103,368            | +17.5%                          |
| Alt. 10: South Warm Springs Station                          | 103,368            | +17.5%                          |
| Alt. 11: Irvington and South Warm Springs Stations           | 103,350            | +17.5%                          |

VMT = Vehicle Miles of Travel

Source: DKS Associates adjustment of MTC travel forecasts.

Proposed Project. The TSM alternative (Alternative 3) has about the same percent increase over existing conditions as the Proposed Project. The implementation of the Proposed Project would decrease VMT by about 2,000 vehicles as compared to the TSM alternative.

## 3.13 NOISE AND VIBRATION

### 3.13.1 SETTING AND EXISTING CONDITIONS

The impact of noise on the local populace has been and continues to be a matter of concern to the City of Fremont and its residents. The community's sensitivity to the issue of noise impacts is linked to freight train activity on the SPTCo and UPRR tracks, and to traffic on nearby freeways I-880 and I-680. The noise element of Fremont's General Plan cites the need to reduce the impact of noise from these and other sources.

In most communities, common sources of groundborne vibration are surface vehicular traffic (e.g., trucks, buses) and, occasionally, large mechanical equipment. These are usually at low enough levels to be imperceptible. In Fremont, however, the presence of two railroad freight lines running alongside most of the proposed BART corridor currently exposes the surrounding inhabitants to significant and perceptible groundborne vibration.

The following is a discussion of the standards and criteria used to assess potential noise and vibration impacts of the Proposed Project. This includes information on existing noise and vibration levels, obtained by direct measurements within the project study area. Complete details concerning noise and vibration criteria, field survey procedures, and existing noise and vibration levels, are contained in the "Technical Report on Noise and Vibration" for the BART Warm Springs Extension, available for inspection from BART Extensions Planning.

#### Noise Criteria

The measure of corridor "wayside noise" impacts from a transit project provides a basis for determining the type and extent of noise reduction measures necessary to minimize annoyance in the community. Two types of criteria are traditionally applied to a noise impact evaluation of a rail transit project such as the proposed extension of BART. These two criteria consider different aspects of the noise emitted by transit system operation. The first, known as "absolute criteria," as specified by the American Public Transit Association (APTA),<sup>1</sup> is based on the "maximum passby noise level." Absolute criteria directly address the noise impact of the passing of a single train. (Absolute criteria also indirectly address cumulative exposure, since an "acceptable" noise level is a function of the frequency of train passbys, assuming typical transit operations.)

---

<sup>1</sup> *Guidelines for Design of Rapid Transit Facilities*, Report by American Public Transit Association (APTA), Section 2-7.6. January 1979.

The second type of evaluation criteria, known as "relative criteria," is based on relative change in the cumulative noise exposure. Guidelines for the use of relative criteria are given by the Urban Mass Transportation Administration (UMTA).<sup>1</sup> Relative criteria address the impact from exposure to numerous train passbys. A fuller discussion of both types of criteria is contained in the "Noise and Vibration Technical Report" for the BART Warm Springs Extension.

Table 3.13-1 indicates five general categories for the classification of communities along transit corridors. The prevailing land use type in each category is given, along with the normal range of ambient noise levels. (The classification of a specific site depends on the existing ambient noise as well as the actual land use.) These categories and their associated noise levels are based in part on information developed from studies of several rail transit corridor environments, along with data developed by the U.S. Environmental Protection Agency (EPA),<sup>2</sup> and other field data obtained in many community areas in North America.

#### Noise Terminology

**Ambient noise.** *Prevailing general noise existing in the surrounding area; in the case of this study, noise in the areas adjacent to the project alignment.*

**dBA.** *A measure of "noisiness" as perceived by the human ear. dBA is based on the decibel system, the traditional measure of noise level. Many public agencies, including the EPA and Caltrans, require the use of this measure in noise impact evaluations.*

**$L_{eq}$ .** *An average of noise levels (energy equivalent) at a location over time. The  $L_{eq}$  is considered a useful measure of an area's typical noise exposure over a long period of time, and usually is based on the dBA value.*

**$L_{dn}$ .** *A measure of day/night noise levels,  $L_{dn}$  is an extension of the  $L_{eq}$  but places greater emphasis on nighttime hours when people are typically at home. Noise levels between 10 P.M. and 7 A.M. are weighted to account for the greater intrusiveness of noise during nighttime hours.*

**$L_{50}$ .** *Noise level exceeded 50 percent of the time; a median measure based on the dBA value.*

**CNEL.** *The Community Noise Equivalent Level (CNEL). It is similar to  $L_{dn}$  and is used by several agencies in California.*

The five categories in the table are used to determine appropriate absolute noise and vibration impact criteria. Experience with several new transit systems now in operation, as well as extensions of older systems, has demonstrated that the application of these categories and their

<sup>1</sup> *Guidelines for Preparing Environmental Assessments*, Urban Mass Transportation Administration (UMTA), Publication C5620.1, Section D. October 16, 1979.

<sup>2</sup> *Information on Levels of Environmental Noise Requisite to Protect Public Health and Welfare with an Adequate Margin of Safety*, United States Environmental Protection Agency, EPA Technical Document 500/9-74-004, March 1974, usually referred to as the *Levels Document*.

**Table 3.13-1**  
**General Categories of Communities Along Rail System Corridors**

| Area Category | Area Description                                                                                                                              | Typical (Average or L <sub>50</sub> *) Ambient Noise Level-dBA | Typical Day/Night Exposure Levels-L <sub>dn</sub> |
|---------------|-----------------------------------------------------------------------------------------------------------------------------------------------|----------------------------------------------------------------|---------------------------------------------------|
| I             | <u>Low Density</u> urban residential, open space park, suburban residential or quiet recreation area. No nearby highways or boulevards.       | 40-50 - day<br>35-45 - night                                   | Below 55                                          |
| II            | <u>Average</u> urban residential, quiet apartments and hotels, open space, suburban residential, or occupied outdoor areas near busy streets. | 45-55 - day<br>40-50 - night                                   | 50-60                                             |
| III           | <u>High Density</u> urban residential, average semi-residential/ commercial areas, parks, museum, and non-commercial public building areas.   | 50-60 - day<br>45-55 - night                                   | 55-65                                             |
| IV            | <u>Commercial</u> areas with office buildings, retail stores, etc., primarily daytime occupancy. Central Business Districts.                  | 60-70                                                          | Over 60                                           |
| V             | <u>Industrial</u> areas or <u>Freeway</u> and <u>Highway Corridors</u> .                                                                      | Over 60                                                        | Over 65                                           |

\* L<sub>50</sub> is the long-term statistical median noise level.

Source: *Guidelines for Design of Rapid Transit Facilities*, APTA, January 1979.

criteria result in accurate identification of potential transit system noise impacts. This in turn allows the development of sufficient mitigation measures to ensure acceptable levels of noise for the neighbors of transit facilities.

**Federal Guidelines.** There are no Federal regulations that specify absolute levels of acceptable noise which apply directly to rail rapid transit systems. The U.S. Department of Transportation through UMTA has established guidelines that are useful in assessing potential noise impacts of rail transit.

The UMTA guidelines for relative criteria used in evaluating the significance of noise impacts are contained in *Guidelines for Preparing Environmental Assessments*. These guidelines apply to the relative change in airborne noise in terms of long term noise exposure. This exposure is expressed in terms of the average "energy equivalent" noise levels ( $L_{eq}$ ). The  $L_{eq}$  noise level may be given for different time periods depending on the nature of the project and the period during which most transit activity takes place.

The UMTA guidelines for relative criteria indicate that noise impacts are generally not significant if no "noise-sensitive" sites are located in the project area. Impacts also are not considered significant if the  $L_{eq}$  increases caused by the Proposed Project are projected to be 3 dBA or less at noise-sensitive locations, and if the Proposed Project will not result in violations of local noise ordinances or standards.

Where there is nighttime occupancy along the alignment, (e.g., residential areas) and the transit system operates during this time, the day/night noise level measure ( $L_{dn}$ ) should be used. Day/night noise-sensitive sites include residences, motels, hotels, public meeting rooms, auditoriums, schools, churches, libraries, hospitals, amphitheaters, parks, and other areas where quiet is essential. "Active" parks, such as ballfields are not generally defined as noise-sensitive areas because their use and enjoyment are not precluded by moderate noise levels.

If the increase in noise is greater than 3 dBA, the significance of impact will depend on the ambient noise level. Noise impacts are possibly significant if increases in noise exposure levels are expected to be no greater than 5 dBA with implementation of the project. Specific increases in noise exposure become more significant at higher ambient noise levels. An increase in noise exposure levels of 6 dBA or greater is considered to be generally significant.

**APTA Guidelines.** The APTA guidelines for absolute criteria can be used for evaluations of both airborne and groundborne noise in transit corridor communities. These guidelines

recommend maximum passby noise levels, i.e., the maximum noise level which occurs during an individual train passby, or which occurs from ancillary facilities associated with the transit system, such as a carwashing facility or maintenance yard. These guidelines (presented in Tables 3.13-2 through 3.13-6) are based on absolute criteria for single events and relate directly to the five area-type categories defined in Table 3.13-1. A maximum single-event (i.e., individual "passby") noise level refers to the average level which occurs during a train passby.

**Table 3.13-2**  
**APTA Guidelines for Maximum Airborne Noise from Train Operations\***

| Community Area<br>Category   | --- Maximum Single Passby Noise Level --- |                               |                         |
|------------------------------|-------------------------------------------|-------------------------------|-------------------------|
|                              | Single<br>Family<br>Dwellings             | Multi-<br>Family<br>Dwellings | Commercial<br>Buildings |
| I Low Density Residential    | 70 dBA                                    | 75 dBA                        | 80 dBA                  |
| II Average Residential       | 75                                        | 75                            | 80                      |
| III High Density Residential | 75                                        | 80                            | 85                      |
| IV Commercial                | 80                                        | 80                            | 85                      |
| V Industrial/Highway         | 80                                        | 85                            | 85                      |

\* These criteria are generally applicable at the near side of the nearest dwelling or occupied building under consideration or at 50 ft from the track centerline, whichever is closer.

Source: *Guidelines for Design of Rapid Transit Facilities*, APTA, January 1979.

Classification of community areas is dependent in part on the median ambient noise level. This is expressed as  $L_{50}$ , the noise level exceeded 50 percent of the time. Typical  $L_{50}$  values for each of the community area categories are shown in Table 3.13-1, as are the typical  $L_{dn}$  values for these areas.

The APTA guidelines, as shown in Tables 3.13-5 and 3.13-6, also contain criteria for evaluation of groundborne noise. Groundborne noise is only significant for segments of an alignment that are underground, or subway.

**Table 3.13-3****APTA Guidelines for Maximum Airborne Noise from Train Operations Near Specific Types of Buildings\***

| Building or Occupancy Type                                 | Maximum Single Passby Noise Level |
|------------------------------------------------------------|-----------------------------------|
| Amphitheatres                                              | 65 dBA                            |
| "Quiet" Outdoor Recreation Areas                           | 70 dBA                            |
| Concert Hall, Radio and TV Studios                         | 70 dBA                            |
| Churches, Theatres, Schools, Hospitals, Museums, Libraries | 75 dBA                            |

\*These criteria are generally applicable at the nearside of the nearest dwelling or occupied building under consideration or at 50 ft from the track centerline, whichever is closer.

Source: *Guidelines for Design of Rapid Transit Facilities*, APTA, January 1979.

**Table 3.13-4****APTA Guidelines for Noise from Substations\***

| Community Area Category      | Maximum Noise Level Design Goal |
|------------------------------|---------------------------------|
| I Low Density Residential    | 35 dBA                          |
| II Average Residential       | 40                              |
| III High Density Residential | 45                              |
| IV Commercial                | 50                              |
| V Industrial/Highway         | 60                              |

\*The design goal noise levels should be applied at 50 ft from the substation or should be applied at the setback line of the nearest buildings or occupied area, whichever is closer.

Source: *Guidelines for Design of Rapid Transit Facilities*, APTA, January 1979.

**Table 3.13-5****Criteria for Maximum Groundborne Noise from Train Operations**

| Community Area<br>Category   | ---- Maximum Single Passby Noise Level ---- |                               |                              |
|------------------------------|---------------------------------------------|-------------------------------|------------------------------|
|                              | Single<br>Family<br>Dwellings               | Multi-<br>Family<br>Dwellings | Hotel/<br>Motel<br>Dwellings |
| I Low Density Residential    | 30 dBA                                      | 35 dBA                        | 40 dBA                       |
| II Average Residential       | 35                                          | 40                            | 45                           |
| III High Density Residential | 35                                          | 40                            | 45                           |
| IV Commercial                | 40                                          | 45                            | 50                           |
| V Industrial/Highway         | 40                                          | 45                            | 50                           |

Source: *Guidelines for Design of Rapid Transit Facilities*, APTA, January 1979.

**Table 3.13-6****Criteria for Maximum Groundborne Noise from Train Operations Near Specific Types of Buildings**

| Type of Building or Room    | Maximum Single Passby<br>Noise Level |
|-----------------------------|--------------------------------------|
| Concert Hall and TV Studios | 25 dBA                               |
| Auditoriums and Music Rooms | 30                                   |
| Churches and Theatres       | 35                                   |
| Hospital Sleeping Rooms     | 35-40                                |
| Courtrooms                  | 35                                   |
| Schools and Libraries       | 40                                   |
| University Buildings        | 35-40                                |
| Offices                     | 35-45                                |
| Commercial Buildings        | 45-55                                |

Source: *Guidelines for Design of Rapid Transit Facilities*, APTA, January 1979.



**State and Local Guidelines.** The State of California has enacted regulations intended to control community noise in general; however, none of these regulations explicitly applies to the control of noise emission from rail rapid transit systems.

The proposed alignments are all within the City of Fremont, which has complied with the requirements of the California Government Code Section 65302(g) by adopting a noise element of the General Plan. The City of Fremont's General Plan Noise Element, adopted May 7, 1991, contains general noise exposure goals and guidelines to be used by the planning department when considering the compatibility of proposed residential developments with an existing noise environment. The guidelines do not apply directly to the control of noise from transit vehicle operations, but they can be considered to be goals, and indicate the community's opinion concerning noise.

Fremont's General Plan Noise Element considers a CNEL of 60 dBA or less to be a "normally acceptable", 65 to 75 dBA to be a "normally unacceptable", and above 75 dBA to be a "clearly unacceptable" environment for residential land use. School, hospital and park land use is "conditionally acceptable" for CNEL between 60 and 70 dBA, but otherwise the same as residential guidelines.

The City of Fremont has a noise control ordinance in its municipal code. The noise control standards apply to fixed noise sources; excluded from these standards are sounds generated by the movement of railroad equipment, or temporary construction activity. Consequently, the noise standards are not applicable to the evaluation of noise impact from transit trains.

In conclusion, review of the pertinent state and local standards and ordinances indicate the UMTA and APTA guidelines to be appropriate and sufficient criteria for evaluating noise impact from the proposed BART Warm Springs Extension.

#### **Vibration Criteria**

The criteria for controlling groundborne vibration, based on the overall vibration velocity level, have been developed through the experiences of modern rail rapid transit systems in North America. These criteria were originally developed to assess the need for vibration-reduction measures on existing rapid transit systems, and in the design phases of extension projects. For transit systems such as Atlanta (MARTA), Washington D.C. (WMATA), Chicago (CTA), and Baltimore (BRRT), the application of these criteria for new rail transit systems and extensions

of existing systems have successfully avoided significant groundborne vibration impacts, particularly vibration which can be perceived by humans.

Table 3.13-7 presents the appropriate criteria for the maximum groundborne vibration for various types of residential buildings. The criteria apply to the vertical vibration of floor surfaces within a building, and are expressed in terms of the vibration velocity level in decibels (dB re: 1 micro in/sec).<sup>1</sup> The vibration criteria in Table 3.13-7 are based on the same five area-type categories given in Table 3.13-1. As with noise criteria, there are some types of buildings for which the criteria is independent of the community area category. Table 3.13-8 presents criteria based on extensive experience at other rail rapid transit systems for generally acceptable levels of transient groundborne vibration in various types of non-residential buildings.

Groundborne vibration which complies with these criteria will not necessarily be imperceptible in all instances; however, the level will be sufficiently low so that no significant intrusion or annoyance should occur.

#### **Existing Ambient Noise and Vibration**

There are several major noise sources within the study area. A principal source of noise throughout the corridor is motor vehicles, which is typical of a suburban environment. This applies to all portions of the rail alternative alignments. Beyond Central Park, where the Proposed Project alignment would be parallel to the existing SPTCo and UPRR tracks, a moderate number of freight trains (typically five to seven) pass by daily. Given the abundance of existing noise sources, most areas of the community directly adjacent to the Proposed Project alignment are exposed to relatively high levels of ambient noise. While all the other "build" alternatives follow the same general route as the Proposed Project, the alignment for Alternative 8 follows Osgood Road, which subsequently becomes Warm Springs Boulevard. This roadway is a heavily travelled thoroughfare with moderately high noise levels.

To establish a baseline of representative community noise and vibration data for the corridor study area, ambient noise and vibration measurements were made outside representative buildings and in representative areas adjacent to the Proposed Project alignment. The determination of the appropriate levels of noise and vibration that can be emitted by the proposed transit service and produce no significant impact are based in part on this characterization.

---

<sup>1</sup> micro in/sec =  $10^{-6}$  in/sec

**Table 3.13-7****Recommended Guidelines for Maximum Groundborne Vibration from Train Operations\***

| Community Area<br>Category   | Maximum Single Passby Groundborne<br>Vibration Velocity Level<br>----- (dB re micro in/sec) ----- |                               |                              |
|------------------------------|---------------------------------------------------------------------------------------------------|-------------------------------|------------------------------|
|                              | Single<br>Family<br>Dwellings                                                                     | Multi-<br>Family<br>Dwellings | Hotel/<br>Motel<br>Buildings |
| I Low Density Residential    | 70                                                                                                | 70                            | 70                           |
| II Average Residential       | 70                                                                                                | 70                            | 75                           |
| III High Density Residential | 70                                                                                                | 75                            | 75                           |
| IV Commercial                | 70                                                                                                | 75                            | 75                           |
| V Industrial/Highway         | 75                                                                                                | 75                            | 75                           |

\*Criteria apply to the vertical vibration of floor surfaces within the buildings.

Source: *American Public Transit Association, 1979.*

**Table 3.13-8****Recommended Guidelines for Maximum Groundborne Vibration from Train Operations\***

| Type of Building or Room                                 | Maximum Single Passby<br>Vibration Velocity Level<br>(dB re micro in/sec) |
|----------------------------------------------------------|---------------------------------------------------------------------------|
| Concert Halls and TV Studios                             | 65                                                                        |
| Auditoriums and Music Rooms                              | 70                                                                        |
| Churches and Theatres                                    | 70-75                                                                     |
| Hospital Sleeping Rooms                                  | 70-75                                                                     |
| Courtrooms                                               | 75                                                                        |
| Schools and Libraries                                    | 75                                                                        |
| University Buildings                                     | 75-80                                                                     |
| Offices                                                  | 75-80                                                                     |
| Commercial & Industrial Buildings                        | 75-85                                                                     |
| Vibration Sensitive Industrial or<br>Research Laboratory | 60-70                                                                     |

\*Criteria apply to the vertical vibration of floor surfaces within the buildings.

Source: *American Public Transit Association, 1979.*

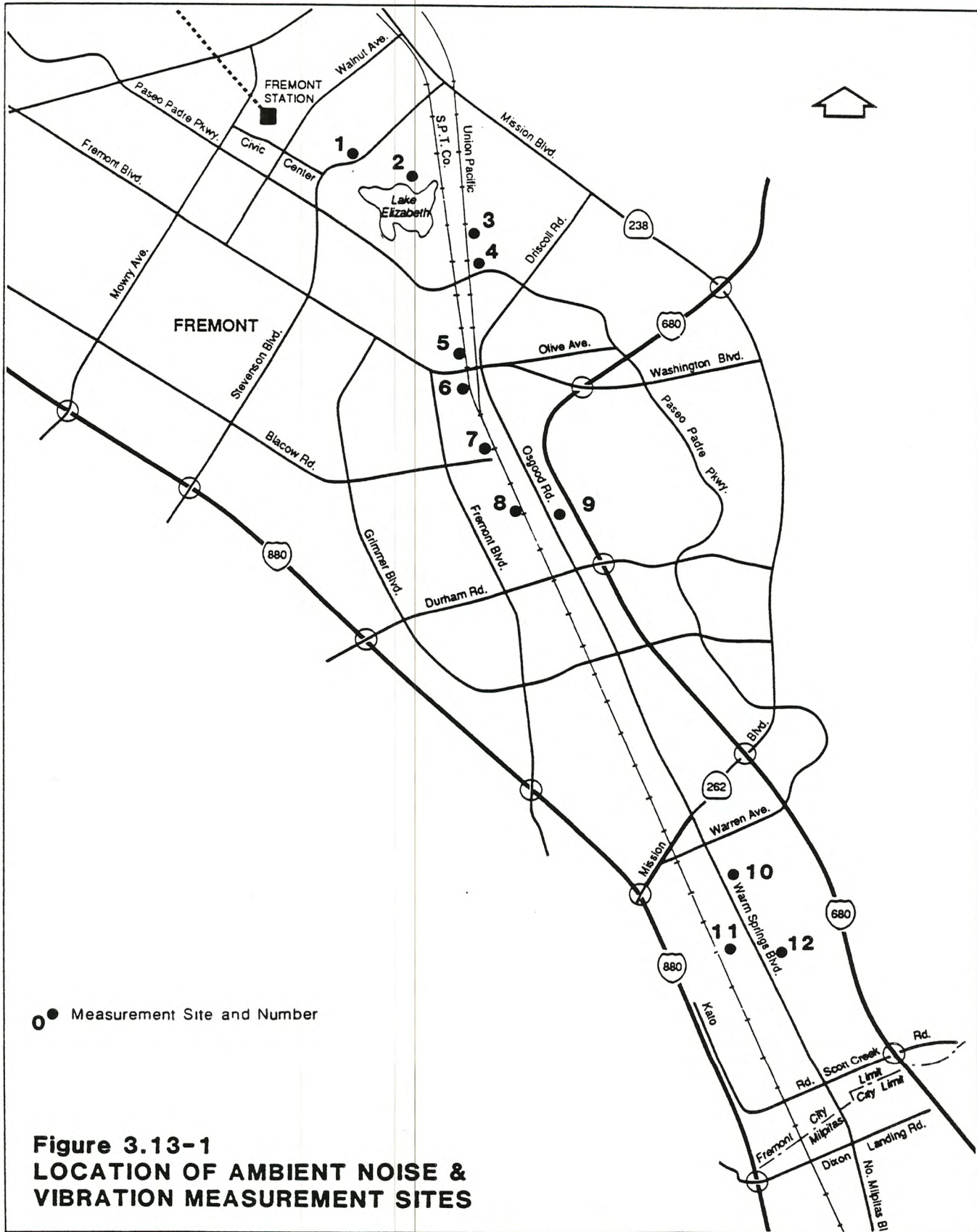
Twelve measurement sites were chosen to characterize the ambient noise and vibration levels within the corridor study area. They were selected to represent noise-sensitive land uses, maximum expected impacts from the project alignments, and maximum geographical coverage of the study area. Figure 3.13-1 indicates the location of the noise and vibration measurement sites. Table 3.13-9 lists the measurement sites and gives a description of the surrounding land use as well as the existing major noise sources affecting each site.

Short term noise and vibration measurements were made at eleven locations, and 24-hour (long term) noise measurements were made at all of the sites in order to obtain a complete statistical representation of the existing daily noise environment. Long term noise measurements were made in 1987 at sites 1, 4, 6 and 7 in conjunction with the previous DEIR. New measurements were made at site 1 in conjunction with this study to verify the previous measurements.

**Existing Noise Environment.** The results of the noise survey are presented in Table 3.13-10. All references in Table 3.13-10 and in the following descriptions are keyed to the measurement site designations shown in Figure 3.13-1. Much of the proposed extension would pass through land with noise-sensitive receptors (e.g., parkland residential), although there are portions south of Washington Boulevard and north of Mission Boulevard which are principally commercial or agricultural.

South of the existing Fremont Station are three multi-family residence complexes (Fremont Villas, Sun Pointe and Mission Wells). Fremont Villas are located closest to the Proposed Project alignment; current noise levels for the Fremont Villas is measured at  $L_{dn}$  57 dBA, with the major source being traffic along Stevenson Boulevard. This noise level is acceptable for residential land use according to Fremont's General Plan Noise Element; according to the APTA Guidelines, this area can be classified as Category II (average residential).

In Central Park, the main source of transit noise impact would be to park users at the softball and soccer fields and in the area around Lake Elizabeth. The major existing sources of noise affecting Central Park are the motor vehicles on Stevenson Boulevard and the freight trains on the UPRR and SPTCo tracks, with frequent small aircraft at times. At the baseball diamonds, the day time  $L_{dn}$  is 58 dBA, which can be assumed to be representative for this area of the park. The existing noise level is compatible with a park-like environment and acceptable according to the General Plan Noise Element guidelines. This area of Central Park can be classified as Category II. Closer to the railroad tracks the noise level is higher. At the northeast corner of Lake Elizabeth, which is approximately 400 feet from the SPTCo tracks, the  $L_{dn}$  is estimated to be 64 to 66 dBA, based on other field measurements for this study.



Source: Wilson Ihrig, 1991

**Table 3.13-9  
Description of Ambient Noise and Vibration Measurement Sites**

| Site Number      | Closest Receptor                                             | Surrounding Land Use        | Major Existing Noise and Vibration Sources             | Approximate Distance of Source (ft) |
|------------------|--------------------------------------------------------------|-----------------------------|--------------------------------------------------------|-------------------------------------|
| 1 <sup>(1)</sup> | Fremont Villas                                               | Residential/<br>Park        | Stevenson Blvd. (N&V)<br>SPTCo (N)                     | 300<br>3000                         |
| 2                | Softball Field<br>in Central Park                            | Park                        | Stevenson Blvd. (N&V)<br>SPTCo (N)<br>UPRR (N)         | 800<br>1400<br>2200                 |
| 3                | 1621 Valdez                                                  | Residential                 | SPTCo (N&V)<br>UPRR (N&V)                              | 675*<br>80*                         |
| 4 <sup>(1)</sup> | 40779 Vaca Dr.                                               | Residential                 | SPTCo (N)<br>UPRR (N&V)<br>Paseo Padre Pkwy. (N)       | 620*<br>90*<br>570*                 |
| 5                | 3224 & 3232<br>Neal Terrace                                  | Multi-Family<br>Residential | SPTCo (N&V)<br>UPRR (N&V)<br>Washington Blvd. (N&V)    | 50<br>400<br>1400                   |
| 6 <sup>(1)</sup> | Apartments south of<br>Washington Blvd,<br>west of alignment | Residential/<br>Commercial  | SPTCo (N&V)<br>UPRR (N&V)<br>Washington Blvd. (N)      | 60<br>350<br>250                    |
| 7 <sup>(1)</sup> | Homes at end of<br>Blacow Rd.                                | Residential                 | SPTCo (N&V)<br>UPRR (N&V)                              | 50<br>100                           |
| 8                | Grimmer Elementary<br>School                                 | Residential                 | SPTCo (N&V)<br>UPRR (N&V)<br>I-680 (N&V)               | 50<br>100<br>1400                   |
| 9                | 42950 Osgood Rd.                                             | Commercial                  | SPTCo (N)<br>UPRR (N)<br>I-680 (N)<br>Osgood Rd. (N&V) | 730<br>670<br>420*<br>13            |

*continued*

**Table 3.13-9 (Continued)**  
**Description of Ambient Noise and Vibration Measurement Sites**

| Site Number | Closest Receptor               | Surrounding Land Use | Major Existing Noise and Vibration Sources | Approximate Distance of Source (ft) |
|-------------|--------------------------------|----------------------|--------------------------------------------|-------------------------------------|
| 10          | Hackamore & Warm Springs Blvd. | Residential          | Warm Springs Blvd. (N&V)                   | 17                                  |
| 11          | 47671 Westinghouse Drive       | Industrial           | SPTCo (N&V)<br>UPRR (N&V)<br>I-880 (N)     | 200<br>100<br>1800                  |
| 12          | 101 Camphor                    | Residential          | Warm Springs Blvd. (N&V)                   | 25                                  |

N: Noise

V: Vibration

\*: Partially shielded from noise source

(1): Measurement sites from previous study for BART WSX DEIR

Source: Wilson, Ihrig & Associates, Inc., *BART Warm Springs Extension Technical Report on Noise and Vibration*, 1991.

**Table 3.13-10**  
**Ambient Noise and Vibration Levels Measured in December 1990**  
**at Locations Along the BART Warm Springs Extension**

| Site Number      | Closest Receptor               | ---- Airborne Noise ----     |                              |                       | APTA Criteria Area Category <sup>(1)</sup> | Ground Vibration                   |
|------------------|--------------------------------|------------------------------|------------------------------|-----------------------|--------------------------------------------|------------------------------------|
|                  |                                | L <sub>eq</sub> (peak) (dBA) | L <sub>50</sub> (dBA)        | L <sub>dn</sub> (dBA) |                                            | L <sub>1</sub> <sup>(2)</sup> (dB) |
| 1                | Fremont Villas                 | 56                           | 44-54 - day<br>31-53 - night | 57                    | II                                         | 39                                 |
| 2                | Central Park                   | 55                           | 45-54 - day<br>38-54 - night | 58                    | II                                         | 50-57                              |
| 3                | 1621 Valdez                    | 67                           | 45-57 - day<br>35-50 - night | 63 <sup>(5,6)</sup>   | III                                        | 35<br>74 <sup>(3)</sup>            |
| 4 <sup>(4)</sup> | 40779 Vaca Dr.                 | 68                           | N/A                          | 65 <sup>(5,6)</sup>   | III                                        | 37                                 |
| 5                | 3224 & 3232 Neal Terrace       | 76                           | 42-49 - day<br>33-48 - night | 72                    | V                                          | 34                                 |
| 6 <sup>(4)</sup> | Apts. South of Washington      | 75                           | N/A                          | 76                    | V                                          | 43                                 |
| 7 <sup>(4)</sup> | Homes at end of Blacow Rd.     | 80                           | N/A                          | 78                    | V                                          | 39<br>68-79 <sup>(3)</sup>         |
| 8                | Grimmer Elem. School           | 73                           | 45-65 - day<br>43-62 - night | 72 <sup>(6)</sup>     | V                                          | 36<br>72-77 <sup>(3)</sup>         |
| 9                | 42950 Osgood Rd.               | 70                           | 62-68 - day<br>54-66 - night | 72                    | IV                                         | 64                                 |
| 10               | Hackamore & Warm Springs Blvd. | 72                           | 64-70 - day<br>46-66 - night | 69                    | IV                                         | 55-64                              |
| 11               | 47641 Westinghouse Dr.         | 71                           | 50-68 - day<br>45-66 - night | 66                    | V                                          | N/A<br>75-80 <sup>(6)</sup>        |

*continued*



**Table 3.13-10 (Continued)**  
**Ambient Noise and Vibration Levels Measured in December 1990**  
**at Locations Along the BART Warm Springs Extension**

| Site Number | Closest Receptor | ---- Airborne Noise ----     |                              |                       | APTA Criteria Area Category <sup>(1)</sup> | Ground Vibration                   |
|-------------|------------------|------------------------------|------------------------------|-----------------------|--------------------------------------------|------------------------------------|
|             |                  | L <sub>eq</sub> (peak) (dBA) | L <sub>50</sub> (dBA)        | L <sub>dn</sub> (dBA) |                                            | L <sub>1</sub> <sup>(2)</sup> (dB) |
| 12          | 101 Camphor      | 70                           | 55-67 - day<br>42-62 - night | 65                    | III                                        | 59-67                              |

(1) Refer to Table 3.13-1, General Categories of Communities Along Rail System Corridors

(2) Based on 10-minute sample

(3) Passby vibration levels based on measurements for individual freight train

(4) Measurement sites from previous study for BART WSX DEIR; values taken from measurements by others as indicated in Table 3.7-2 of previous DEIR

(5) Measured behind existing sound barrier wall

(6) Projected level

L<sub>50</sub>: Noise level exceeded 50% of time (median level)

L<sub>1</sub>: Vibration level exceeded 1% of time (infrequent peak)

N/A: Not available

Source: Wilson, Ihrig & Associates, *BART Warm Springs Extension Technical Report on Noise and Vibration*, 1991.

Between Lake Elizabeth and Paseo Padre Parkway, the main potential for noise impact would be to the residences along the eastern side of the project alignment, and to visitors in the easternmost part of Central Park. The major current sources of noise for this area are freight trains on the SPTCo and UPRR tracks and traffic along Paseo Padre Parkway. The residences are generally 50 to 80 feet away from one of the freight tracks, and some are shielded from freight train noise by a sound barrier wall. At this distance, the  $L_{dn}$  is 63 dBA in the backyards of homes on Valdez Way (site No. 3). For residences closer to Paseo Padre Parkway (site No. 4) the  $L_{dn}$  is approximately 65 dBA in the backyards. According to Fremont's General Plan Noise Element guidelines, this area is normally unacceptable for residential land use. Based on the existing ambient noise levels, the area is consistent with Category III classification.

South of Paseo Padre Parkway, for the rest of the Proposed Project corridor, freight train activity is significant enough on the SPTCo and UPRR tracks to result in moderate to high levels of ambient noise at receptors between 150 and 50 feet from the nearest tracks, respectively. The area is primarily residential at the northern end and almost exclusively industrial on the southern end. The presence of the freight trains makes this segment an existing major transportation corridor. Because the area is a major existing transportation corridor with high ambient noise, it can be classified as Category V (industrial/highway).

At Washington Boulevard, the land use changes from exclusively residential to a mixture of residential and commercial/industrial. From about 1,800 feet north to about 1,000 feet south of Washington Boulevard, the main potential for noise impact would be the residences along the railroad right-of-way. There are two churches along Driscoll Road, which are approximately 300 feet from the UPRR tracks. Major sources of noise in this area are freight trains, motor vehicles, and industrial activity. The residences are about 50 to 80 feet away from one or the other railroad tracks. Measurement site No. 5 is about 1,400 feet north of Washington Boulevard; the  $L_{dn}$  at the site is 72 dBA. For residences and offices located within 200 feet south and north of Washington Boulevard (site No. 6) the  $L_{dn}$  is 76 dBA. These noise exposure levels exceed the City of Fremont Noise Element guideline for acceptable residential land use.

South of Washington Boulevard to Durham Road, the buildings east of the alignment are of industrial/commercial use; the buildings to the west are residential. There is a church about 200 feet from the rail tracks, and Grimmer Elementary School classrooms are about 300 feet from the tracks. Major current sources of noise are freight trains and motor vehicles. Measurements made for the previous DEIR at site No. 7 (approximately 100 feet from the rail tracks) indicate the  $L_{dn}$  to be 78 dBA; most of the houses are 80 to 100 feet from the tracks. Based on other

### Section 3.13 Noise and Vibration

measurements adjacent to the railroad right-of-way, this particular level appears to be too high and probably unrepresentative. Noise levels at Grimmer Elementary School (site No. 8) include noise created by the school children playing on the school grounds nearby; the  $L_{dn}$  in this area is 72 dBA, a level which is normally unacceptable for residential, school or park use based on the General Plan Noise Element guidelines.

From Durham to 2000 feet south of Grimmer Road, the building use is commercial/industrial, with a few isolated farm houses located near the tracks on either side of Grimmer Road. The main potential for noise impact would be at the farm houses, since they are occupied at night. The major existing sources of noise are freight trains and freeway traffic.

South of the farm houses, past Mission Boulevard until south of E. Warren Avenue, the main potential for noise impact would be at the commercial/industrial buildings east of the alignment. There are two motels within 1,000 feet of the alignment, one along Mission Boulevard and the other along East Warren Avenue, but the office and industrial buildings east of the alignment are 50 to 100 feet away. The major existing sources of noise are freight trains, traffic on I-680 and I-880, and traffic along Mission Boulevard. Traffic along Mission Boulevard is high because it serves as a connector between the two freeways. Measurements made at Site No. 11 indicate the peak hour  $L_{eq}$  in this region to be 71 dBA.

South of East Warren Avenue to the city and county line, the main potential for noise impact would be at several industrial/business parks. The major existing source of noise here is the freight trains, since the significance of I-680 and I-880 is diminished with the loss of sight lines.

**Freight Train Activity.** Measurements were also made to specifically characterize the noise and vibration levels emitted by freight trains in the corridor. These measurements were made in residential areas at Site Nos. 3, 7 and 8. Approximately six freight trains per day pass through the corridor. The trains have no fixed schedule but tend to operate between the hours of 6 A.M. and 7 P.M., with an occasional train outside this time span. Train speeds along the corridor vary considerably, depending on the train, its activity and its location. During some measurements, the train speeds were considerably reduced (to 5 to 10 mph) because of track repairs in the area.

At slower speeds (i.e., 10 mph or less) train passby noise levels were approximately 74 dBA for the locomotive, and 63 dBA for the cars at 80 feet from the UPRR tracks at Site No. 3, which is shielded by a sound barrier wall. At somewhat higher speeds (20 to 35 mph) and unshielded by a sound barrier wall, the passby noise levels were 82 dBA at 40 feet from the SPTCo tracks

at Site No. 8 and 86 dBA at 50 feet from the SPTCo tracks at Site No. 7. The duration of the train passby can last anywhere from several seconds to a few minutes depending on the length and speed of the train. The freight trains in this area varied in length from 13 to 98 cars with an average of 40 cars per train during the measurements. At an average speed of 40 mph, the passby duration is approximately one minute for trains of average length.

**Setting on Alternative 8 alignment.** Alternative 8 runs on an aerial structure down the middle of Osgood Road/Warm Springs Boulevard. From Washington Boulevard to Durham Road, the west side of the alignment is almost exclusively industrial/commercial, and the east side is mostly commercial, with several residences scattered along the alignment. The greatest potential for transit noise impact would be at these residences, which would be about 50 feet from the alignment. The major current source of noise in the area is freight trains (noise from this source is somewhat shielded by buildings to the west), and I-680 which curves to within 500 feet of the alignment. At site No. 9 the  $L_{dn}$  is 72 dBA, a level normally unacceptable for residential use based on the General Plan Noise Element guidelines; however, the area can be classified as Category IV (commercial) due to the presence of commercial establishments.

Between Durham Road and Mission Boulevard, land use is primarily commercial and industrial, with some retail buildings just north of Mission Boulevard. These buildings, located approximately 50 to 100 feet from the alignment, are not particularly noise sensitive but would be the main receptors affected by noise. The major existing noise here is traffic and freight trains. This area is Category IV (commercial), based on the land use.

Along Warm Springs Boulevard for just over a mile, south of Mission Boulevard, there are a few more retail buildings, a motel, and then mostly residences on the east and office/light manufacturing on the west. The major potential for noise impact would be to the residences along Warm Springs Boulevard. The major existing noise sources here are traffic along Warm Springs Boulevard, some freight train noise, and some traffic noise from I-680 and I-880. For the section closer to Warm Springs, the  $L_{dn}$  is 69 dBA at site No. 10, which is a level unacceptable for residential use based on the General Plan Noise Element guidelines. The area can be classified as Category IV (commercial) based on the land use and the ambient noise level. At site No. 12 further along the alignment, the  $L_{dn}$  is 65 dBA, a level which is normally unacceptable for residential use according to the General Plan Noise Element. Although this area is a mixture of single family residences on the east side of Warm Springs Boulevard and light industry on the west side, it can be classified as Category III (high density residential) rather than Category IV (commercial) based on the ambient noise level.

The last 2,000 feet of this alternative alignment bends westward back to the existing rail tracks, and runs through a business park. The office buildings nearby would be the most affected by noise. Major noise sources in this area are traffic on Warm Springs Boulevard, freight trains and I-880. The area can be classified as Category IV (commercial).

#### **Existing Vibration Environment.**

Existing exterior vibration sources within the corridor include automobiles, trucks, buses and trains. The vibration level data were measured at the same time and place as the short-term sound level data and were analyzed to obtain a single-number (i.e., overall), unweighted velocity level in decibels (dB re: 1 micro in/sec). Based on studies performed directly relating to groundborne vibration from rail transit systems, overall vibration velocity levels below approximately 70 dB are normally imperceptible to the average person inside a building. It is common for locations with the highest exterior noise levels to have the highest exterior vibration levels. The results of the vibration survey are presented in Table 3.13-10. Highlights of the survey are summarized in the following discussion, where all references are keyed to the measurement sites indicated in Figure

3.13-1. Vibration sensitive receptors within the corridor are, except for Central Park, the same as the noise sensitive receptors listed in Table 3.13-9. Vibration levels from transit operations are not of sufficient magnitude to disrupt outdoor activities.

#### **Transit System Noise Characteristics**

*Noise levels from operation of rail systems depend on several factors, including the distance of a receiver from the tracks, vehicle speed, type of track structure, train length, and the frequency of passbys. Other factors that can directly affect transit noise levels are barriers which shield the transit noise sources and thereby lower wayside noise levels. The total (cumulative) noise environment is a combination of ambient noise plus operational noise from the transit vehicles.*

*For surface and aerial installations, one of the most important design features of the modern rail system is continuous welded rail, which allows quieter operation when used in conjunction with noise reduction features included on the train cars. Continuous welded rail eliminates the rail joint, a major source of noise in older steel wheel/rail systems. Existing BART track uses continuous welded rail as do most modern transit systems.*

*For the purpose of assessing the environmental impact of proposed rail alignments, it is usually sufficient to assume level terrain for the surrounding community and generally ignore any existing sound barrier walls between the rail alignment and noise-sensitive receptors. However, where the BART tracks or relocated railroad tracks would be substantially depressed below grade, the effect of noise shielding is included in the projection of wayside noise.*

*The significance of impact is based on the existing ambient noise level, projected increase in ambient noise associated with the No-Action Alternative, the land use, and the level of train noise. In general, the higher the ambient noise level, the smaller the change necessary to cause a significant impact.*

Vibration levels measured for portions of the corridor at a distance removed from motor vehicle traffic and without freight train activity were an  $L_1$ , which corresponds to infrequently occurring peaks, of 35 dB. Closer to traffic the ambient vibration ranged from 50 dB to 67 dB. These levels indicate that, aside from freight train activity, groundborne vibration is below the threshold of perception (70 dB) throughout the entire corridor. In general, although not perceptible, the measured vibration levels are just below the threshold of perception in areas with heavily travelled streets and reflect the presence of trucks and trains.

Measurements specifically of groundborne vibration from freight train passbys are also indicated in Table 3.13-10 for sites No. 3, 4, 7, 8 and 11. The levels shown are representative of vibration from freight trains moving at moderate speeds (i.e., 20 to 35 mph) for the receptors in this area of the corridor adjacent to the SPTCo or UPRR tracks, which are from 40 to 80 feet away from numerous residences. The groundborne vibration level from trains is dependent mainly on the train speed and local soil conditions, but also on the condition of the rails and train wheels. The vibration level during train passbys at the measurement sites ranged from 68 to 80 dB for the trains. The existing groundborne vibration from the existing freight activity at these speeds and especially at higher speeds, should be perceptible to many of the residents living along the railroad right-of-way.

### 3.13.2 IMPACTS OF PROPOSED PROJECT

The noise and vibration impact analysis is based on a comparison of the impact of the Proposed Project with existing conditions.

#### Operational Wayside Noise Impacts

The Proposed Project and Alternatives 4, 7 and 8 are substantially different from each other; a summary of projected wayside noise levels at selected locations is presented for each. The other four build alternatives are basically variations of the above four alignments, and consequently it is not necessary to present separate wayside noise levels for each of these other alternatives. Differences in the Central Park design options are also presented.

Predictions of wayside noise are based on measured data from the existing BART rapid rail system and the methodology presented in the *Handbook of Urban Rail Noise and Vibration Control*.<sup>1</sup>

---

<sup>1</sup> Handbook of Urban Rail Noise and Vibration Control (UMTA-MA-06-0099-82-1), Wilson, Ihrig & Associates, 1982

**Criteria for Assessing Impact.** Both the APTA (absolute) and the UMTA (relative) criteria were used to assess the impacts from BART train operational noise. The APTA Criteria are based on existing conditions and therefore evaluate the impact of project implementation on the existing environment. The UMTA criteria evaluate the cumulative change in noise exposure based on the difference between the Alternative 1 projected for the year 2010, and the projected cumulative noise from the operation of BART trains in the Proposed Project or extension alternatives, and any other project-related changes.

Where both UMTA and APTA criteria would be satisfied for a finding of "no significant noise impact," mitigation would not be necessary. To determine impact, the methodology used was to first compare the projected passby noise with the APTA passby guidelines. If the APTA guidelines were not satisfied, significant impact was noted and noise mitigation was evaluated. If the APTA guidelines were not exceeded, then the UMTA criteria were applied to verify that no significant impact would occur. If the UMTA criteria were not satisfied, an impact was indicated and noise mitigation was evaluated.

The noise level projections and effectiveness of potential mitigations are sufficiently accurate for the purposes of an environmental analysis. However, final noise predictions and specific details of noise mitigation measures (e.g., exact height, location and extent of sound barrier walls) would be determined in the final engineering design phase of the project.

**Proposed Project.** Selected examples of noise levels projected for the Proposed Project are shown in Appendix Table E-1. In summary, the passby noise levels without mitigation for the Proposed Project would exceed the APTA criteria at numerous sensitive receptors, and the UMTA criteria at several receptors. The number of receptors affected by a significant noise impact without mitigation would be approximately 106. The following is a discussion of impacts at specific receptors along the Proposed Project alignment, running north to south.

The radius of the curve adjacent to the Fremont Villas condominiums is large enough so that there would be no "shrill squeaks" as expressed in a letter of concern from the Fremont Villas Homeowners' Association in response to the previous DEIR for the project. However, without noise mitigation the passby noise levels at the Fremont Villas (78-80 dBA on embankment, 83-85 dBA on aerial structure) would exceed the APTA criterion of 75dBA by 5 dBA adjacent to the embankment section and 10 dBA adjacent to the aerial structure. Furthermore, without mitigation the change in  $L_{dn}$  would be 7 dBA and 12 dBA respectively. Both APTA and UMTA criteria would be exceeded and the operational noise levels without mitigation would

result in a significant impact at Fremont Villas condominiums. The APTA criterion would be satisfied at both the Mission Wells and Sun Pointe residential complexes, but the peak-hour  $L_{eq}$  would increase by 6 dBA at the Sun Pointe development without noise mitigation. This would also constitute a significant impact.

Noise impacts on Fremont's Central Park are of serious concern to the City, as expressed in comments on the previous DEIR for the project. Several park areas with different uses would be affected by noise from BART operations above ground. In the northern portion of the park are several sports (soccer, softball) fields where the APTA noise limit criterion is 75 dBA; without mitigation, the APTA criterion would be exceeded by 12 dBA at the softball fields and 1 dBA at the soccer fields, indicating a significant impact at the softball fields. Whereas a 1dBA exceedance is not considered a significant impact.

The area in the northern part of Lake Elizabeth, used by boaters and for fishing is farther away from the UPRR and SPTCo railroad tracks than the eastern part of the lake, and can be classified as a "quiet outdoor recreation area." The APTA criterion would be 70 dBA for this use. The closest land in the park across Lake Elizabeth would be approximately 1,500 feet away from this alignment alternative. The area at the northern end of the park, west of the baseball fields and near the animal shelter, would be approximately 800 feet away from the Proposed Project alignment. The APTA passby criterion would be exceeded by 14 dBA at 300 feet from the alignment. Without noise mitigation, it would require a distance of 1,400 feet to satisfy 70 dBA, indicating a significant impact for most of Lake Elizabeth.

The area on the eastern edge of the park is affected by freight train activity and has a higher existing ambient noise level than the rest of the park; an APTA criterion of 75 dBA is appropriate for this area. That criterion would be exceeded by 12 dBA or more within 750 feet of the alignment in the eastern part of the park, indicating a significant noise impact without mitigation.

There has been an expressed concern over the effect of BART noise on wildlife that inhabits or is in migration through the park. While there are no definitive studies on the effects of noise on wildlife, available literature indicates that loud impulsive noise will scare animals and possibly disrupt their breeding. Loud steady or unvarying noise can also have an adverse effect on wildlife by masking their ability to communicate, which may interfere with breeding and survival. Areas closest to the alignment would be subject to the greatest noise, but the operation of BART does not produce impulsive noises, and passbys typically last no longer than 15 seconds. The impact of BART noise on wildlife if any, is minor and temporary in nature.



### Section 3.13 Noise and Vibration

Furthermore, no reported instances of detriment to wildlife along 75 miles of existing BART track would indicate that there is no significant noise impact to wildlife due to normal transit train operational noise.

The residences to the east of the UPRR on Vaca Drive and Valdez Drive would be exposed to noise levels exceeding the APTA criterion. The APTA criterion for the residences in this area is 75 dBA, because of the lower ambient noise level due to shielding of freight train and other noises by the existing sound barrier wall. That sound barrier wall would be somewhat effective in shielding noise from the aerial structure, but the impact analysis methodology does not include this factor. Without noise mitigation for the aerial structure, passby noise levels would exceed the criterion by 8 dBA at the homes closest to the Proposed Project alignment, and exceed by 5 dBA for the homes farther away. Inclusion of the effectiveness of the existing sound barrier wall could reduce this by as much as 5 dBA. Consequently, there would still be a significant impact without mitigation.

From Paseo Padre Parkway south, the alignment would be in the railroad right-of-way where ambient noise levels are significantly higher. Consequently, a higher APTA criterion is appropriate for this portion of the alignment. As indicated in Appendix Table E-1, there are numerous other receptors that would be affected by noise without mitigation.

The single-family residences on the west side of the alignment, between Washington Boulevard and Durham Road, would have passby noise levels that exceed the criterion by from 1 to 6 dBA depending on their proximity to the alignment and BART train speeds in the area. Crossover switches at that location would cause higher noise levels due to transit vehicle wheels passing over the switch gaps. The criterion would be exceeded by 6 dBA at several residences adjacent to the crossover switch, resulting in a significant impact.

Grimmer School playground and park is an active outdoor area for which the criterion is 75 dBA. The passby noise level would exceed this criterion by 8 dBA without noise mitigation, resulting in a significant impact. Passby noise levels at the school classrooms would be lower, because of the greater distance, and would satisfy the APTA criterion of 75 dBA for schools.

### Section 3.13 Noise and Vibration

Beyond Durham Road, there are numerous light industrial and office complexes (some quite close to the Proposed Project alignment) and an occasional single-family residence. Without noise mitigation there would be a significant noise impact at some of these receptors.

The transit car wash facility at the end of the Proposed Project alignment would be near Kato Road, and surrounded by light industrial land uses. To the south of the facility, residences in the City of Milpitas would be approximately 1,000 feet away from the proposed car wash facility. No blowers are to be used to dry cars. The maximum noise level has been measured at 65 dBA at 100 feet. The wash facility will be at least 200 feet and 100 feet away from offices and light industry buildings respectively. At these distances, no significant noise impact is indicated for the car wash location currently proposed for this alternative. Similarly, the emergency maintenance and inspection pit would generate only infrequent noise and would not result in any significant impact.

Ancillary facilities such as traction power substations also will be located along the alignment. Such substations will be located at each station and/or approximately 1.5 miles apart between stations. The criteria for evaluating the impacts of these facilities is similar to those used for wayside noise impacts, except that equipment generating continuous noise shall be limited to levels which are 5 dBA lower. All substations will be located above ground; transformers and cooling fans are the two main noise sources from substations. Based on measured noise levels for existing BART substations, residences at least 200 feet away from the substation equipment, regardless of the surrounding land use and ambient noise experience no significant impact. Residences closer than 200 feet have potential for impact, depending on the APTA area category. Along the railroad right-of-way, where ambient noise levels are higher, residences would need to be closer than 100 feet for impact to occur. Based on the current locations indicated for substations, no significant noise impact would occur. If, during preliminary engineering the substations are placed closer to sensitive receptors, the design of each facility should be evaluated to determine the need for noise-reduction features such as sound barrier walls, complete enclosures around noise sources, and sound attenuators on fans, blowers and cooling towers.

### Groundborne Noise and Vibration

Predicted groundborne noise and vibration levels for the BART Warm Springs Extension rail alignment alternatives take into account several factors and are based on methodology presented in the *Handbook of Urban Rail Noise and Vibration Control*<sup>1</sup>. Groundborne vibration from operation of the train is of such a low level that there is no possibility for structural damage to buildings near the alignment. The major potential for impact is from annoyance due to the perception of vibration in nearby buildings by the occupants. The criteria for evaluating the impact of groundborne vibration from rail transit systems is presented in Section 3.13.1. Groundborne noise in receptor buildings as a result of vibration has only been projected for receptors that would be adjacent to the subway alignment design option. The APTA criteria for groundborne noise are discussed in Section 3.13.1.

#### Notes on Transit System Vibration Characteristics

*Operations of rail transit systems result in "groundborne vibration." This vibration can be transmitted from the track structure to adjacent buildings via the intervening geologic strata. Vibration originates at the wheel or rail interface and is generated by the wheels rolling on the rails. The level of vibration at the source is influenced by the degree of roughness or smoothness of the wheels and rails, transit vehicle characteristics, train speed, and the type of track structure. The level of groundborne vibration reaching a receptor building is influenced by geologic factors, by proximity to the vibration source, and the characteristics of the building.*

*Inside nearby buildings, where the airborne component of noise from transit trains is sufficiently attenuated or nonexistent, such as is the case with subway operation, groundborne noise may be perceived as a low-pitched rumbling noise radiated inside the building structure by the groundborne-induced vibration of the building's walls, floors and ceiling.*

Vibration data obtained from measurements of actual vibration levels adjacent to other existing BART transit facilities have been used. The vibration levels projected for the alternatives studied take into consideration the local soil conditions indicated by the soil-boring data for the corridor as obtained in subsurface investigations.

Although sufficiently accurate for the purpose of environmental impact analysis, the projection of groundborne noise and vibration reported here are still approximations which require further refinement in the engineering phase of the project. Dynamic measurements of site specific soil and building characteristics should be performed to more accurately determine the expected levels of groundborne vibration.

<sup>1</sup> Wilson, Ihrig & Associates, 1982, op. cit.

**Proposed Project.** Appendix Table E-3 indicates the projected levels of groundborne vibration for selected receptors adjacent to the Proposed Project alignment. The groundborne vibration adjacent to most of the alignment would meet evaluation criteria and in most cases be imperceptible. However there are areas adjacent to the Proposed Project alignment that would have vibration levels that exceed the criteria. A total of ninety-nine (99) receptors are estimated to be affected by a significant vibration impact without mitigation.

The condominiums at Fremont Villas would be affected by significant vibration impact. Without mitigation, the vibration level adjacent to the embankment section of the Proposed Project is projected to exceed the criterion by 4 dB.

The Horner House, which would be located 220 feet from the alignment, would be far enough away such that vibration would be imperceptible and result in no significant impacts.

South of Washington Boulevard, approximately 38 residences would be 85 feet from the alignment, and vibration levels are projected to exceed the criterion by 3 dB. The crossovers at Blacow Road would result in excessive vibration at approximately eight nearby residences unless mitigation were implemented. (The switches produce higher levels of vibration than standard trackwork.) A significant impact is indicated for these two areas.

Beyond Grimmer School, train speed increases, resulting in higher vibration levels, which, for approximately 33 residences on the west side of the alignment, would exceed the criterion by as much as 7 dB, resulting in a significant impact. The other areas of vibration impact occur south of Mission Boulevard. There are office buildings close to the alignment and the projected vibration levels without mitigation exceed the criterion by 2 to 3 dB, indicating a significant impact.

### **Noise Mitigation**

Feasible noise mitigation measures for BART aerial structures consist of a short (approximately 3-foot high) sound barrier wall, with sound absorbing material on the inside faces. BART's current standard aerial structure sound barrier will be adequate. That design includes a completely sealed joint between wall and guideway and between adjoining wall segments. Figure 3.13-2 depicts existing BART aerial structures, both with and without sound barrier walls. The aerial sound barrier wall can be constructed on one or both sides of the guideway structure. Only a short wall is necessary, because the wall would be very close to the vehicle noise sources. Where additional noise reduction is necessary a closed deck between the two guideways is possible.



BART Aerial Structure Without Noise Barrier Wall - Richmond Line South of Marin Avenue in Albany



BART Aerial Structure With Noise Barrier - Richmond Line North of Gilman Street in Berkeley

**Figure 3.13-2**

**BART AERIAL STRUCTURES WITH AND WITHOUT NOISE BARRIERS**

SOURCE: Donaldson Associates, 1991

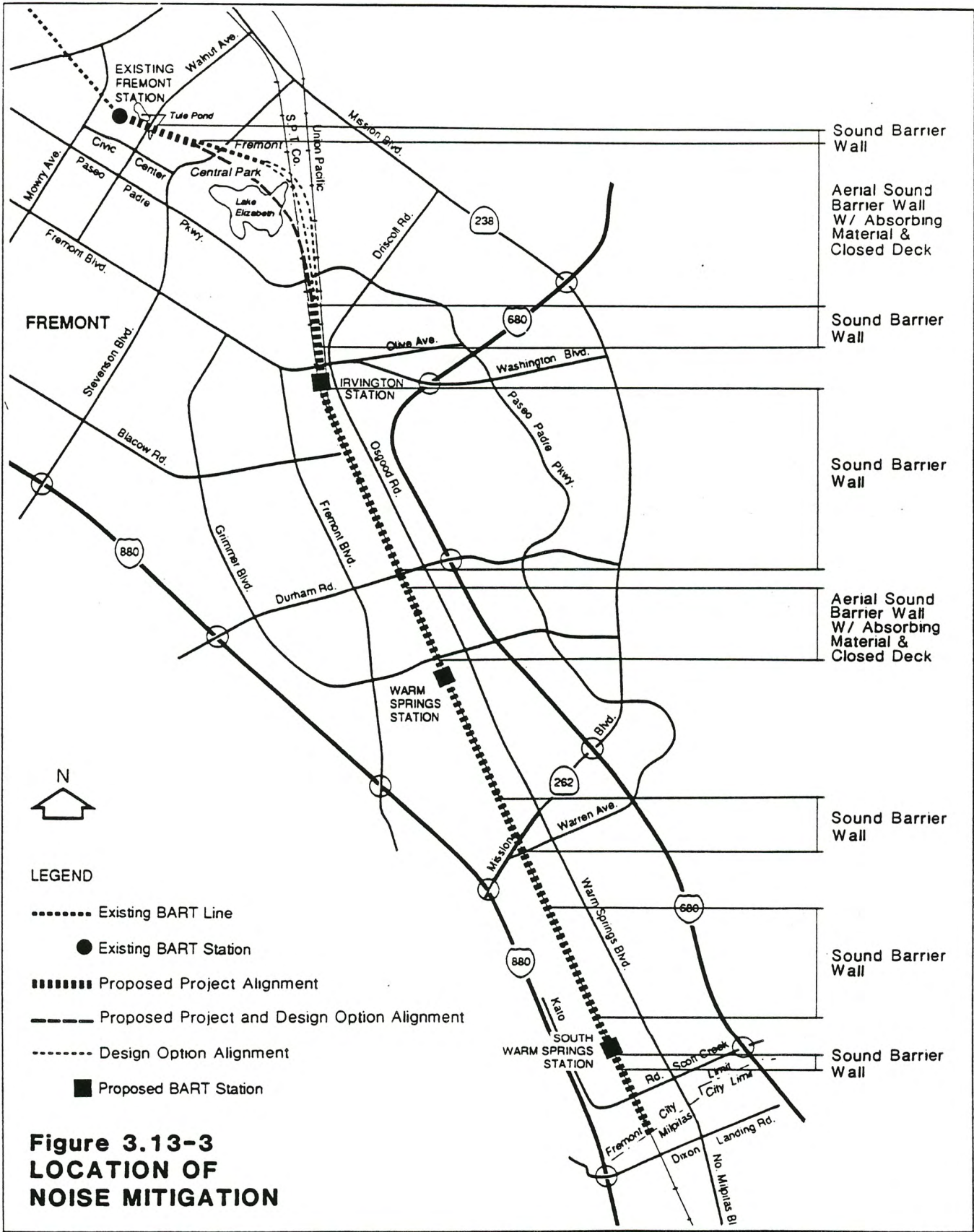
For at-grade track, a higher (approximately 6 to 7 feet) sound barrier wall or equivalent mitigation measure is necessary due to access requirements which place the wall farther from the track (assumed to be within 11 feet from the centerline of the near track) than it is on an aerial structure. In some circumstances it may be necessary to locate the at-grade sound barrier wall even farther away (e.g., at a property line), where a higher wall would be required (as much as 10 to 12 feet).

**Proposed Project.** Mitigations at sensitive receptors are discussed north to south, as in the discussion of projected impact. Locations of noise mitigation for the Proposed Project are shown in Figure 3.13-3. The total length of sound barrier wall necessary to eliminate significant impact is approximately 32,500 feet (counting both sides of at-grade and aerial combined). Implementation of noise mitigation measures would reduce the passby noise to levels that would not cause significant impact except to some receptors in Central Park, as noted below.

At the Fremont Villas condominiums, projected noise levels would satisfy the APTA criterion if a sound barrier wall on both sides of the aerial structure and a closed deck were implemented. The maximum change in noise exposure level would then be 5 dBA for the peak-hour  $L_{eq}$  at this receptor, satisfying the UMTA criteria. Although not necessary for residences in the Mission Wells complex, a sound barrier wall would be necessary on the east side of the aerial structure for the Sun Pointe residences, so as to reduce the increase in peak-hour  $L_{eq}$  to less than 6 dBA.

At the softball and soccer fields in Central Park, passby noise levels would satisfy the APTA criterion with the implementation of sound barrier walls on both sides of the structure and a closed deck. It has been assumed that two of the existing softball fields would either be eliminated or relocated for this alignment. The change in noise exposure levels (4 dBA or less) would satisfy the UMTA criterion for these receptors.

In the area of Lake Elizabeth, at distances greater than 300 feet from the alignment, the APTA criterion would be satisfied with the implementation of sound barrier walls on both sides of the aerial structure and a closed deck. In areas closer than 300 feet, there would be a residual significant impact. The area of Lake Elizabeth affected after mitigation would be about 10 acres. Another mitigation measure, which would lessen the area affected by noise impact, consists of moving the alignment to the north and east towards the soccer fields (as proposed in Design Options 2A and 3).



Source: Wilson Ihrig, 1991

At the eastern edge of the park and west of the alignment, where the APTA criterion is 75 dBA, a distance of 150 feet is necessary for no significant impact with implementation of sound barrier walls on both sides and a closed deck. Areas closer than 150 feet would have a residual significant noise impact. Measures involving movement of the alignment would also apply for this area of the park.

The parkland affected by noise levels above the criteria is approximately 33 acres, which includes the area between Lake Elizabeth and the softball fields that has a lower ambient level. The area of the park, out of 440 acres, with a residual significant impact would be approximately 7.5 percent.

Construction of sound barrier walls on both sides of the structure and a closed deck would eliminate any significant noise impact for the homes east of the UPRR on Vaca and Valdez Drives. With noise mitigation, there would be no change in noise exposure levels for these residences.

South of Paseo Padre Parkway, numerous receptors on the west side of the alignment would be affected by noise without mitigation. However, an approximately 7-foot-high sound barrier wall directly adjacent (11 feet or less) to the alignment at locations where impact would occur, could reduce noise levels below a level of significance.

An alternative to the sound barrier wall at crossover switch locations is installation of a special "switch frog" which eliminates the additional noise associated with the rail gap on standard switches. In some of the switch locations there may still be an impact requiring mitigation from the track portion of the switch.

### **Vibration Mitigation**

There are two feasible forms of vibration mitigation for at-grade track that would be appropriate for the Proposed Project alignments. The first is "resiliently supported ties"<sup>1</sup> which would provide a moderate amount of reduction in groundborne vibration. This measure can be used where receptors are not very close and train speeds are not at very high levels. However, use of resiliently supported ties raises the wayside noise levels, compared to ballasted track. This is due to the concrete trackbed used in the design, which is less effective in absorbing sound.

---

<sup>1</sup> Resiliently supported ties (e.g., Stedef, Nucor) provide vibration reduction by isolating the rail with concrete blocks resting in rubber boots.



Noise-reducing mitigation measures may be necessary in conjunction with the use of resiliently supported ties. Where more vibration reduction is necessary, a "floating slab trackbed"<sup>1</sup> system would be required.

**Proposed Project.** Locations of vibration mitigation for the Proposed Project are shown in Figure 3.13-4. The total length of vibration mitigation required for this alternative is 10,600 feet. The first area requiring mitigation would be adjacent to the condominiums at Fremont Villas. Resiliently supported ties would provide enough vibration reduction. The indicated maximum vibration level for this receptor is 1 dB over the criterion, even with mitigation, but is essentially in compliance and would be imperceptible. There would be no residual significant vibration impact at this level.

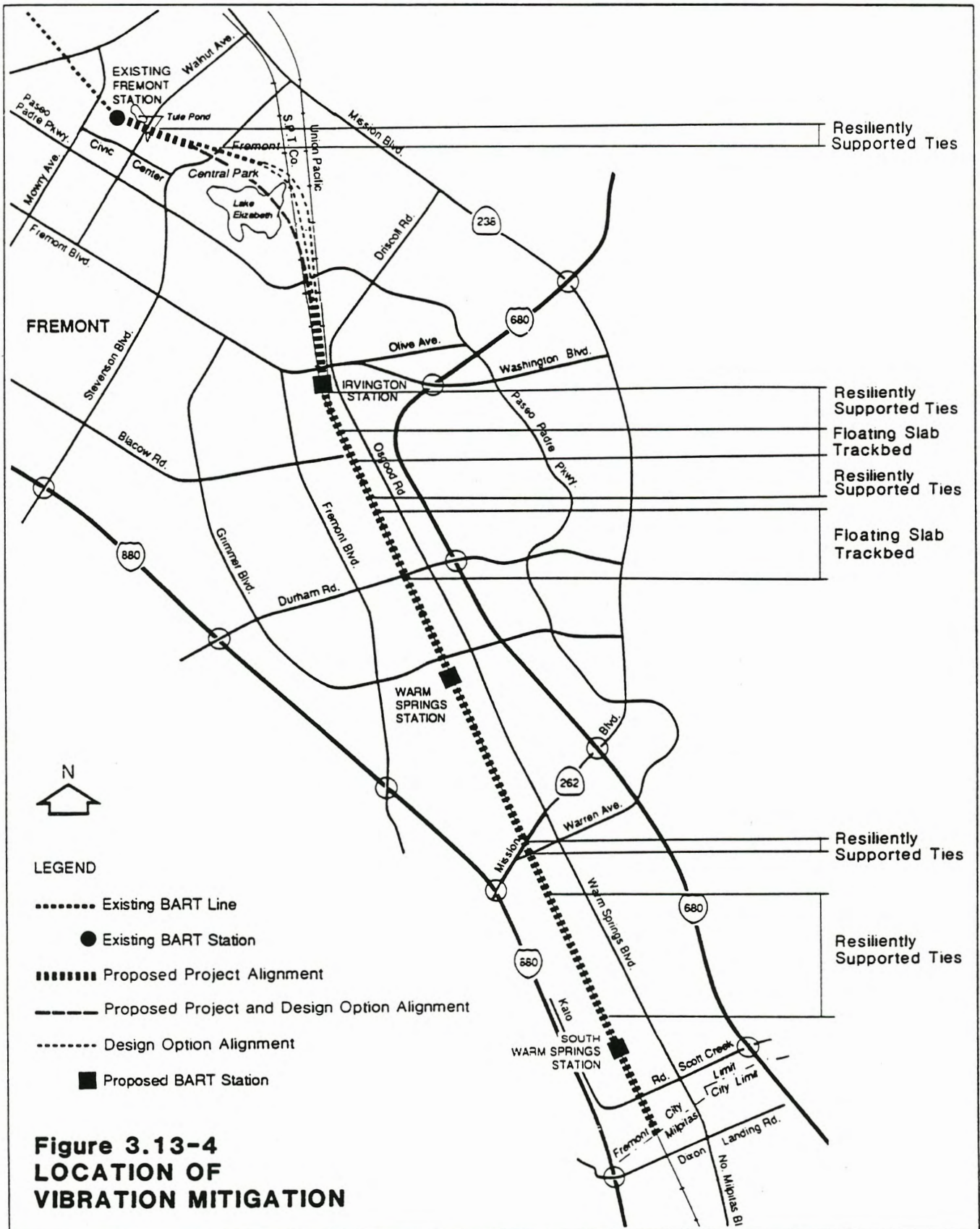
South of Washington Boulevard, where residences would be 80 feet from the alignment and vibration levels are projected to exceed the criterion by 3 dB, resiliently supported ties on both tracks would produce acceptable levels of vibration and result in no significant impact. As the use of resiliently supported ties raises wayside noise levels, this area would then exceed the noise level criteria, requiring an additional 2,000 feet of sound barrier wall on the west side as noise mitigation. This additional length of sound barrier wall has been included in the approximate suggested length of the at-grade sound barrier wall.

The crossovers at Blacow Road would result in excessive vibration at nearby residences unless mitigation were implemented. The switches produce higher levels of vibration than standard trackwork. A floating slab trackbed may be used to mitigate this impact, extending beyond both crossovers and under both tracks. Even with a floating slab there may be one or two residences with vibration levels above the criterion. Use of special switches would result in levels below the criteria if used in conjunction with resiliently supported ties.

An alternative to special switches would be to locate the switch to an area with no vibration sensitive receptors close by. The section of alignment adjacent to Grimmer School would be appropriate, because the school and residences are far enough away. However, airborne noise would exceed the passby criterion at the playground even with a sound barrier wall, if standard switches were used.

---

<sup>1</sup> Floating slab trackbed provides vibration reduction by isolating the rail with thick concrete slabs supported by resilient rubber pads.



Source: Wilson Ihrig, 1991

## Section 3.13 Noise and Vibration

Beyond Grimmer School where train speeds increase, the resulting groundborne vibration levels affecting residences on the west side of the alignment would exceed the criteria by as much as 7 dB. Resiliently supported ties would not provide adequate vibration reduction, and a floating slab trackbed may be necessary, resulting in a reduction of vibration impact below a level of significance. The floating slab would extend from Grimmer School to Durham Road.

South of Mission Boulevard, office buildings close to the alignment are projected to receive vibration levels which exceed the criterion by 2 to 3 dB. Resiliently supported ties in these areas would reduce the vibration impact below a level of significance.

### **Residual Noise and Vibration Impacts After Mitigation**

**Proposed Project.** Two significant impacts cannot be mitigated for this alignment.

There would be a residual noise impact on the far northeastern part of Lake Elizabeth and the northeastern part of Central Park for the Proposed Project. Approximately 7.5 percent of the park would be affected. This residual significant impact would be the same for all alternatives with the Proposed Project's aerial structure alignment through the park.

Residual vibration impacts after mitigation would occur at a few residences adjacent to the crossovers at Blacow Road unless special switches and resiliently supported ties are used.

### **Cumulative Impacts**

There are no reasonably foreseeable projects proposed to be built in the BART Warm Springs Extension corridor area that would result in significant cumulative impacts. However, as discussed above, the cumulative impact due to the increase in noise associated with greater motor vehicle traffic in the corridor area in conjunction with operational transit noise associated with the Warm Springs project has been evaluated using the UMTA criteria. These noise impact analyses have been discussed above for the Proposed Project and in the following sections for each alternative alignment.

### 3.13.3 IMPACTS OF DESIGN OPTIONS

#### Noise Impacts

**Design Option 1 (Subway).** This subway design option would eliminate the airborne component of noise impact for Central Park and the residences east of the UPRR, but would still have the potential of groundborne noise impact due to vibration transmitted through the intervening soil to adjacent nearby structures. (Vibration is radiated as noise inside buildings.) However, there are no sensitive receptors close enough to the subway portion of this option to be adversely affected by groundborne noise. Consequently, noise impact would not be significant for the subway portion of this option.

**Design Option 2A (Aerial).** Selected examples of noise levels projected for this aerial option are shown in Appendix Table E-2. Option 2A places the aerial structure through Central Park further north and east than the Proposed Project, with reduced design speeds (from 70 mph to 50 mph). Compared to the Proposed Project, Design Option 2A results in lower noise levels on Lake Elizabeth and reduces the area of the park affected by noise. However, a sizable portion of Lake Elizabeth would still be affected by noise. Without mitigation, noise criteria for the baseball and soccer fields would still be exceeded for this aerial option as would the criteria for the residences east of the UPRR, indicating a significant impact.

Although BART trains for this option would be closer to the residences east of the UPRR tracks and north of Paseo Padre, noise levels would be only slightly higher for this design option because trains would be operating at slower speeds. The existing sound barrier wall would not be quite as effective here as in the Proposed Project because the alignment would be closer to the residences, and is higher than the Proposed Project alignment. However, the analysis did not consider the existing sound barrier wall for noise shielding.

**Design Option 2S (Subway).** This subway design option, except for the location of the alignment, would be similar to Design Option 1 in terms of impacts, and would eliminate the airborne component of noise impact for Central Park and the residences east of the UPRR. As with Design Option 1, there are no sensitive receptors close enough to the subway portion of this option to be adversely affected by groundborne noise. Consequently, noise impact would not be significant for the subway portion of this design option.

**Design Option 3.** Selected examples of noise levels projected for this option are shown in Appendix Table E-2. Design Option 3 locates the aerial structure even farther north in the park than Design Option 2A, and just west of the UPRR tracks on the eastern side of the railroad right-of-way. There would still be a significant impact on Lake Elizabeth for this option, and noise levels at the soccer fields would be the same as for Option 2A.

Homes on the east side of the UPRR would experience even higher levels (by as much as 5 dBA) with this option compared to the Proposed Project and Design Option 2A. The APTA criterion would be exceeded by as much as 7 dBA without noise mitigation for the closest residences. The existing sound barrier wall, though not a factor in the impact evaluation analysis, would provide little or no shielding for transit train noise.

#### **Vibration Impacts**

**Design Option 1 (Subway).** The vibration levels at receptors adjacent to the alignment for the subway option in Central Park are the same as for the Proposed Project, except at the Fremont Villas. There would be more ballast-and-tie track in this area, which results in higher vibration levels compared to aerial structure, and four more residences would be affected.

South of Paseo Padre where the Proposed Project alignment goes below grade, the covered subway tunnel would produce only a minor reduction in groundborne vibration compared to the Proposed Project, the vibration impact would be similar. At affected receptors, groundborne noise impact for the subway option is similar to or less than the vibration impact. Consequently, the same vibration mitigation measures required for the Proposed Project also are required for Design Option 1, except for the additional length of resiliently supported ties adjacent to Fremont Villas.

**Design Option 2A (Aerial).** The vibration impact of this design option is the same as for the aerial alignment of the Proposed Project.

**Design Option 2S (Subway).** The vibration impact of this design option is the same as for Design Option 1 with the Proposed Project.

**Design Option 3 (Aerial).** The aerial alignment for this design option would be closer to the residences east of the UPRR, but far enough away so as to cause no significant vibration impact for these receptors. Therefore the vibration impacts are the same as the Proposed Project.

### **Noise Mitigation**

**Design Option 1 (Subway).** The sound barrier wall on the aerial structure through Central Park for the aerial design of this option would not be necessary. Otherwise, the mitigation requirements would be the same as for the Proposed Project alignment. If the indicated noise mitigation measures are implemented, impacts would be reduced to a level less than significant.

**Design Option 2A (Aerial).** Noise mitigation requirements for this option are similar to those for the Proposed Project. More aerial structure sound barrier walls would be required due to the increased length of the alignment.

With sound barrier walls on both sides of the aerial structure and a closed deck, the noise criterion applicable to Lake Elizabeth would be satisfied beyond 200 feet, because of the reduced design speed alone. Movement of the alignment north would leave only a very small portion (less than 1/2 acre) of Lake Elizabeth affected. In large part due to the lower speed, which results in a passby level of 75 dBA at less than 60 feet from the aerial structure, the total area of the park with a residual significant impact is approximately 3 acres or 0.7 percent for this option. Noise levels for this option would be slightly higher (2 dBA) at the soccer fields, but would still satisfy the APTA criterion with mitigation described in the Proposed Project discussion.

Homes on the east side of the UPRR would experience slightly higher levels (2 to 3 dBA) with this option, but the APTA criterion would be satisfied with sound barrier walls on both sides of the aerial structure and a closed deck. There would also be a 1 dBA change in the  $L_{dn}$  for residences in this area; this would not be a significant impact.

**Design Option 2S (Subway).** The noise mitigation requirements for this design option with the Proposed Project are the same as those for Design Option 1.

**Design Option 3 (Aerial).** Noise mitigation requirements for this option are similar to those for the Proposed Project. More aerial structure sound barrier walls would be required, because of the increased length of the aerial alignment.

With sound barrier walls on both sides of the aerial structure and a closed deck, there would be no significant impact on Lake Elizabeth for this option. However, the total area of park affected by noise would be the same as in Design Option 2A. Noise levels at the soccer fields would be slightly higher than for Design Option 2A, but still within the APTA criterion.

Homes on the east side of the UPRR would experience substantially higher levels than for the Proposed Project. However, the APTA criterion would be satisfied with sound barrier walls on both sides of the aerial structure, and a closed deck. With mitigations, there would be a 1 dBA increase in the  $L_{dn}$  for residences in this area; this would not be a significant impact.

#### **Residual Noise Impacts**

**Design Option 1.** There would be no residual noise impacts for this design option. The residual vibration impact would be the same as for the Proposed Project.

**Design Option 2A (Aerial).** There would be essentially one significant impact that cannot be mitigated for this design option. There would be a residual noise impact on the far northeastern part of Central Park and a very small portion of Lake Elizabeth (½ acre). Approximately 0.7 percent of the park would be affected. The residual vibration impact would be the same as for the Proposed Project.

**Design Option 2S (Subway).** There would be no residual noise impacts for this design option. The residual vibration impact would be the same as for the Proposed Project.

**Design Option 3.** There would be only one significant impact that cannot be mitigated for this design option. There would be a residual noise impact on the far northeastern part of Central Park. Approximately 0.7 percent of the park would be affected. The residual vibration impact would be the same as for the Proposed Project.

#### **3.13.4 IMPACTS OF ALTERNATIVE 1: No Project and No Transportation Improvements (Status Quo)**

##### **Noise Impacts**

This alternative reflects existing conditions and therefore would create no change to the ambient noise levels.

##### **Vibration Impacts**

This alternative would result in no increase in the levels of groundborne vibration.

**3.13.5 IMPACTS OF ALTERNATIVE 2: No Project, Programmed Transportation Improvements**

**Noise Impacts**

Highway improvements in the area would not affect the immediate corridor study area. The environmental impact of highway improvements would be assessed by Caltrans following the Federal Highway Administration noise abatement criteria. Where existing noise conditions exceed criteria, it is Caltrans policy to provide noise mitigation. In almost all instances, the resulting noise levels after implementation of sound barrier walls are less than the existing noise levels especially close to the sound barrier wall. These highway projects are not close enough to the rail alignment to have more than a minor effect on the noise levels in the immediate corridor.

**Vibration Impacts**

This alternative should result in no perceptible increase in the levels of groundborne vibration.

**3.13.6 IMPACTS OF ALTERNATIVE 3: Transportation Systems Management (TSM)**

**Noise Impacts**

In addition to the highway improvements in Alternative 2, this alternative includes widening I-880 and I-680 and the incorporation of a High Occupancy Vehicle (HOV) lane on I-880. The environmental impact of these highway improvements would be assessed by Caltrans following the Federal Highway Administration noise abatement criteria. Where existing noise conditions exceed criteria, it is Caltrans policy to provide noise mitigation. In almost all instances, the resulting noise levels after implementation of sound barrier walls are less than the existing noise levels especially for receptors close to the sound barrier. The I-680 improvement should result in a minor decrease in noise in the study area if sound barrier walls are constructed.

**Vibration Impacts**

This alternative should result in no perceptible increase in the levels of groundborne vibration.



**3.13.7 IMPACTS OF ALTERNATIVE 4: A 5.4-Mile BART Extension with Two Stations, and Relocated Railroad**

This alternative requires relocation of both railroad tracks. The SPTCo tracks would be relocated to the east from north of Paseo Padre Parkway to just north of Blacow Road. The amount of displacement would vary depending on location along the alignment with as much as 350 feet of movement occurring between Paseo Padre Parkway and Washington Boulevard. The UPRR tracks would be relocated to the west, but by a smaller amount (approximately 50 feet). Both railroad alignments would be depressed below grade to cross under Washington Boulevard. From Blacow Road to Grimmer Road, the BART tracks would be located on the eastern edge of the railroad right-of-way, with the UPRR tracks in this area displaced to the west by approximately 20 feet.

**Noise Impacts**

Although the noise levels on the east side of the railroad right-of-way would increase due to freight train traffic in conjunction with relocation of the SPTCo tracks, depression of the freight tracks would actually lower noise levels overall. A net decrease in ambient noise (from 2 to 4 dBA) is projected for freight-generated noise. A similar decrease on the west side of the alignment is expected due to moving the tracks away from the receptors and depressing the tracks. The relocation of the UPRR and SPTCo tracks would result in an improved noise environment in the area north of Paseo Padre Parkway to north of Washington Boulevard.

Relocation of the UPRR tracks between Washington Boulevard and Grimmer Road and the operation of BART in this area would result in a minor increase in the noise levels on the west side of the Proposed Project alignment. The increase in noise due to trains on the UPRR alone would be less than 1 dBA. Therefore, displacement of the UPRR tracks by 20 feet would cause no significant noise impact, by itself, but has the potential for causing cumulative impact.

Selected examples of noise levels projected for this alternative are shown in Appendix Table E-4. Approximately 42 receptors would be affected by a significant noise impact without mitigation for this alternative.

The car wash facility and emergency maintenance and inspection pit for this alternative are surrounded by industrial buildings. The wash facility and pit noise levels are not high enough to cause a significant noise impact.

#### **Vibration Impacts**

The vibration impacts of this alternative are similar to those for the Proposed Project, except that the alignment is shorter and has fewer impacts. Relocation of the railroads would not result in higher levels of vibration, because the relocation would not move either freight alignment closer to the receptors than the existing alignments.

#### **Noise Mitigation**

With mitigations similar to the Proposed Project, the relative change in noise exposure levels satisfies the UMTA criteria. The passby noise levels satisfy the APTA criteria with mitigation. The total length of sound barrier walls necessary to eliminate this impact would be approximately 22,600 feet.

#### **Vibration Mitigation**

Vibration mitigation is the same as for the Proposed Project along their common alignment, but the total length of vibration mitigation is 10,600 feet.

#### **Residual Impacts After Mitigation**

The residual noise and vibration impacts for this alternative are the same as for the Proposed Project.

#### **3.13.8 IMPACTS OF ALTERNATIVE 5: A 5.4-Mile BART Extension with Two Stations**

Alternative 5 is a shortened version of the Proposed Project which ends at the Warm Springs Station tailtrack. Therefore, the projected wayside noise and groundborne vibration levels for the Proposed Project are applicable. The number of affected receptors would be fewer and the amount of noise and vibration mitigation would be less.

### **Noise Impacts**

The number of receptors affected by a significant noise impact without mitigation would be approximately 98 for this alternative. The noise impact for the car wash facility and emergency maintenance and inspection pit for this alternative is the same as for Alternative 4. There would be no significant noise impact for the car wash facility, or for the emergency maintenance and inspection pit in the tailtrack area.

### **Noise Mitigation**

With mitigation, the relative change in noise exposure levels satisfies the UMTA criteria. The passby noise levels satisfy the APTA criteria with mitigation except for the park as discussed in the Proposed Project. The total length of sound barrier walls necessary to eliminate this impact would be approximately 27,300 feet.

### **Vibration Mitigation**

The vibration mitigation is the same as for the Proposed Project where the two alignments are the same. Being shorter, the total length of vibration mitigation is 7,700 feet.

### **Residual Impacts after Mitigation**

The residual noise and vibration impacts for this alternative are the same as for the Proposed Project.

### **3.13.9 IMPACTS OF ALTERNATIVE 6: A 7.8-Mile BART Extension with Two Stations (No Irvington Station)**

Alternative 6 is the same length as the Proposed Project, but does not have an Irvington station. Without an Irvington station, there is potential for additional noise and vibration impacts in this area due to higher train speeds. A design option at Washington Boulevard would allow an above-grade (on embankment) crossing of the roadway.

### **Noise Impacts**

The noise impacts of this alternative would be generally the same as in the Proposed Project. With the Washington Boulevard design option, more residences would be affected by a

significant noise impact in the Washington Boulevard area. Approximately 106 receptors would be affected by a significant noise impact without mitigation. The Washington Boulevard Design Option would add an additional 42 receptors affected by a significant noise impact without mitigation. The noise impacts for the car wash facility and emergency maintenance and inspection pit for this alternative is the same as for the Proposed Project. There would be no significant noise impact for the car wash facility, or for the emergency maintenance and inspection pit.

#### **Vibration Impacts**

Compared with the Proposed Project, there would be more residences affected by groundborne vibration because of the higher speeds without the Irvington station. Additional resiliently supported ties would be necessary to reduce vibration impact below a level of significance in this area.

#### **Noise Mitigation**

With the Washington Boulevard design option, sound barrier walls on both sides of the retained segment of track can reduce noise to levels which satisfy the APTA criteria. There would be no change in noise exposure levels and therefore no significant impact. With mitigation, the relative change in noise exposure levels satisfies the UMTA criteria. The passby noise levels satisfy the APTA criteria with mitigation. The total length of sound barrier walls necessary to reduce this impact below a level of significance would be approximately 32,500 feet.

#### **Vibration Mitigation**

The vibration mitigation is the same as for the Proposed Project where the two alignments are the same. The total length of vibration mitigation is 10,600 feet.

#### **Residual Impacts after Mitigation**

The residual noise and vibration impacts for this alternative are the same as for the Proposed Project.

**3.13.10 IMPACTS OF ALTERNATIVE 7: A 7.8-Mile BART Extension with Two Stations (No Irvington Station)**

In Alternative 7, the alignment would cross over to the east side of the UPRR tracks just south of Washington Boulevard. However, the alignment would be on an aerial structure which results in higher noise levels.

**Noise Impacts**

Selected examples of noise levels projected for this alternative are shown in Appendix Table E-5. Approximately 145 receptors would be affected by a significant noise impact without mitigation for this alternative. The noise impact for the car wash facility and emergency maintenance and inspection pit for this alternative is the same as for the Proposed Project. There would be no significant noise impact for the car wash facility, or for the emergency maintenance and inspection pit.

**Vibration Impacts**

Location of the alignment on an aerial structure on the east side of the railroad alignment would result in lower levels of groundborne vibration for residences on the west side of the alignment. No mitigation would be required in the aerial portion of this alternative between Washington Boulevard and Durham. There are also no crossover switches at Blacow Road as in the Proposed Project.

**Noise Mitigation**

With mitigation, the relative change in noise exposure levels satisfies the UMTA criteria. The passby noise levels satisfy the APTA criteria with mitigation except for the park as discussed in the Proposed Project. The total length of sound barrier walls necessary to reduce this impact below a level of significance would be approximately 40,300 feet.

**Vibration Mitigation**

The vibration mitigation is the same as for the Proposed Project where the two alignments are identical. The total length of vibration mitigation is 4,300 feet. The resiliently supported ties and floating slab for the at-grade segment between Washington Boulevard and Durham Road would not be required for this alternative.

### **Residual Impacts after Mitigation**

The residual noise impacts for this alternative are the same as for the Proposed Project. The residual vibration impacts are the same as the Proposed Project, except there would be none where this alternative eliminates the crossover switch at Blacow Road.

#### **3.13.11 IMPACTS OF ALTERNATIVE 8: A 7.8-Mile BART Extension Along Osgood Road and Warm Springs Boulevard, with Two Stations (No Irvington Station)**

This alternative is considerably different than the Proposed Project. Instead of an alignment in the railroad right-of-way after Washington Boulevard, the alignment would be on aerial structure in the middle of Osgood Road and Warm Springs Boulevard. In the northern part of this alternative the land use is commercial and light industry with occasional offices, whereas in the southern portion there are numerous residences on the east side of Warm Springs Boulevard. Both of these areas would be affected by noise impact.

#### **Noise Impacts**

Selected examples of noise levels projected for this alternative are shown in Appendix Table E-6. The office buildings along Osgood Road are close to the road as are the residences on Warm Springs Boulevard. Without mitigation, approximately 537 receptors would have noise levels exceeding the APTA criteria. The total length of sound barrier walls necessary to reduce this impact below a level of significance would be approximately 60,300 feet.

The car wash facility proposed for this alternative just south of Kato Road, where there is an industrial/office building within 80 feet, may have a significant impact if blowers, which are not part of the Proposed Project, were used. Noise aspects of the carwash facility would be investigated in preliminary engineering design. The emergency maintenance and inspection pit would generate only infrequent noise and would not result in any significant impact.

#### **Vibration Impacts**

Selected examples of vibration levels projected for this alternative are shown in Appendix Table E-7. Two single family residences would be within 40 feet of the alignment, and these would be exposed to vibration over the criterion level. There is currently no available mitigation

to reduce aerial structure vibration. Consequently, there would remain a significant vibration impact at these receptors, unless future dynamic soil testing conducted in the preliminary engineering phase indicated lower vibration levels. A similar situation would occur at residences along Warm Springs Boulevard, where vibration levels may exceed criterion by 3 dB and a residual impact would be indicated.

### **Noise Mitigation**

A major portion of the alignment would need a sound barrier wall on one side and in some areas on both sides of the aerial structure. Some areas would require a closed deck to reduce noise levels even further. Noise levels within 1 dBA of the APTA criterion are considered in compliance, and therefore no significant impact would occur.

With the mitigation indicated, there would be residual impact at the single family residence on Osgood Road and adjacent to the crossover north of Durham Road, the Warm Springs Grammar School and the single-family residences on the east side of Warm Springs Boulevard between Lippert Avenue and Maten Way. If a special switch frog were used at the crossover there would be no residual impact at that location. There would be a residual impact at the school and the single-family residences unless a reduction in operating speed were implemented in these areas.

### **Vibration Mitigation**

As indicated, there is no currently available vibration mitigation for the aerial structure. Otherwise, mitigation measures are the same as the Proposed Project. Approximately 400 feet of mitigation would be needed.

### **Residual Impacts after Mitigation**

The residual noise impacts for this alternative are the same as for the Proposed Project, with the addition of residual impact at several single family residences and a school on Osgood Road and Warm Springs Boulevard. There would be residual vibration impacts at several single-family residences unless subsequent testing indicated lower vibration levels.

**3.13.12 IMPACTS OF ALTERNATIVE 9: A 5.4-Mile BART Extension with One Station (Warm Springs)**

Alternative 9 is a shortened version of Alternative 6; the projected wayside noise levels for Alternative 6 from the Fremont BART Station to the proposed Warm Springs Station and tailtrack are applicable.

**Noise Impacts**

Approximately 90 receptors would be affected by a significant noise impact without mitigation for this alternative. The Washington Boulevard Design Option would add an additional 42 receptors affected by a significant noise impact without mitigation. The noise impact for the car wash facility and emergency maintenance and inspection pit for this alternative is the same as for Alternative 4. There would be no significant noise impact for the car wash facility, or the emergency maintenance and inspection pit in the tailtrack area.

**Vibration Impacts**

Approximately 87 receptors would be affected by a significant vibration impact without mitigation.

**Noise Mitigation**

The total length of sound barrier walls necessary to minimize noise impact would be approximately 27,300 feet for this alternative assuming an aerial structure through Central Park.

**Vibration Mitigation**

The total length of vibration mitigation necessary to reduce vibration impact below a level of significance would be approximately 7,700 feet assuming an aerial structure through Central Park.

**Residual Impacts After Mitigation**

The residual noise and vibration impacts for this alternative are the same as for the Proposed Project.



**3.13.13 IMPACTS OF ALTERNATIVE 10: A 7.8-Mile BART Extension with One Station (South Warm Springs)**

Alternative 10 is the same as the Proposed Project, but without the Irvington Station and Warm Springs Station. Without these stations, there is potential for additional noise and vibration impacts due to higher train speeds.

**Noise Impacts**

Between Washington Boulevard and Grimmer Road, the noise impact for Alternative 10 is the same as for Alternative 6. Just south of Grimmer Road an additional single family residence would be affected by the higher noise levels from the aerial structure. Otherwise, the impacts are the same as for the Proposed Project. Approximately 107 receptors would be affected by a significant noise impact without mitigation for this alternative. The Washington Boulevard Design Option would add an additional 42 receptors affected by a significant noise impact. The noise impact for the car wash facility and emergency maintenance and inspection pit for this alternative is the same as for the Proposed Project. These would be no significant noise impact for the car wash facility or for the emergency maintenance and inspection pit.

**Vibration Impacts**

Approximately 103 receptors would be affected by a significant vibration impact without mitigation.

**Noise Mitigation**

The total length of sound barrier walls necessary to minimize noise impact would be approximately 32,900 feet for this alternative.

**Vibration Mitigation**

The total length of vibration mitigation necessary to reduce vibration impact below a level of significance would be approximately 10,600 feet.

**Residual Impacts after Mitigation**

The residual noise and vibration impacts for this alternative are the same as for the Proposed Project.

**3.13.14 IMPACTS OF ALTERNATIVE 11: A 7.8-Mile BART Extension with Two Stations (No Warm Springs Station)**

Alternative 11 is the same as the Proposed Project, but with no Warm Springs Station. Consequently, the alignment and operational characteristics of Alternative 11 are the same as Alternative 10 in the vicinity of Grimmer Road. Without the station, operational speeds would be somewhat higher through this segment of the alignment, resulting in slightly higher noise levels and the potential for additional noise and vibration impacts in the area.

**Noise Impacts**

In the area just north and south of Grimmer Road, the noise impacts for Alternative 11 are the same as those for Alternative 10. Otherwise, the noise impacts for Alternative 11 are the same as those for the Proposed Project. As with Alternative 10, the increased noise levels without the Warm Springs Station affects an additional single family residence just south of Grimmer Road. Approximately 107 receptors would be affected by a significant noise impact without mitigation for this alternative. The noise impact for the car wash facility and emergency maintenance and inspection pit for this alternative is the same as for the Proposed Project. There would be no significant noise impact for the car wash facility, or for the emergency maintenance and inspection pit.

**Vibration Impacts**

Approximately 99 receptors would be affected by a significant vibration impact without mitigation.

**Noise Mitigation**

The total length of sound barrier walls necessary to minimize noise impacts would be similar to that of the Proposed Project with an additional 1,000 feet of aerial structure sound barrier wall just south of Grimmer Road, for a total of approximately 33,500 feet for Alternative 11.

**Vibration Mitigation**

The total length of vibration mitigation necessary to reduce vibration impact below a level of significance would be the same as the Proposed Project at approximately 10,600 feet.

**Residual Impacts after Mitigation**

The residual noise and vibration impacts for this alternative are the same as for the Proposed Project.

**3.13.15 SUMMARY OF OPERATIONAL IMPACTS**

**Noise Impacts**

Table 3.13-11 indicates the number of affected receptors without mitigation and the amount of mitigation necessary to reduce noise impact. Alternative 8 would result in the most noise impact based on number of receptors affected and would require the greatest extent of noise mitigation. Central Park Design Options 1 and 2S (subway options), when applied to the Proposed Project or Alternatives 4 through 11 (except for Alternative 8), would result in the least noise impact. Design Options 2A and 3 would result in magnitude of noise impact similar to the Proposed Project.

**Vibration Impacts**

Table 3.13-12 indicates the number of affected receptors without mitigation and the amount of mitigation necessary to reduce vibration impact. Alternative 8 would result in the least vibration impact based on the number of receptors affected and would require the least extent of vibration mitigation. Central Park Design Options 1 and 2S would result in a slightly greater impact than would Design Options 2A or 3. For alignments that follow the Proposed Project

alignment, primarily along the railroad right-of-way, vibration impacts are essentially the same. The amount of vibration mitigation for these alternatives varies with the length of the alignment.

### **3.13.16 NOISE AND VIBRATION IMPACT DURING CONSTRUCTION**

Activities related to construction of the Proposed Project and Alternatives 4 through 11 will result in short term noise and vibration impacts. Appropriate noise and vibration control measures taken during construction can minimize these impacts. This is particularly necessary where sections of the alignment are located close to sensitive receptors.

One of the most effective methods of assuring controlled noise and minimum noise impact is the inclusion of noise limit specifications in the construction contract documents. Recent construction projects in Atlanta (MARTA), New York City Transit Authority (NYCTA), and Washington Metropolitan Area Transit Authority (WMATA) systems have included noise restrictions in the contract specifications.

Criteria for construction noise and vibration control to be included in construction contract documents would be developed in the preliminary engineering phase. In addition to specifying actual noise and vibration limits, other mitigation measures could be:

- temporary noise barriers
- limitation on hours of activity
- limiting removal of material from U-wall and cut-and-cover operation to specific hours
- where possible, providing specific truck routes to each construction site to avoid residential streets or roads that pass by Central Park
- providing a careful maintenance and lubrication program for heavy equipment
- erection of noise barriers where specification noise limits can not be met with available construction equipment

**Table 3.13.11  
Summary of Anticipated Noise Impacts from BART Operations  
Proposed Project and Alternatives**

| Alternative           | Approximate Number of Sensitive<br>Receptors with Noise Above<br>Criterion Without Mitigation | -- Approximate Length of Necessary Mitigation (ft) -- |                                        |                |
|-----------------------|-----------------------------------------------------------------------------------------------|-------------------------------------------------------|----------------------------------------|----------------|
|                       |                                                                                               | At-Grade Sound<br>Barrier Wall                        | Aerial Structure Sound<br>Barrier Wall | Closed<br>Deck |
| Proposed Project      | 106                                                                                           | 15,600                                                | 16,900                                 | 8,100          |
| w/Design Option 1/2S  | 81                                                                                            | 13,300                                                | 700                                    | 0              |
| w/Design Option 2A    | 115                                                                                           | 15,600                                                | 17,500                                 | 8,400          |
| w/Design Option 3     | 145                                                                                           | 13,300                                                | 21,100                                 | 10,200         |
| Alternatives 1, 2 & 3 | N/A                                                                                           | N/A                                                   | N/A                                    | N/A            |
| Alternative 4         | 42                                                                                            | 5,300                                                 | 17,300                                 | 8,300          |
| w/Design Option 1/2S  | 18                                                                                            | 5,300                                                 | 700                                    | 0              |
| w/Design Option 2A    | 42                                                                                            | 5,300                                                 | 17,900                                 | 8,600          |
| w/Design Option 3     | 72                                                                                            | 5,300                                                 | 18,700                                 | 9,000          |
| Alternative 5         | 98                                                                                            | 10,400                                                | 16,900                                 | 8,100          |
| w/Design Option 1/2S  | 65                                                                                            | 8,100                                                 | 700                                    | 0              |
| w/Design Option 2A    | 98                                                                                            | 10,400                                                | 17,500                                 | 8,400          |
| w/Design Option 3     | 128                                                                                           | 8,100                                                 | 21,100                                 | 10,200         |
| Alternative 6         | 106                                                                                           | 15,600                                                | 16,900                                 | 8,100          |
| w/Design Option 1/2S  | 77                                                                                            | 13,300                                                | 700                                    | 0              |
| w/Design Option 2A    | 111                                                                                           | 15,600                                                | 17,500                                 | 8,400          |
| w/Design Option 3     | 141                                                                                           | 13,300                                                | 21,100                                 | 10,200         |
| Alternative 7         | 145                                                                                           | 11,100                                                | 29,200                                 | 8,100          |
| w/Design Option 1/2S  | 116                                                                                           | 8,800                                                 | 13,000                                 | 0              |
| w/Design Option 2A    | 150                                                                                           | 11,100                                                | 13,000                                 | 8,400          |
| w/Design Option 3     | 180                                                                                           | 8,800                                                 | 33,400                                 | 10,200         |
| Alternative 8         | 537                                                                                           | 400                                                   | 59,900                                 | 10,600         |
| w/Design Option 1/2S  | 537                                                                                           | 400                                                   | 47,100                                 | 14,200         |
| w/Design Option 2A    | 537                                                                                           | 400                                                   | 60,500                                 | 20,900         |
| w/Design Option 3     | 567                                                                                           | 400                                                   | 61,300                                 | 21,300         |
| Alternative 9         | 90                                                                                            | 10,400                                                | 16,900                                 | 8,100          |
| w/Design Option 1/2S  | 64                                                                                            | 8,100                                                 | 700                                    | 0              |
| w/Design Option 2A    | 90                                                                                            | 10,400                                                | 17,500                                 | 8,400          |
| w/Design Option 3     | 120                                                                                           | 8,100                                                 | 21,100                                 | 10,200         |
| Alternative 10        | 107                                                                                           | 15,000                                                | 17,900                                 | 8,100          |
| w/Design Option 1/2S  | 78                                                                                            | 12,700                                                | 1,700                                  | 0              |
| w/Design Option 2A    | 112                                                                                           | 15,000                                                | 18,500                                 | 8,400          |
| w/Design Option 3     | 142                                                                                           | 12,700                                                | 21,100                                 | 10,200         |
| Alternative 11        | 107                                                                                           | 15,600                                                | 17,900                                 | 8,100          |
| w/Design Option 1/2S  | 82                                                                                            | 13,300                                                | 1,700                                  | 0              |
| w/Design Option 2A    | 116                                                                                           | 15,600                                                | 18,500                                 | 8,400          |
| w/Design Option 3     | 146                                                                                           | 13,300                                                | 22,100                                 | 10,200         |

Source: Wilson, Ihrig & Associates, Inc., 1991.

**Table 3.13.12  
Summary of Anticipated Vibration Impacts from BART Operations  
Proposed Project and Alternatives**

| Alternative           | Approximate Number of Sensitive<br>Receptors with Noise Above<br>Criterion Without Mitigation | Approximate Length of Necessary Mitigation (ft) --<br>Resiliently<br>Supported Ties | Approximate Length of Necessary Mitigation (ft) --<br>Floating<br>Slab |
|-----------------------|-----------------------------------------------------------------------------------------------|-------------------------------------------------------------------------------------|------------------------------------------------------------------------|
| Proposed Project      | 99                                                                                            | 7,200                                                                               | 3,400                                                                  |
| w/Design Option 1/2S  | 103                                                                                           | 7,800                                                                               | 3,400                                                                  |
| w/Design Option 2A    | 99                                                                                            | 7,200                                                                               | 3,400                                                                  |
| w/Design Option 3     | 99                                                                                            | 7,200                                                                               | 3,400                                                                  |
| Alternatives 1, 2 & 3 | N/A                                                                                           | N/A                                                                                 | N/A                                                                    |
| Alternative 4         | 99                                                                                            | 7,200                                                                               | 3,400                                                                  |
| w/Design Option 1/2S  | 103                                                                                           | 7,800                                                                               | 3,400                                                                  |
| w/Design Option 2A    | 99                                                                                            | 7,200                                                                               | 3,400                                                                  |
| w/Design Option 3     | 99                                                                                            | 7,200                                                                               | 3,400                                                                  |
| Alternative 5         | 91                                                                                            | 4,300                                                                               | 3,400                                                                  |
| w/Design Option 1/2S  | 94                                                                                            | 4,900                                                                               | 3,400                                                                  |
| w/Design Option 2A    | 91                                                                                            | 4,300                                                                               | 3,400                                                                  |
| w/Design Option 3     | 91                                                                                            | 4,300                                                                               | 3,400                                                                  |
| Alternative 6         | 103                                                                                           | 7,200                                                                               | 3,400                                                                  |
| w/Design Option 1/2S  | 106                                                                                           | 7,800                                                                               | 3,400                                                                  |
| w/Design Option 2A    | 103                                                                                           | 7,200                                                                               | 3,400                                                                  |
| w/Design Option 3     | 103                                                                                           | 7,200                                                                               | 3,400                                                                  |
| Alternative 7         | 29                                                                                            | 4,300                                                                               | 0                                                                      |
| w/Design Option 1/2S  | 33                                                                                            | 4,900                                                                               | 0                                                                      |
| w/Design Option 2A    | 29                                                                                            | 4,300                                                                               | 0                                                                      |
| w/Design Option 3     | 29                                                                                            | 4,300                                                                               | 0                                                                      |
| Alternative 8         | 3                                                                                             | 400                                                                                 | 0                                                                      |
| w/Design Option 1/2S  | 7                                                                                             | 1,000                                                                               | 0                                                                      |
| w/Design Option 2A    | 3                                                                                             | 400                                                                                 | 0                                                                      |
| w/Design Option 3     | 3                                                                                             | 400                                                                                 | 0                                                                      |
| Alternative 9         | 87                                                                                            | 4,300                                                                               | 3,400                                                                  |
| w/Design Option 1/2S  | 91                                                                                            | 4,900                                                                               | 3,400                                                                  |
| w/Design Option 2A    | 87                                                                                            | 4,300                                                                               | 3,400                                                                  |
| w/Design Option 3     | 87                                                                                            | 4,300                                                                               | 3,400                                                                  |
| Alternative 10        | 103                                                                                           | 7,200                                                                               | 3,400                                                                  |
| w/Design Option 1/2S  | 106                                                                                           | 7,800                                                                               | 3,400                                                                  |
| w/Design Option 2A    | 103                                                                                           | 7,200                                                                               | 3,400                                                                  |
| w/Design Option 3     | 103                                                                                           | 7,200                                                                               | 3,400                                                                  |
| Alternative 11        | 99                                                                                            | 7,200                                                                               | 3,400                                                                  |
| w/Design Option 1/2S  | 103                                                                                           | 7,800                                                                               | 3,400                                                                  |
| w/Design Option 2A    | 99                                                                                            | 7,200                                                                               | 3,400                                                                  |
| w/Design Option 3     | 99                                                                                            | 7,200                                                                               | 3,400                                                                  |

Source: Wilson, Ihrig & Associates, Inc., 1991.

### Section 3.13 Noise and Vibration

Vibration impacts during construction of rail rapid transit facilities are similar to those encountered during construction of most other building projects. Except for pile driving, the groundborne vibration emitted from construction equipment should be imperceptible to the adjacent community and considerably below the recommended safe limit of 1.2 in/sec "peak particle velocity" for ordinary structures, as specified by ISO Standard ISO/TC-108/Sc-2/WG3.<sup>1</sup> Where piles are required for aerial structure or station support columns and residential buildings would be closer than 100 feet, special attention should be taken to minimize ground vibration. There is no reason to believe, at this time, that the ISO limit of 1.2 in/sec can not be met for construction of any of the proposed alternative alignments.

For sensitive building uses or older structures, the vibration standard would be approximately one-half of the normal standard. Based on observations during the ambient noise and vibration survey, there are no structurally sensitive buildings (e.g., older historic buildings) that would be affected by construction. The Horner House on Driscoll Road is located near the alignment but structural damage due to vibration impacts during construction are not expected to occur. However, vibration levels should be evaluated during the final design phase, and control measures should be included in the contract document, if appropriate.

---

<sup>1</sup> International Standards Organization, "Structural Damage from Building Vibration," Switzerland, ISO/TC-108/SC-2/WG3, 1974.

## 3.14 AIR QUALITY

### 3.14.1 SETTING AND EXISTING CONDITIONS

#### Air Quality Standards and Pollutant Characteristics

The Federal Clean Air Act of 1970 and California's Mulford-Carrell Act of 1967 established air quality standards for several pollutants. The federal standards have two tiers: primary standards designed to protect the public health, and secondary standards intended to protect the public welfare from effects such as visibility reduction, soiling, nuisance and other forms of damage. The state and federal ambient air quality standards are shown in Table 3.14-1. Pollutant characteristics are described in the text box on page 3.14-2.

**Table 3.14-1  
Federal and State Ambient Air Quality Standards**

| Pollutant                           | Averaging Time          | Federal Standard      | California Standard   |
|-------------------------------------|-------------------------|-----------------------|-----------------------|
| Ozone (O <sub>3</sub> )             | 1-hour                  | 0.12 ppm              | 0.09 ppm              |
| Carbon Monoxide (CO)                | 8-hour                  | 9.3 ppm               | 9.1 ppm               |
|                                     | 1-hour                  | 35.0 ppm              | 20.0 ppm              |
| Nitrogen Dioxide (NO <sub>2</sub> ) | Annual                  | 0.05 ppm              | --                    |
|                                     | 1-Hour                  | --                    | 0.25 ppm              |
| Sulfur Dioxide (SO <sub>2</sub> )   | Annual                  | 0.03 ppm              | --                    |
|                                     | 24-hour                 | 0.14 ppm              | 0.05 ppm              |
|                                     | 1-hour                  | --                    | 0.25 ppm              |
| Suspended Particulates (PM-10)      | Annual                  | 50 ug/m <sup>3</sup>  | 30 ug/m <sup>3</sup>  |
|                                     | 24-hour                 | 150 ug/m <sup>3</sup> | 50 ug/m <sup>3</sup>  |
| Lead (Pb)                           | 30-Day Calendar Quarter | --                    | 1.5 ug/m <sup>3</sup> |
|                                     |                         | 1.5 ug/m <sup>3</sup> | --                    |

Notes: Annual values for PM-10 differ in that the Federal Primary and Secondary Standards are based on the annual Arithmetic Mean of measurement, while the California standard is based on the Geometric Mean of measurements.

ug/m<sup>3</sup> = micrograms per cubic meter      ppm = parts per million

Source: California Air Resources Board, *California Air Quality Data*, 1989.



### Pollutant Characteristics

**Ozone** -- *the most prevalent of a class of photochemical oxidants formed in the urban atmosphere. The creation of ozone is a result of complex chemical reactions between hydrocarbons and oxides of nitrogen in the presence of sunshine. Unlike other pollutants, ozone is not released directly into the atmosphere from any sources. The major sources of oxides of nitrogen and reactive hydrocarbons, known as ozone precursors, are combustion sources such as factories and automobiles, and evaporation of solvents and fuels. The health effects of ozone are eye irritation and damage to lung tissues. Ozone also damages some materials such as rubber, and may damage plants and crops.*

**Carbon Monoxide** -- *an odorless, colorless gas that is highly toxic. It is formed by the incomplete combustion of fuels, and its main source in the Bay Area is automobiles. Carbon monoxide's health effects are related to its affinity for hemoglobin in the blood. At high concentrations, carbon monoxide reduces the amount of oxygen in the blood, causing heart difficulties in people with chronic diseases, reduced lung capacity and impaired mental abilities.*

**Nitrogen Dioxide (NO<sub>2</sub>)** -- *is a reddish-brown toxic gas which reduces visibility and is a pulmonary irritant. It is one of a group of nitrogen/oxygen compounds known as oxides of nitrogen, denoted as NO<sub>x</sub>, that result from combustion, but the only one that is toxic. However, other oxides of nitrogen, particularly nitric oxide, are converted to nitrogen dioxide in the presence of sunshine. Major sources of oxides of nitrogen are automobiles and industry.*

**Suspended Particulates (PM-10)** -- *consists of solid and liquid particles of dust, soot, aerosols and other small matter which remain suspended in the air for long periods. A portion of the suspended particulate matter in the air is due to natural sources such as wind blown dust and pollen. Man-made sources include combustion, automobiles, field burning, factories and unpaved roads. A portion of the particulate matter in urban atmospheres is also a result of photochemical processes. The effects of high concentrations of PM-10 on humans include aggravation of chronic disease and heart/lung disease symptoms. Non-health effects include reduced visibility and soiling of surfaces.*

### San Francisco Bay Area Air Basin

The Proposed Project is within the San Francisco Bay Area Air Basin (Figure 3.14-1). Within this air basin, the state and federal air quality standards for nitrogen dioxide, sulfur dioxide and lead are currently met. In at least some portions of the air basin, notably the South Bay and East Bay, standards for other pollutants such as ozone, carbon monoxide and suspended particulate (PM-10) are not met.

The entire air basin is designated "non-attainment" (standard is not met) for the state and federal ozone standards. For the federal carbon monoxide standard the "urbanized areas" within the air basin are designated non-attainment, while the urbanized areas of San Jose, Vallejo and San Francisco are designated non-attainment for the state carbon monoxide standard. The



**Figure 3.14-1  
SAN FRANCISCO BAY  
AREA AIR BASIN**

**LEGEND:**

- Gaseous pollutant or multipollutant monitoring site
- Particulate sampling only
- ◇ ARB operated site
- \* Discontinued during year
- † Site relocated

entire air basin is non-attainment for the state PM-10 standard; for the federal PM-10 standard attainment is uncertain only in Santa Clara County.<sup>1</sup>

The Bay Area Air Quality Management District (BAAQMD) operates a network of permanent monitoring sites throughout the Bay Area. The two closest sites to the project are located in Fremont on Chapel Way, and in San Jose on Fourth Street. Table 3.14-2 summarizes air quality from these two measurement sites for gaseous pollutants during the period 1987-1989. It also shows the maximum measured concentration for each pollutant, and the number of days that the most stringent state or federal standard was exceeded.

Ambient air quality standards for ozone are not met in either Fremont or San Jose. Carbon monoxide levels meet state and federal standards in the Fremont area, but exceed the state and federal standards in the downtown San Jose area.

The BAAQMD monitoring site in San Jose also measures particulate matter concentrations. While concentrations meet the federal ambient air quality standards, measured levels exceed state standards (both the 24-hour and annual).

### Regional Air Quality Planning

The U.S. Clean Air Act Amendments of 1977 required that each state identify areas within its borders that did not meet federal primary standards as non-attainment areas. The states were required to prepare a State Implementation Plan (SIP) to show how the federal standards were to be attained by 1987. The Bay Area portion of the SIP was the 1982 Bay Area Air Quality Plan. Despite considerable improvement in air quality, the Bay Area did not meet the 1987 deadline for attainment of the federal air quality standards for ozone and carbon monoxide.

The 1982 Plan contained ten Transportation Control Measures (TCMs) designed to improve regional air quality. The Warm Springs BART extension is identified as part of TCM #6, concerning the support of long-range transit improvements, thus, the project is consistent with the TCMs in the federal regional air quality plan.

In response to lawsuits, the Metropolitan Transportation Commission (MTC) adopted procedures for the review of transportation projects to delay projects deemed to have a negative air quality

---

<sup>1</sup> California Air Resources Board, *Area Designations for State and National Ambient Air Quality Standards*, Technical Support Division, November 1989.

**Table 3.14-2**  
**Air Quality Data Summary**

|                                                 | SAN JOSE          |                   |                   | FREMONT           |                   |                   |
|-------------------------------------------------|-------------------|-------------------|-------------------|-------------------|-------------------|-------------------|
|                                                 | 1987              | 1988              | 1989              | 1987              | 1988              | 1989              |
| <b><u>OZONE (O<sub>3</sub>)</u></b>             |                   |                   |                   |                   |                   |                   |
| Max. 1-hour (ppm)                               | 0.14 <sup>1</sup> | 0.21 <sup>2</sup> | 0.12 <sup>2</sup> | 0.16 <sup>1</sup> | 0.13 <sup>1</sup> | 0.13 <sup>1</sup> |
| Days Above Standard                             | 23                | 12                | 9                 | 17                | 7                 | 11                |
| <b><u>CARBON MONOXIDE (CO)</u></b>              |                   |                   |                   |                   |                   |                   |
| Max. 1-hour (ppm)                               | 12.0              | 15.0              | 19.0              | 10.0              | 9.0               | 9.0               |
| Days Above Standard                             | 0                 | 0                 | 0                 | 0                 | 0                 | 0                 |
| Max. 8-hour (ppm)                               | 7.4               | 10.4 <sup>1</sup> | 12.0 <sup>1</sup> | 5.0               | 5.3               | 5.6               |
| Days Above Standard                             | 0                 | 3                 | 6                 | 0                 | 0                 | 0                 |
| <b><u>NITROGEN DIOXIDE (NO<sub>2</sub>)</u></b> |                   |                   |                   |                   |                   |                   |
| Max. 1-hour (ppm)                               | 0.17              | 0.16              | 0.15              | 0.15              | 0.14              | 0.13              |
| Days Above Standard                             | 0                 | 0                 | 0                 | 0                 | 0                 | 0                 |

<sup>1</sup> Concentration greater than the federal primary and secondary standards of 0.12 ppm and California standard of 0.09 ppm.

<sup>2</sup> Concentration greater than the California standard of 9.1 ppm and equal to the federal primary and secondary standards of 35.0 ppm (parts per million).

Source: California Air Resources Board, *California Air Quality Data Summary*, 1987-1989.

effect. This measure had been included as a Contingency Plan measure within the 1982 Bay Area Air Quality Plan. MTC Resolution 2131 further adopted several Transportation Control Measures (TCM's) as part of the Contingency Plan, including the implementation of BART Extensions such as the Warm Springs extension.

The U.S. Clean Air Act Amendments of 1990 require that non-attainment areas develop plans and strategies that will reduce pollutants by 15 percent during the first 6 years, then 3 percent annually thereafter until the standards are met. Areas must meet the standards within 5 to 17 years, depending on the severity of the problem.

The California Clean Air Act enacted in 1989 requires local air pollution control districts to prepare air quality attainment plans for ozone and carbon monoxide by June 30, 1991. Generally, these plans must provide for district-wide emission reductions of five percent per year averaged over consecutive three-year periods. The Act also grants air districts explicit statutory authority to adopt indirect source regulations and transportation control measures, including

### 3.14 Air Quality

measures to encourage or require the use of ridesharing, transit, flexible work hours or other measures which reduce the number or length of vehicle trips.

The area-wide plan required by the California Clean Air Act has been published in draft form.<sup>1</sup> BART extensions are proposed as a Transportation Control Measure to improve regional air quality within the draft plan. The Warm Springs BART extension is included in TCM #4 of the CAP along with several other BART and Bay Area rail system extensions, thus, the project is consistent with TCMs in the proposed Clean Air Plan.

#### **Standards of Significance**

Appendix G of the CEQA Guidelines establishes that a project will normally have a significant impact on air quality if it will "violate any air quality standard, contribute substantially to an existing or projected air quality violation, or expose sensitive receptors to substantial pollutant concentrations."

For the purposes of this study a significant impact on local air quality is defined as prediction of exceedance of the state or federal standards for carbon monoxide. For regional air quality a significant impact is defined as an increase in emissions of ozone precursors or particulate matter.

The Bay Area Air Quality Management District has developed thresholds of significance for regional emission increases. The District considers increases in emissions of criteria pollutant of 150 pounds per day (550 pounds per day for carbon monoxide) to represent a significant adverse impact.<sup>2</sup>

#### **3.14.2 IMPACTS OF PROPOSED PROJECT**

##### **Direct Impacts**

**Local Air Quality.** The project would attract vehicles and redistribute traffic on the street network, affecting air quality near streets providing access to the stations. On the local scale, the pollutant of greatest interest is carbon monoxide, since it is a pollutant found in high

---

<sup>1</sup> Bay Area Air Quality Management District, *Bay Area '91 Clean Air Plan (CAP)*, April 1991.

<sup>2</sup> Bay Area Air Quality Management District, *Air Quality and Urban Development*, 1985.

concentrations only very near the emission source. Other pollutants emitted by cars are better analyzed on a regional scale.

**Intersections.** Carbon monoxide concentrations under worst-case meteorological conditions have been predicted with the Proposed Project at three intersections near each of the proposed new stations. Afternoon peak traffic volumes were applied to the CALINE-4<sup>1,2</sup> dispersion model to predict maximum 1-and 8-hour concentrations near major intersections affected by project traffic. (See Appendix F for a description of the CALINE-4 model and the assumptions used in the analysis.)

Table 3.14-3 shows the results of the intersection carbon monoxide analysis for the peak hour traffic period and the 8-hour peak traffic period near the Irvington Station for existing conditions, with base case, and with Proposed Project traffic in 1991, 1998 and 2010. Tables 3.14-4 and 3.14-5 show similar data for intersections near the proposed Warm Springs and South Warm Springs stations.

These values are to be compared to the federal 1-hour standard of 35 PPM (parts per million) and the state standard of 20 PPM, and the 8-hour standard (federal and state) of 9.0 PPM. Concentrations shown do not exceed the state or federal standards. The project would increase concentrations by up to 0.4 PPM, but predicted levels would remain well below the state and federal standards. This impact is considered to be less than significant.

The CALINE-4 model was also utilized to predict worst-case on-site carbon monoxide concentrations for persons at the bus waiting and kiss-and-ride areas. Since detailed plans for the proposed stations are not available, worst-case assumptions were made. The CALINE-4 model was used to predict carbon monoxide concentrations at the edge of a roadway with a traffic volume equal to the total peak hour bus and auto traffic that would be generated at each station. Vehicles were assumed to travel at an average speed of 10 MPH.

**Stations.** The resulting worst-case on-site 1-hour concentrations at the Irvington Station were predicted as 9.2 PPM in 1991, 8.9 PPM in 1998 and 8.7 PPM in 2010. Predicted worst-case 8-hour concentrations were 5.7 PPM in 1991, 5.5 PPM in 1998 and 5.4 PPM in 2010. Worst-

---

<sup>1</sup> P. C. Randall and A. Diamond, *Air Quality Analysis Tools (AQAT-3)*, State of California Air Resources Board, 1989.

<sup>2</sup> Paul E. Benson, *CALINE-4 - A Dispersion Model for Predicting Air Pollutant Concentration Near Roadways*, California Department of Transportation, Report No. FHWA/CA/TL-84-15, 1984.

**Table 3.14-3**  
**Worst Case Carbon Monoxide Concentrations**  
**in the Vicinity of the Irvington Station**

|                         | ----- Intersection ----- |      |                         |      |                               |      |
|-------------------------|--------------------------|------|-------------------------|------|-------------------------------|------|
|                         | Fremont/<br>Washington   |      | Driscoll/<br>Washington |      | I-680 SB Ramps/<br>Washington |      |
|                         | 1-hr                     | 8-hr | 1-hr                    | 8-hr | 1-hr                          | 8-hr |
| <b>Current (1991)*</b>  | 11.4                     | 7.1  | 12.3                    | 7.6  | 10.0                          | 6.2  |
| <b>1991</b>             |                          |      |                         |      |                               |      |
| Proposed Project        | 11.4                     | 7.1  | 12.4                    | 7.7  | 10.1                          | 6.3  |
| Alt 2                   | 11.4                     | 7.1  | 12.3                    | 7.6  | 10.1                          | 6.2  |
| Alt 3                   | 11.4                     | 7.1  | 12.3                    | 7.6  | 10.0                          | 6.2  |
| Alt's 4-5               | 11.4                     | 7.1  | 12.4                    | 7.7  | 10.1                          | 6.3  |
| Alt 11                  | 11.5                     | 7.1  | 12.5                    | 7.7  | 10.1                          | 6.3  |
| <b>1998</b>             |                          |      |                         |      |                               |      |
| Alt 1                   | 10.3                     | 6.4  | 11.1                    | 6.8  | 9.2                           | 5.7  |
| Proposed Project        | 10.5                     | 6.5  | 11.3                    | 7.0  | 9.3                           | 5.7  |
| Alt 2                   | 10.3                     | 6.4  | 11.1                    | 6.8  | 9.2                           | 5.7  |
| Alt 3                   | 10.3                     | 6.4  | 11.1                    | 6.8  | 9.2                           | 5.7  |
| Alt's 4-5               | 10.6                     | 6.5  | 11.3                    | 7.0  | 9.3                           | 5.7  |
| Alt 11                  | 10.7                     | 6.6  | 11.2                    | 7.0  | 9.3                           | 5.8  |
| <b>2010</b>             |                          |      |                         |      |                               |      |
| Alt 1                   | 11.8                     | 7.3  | 11.3                    | 7.0  | 10.3                          | 6.4  |
| Proposed Project        | 11.8                     | 7.3  | 11.4                    | 7.1  | 10.3                          | 6.4  |
| Alt 2                   | 11.8                     | 7.3  | 11.3                    | 7.0  | 10.3                          | 6.4  |
| Alt 3                   | 11.8                     | 7.3  | 11.3                    | 7.0  | 10.3                          | 6.4  |
| Alt's 4-5               | 11.8                     | 7.3  | 11.5                    | 7.1  | 10.3                          | 6.4  |
| Alt 11                  | 11.8                     | 7.3  | 11.5                    | 7.2  | 10.4                          | 6.4  |
| <b>Ambient Standard</b> | 20.0                     | 9.0  | 20.0                    | 9.0  | 20.0                          | 9.0  |

Source: Donald Ballanti, 1991

\*1991 estimated conditions

Note: Alternative 1 (No Build/Status Quo) in 1991 is the same as current conditions.

**Table 3.14-4**  
**Worst Case Carbon Monoxide Concentrations**  
**in the Vicinity of the Warm Springs Station**

|                         | ----- Intersection ----- |      |                                  |      |                    |      |
|-------------------------|--------------------------|------|----------------------------------|------|--------------------|------|
|                         | Osgood/<br>Durham        |      | S. Grimmer/<br>Osgood-W. Springs |      | Mohave/<br>Mission |      |
|                         | 1-hr                     | 8-hr | 1-hr                             | 8-hr | 1-hr               | 8-hr |
| <b>Current (1991)*</b>  | 12.8                     | 7.9  | 10.1                             | 6.3  | 14.2               | 8.8  |
| <b><u>1991</u></b>      |                          |      |                                  |      |                    |      |
| Proposed Project        | 12.9                     | 8.0  | 10.3                             | 6.4  | 14.4               | 8.9  |
| Alt 2                   | 12.8                     | 7.9  | 10.1                             | 6.3  | 14.2               | 8.8  |
| Alt 3                   | 12.8                     | 7.9  | 10.1                             | 6.3  | 14.2               | 8.8  |
| Alt's 4-5               | 12.9                     | 8.0  | 10.3                             | 6.4  | 14.4               | 8.9  |
| Alt's 6-8               | 12.9                     | 8.0  | 10.3                             | 6.4  | 14.4               | 8.9  |
| Alt 9                   | 12.9                     | 8.0  | 10.3                             | 6.4  | 14.4               | 8.9  |
| <b><u>1998</u></b>      |                          |      |                                  |      |                    |      |
| Alt 1                   | 11.9                     | 7.4  | 9.5                              | 5.9  | 13.2               | 8.2  |
| Proposed Project        | 12.0                     | 7.4  | 9.6                              | 6.0  | 13.5               | 8.3  |
| Alt 2                   | 11.9                     | 7.4  | 9.5                              | 5.9  | 13.2               | 8.2  |
| Alt 3                   | 11.9                     | 7.4  | 9.5                              | 5.9  | 13.2               | 8.2  |
| Alts 4-5                | 12.0                     | 7.4  | 9.7                              | 6.0  | 13.4               | 8.3  |
| Alts 6-8                | 12.0                     | 7.4  | 9.6                              | 6.0  | 13.5               | 8.4  |
| Alt 9                   | 12.0                     | 7.4  | 9.7                              | 6.0  | 13.4               | 8.3  |
| <b><u>2010</u></b>      |                          |      |                                  |      |                    |      |
| Alt 1                   | 12.9                     | 8.0  | 9.7                              | 6.0  | 12.9               | 8.0  |
| Proposed Project        | 13.0                     | 8.1  | 9.9                              | 6.1  | 12.9               | 8.0  |
| Alt's 4-5               | 13.0                     | 8.1  | 9.9                              | 6.1  | 13.1               | 8.2  |
| Alt's 6-8               | 13.0                     | 8.1  | 9.9                              | 6.1  | 13.2               | 8.2  |
| Alt 9                   | 13.0                     | 8.1  | 9.9                              | 6.1  | 13.2               | 8.2  |
| <b>Ambient Standard</b> | 20.0                     | 9.0  | 20.0                             | 9.0  | 20.0               | 9.0  |

Source: Donald Ballanti, 1991

\*1991 estimated conditions

Note: Alternative 1 (No Build/Status Quo) in 1991 is the same as current conditions.



**Table 3.14-5  
Worst Case Carbon Monoxide Concentrations  
in the Vicinity of the South Warm Springs Station**

|                         | ----- Intersection ----- |      |                          |      |                                  |      |
|-------------------------|--------------------------|------|--------------------------|------|----------------------------------|------|
|                         | Milmont/<br>Kato         |      | Warm Springs/<br>Milmont |      | I-880 NB Ramps/<br>Dixon Landing |      |
|                         | 1-hr                     | 8-hr | 1-hr                     | 8-hr | 1-hr                             | 8-hr |
| <b>Current (1991)*</b>  | 9.4                      | 5.8  | 12.3                     | 7.6  | 10.9                             | 6.8  |
| <b>1991</b>             |                          |      |                          |      |                                  |      |
| Proposed Project        | 9.7                      | 6.0  | 12.5                     | 7.8  | 11.3                             | 7.0  |
| Alt 2                   | 9.4                      | 5.8  | 12.3                     | 7.6  | 10.9                             | 6.8  |
| Alt 3                   | 9.4                      | 5.8  | 12.3                     | 7.6  | 10.9                             | 6.8  |
| Alt's 6-8               | 9.7                      | 6.0  | 12.5                     | 7.8  | 11.3                             | 7.0  |
| Alt 10                  | 9.9                      | 6.1  | 13.1                     | 8.1  | 11.4                             | 7.1  |
| Alt 11                  | 9.8                      | 6.1  | 12.9                     | 8.0  | 11.3                             | 7.0  |
| <b>1998</b>             |                          |      |                          |      |                                  |      |
| Alt 1                   | 8.8                      | 5.5  | 11.5                     | 7.1  | 10.2                             | 6.3  |
| Proposed Project        | 9.1                      | 5.6  | 11.6                     | 7.2  | 10.5                             | 6.5  |
| Alt 2                   | 8.8                      | 5.5  | 11.5                     | 7.1  | 10.2                             | 6.3  |
| Alt 3                   | 8.8                      | 5.5  | 11.5                     | 7.1  | 10.2                             | 6.3  |
| Alt's 6-8               | 9.1                      | 5.7  | 11.6                     | 7.2  | 10.5                             | 6.5  |
| Alt 10                  | 9.2                      | 5.7  | 12.1                     | 7.4  | 10.6                             | 6.6  |
| Alt 11                  | 9.1                      | 5.7  | 12.0                     | 7.4  | 10.5                             | 6.5  |
| <b>2010</b>             |                          |      |                          |      |                                  |      |
| Alt 1                   | 9.3                      | 5.8  | 11.0                     | 6.9  | 11.5                             | 7.1  |
| Proposed Project        | 9.7                      | 6.0  | 11.3                     | 7.0  | 11.8                             | 7.3  |
| Alt 2                   | 9.3                      | 5.8  | 11.0                     | 6.9  | 11.5                             | 7.1  |
| Alt 3                   | 9.3                      | 5.8  | 11.0                     | 6.9  | 11.5                             | 7.1  |
| Alt's 6-8               | 9.7                      | 6.0  | 11.3                     | 7.0  | 11.8                             | 7.3  |
| Alt 10                  | 9.8                      | 6.1  | 11.8                     | 7.2  | 11.9                             | 7.4  |
| Alt 11                  | 9.7                      | 6.0  | 11.6                     | 7.2  | 11.8                             | 7.3  |
| <i>Ambient Standard</i> | 20.0                     | 9.0  | 20.0                     | 9.0  | 20.0                             | 9.0  |

Source: Donald Ballanti, 1991

\*1991 estimated conditions

Note: Alternative 1 (No Build/Status Quo) in 1991 is the same as current conditions.

case on-site 1-hour concentrations at the Warm Springs station were predicted as 10.4 PPM in 1991, 10.1 PPM in 1998 and 9.9 PPM in 2010. Predicted worst-case 8-hour concentrations were 6.6 PPM in 1991, 6.3 in 1998 and 6.1 PPM and 2010.

Worst-case on-site 1-hour concentrations at the South Warm Springs Station were predicted as 9.8, 9.6 and 9.4 in 1991, 1998 and 2010, respectively. Predicted worst-case 8-hour concentrations were 6.1, 6.0 and 5.8 PPM in 1991, 1998 and 2010, respectively. Comparison of these on-site concentrations to the state and federal standards shows that predicted carbon monoxide levels would be less than the most stringent state or federal standard. This impact would be less than significant.

*Subway at Washington Boulevard.* The undergrounding of the UPRR and SPTCo railroad tracks under Washington Boulevard would place diesel electric locomotives within a 950-foot subway tunnel. Without appropriate ventilation, diesel exhaust gases and odors could accumulate and affect the Irvington BART Station and platform areas. This impact is considered potentially significant.

**Regional Air Quality.** The project would increase BART ridership and contribute to reduced vehicle trips on the regional freeway and highway system. At the same time, the proposed stations would attract new vehicle trips. While these trips would be relatively short compared to avoided freeway trips, they would generate emissions at a higher per-mile rate. A large portion of the emissions associated with a vehicle trip occur during the first few minutes of a trip when a vehicle is cold and the emission control system is not operating optimally.

The Proposed Project's electrical demands could also affect air quality, because a portion of PG&E's electrical power is generated by fossil-fueled power plants within the air basin. The increased electrical demand of the Proposed Project could increase the operation of these fossil-fueled power plants. Power plants currently emit 0.1 percent of the Organic Gases and 5.9 percent of the Nitrogen Oxides in the Bay Area Air Basin.

PG&E has no plans for new fossil-fueled power plants and forecasted new sources of supply are primarily energy conservation and efficiency programs. Therefore, the incremental increase in electrical demand caused by the project is not likely to affect fossil-fueled power plant operation or air emissions significantly.

The Metropolitan Transportation Commission's (MTC) travel model's "SMOGTRP" module was run to report year 2010 forecasts of emissions from the entire Bay Area Regional Network for the Proposed Project and alternatives. (MTC's regional travel model was also used in the

### 3.14 Air Quality

transportation impact analysis.) The SMOGTRP module is a post mode choice calculation of vehicle miles, vehicle miles traveled, average trip length and average speed for all trip types. Table 3.14-6 presents these calculated travel statistics for each alternative. Based on these travel statistics, the SMOGTRP then estimates the resultant emissions totals for several pollutants released by vehicles based upon the assumptions and methodology in MTC's Resolution 2270<sup>1</sup>, the air quality conformity procedures established by MTC. Changes in regional auto emissions resulting from implementation of the Proposed Project and alternatives in 1991, 1998 and 2010 are shown in Table 3.14-7. The year 2010 results are from the SMOGTRP output, the year 1991 and 1998 data were estimated from the SMOGTRP output by adjusting for changes in emission factors.

The SMOGTRP module does not account for new drive-to-transit trips, so the effect of these new trips must be added to the SMOGTRP results to yield the true affect of changes to the transportation system. The URBEMIS-3 (*Urban Emission*)<sup>2</sup> emissions program was utilized to estimate total daily emissions from new trips to BART stations. The URBEMIS-3 is a land use-driven program but with appropriate modification to internal parameters has been adopted for use with a transportation project such as the Proposed Project. The URBEMIS-3 program reflects the effect of factors such as average trip length, average trip speed, vehicle mix, cold start fraction and hot soak emissions. The assumptions used in the URBEMIS-3 program are described in Appendix F.

The net change in daily emissions due to new travel to BART stations is shown in Table 3.14-7. The net change in regional emission for four pollutants, relative to Alternative 1, is also shown for years 1991, 1998 and 2010. The table shows that the Proposed Project would reduce regional emissions from vehicles within the region, and would have a beneficial impact on regional air quality. The most significant reductions would be those for ozone precursors Total Organic Gases (TOG) and Nitrogen Oxides (NO<sub>x</sub>), and PM-10, since the Bay Area is considered a non-attainment area for these regional pollutants. The Proposed Project would result in an incremental decrease in the regional emission burden, causing a proportional improvement in regional air quality. The reductions in carbon monoxide (CO) on a regional basis would be beneficial as well, but this pollutant is mainly a localized pollutant. Carbon monoxide is more appropriately addressed on a local scale since concentrations are determined by the spatial distribution of emissions rather than required totals. This impact is considered beneficial.

---

<sup>1</sup> Metropolitan Transportation Commission, "Resolution 2270", adopted April 24, 1991.

<sup>2</sup> P. C. Randall and A. Diamond, *Air Quality Analysis Tools (AQAT-3)*, State of California Air Resources Board, 1989.

**Table 3.14-6  
Travel Statistics for Air Quality Analysis<sup>1</sup>  
Year 2010**

|                      | Vehicle<br>Trips<br>(in thousands) | Vehicle Miles<br>Traveled<br>(in thousands) | Average<br>Trip Length<br>(miles) | Average<br>Speed<br>(mph) |
|----------------------|------------------------------------|---------------------------------------------|-----------------------------------|---------------------------|
| Proposed Project     | 16,152                             | 103,350                                     | 6.4                               | 25.4                      |
| Alternative 1        | 16,414                             | 105,955                                     | 6.5                               | 25.4                      |
| Alternative 2        | 16,368                             | 104,557                                     | 6.4                               | 25.4                      |
| Alternative 3        | 16,152                             | 103,363                                     | 6.4                               | 25.4                      |
| Alternatives 4 and 5 | 16,152                             | 103,361                                     | 6.4                               | 25.4                      |
| Alternatives 6-8     | 16,152                             | 103,358                                     | 6.4                               | 25.4                      |
| Alternative 9        | 16,152                             | 103,368                                     | 6.4                               | 25.4                      |
| Alternative 10       | 16,152                             | 103,368                                     | 6.4                               | 25.4                      |
| Alternative 11       | 16,152                             | 103,354                                     | 6.4                               | 25.4                      |

<sup>1</sup>Input into SMOGTRP module from MTC's regional travel model.

### Cumulative Impacts

Project and cumulative traffic increases from other development in the area would affect carbon monoxide concentrations along streets accessing the site. The predicted carbon monoxide concentrations shown in Tables 3.14-3 to 3.14-5 are based on traffic projects that include cumulative traffic increases. Even with the inclusion of cumulative traffic increases, concentrations are expected to be below the state and federal ambient standards, and this impact is therefore considered to be less than significant.

The Bay Area is experiencing continued growth in population and vehicle use that will affect the emission of regional pollutants such as Organic Gases, Nitrogen Oxides and PM-10. Current projections are that regional emissions of these pollutants will decrease in the future, despite cumulative growth in population and vehicle use, due to regional programs for reducing emissions that are in place or currently being considered. Continued improvement in regional

**Table 3.14-7**  
**Regional Change in Emissions with Respect to Alternative 1 (No Project)**  
**1991, 1998 and 2010**  
**(pounds per day)**

| Alternative                   | Change to<br>Avoided Travel |         |         | Change Due to New<br>Travel to Station |        |        | Net<br>Change |         |         |
|-------------------------------|-----------------------------|---------|---------|----------------------------------------|--------|--------|---------------|---------|---------|
|                               | 1991                        | 1998    | 2010    | 1991                                   | 1998   | 2010   | 1991          | 1998    | 2010    |
| <b><u>CARBON MONOXIDE</u></b> |                             |         |         |                                        |        |        |               |         |         |
| Proposed Project              | -29,426                     | -29,120 | -24,840 | +2,880                                 | +1,893 | +2,089 | -27,146       | -22,317 | -22,751 |
| Alternative 2                 | +60                         | +45     | +40     | 0                                      | 0      | 0      | +60           | +45     | +40     |
| Alternative 3                 | -37,189                     | -27,753 | -24,780 | 0                                      | 0      | 0      | -37,189       | -27,753 | -24,780 |
| Alternatives 4-5              | -28,049                     | -23,145 | -24,000 | +1,735                                 | +1,452 | +1,615 | -26,314       | -21,691 | -22,350 |
| Alternatives 6-8              | -28,082                     | -23,170 | -24,000 | +1,788                                 | +1,487 | +1,655 | -26,294       | -21,683 | -22,345 |
| Alternative 9                 | -28,251                     | -23,543 | -24,760 | +1,190                                 | +1,001 | +1,129 | -27,061       | -22,542 | -23,631 |
| Alternative 10                | -29,264                     | -23,987 | -24,760 | +1,969                                 | +1,632 | +1,808 | -27,295       | -22,355 | -23,952 |
| Alternative 11                | -30,539                     | -24,629 | -24,820 | +2,311                                 | +1,886 | +2,038 | -28,228       | -22,743 | -23,782 |
| <b><u>HYDROCARBONS</u></b>    |                             |         |         |                                        |        |        |               |         |         |
| Proposed Project              | -4,379                      | -3,220  | -3,180  | +227                                   | +137   | +141   | -4,152        | -3,083  | -3,039  |
| Alternative 2                 | +70                         | +47     | +40     | 0                                      | 0      | 0      | +70           | +47     | +40     |
| Alternative 3                 | -4,975                      | -3,691  | -3,160  | 0                                      | 0      | 0      | -4,975        | -3,691  | -3,160  |
| Alternatives 4-5              | -4,282                      | -3,177  | -3,160  | +173                                   | +105   | +109   | -4,109        | -3,072  | -3,051  |
| Alternatives 6-8              | -4,314                      | -3,201  | -3,180  | +178                                   | +107   | +112   | -4,136        | -3,098  | -3,068  |
| Alternative 9                 | -4,195                      | -3,133  | -3,160  | +118                                   | +72    | +76    | -4,077        | -3,061  | -3,084  |
| Alternative 10                | -4,342                      | -3,193  | -3,160  | +196                                   | +118   | +122   | -4,146        | -3,075  | -3,038  |
| Alternative 11                | -4,540                      | -3,290  | -3,180  | +229                                   | +136   | +138   | -4,311        | -3,154  | -3,042  |
| <b><u>NITROGEN OXIDES</u></b> |                             |         |         |                                        |        |        |               |         |         |
| Proposed Project              | -3,546                      | -3,119  | -3,420  | +135                                   | +102   | +113   | -3,411        | -3,017  | -3,307  |
| Alternative 2                 | -973                        | -778    | -740    | 0                                      | 0      | 0      | -973          | -778    | -740    |
| Alternative 3                 | -4,497                      | -3,598  | -3,420  | 0                                      | 0      | 0      | -4,497        | -3,598  | -3,420  |
| Alternatives 4-5              | -3,503                      | -3,098  | -3,420  | +102                                   | +78    | +87    | -3,401        | -3,020  | -3,333  |
| Alternatives 6-8              | -3,507                      | -3,101  | -3,420  | +106                                   | +80    | +89    | -3,401        | -3,021  | -3,331  |
| Alternative 9                 | -3,429                      | -3,054  | -3,420  | +70                                    | +54    | +61    | -3,359        | -3,000  | -3,359  |
| Alternative 10                | -3,547                      | -3,112  | -3,420  | +116                                   | +88    | +98    | -3,431        | -3,024  | -3,322  |
| Alternative 11                | -3,696                      | -3,187  | -3,420  | +230                                   | +102   | +110   | -3,466        | -3,085  | -3,310  |
| <b><u>PM-10</u></b>           |                             |         |         |                                        |        |        |               |         |         |
| Proposed Project              | -1,840                      | -1,477  | -1,540  | +10                                    | +10    | +12    | -1,830        | -1,470  | -1,528  |
| Alternative 2                 | -1,272                      | -929    | -840    | 0                                      | 0      | 0      | -1,272        | -929    | -840    |
| Alternative 3                 | -2,334                      | -1,704  | -1,540  | 0                                      | 0      | 0      | -2,334        | -1,704  | -1,540  |
| Alternatives 4-5              | -1,817                      | -1,467  | -1,540  | +8                                     | +8     | +9     | -1,809        | -1,459  | -1,531  |
| Alternatives 6-8              | -1,818                      | -1,468  | -1,540  | +8                                     | +8     | +9     | -1,810        | -1,460  | -1,531  |
| Alternative 9                 | -1,778                      | -1,446  | -1,540  | +5                                     | +5     | +6     | -1,773        | -1,461  | -1,534  |
| Alternative 10                | -1,842                      | -1,474  | -1,540  | +9                                     | +9     | +10    | -1,833        | -1,465  | -1,530  |
| Alternative 11                | -1,916                      | -1,509  | -1,540  | +10                                    | +10    | +11    | -1,906        | -1,499  | -1,529  |

Source: Donald Ballanti, 1991.

air quality is projected through the year 2000, although attainment of all air quality standards throughout the entire Bay Area Air Basin is not projected by the year 2000.<sup>1</sup>

### Construction Period Impacts

Construction activities are a source of organic gas emissions. Solvents in adhesives, non-waterbase paints, thinners, some insulating materials and caulking materials would evaporate into the atmosphere and would participate in the photochemical reaction that creates urban ozone. Asphalt used in paving is also a source of organic gases for a short time after its application. These relatively small and intermittent emissions would represent a significant impact.

Construction equipment would be source of exhaust emissions during period of construction activity. Diesel-powered equipment typically used in construction emits small amounts of carbon monoxide, hydrocarbons, oxides of nitrogen and PM-10. The actual exhaust emission from construction on any given day would depend on the number, type and hours of operation of for each equipment type.

Construction air quality impacts would be caused by dust caused by equipment and vehicles. Fugitive dust is emitted both during construction activity and as a result of wind erosion over exposed earth surfaces. Clearing and grading activities comprise the major source of construction dust emissions, but traffic and general disturbance of the soil also generate significant dust emissions. The effects of construction activities would be increased dustfall and locally elevated levels of suspended particulates.

Construction dust impacts are extremely variable, being dependent on windspeed, soil type, soil moisture, the type of construction activity and acreage affected by construction activity. The types and frequency of dust control measures also partially determines emissions. A rough estimate of construction particulate emissions is 0.3 tons/acre/month, assuming 50 percent of the total emission is PM-10 and a typical program of watering with a 50 percent control efficiency. Localized exceedances of the PM-10 standards and dust annoyance could conceivably occur at some time during the construction period along the 7.8-mile length of the project, although annoyance is only likely where construction activities occur upwind of developed land uses. This impact is considered potentially significant.

---

<sup>1</sup> Bay Area Air Quality Management District, 1991, *Draft Bay Area 91' Clean Air Plan (CAP)*, April.

### **Mitigation**

**Diesel Train Exhausts at the Irvington Station.** The ventilation system proposed for the freight rail subways under Washington Street should be adequate to handle the expected number of freight rail trains. Exhausts from the subways should be located as far as possible from the Irvington Station.

**Construction Dust Impacts.** Construction dust impacts can be minimized by specifying dust control requirements in construction contracts. These requirements should include:

- Suspension of any earthmoving or other dust-producing activities during periods of high winds.
- Provision of equipment and manpower for watering of all exposed or disturbed soil surfaces at least twice daily, including weekends and holidays. An appropriate dust palliative or suppressant, added to water before application, should be utilized.
- Water or cover stockpiles of debris, soil, sand or other materials that can be blown by the wind.
- Sweep construction area and adjacent streets of all mud and debris, since this material can be pulverized and later resuspended by vehicle traffic.
- Limit the speed of all construction vehicles to 15 miles per hour while on site.

### **Residual Impacts after Mitigation**

With proper design of the ventilation system for the freight rail subways under Washington Boulevard, the potential for diesel exhaust or odor impacts on the Irvington Station would be eliminated, and the impact reduced to a less than significant level.

The use of watering alone for dust control is estimated to reduce dust emissions by about 50 percent. The combined effect of the above mitigation measures, including the use of a dust suppressant, would have a control efficiency of 70 to 80 percent, which is expected to reduce this impact to a less than significant level.

**3.14.3 IMPACTS OF DESIGN OPTIONS**

The design options being considered would not change the local or regional direct impacts of the Proposed Project. Construction air quality impacts, however, could be changed by the design options being considered.

**Design Option 1** would greatly increase the potential for construction dust impacts within Fremont Central Park, since it would involve much more excavation and earth moving.

**Design Option 2A** would involve less excavation and would be located further to the east, thus reducing construction dust impacts upon Fremont Central Park. However, this design option would place construction closer to residences located east of the UPRR tracks.

**Design Option 2S** would greatly increase the potential for construction dust impacts since it would involve much more excavation and earth moving. Changing the alignment to the east would reduce somewhat the impacts of construction dust on Fremont Central Park, but would increase impacts at residences located east of the Union Pacific Railroad tracks.

**Design Option 3** would have a construction dust generation similar to that of the Proposed Project. The alignment for this design option would place it closer to residences east of the UPRR tracks, so impacts at these residences would be somewhat higher.

**3.14.4 IMPACTS OF ALTERNATIVE 1: No Project and No Transportation Improvements (status quo)**

This alternative would have no air quality impacts (adverse or beneficial). This alternative would be inconsistent both with the Contingency Plan Transportation Control Measures adopted by the Metropolitan Transportation Commissions as part of the *1982 Bay Area Air Quality Plan* developed pursuant to the Federal Clean Air Act and Draft *Bay Area '91 Clean Air Plan (CAP)* required by the California Clean Air Act. Both the federal and state Plans include BART extensions as Transportation Control Measures designed to improve regional air quality.



**3.14.5 IMPACTS OF ALTERNATIVE 2: No Project, Programmed Transportation Improvements**

This alternative would have no impact on local carbon monoxide levels in the vicinity of the project, but local increases in carbon monoxide concentrations could occur near improved highway segments.

Table 3.14-6 shows that this alternative would have a mixed impact on regional emissions. Emission reductions are projected for nitrogen oxides and PM-10, while small increases in regional carbon monoxide and hydrocarbons emissions are predicted. Since hydrocarbons and oxides of nitrogen are ozone precursors, it is difficult to predict whether this alternative would have a positive or negative effect on regional ozone levels. The effect of this alternative on regional PM-10 levels would be beneficial.

This alternative would be inconsistent both with the Contingency Plan Transportation Control Measures adopted by the Metropolitan Transportation Commissions as part of the *1982 Bay Area Air Quality Plan* developed pursuant to the Federal Clean Air Act and Draft *Bay Area '91 Clean Air Plan (CAP)* required by the California Clean Air Act. Both the federal and state Plans include BART extensions as Transportation Control Measures designed to improve regional air quality.

**3.14.6 IMPACTS OF ALTERNATIVE 3: Transportation Systems Management (TSM)**

**Direct Impacts**

This alternative would have no impact on local carbon monoxide levels in the vicinity of the project, but local increases in carbon monoxide concentrations could occur near improved highway segments.

Table 3.14-6 shows that this alternative would have a beneficial impact on regional emissions. Regional emission reductions are projected to be similar to those for the Proposed Project. The most significant reductions would be those for ozone precursors Total Organic Gases (TOG) and Oxides of Nitrogen (NO<sub>x</sub>), and PM-10, since the Bay Area is considered a non-attainment area for these regional pollutants. This impact is considered beneficial.

### 3.14 Air Quality

This alternative would be partially inconsistent with the Contingency Plan Transportation Control Measures adopted by the Metropolitan Transportation Commissions as part of the *1982 Bay Area Air Quality Plan* developed pursuant to the Federal Clean Air Act and Draft *Bay Area '91 Clean Air Plan (CAP)* required by the California Clean Air Act. Both the federal and state plans include BART extensions as Transportation Control Measures designed to improve regional air quality. Other portions of this alternative, such as the I-880 and I-680 HOV lanes are identified as Transportation Control Measures (TCMs) within state and federal air quality planning programs.

#### **Cumulative Impacts**

There are no identified cumulative impacts of this alternative.

#### **Construction Period Impacts**

The construction period impacts of this alternative would be similar in nature to those of the Proposed Project, although the location of these impacts would be entirely different. Construction PM-10 and dust impact potential would exist for a period of several months along the improved sections of I-880 and I-680. This impact is considered potentially significant.

#### **Mitigation Measures**

**Construction Dust Impacts.** Mitigation measures for construction under this alternative would be identical to that for the Proposed Project.

#### **Residual Impacts after Mitigation**

The use of watering alone for dust control is estimated to reduce dust emissions by about 50 percent. The combined effect of the above mitigation measures, including the use of a dust suppressant, would have a control efficiency of 70 to 80 percent, which is expected to reduce this impact to a less than significant level.

**3.14.7 IMPACTS OF ALTERNATIVE 4: A 5-4 Mile BART Extension with Two Stations, and Relocated Railroad****Direct Impacts**

**Local Air Quality.** Table 3.14-3 shows the results of the intersection carbon monoxide analysis for the peak hour traffic period and the 8-hour peak traffic period near the Irvington Station for existing, 1998 and 2010 conditions. Table 3.14-4 shows similar data for intersections near the proposed Warm Springs Station. Compared to the Alternative 1 (Status Quo), Alternative 4 would increase carbon monoxide concentrations by up to 0.3 PPM in 1998 and 0.2 PPM in 2010, but predicted levels would remain well below the state and federal standards. This impact is considered less than significant.

Potential diesel exhaust impacts due to the undergrounding of the UPRR and SPTCo tracks under Washington Boulevard would be similar to those for the Proposed Project. This impact is considered potentially significant.

**Regional Air Quality**

Table 3.14-6 shows that this alternative would have a beneficial impact on regional emissions. Regional emission reductions are projected to be similar to those for the Proposed Project. The most significant reductions would be those for ozone precursors Total Organic Gases (TOG) and Oxides of Nitrogen (NOx), and PM-10, since the Bay Area is considered a non-attainment area for these regional pollutants. This impact is considered beneficial.

**Cumulative Impacts**

The predicted carbon monoxide concentrations shown in Tables 3.14-3 and 3.14-4 for this alternative are based on traffic projects that include cumulative traffic increases. Even with the inclusion of cumulative traffic increases, concentrations are expected to be below the state and federal ambient standards, and this impact is therefore considered to be less than significant.

**Construction Period Impacts**

The construction period impacts of this alternative would be similar in nature to those of the Proposed Project, although less extensive because the extension would be shorter. Localized exceedances of the PM-10 standards and dust annoyance could conceivably occur at some time

### 3.14 Air Quality

during the construction period along the 5.4-mile length of the project, although annoyance is only likely where construction activities occur upwind of developed land uses. This impact is considered potentially significant.

#### **Mitigation Measures**

**Diesel Train Exhausts at the Irvington Station.** Mitigation for this impact would be identical to that for the Proposed Project.

**Construction Dust Impacts.** Mitigation measures for construction under this alternative would be identical to that for the Proposed Project.

#### **Residual Impacts after Mitigation**

With proper design of the ventilation system for the freight train subways under Washington Street, the potential for diesel exhaust or odor impacts on the Irvington Station would be eliminated, and this impact reduced to a less than significant level.

The use of watering alone for dust control is estimated to reduce dust emissions by about 50 percent. The combined effect of the above mitigation measures, including the use of a dust suppressant, would have a control efficiency of 70-80 percent, which is expected to reduce this impact to a less than significant level.

### **3.14-8 IMPACTS OF ALTERNATIVE 5: A 5.4-Mile BART Extension with Two Stations**

#### **Direct Impacts**

**Local Air Quality.** Table 3.14-3 shows the results of the intersection carbon monoxide analysis for the peak hour traffic period and the 8-hour peak traffic period near the Irvington Station for existing, 1998 and 2010 conditions. Table 3.14-4 shows similar data for intersections near the proposed Warm Springs Station.

Compared to Alternative 1 (No Build), this alternative would increase concentrations of carbon monoxide by up to 0.3 PPM in 1998 and 0.2 PPM in 2010, but predicted levels would remain well below the state and federal standards. This impact is considered to be less than significant.

Potential diesel exhaust impacts due to the undergrounding of the Union Pacific and Southern Pacific railroad tracks under Washington Boulevard would be similar to those for the Proposed Project. This impact is considered potentially significant.

### **Regional Air Quality**

Table 3.14-6 shows that this alternative would have a beneficial impact on regional emissions. Regional emission reductions are projected to be similar to those for the Proposed Project. The most significant reductions would be those for ozone precursors Total Organic Gases (TOG) and Oxides of Nitrogen (NO<sub>x</sub>), and PM-10, since the Bay Area is considered a non-attainment area for these regional pollutants. This impact is considered beneficial.

### **Cumulative Impacts**

The predicted carbon monoxide concentrations shown in Tables 3.14-3 and 3.14-4 for this alternative are based on traffic projects that include cumulative traffic increases. Even with the inclusion of cumulative traffic increases, concentrations are expected to be below the state and federal ambient standards, and this impact is therefore considered to be less than significant.

### **Construction Period Impacts**

The construction period impacts of this alternative would be similar in nature to those of the Proposed Project, although less extensive due to its shorter length. Localized exceedances of the PM-10 standards and dust nuisance could conceivably occur at some time during the construction period along the 5.4-mile length of the project, although nuisance is only likely where construction activities occur upwind of developed land uses. This impact is considered potentially significant.

### **Mitigation Measures**

**Diesel Train Exhausts at the Irvington Station.** Mitigation for this impact would be identical to that for the Proposed Project.

**Construction Dust Impacts.** Mitigation measures for construction under this alternative would be identical to that for the Proposed Project.

**Residual Impacts after Mitigation**

With proper design of the ventilation system for the freight train subways under Washington Street, the potential for diesel exhaust or odor impacts on the Irvington Station would be eliminated, and this impact reduced to a less than significant level.

The use of watering alone for dust control is estimated to reduce dust emissions by about 50 percent. The combined effect of the above mitigation measures, including the use of a dust suppressant, would have a control efficiency of 70-80 percent, which is expected to reduce this impact to a less than significant level.

**3.14.9 IMPACTS OF ALTERNATIVE 6: A 7.8-Mile BART Extension with Two Stations (No Irvington Station)****Direct Impacts**

**Local Air Quality.** Table 3.14-4 shows the results of the intersection carbon monoxide analysis for the peak hour traffic period and the 8-hour peak traffic period near the Warm Springs Station for existing, 1998 and 2010 conditions with base case traffic and traffic with this alternative. Table 3.14-5 shows similar data for intersections near the proposed South Warm Springs Station.

Compared to Alternative 1 (No Build), Alternative 6 would increase carbon monoxide concentrations by up to 0.3 PPM in 1998 and 0.4 PPM in 2010, but predicted levels would remain well below the state and federal standards. This impact would be less than significant.

**Regional Air Quality**

Table 3.14-6 shows that this alternative would have a beneficial impact on regional emissions. Regional emission reductions are projected to be similar to those for the Proposed Project. The most significant reductions would be those for ozone precursors Total Organic Gases (TOG) and Oxides of Nitrogen (NOx), and PM-10, since the Bay Area is considered a non-attainment area for these regional pollutants. This impact is considered beneficial.

### **Cumulative Impacts**

The predicted carbon monoxide concentrations shown in Tables 3.14-4 and 3.14-5 for this alternative are based on traffic projects that include cumulative traffic increases. Even with the inclusion of cumulative traffic increases, concentrations are expected to be below the state and federal ambient standards, and this impact is therefore considered to be less than significant.

### **Construction Period Impacts**

The construction period impacts of this alternative would be similar to that of the Proposed Project. This impact is considered potentially significant.

### **Mitigation Measures**

**Construction Dust Impacts.** Mitigation measures for construction under this alternative would be identical to that for the Proposed Project.

### **Residual Impacts after Mitigation**

The use of watering alone for dust control is estimated to reduce dust emissions by about 50 percent. The combined effect of the above mitigation measures, including the use of a dust suppressant, would have a control efficiency of 70-80 percent, which is expected to reduce this impact to a less than significant level.

## **3.14.10 IMPACTS OF ALTERNATIVE 7: A 7.8-Mile BART Extension with Two Stations (No Irvington Station)**

### **Direct Impacts**

**Local Air Quality.** Table 3.14-4 shows the results of the intersection carbon monoxide analysis for the peak hour traffic period and the 8-hour peak traffic period near the Warm Springs Station for existing, 1998 and 2010 conditions, with base case traffic and traffic with this alternative. Table 3.14-5 shows similar data for intersections near the proposed South Warm Springs Station.

### 3.14 Air Quality

Compared to Alternative 1, Alternative 7 would increase carbon monoxide concentrations by up to 0.3 PPM in 1998 and 0.4 PPM in 2010, but predicted levels would remain well below the state and federal standards. This impact is considered to be less than significant.

#### **Regional Air Quality**

Table 3.14-6 shows that this alternative would have a beneficial impact on regional emissions. Regional emission reductions are projected to be similar to those for the Proposed Project. The most significant reductions would be those for ozone precursors, Total Organic Gases (TOG) and Oxides of Nitrogen (NO<sub>x</sub>), and PM-10, since the Bay Area is considered a non-attainment area for these regional pollutants. This impact is considered beneficial.

#### **Cumulative Impacts**

The predicted carbon monoxide concentrations shown in Tables 3.14-4 and 3.14-5 for this alternative are based on traffic projects that include cumulative traffic increases. Even with the inclusion of cumulative traffic increases, concentrations are expected to be below the state and federal ambient standards, and this impact is therefore considered to be less than significant.

#### **Construction Period Impacts**

The construction period impacts of this alternative would be similar to that of the Proposed Project. This impact is considered potentially significant.

#### **Mitigation Measures**

**Construction Dust Impacts.** Mitigation measures for construction under this alternative would be identical to that for the Proposed Project.

#### **Residual Impacts after Mitigation**

The use of watering alone for dust control is estimated to reduce dust emissions by about 50 percent. The combined effect of the above mitigation measures, including the use of a dust suppressant, would have a control efficiency of 70-80 percent, which is expected to reduce this impact to a less than significant level.



**3.14.11 IMPACTS OF ALTERNATIVE 8: A 7.8-Mile BART Extension along Osgood Road and Warm Springs Boulevard, with Two Stations (No Irvington Station)**

**Direct Impacts**

**Local Air Quality.** Table 3.14-4 shows the results of the intersection carbon monoxide analysis for the peak hour traffic period and the 8-hour peak traffic period near the Warm Springs Station for existing, 1998 and 2010 conditions, with base case traffic and traffic this alternative. Table 3.14-5 shows similar data for intersections near the proposed South Warm Springs station.

Compared to Alternative 1, Alternative 8 would increase carbon monoxide concentrations by up to 0.3 PPM in 1998 and 0.4 PPM in 2010, but predicted levels would remain well below the state and federal standards. This impact is considered to be less than significant.

**Regional Air Quality**

Table 3.14-6 shows that this alternative would have a beneficial impact on regional emissions. Regional emission reductions are projected to be similar to those for the Proposed Project. The most significant reductions would be those for ozone precursors Total Organic Gases (TOG) and Oxides of Nitrogen (NOx), and PM-10, since the Bay Area is considered a non-attainment area for these regional pollutants. This impact is considered beneficial.

**Cumulative Impacts**

The predicted carbon monoxide concentrations shown in Tables 3.14-4 and 3.14-5 for this alternative are based on traffic projects that include cumulative traffic increases. Even with the inclusion of cumulative traffic increases, carbon monoxide concentrations are expected to be below the state and federal ambient standards, and this impact is therefore considered to be less than significant.

**Construction Period Impacts**

The construction period impacts of this alternative would be similar to that of the Proposed Project. This impact is considered potentially significant.

### **Mitigation Measures**

**Construction Dust Impacts.** Mitigation measures for construction under this alternative would be identical to that for the Proposed Project.

### **Residual Impacts after Mitigation**

The use of watering alone for dust control is estimated to reduce dust emissions by about 50 percent. The combined effect of the above mitigation measures, including the use of a dust suppressant, would have a control efficiency of 70-80 percent, which is expected to reduce this impact to a less than significant level.

### **3.14.12 IMPACTS OF ALTERNATIVE 9: A 5.4-Mile BART Extension with One Station (Warm Springs)**

#### **Direct Impacts**

**Local Air Quality.** Table 3.14-4 shows the results of the intersection carbon monoxide analysis for the peak hour traffic period and the 8-hour peak traffic period near the Warm Springs Station for existing conditions, 1998 and 2010 conditions, with base case traffic and traffic with this alternative.

Compared to Alternative 1, Alternative 9 would increase carbon monoxide concentrations by up to 0.2 PPM in 1998 and 0.3 PPM in 2010, but predicted levels would remain well below the state and federal standards. This impact is considered less than significant.

#### **Regional Air Quality**

Table 3.14-6 shows that this alternative would have a beneficial impact on regional emissions. Regional emission reductions are projected to be similar to those for the Proposed Project. The most significant reductions would be those for ozone precursors Total Organic Gases (TOG) and Oxides of Nitrogen (NO<sub>x</sub>), and PM-10, since the Bay Area is considered a non-attainment area for these regional pollutants. This impact is considered beneficial.

**Cumulative Impacts**

The predicted carbon monoxide concentrations shown in Table 3.14-4 for this alternative are based on traffic projects that include cumulative traffic increases. Even with the inclusion of cumulative traffic increases, concentrations are expected to be below the state and federal ambient standards, and this impact is therefore considered to be less than significant.

**Construction Period Impacts**

The construction period impacts of this alternative would be similar in nature to those of the Proposed Project, although less extensive due to its shorter alignment. Localized exceedances of the PM-10 standards and dust annoyance could conceivably occur at some time during the construction period along the 5.4-mile length of Alternative 9's alignment, although annoyance is only likely where construction activities occur upwind of developed land uses. This impact is considered potentially significant.

**Mitigation Measures**

**Construction Dust Impacts.** Mitigation measures for construction under this alternative would be identical to that for the Proposed Project.

**Residual Impacts after Mitigation**

The use of watering alone for dust control is estimated to reduce dust emissions by about 50 percent. The combined effect of the above mitigation measures, including the use of a dust suppressant, would have a control efficiency of 70 to 80 percent, which is expected to reduce this impact to a less than significant level.

**3.14.13 IMPACTS OF ALTERNATIVE 10: A 7.8-Mile BART Extension with One Station (South Warm Springs)****Direct Impacts**

**Local Air Quality.** Table 3.14-5 shows the results of the intersection carbon monoxide analysis for the peak hour traffic period and the 8-hour peak traffic period near the South Warm

Springs Station for existing, 1998 and 2010 conditions, with base case traffic and traffic with this alternative.

Compared to Alternative 1, Alternative 10 would increase carbon monoxide concentrations by up to 0.5 PPM in 1998 and 0.8 PPM in 2010, but predicted levels would remain well below the state and federal standards. This impact is considered to be less than significant.

### **Regional Air Quality**

Table 3.14-6 shows that this alternative would have a beneficial impact on regional emissions. Regional emission reductions are projected to be similar to those for the Proposed Project. The most significant reductions would be those for ozone precursors Total Organic Gases (TOG) and Oxides of Nitrogen (NOx), and PM-10, since the Bay Area is considered a non-attainment area for these regional pollutants. This impact is considered beneficial.

### **Cumulative Impacts**

The predicted carbon monoxide concentrations shown in Table 3.14-5 for this alternative are based on traffic projects that include cumulative traffic increases. Even with the inclusion of cumulative traffic increases, concentrations are expected to be below the state and federal ambient standards, and this impact is therefore considered to be less than significant.

### **Construction Period Impacts**

The construction period impacts of this alternative would be similar to that of the Proposed Project. This impact is considered potentially significant.

### **Mitigation Measures**

**Construction Dust Impacts.** Mitigation measures for construction under this alternative would be identical to that for the Proposed Project.

### **Residual Impacts after Mitigation**

The use of watering alone for dust control is estimated to reduce dust emissions by about 50 percent. The combined effect of the above mitigation measures, including the use of a dust

## 3.14 Air Quality

suppressant, would have a control efficiency of 70-80 percent, which is expected to reduce this impact to a less than significant level.

### **3.14.14 IMPACTS OF ALTERNATIVE 11: A 7.8-Mile BART Extension with Two Stations (No Warm Springs Station)**

#### **Direct Impacts**

**Local Air Quality** Table 3.14-3 shows the results of the intersection carbon monoxide analysis for the peak hour traffic period and the 8-hour peak traffic period near the Irvington Station for existing, 1998 and 2010 conditions with base case traffic and traffic with this alternative. Table 3.14-5 shows similar data for the South Warm Springs Station.

Compared to Alternative 1, Alternative 11 would increase carbon monoxide concentrations by up to 0.4 PPM in 1998 and up to 0.2 PPM in 2010, but predicted levels would remain well below the state and federal standards. This impact is considered less than significant.

#### **Regional Air Quality**

Table 3.14-6 shows that Alternative 11 would have a beneficial impact on regional emissions. Regional emission reductions are projected to be similar to those for the Proposed Project. The most significant reductions would be those for ozone precursors Total Organic Gases (TOG) and Oxides of Nitrogen (NOx), and PM-10, since the Bay Area is considered a non-attainment area for these regional pollutants. This impact is considered beneficial.

#### **Cumulative Impacts**

The predicted carbon monoxide concentrations shown in Tables 3.14-3 and 3.14-5 for this alternative are based on traffic projects that include cumulative traffic increases. Even with the inclusion of cumulative traffic increases, concentrations are expected to be below the state and federal ambient standards, and this impact is therefore considered to be less than significant.

#### **Construction Period Impacts**

The construction period impacts of this alternative would be similar to that of the Proposed Project. This impact is considered potentially significant.

**Mitigation Measures**

**Construction Dust Impacts** Mitigation measures for construction under this alternative would be identical to that for the Proposed Project.

**Residual Impacts after Mitigation**

The use of watering alone for dust control is estimated to reduce dust emissions by about 50 percent. The combined effect of the above mitigation measures, including the use of a dust suppressant, would have a control efficiency of 70 to 80 percent, which is expected to reduce this impact to a less than significant level.

## 3.15 ENERGY

### 3.15.1 SETTING

The current energy needs of the state of California are met almost exclusively through consumption of nonrenewable resources. Petroleum products provide approximately 57 percent of this energy while natural gas provides 26 percent, hydropower 6 percent, nuclear power 5 percent, and geothermal and coal each provide 3 percent.<sup>1</sup> The energy needs of the state's transportation sector account for the largest portion of this energy consumption; while 50 percent of energy is consumed in the transportation sector, 9 percent is consumed in the commercial sector, 12 percent in the residential sector, and 29 percent in the industrial sector.<sup>2</sup> Of the energy consumed in the transportation sector, autos consume 44 percent while trucks consume 20 percent, aircraft 14 percent, marine traffic 13 percent, transit (including rail freight) 2 percent, and other modes 7 percent.<sup>3</sup>

One goal of energy analysts and transportation planners in recent years has been to reduce the large amount of energy consumed in the transportation sector, particularly the large portion which is consumed by automobiles. Conservation strategies have included the improvement of the efficiency of various modes of transportation, and the U.S. Environmental Protection Agency has imposed fleet requirements in order to ensure increased efficiency in personal automobiles over time. In addition, many transportation agencies responsible for managing road systems are planning transportation management strategies that encourage higher occupancy of vehicles and improved connections with existing transit systems. Other energy conservation efforts in the transportation sector include traffic flow improvements, improved construction and maintenance of transportation infrastructure, and reduced speed limits.

An important component of any strategy to reduce reliance on automobiles is the construction of new mass transit systems and the expansion of existing mass transit systems. Mass transit systems can provide energy savings because of their ability to transport people much more efficiently than private automobiles. For example, transporting 100,000 people on the BART system for a given distance requires the energy equivalent of approximately 11,000 gallons of

---

<sup>1</sup> Pacific Data Resources, *California Almanac*, 1991, p. 364

<sup>2</sup> Ibid.

<sup>3</sup> Caltrans, *Energy and Transportation Systems*, July 1983, p.12.

gasoline while transporting the same number of people an equivalent distance in automobiles uses about 27,000 gallons of gasoline, a 145 percent greater energy requirement.<sup>1</sup>

Electrical energy is supplied throughout the project area by the Pacific Gas and Electric Company. The utility has a dependable capacity of approximately 18,950 megawatts and generates power from a variety of sources including oil and gas fired plants (36 percent), hydroelectric (23 percent), nuclear (11 percent), co-generation (10 percent), pumped storage (6 percent), geothermal (5 percent) and others (9 percent).<sup>2</sup>

### 3.15.2 IMPACTS

#### Criteria of Significance

A significant adverse energy impact would occur if a project were to result in a significant commitment of nonrenewable energy resources during its initial and continuing phases<sup>3</sup> or if it were to discourage the use of efficient transportation alternatives<sup>4</sup> or if it were to result in significant effects on local and regional energy supplies or on requirements for additional capacity.<sup>5</sup>

#### Direct Impacts

The relative energy requirements of the proposed project and the various alternatives for the Warm Springs Extension were estimated. Table 3.15-1 summarizes the results of the analysis of the direct energy consumption of the Proposed Project and Alternatives 4 through 11. Alternatives 1 through 3 would not involve a BART extension and therefore would not require any additional commitments of energy resources for the construction or operation of the Proposed Project and BART alternatives. The following energy consumption categories are considered in the calculations:

---

<sup>1</sup> This illustrative comparison assumes an average trip length of 6.8 miles, a BART occupancy of 25.2 persons per car, electrical requirement of 4.9 Kwh per car-mile, and an electrical generation/transmission efficiency of 30%. For cars, it assumes an average occupancy of 1.2 persons per car and efficiency of 21 miles per gallon.

<sup>2</sup> California Energy Commission, *Bi-Annual Energy Report*, 1990, Table B-1, revised, p. B-5

<sup>3</sup> CEQA Guidelines, Section 15126 (f).

<sup>4</sup> *ibid.*, Appendix F (II, C, 6)

<sup>5</sup> *ibid.*, Appendix F, (II.C.2)



**Table 3.15-1**  
**Warm Springs Extension**  
**Annual Energy Consumption**  
**(Billions of BTUs)<sup>1</sup>**

| Alternative      | (1)<br>BART<br>Station<br>Power | (2)<br>BART<br>Maintenance<br>Power | (3)<br>BART<br>Traction<br>Power | (4)<br>Annual<br>BART Power<br>Consumption |
|------------------|---------------------------------|-------------------------------------|----------------------------------|--------------------------------------------|
| Proposed Project | 43                              | 9.9                                 | 78                               | 131                                        |
| Alternative 4    | 31                              | 6.4                                 | 50                               | 88                                         |
| Alternative 5    | 31                              | 6.4                                 | 50                               | 88                                         |
| Alternative 6    | 23                              | 9.9                                 | 78                               | 111                                        |
| Alternative 7    | 23                              | 9.9                                 | 78                               | 111                                        |
| Alternative 8    | 23                              | 9.9                                 | 78                               | 111                                        |
| Alternative 9    | 12                              | 9.9                                 | 78                               | 100                                        |
| Alternative 10   | 12                              | 9.9                                 | 78                               | 100                                        |
| Alternative 11   | 23                              | 9.9                                 | 78                               | 111                                        |

<sup>1</sup>A BTU (British Thermal Unit) is the quantity of heat required to raise the temperature of one pound of water one degree Fahrenheit.

Source: Donaldson Associates, 1991.

### 3.15 Energy

- Column 1: BART Station Power. The annual energy requirements to power BART stations were derived from BART estimates based on data from existing stations. It is estimated that an above-ground station uses 85,000 kWh per month (290 million Btu)<sup>1</sup> and an underground station uses 145,000 kWh per month (490 million Btu).

The Irvington Station would be an underground station and the Warm Springs and South Warm Springs Stations would be above-ground. In order to determine the associated primary energy requirements, an energy generation/transmission efficiency factor for oil and gas generated electricity of 30 percent<sup>2</sup> was applied to estimate the total station energy requirements.

- Column 2: Maintenance Energy. Figures in column 2 represent estimated annual energy requirements to maintain BART vehicles. These calculations are based on estimates of 7,060 Btu/mile to maintain a rail transit vehicle.<sup>3</sup>
- Column 3: Traction Power. BART data indicates that the electrical propulsion energy used to power BART vehicles is approximately 4.9 kwh/mile (17,000 Btu). The primary energy inputs are estimated by multiplying this factor by the total increase in annual BART vehicle-miles projected under the operating plan for each alternative and then dividing by the 30 percent generation/transmission efficiency factor noted above.
- Column 4: Annual BART Power. Depicts the total annual primary energy requirements for BART stations, maintenance and traction power.

The peak hour electrical demands of the Proposed Project would include the power required to operate approximately 20 BART cars and power the three stations. All of the project alternatives would have the same or a smaller basic energy demand. California Energy Commission (CEC) projections for 1998, when the Proposed Project and BART alternatives is expected to begin operation, indicate that the PG&E system is expected to have a dependable capacity of 25.5 gigawatts with a 24.3 percent reserve margin.<sup>4</sup> The reserve margin considers both projected increases in demand throughout the service area (including new transportation,

---

<sup>1</sup> A Btu (British Thermal Unit) is the quantity of heat required to raise the temperature of one pound of water one degree Fahrenheit.

<sup>2</sup> Caltrans, op. cit. p. 42.

<sup>3</sup> *ibid.*, p. E-30.

<sup>4</sup> California Energy Commission, op. cit., p. B-6.

land and industrial developments) and new sources of supply, the largest of which are energy conservation and efficiency programs. Based on these CEC projections, it is concluded that the Proposed Project and BART alternatives would not result in a significant adverse effect on the region's projected energy supplies.

Table 3.15-2 represents estimates of indirect energy savings resulting from reduced auto use due to the Proposed Project and BART alternatives. The following energy savings are considered in the calculation:

- **Column 1: Energy Savings from Reduced Auto Use:** The figures in column 1 represent the energy savings from the indirect annual changes in auto use (vehicle miles travelled) that would exist in 1991 if the BART extension were in place and are predicted to occur in 1998 and 2010 with the BART extension. The data is drawn from the regional transportation model results for each of the alternatives. The large reductions in regional vehicle travel predicted with Alternatives 3 - 11 as compared to Alternatives 1 and 2, are the result of the aggregate benefits of all the regional transit improvements assumed with Alternative 3, but not with Alternatives 1 and 2. The effects attributable to the Proposed Project and BART alternatives are all relative to Alternative 3, which serves as the baseline for this analysis. It should be noted that increases in auto travel are projected with two of the single station alternatives (Alternatives 9 and 10). This anomaly is probably the result of other non-BART changes in the transportation network combined with the reduced BART patronage that would occur with a single-station extension.

The automobile energy calculations assume that a gallon of gasoline has an energy content of 140,000 Btu and that the average car will travel 20.3 miles per gallon in 1991, 21.8 miles per gallon in 1998 and 23.0 miles per gallon in 2010.<sup>1</sup>

- **Column 2: Auto Maintenance.** These figures represent the annual energy savings resulting from reduced auto manufacturing and maintenance. They are based on an estimate of 2,528 Btu/mile and include energy consumed in the production of oil and tires and in vehicle manufacturing, maintenance and repair.<sup>2</sup>

---

<sup>1</sup> Fuel consumption correction factors from: U.S. Dept. of Energy, *The Motor Fuel Consumption Model*, Dec. 1988.

<sup>2</sup> Caltrans, op. cit., p. C-36

Table 3.15-2

Net Annual Energy Consumption

|          | (1)<br>Energy Savings from<br>Reduced Auto Use |       | (2)<br>Energy Savings from<br>Reduced Auto Maintenance |       | (3)<br>Annual BART<br>Power Consumption | (4)<br>Net Annual<br>Energy Consumption |       |       |
|----------|------------------------------------------------|-------|--------------------------------------------------------|-------|-----------------------------------------|-----------------------------------------|-------|-------|
|          | 1991                                           | 2010  | 1991                                                   | 2010  |                                         | 1991                                    | 1998  | 2010  |
| Pro Proj | -25                                            | -24   | -27                                                    | -11   | 131                                     | 97                                      | 97    | 93    |
| Alt 1    | 5,000                                          | 4,900 | 5,400                                                  | 2,200 | --                                      | 6,800                                   | 6,800 | 7,600 |
| Alt 2    | 2,300                                          | 2,200 | 2,500                                                  | 1,000 | --                                      | 3,100                                   | 3,100 | 3,500 |
| Alt 3    | 0                                              | 0     | 0                                                      | 0     | --                                      | 0                                       | 0     | 0     |
| Alt 4    | -3.9                                           | -3.8  | -4.1                                                   | -1.7  | 88                                      | 83                                      | 83    | 82    |
| Alt 5    | -3.9                                           | -3.8  | -4.1                                                   | -1.7  | 88                                      | 83                                      | 83    | 82    |
| Alt 6    | -9.7                                           | -9.4  | -10                                                    | -4.3  | 111                                     | 98                                      | 98    | 97    |
| Alt 7    | -9.7                                           | -9.4  | -10                                                    | -4.3  | 111                                     | 98                                      | 98    | 97    |
| Alt 8    | -9.7                                           | -9.4  | -10                                                    | -4.3  | 111                                     | 98                                      | 98    | 97    |
| Alt 9    | 9.7                                            | 9.4   | 10                                                     | 4.3   | 100                                     | 110                                     | 110   | 110   |
| Alt 10   | 9.7                                            | 9.4   | 10                                                     | 4.3   | 100                                     | 110                                     | 110   | 110   |
| Alt 11   | -18                                            | -17   | -19                                                    | -7.8  | 111                                     | 87                                      | 87    | 84    |

Source: Donaldson Associates, 1991.

- Column 3: Annual BART Power Consumption. This is from Table 3.15-1.
- Column 4: Net Annual Energy Consumption. This is a summation of columns 1, 2, and 3 and represents the comparative net annual energy requirements for the operation and maintenance of each of the respective alternatives less any savings in reduced auto use that are predicted by the regional transportation model as a result of the Proposed Project and BART alternatives.

As can be seen in Table 3.15-2, none of the Proposed Project and BART alternatives are projected to result in a sufficiently large decline in regional VMT to have a net operational energy savings. Therefore, the operation of the project would involve an irreversible commitment of nonrenewable energy resources. This is considered a significant adverse effect.

However, by providing an alternative to the automobile for travel to destinations in southern Alameda County and for longer trips to regional centers including Oakland and San Francisco, the Proposed Project and BART alternatives would encourage the long term use of a more energy efficient transportation mode.

#### **Construction Impacts**

The construction of the Proposed Project or any of the Proposed Project and BART alternatives would result in the consumption of energy by construction equipment, for the transport of materials to the construction site, and the manufacture of material used in construction. Table 3.15-3 presents estimates of the energy requirements for the Proposed Project and BART alternatives based on the cost of construction. The range represents the lowest- and highest-priced design options for each alternative. Right-of-way costs are excluded. The estimate assumes an energy input of 12,500 Btu per dollar of construction cost.<sup>1</sup> The investment of energy from nonrenewable sources in the construction of the Proposed Project and BART alternatives would be an irreversible and significant impact.

#### **Cumulative Impacts**

Potential cumulative impacts could occur if the project, in combination with other projects, were to result in the requirements for additional power generating capacity. PG&E does expect

---

<sup>1</sup> Derived from 1967 estimates of 62,000 Btu per dollar of construction cost (Hannon, Stein, et. al., *Energy and Labor in the Construction Sector*, Science, Vol. 202, Nov. 1978.) updated and projected forward with Construction Price Index data to 1997.

**Table 3.15-3**  
**Construction Energy**  
**(Billions of Btu)**

|                  | Construction<br>Energy |
|------------------|------------------------|
| Proposed Project | 6,200 - 7,000          |
| Alternative 4    | 4,500 - 5,500          |
| Alternative 5    | 5,000 - 5,900          |
| Alternative 6    | 4,700 - 5,300          |
| Alternative 7    | 4,700 - 5,400          |
| Alternative 8    | 7,800 - 8,300          |
| Alternative 9    | 3,300 - 4,200          |
| Alternative 10   | 4,000 - 4,800          |
| Alternative 11   | 4,600 - 5,200          |

Source: Donaldson Associates, 1991.

that increasing demands within its service area will require the utility to increase its dependable capacity, however, the need is projected to be met primarily through conservation and energy efficiency programs. As noted above, these programs are expected to allow the utility to operate with a margin of reserve. Although the project would contribute to increases in the region's electrical demand, these demands have been anticipated and are included in the planning for commensurate increases in supply. No adverse cumulative effects on energy supplies are projected.

### 3.15.3 MITIGATION

The BART system incorporates a number of measures and programs to avoid or reduce inefficient, wasteful and unnecessary consumption of energy. Included are such features as regenerative braking, composite third rails and light vehicle weight.

Regenerative braking consists of using the vehicle traction motors to slow the train, which concurrently generates electricity that is used for on-board lighting and air conditioning or is delivered to the third rail to be picked up by another train in the vicinity that is accelerating. The composite third rails involve the use of both aluminum for its high conductivity and steel for its long-wearing service life. The composite rails are believed to provide over twice the conductivity of equivalent all-steel rails, thereby reducing potential transmission losses.

The BART cars are made with an aluminum skin and have aluminum wheels with steel tires. Although they can carry heavy passenger loads and operate at high speed, the cars are lighter than many "light-rail vehicles" being manufactured today. Because of the light vehicle weight, the difference in energy consumption between empty vehicles and vehicles loaded with passengers is significant.

The BART system has achieved important gains in energy efficiency through design modifications and changes in operating procedures. For example, the new design "C" cars make it much easier for BART to assemble smaller trains for off-peak service and reduce the amount of car switching and maneuvering in the storage yards. Another example includes the policy of storing cars in a "cold" or shut down mode when they are not in use. This has significantly reduced electrical consumption at the storage yards.

The BART operating personnel regularly review the system operations to identify ways to increase the systems energy efficiency while maintaining service and security standards. These efforts will continue whether or not the Proposed Project and BART alternatives is constructed.