

T R A N S I T C O O P E R A T I V E R E S E A R C H P R O G R A M

SPONSORED BY

The Federal Transit Administration

TCRP Report 23

Wheel/Rail Noise Control Manual

Transportation Research Board
National Research Council

TCRP OVERSIGHT AND PROJECT SELECTION COMMITTEE

CHAIR

MICHAEL S. TOWNES
Peninsula Transportation Dist. Comm.

MEMBERS

SHARON D. BANKS
AC Transit
LEE BARNES
Barwood, Inc.
GERALD L. BLAIR
Indiana County Transit Authority
SHIRLEY A. DeLIBERO
New Jersey Transit Corporation
ROD J. DIRIDON
IISTPS
SANDRA DRAGGOO
CATA
LOUIS J. GAMBACCINI
SEPTA
DELON HAMPTON
Delon Hampton & Associates
KATHARINE HUNTER-ZAWORSKI
Oregon State University
ALAN F. KIEPPER
Parsons Brinckerhoff, Inc.
PAUL LARROUSSE
Madison Metro Transit System
ROBERT G. LINGWOOD
BC Transit
GORDON J. LINTON
Federal Transit Administration
DON S. MONROE
Pierce Transit
PATRICIA S. NETTLESHIP
The Nettleship Group, Inc.
ROBERT E. PAASWELL
The City College of New York
JAMES P. REICHERT
Reichert Management Services
LAWRENCE G. REUTER
MTA New York City Transit
PAUL TOLIVER
King County DOT/Metro
LINDA WATSON
Corpus Christi RTA
FRANK J. WILSON
New Jersey DOT
EDWARD WYTKIND
AFL-CIO

EX OFFICIO MEMBERS

WILLIAM W. MILLAR
APTA
RODNEY E. SLATER
FHWA
FRANCIS B. FRANCOIS
AASHTO
ROBERT E. SKINNER, JR.
TRB

TDC EXECUTIVE DIRECTOR

FRANK J. CIHAK
APTA

SECRETARY

ROBERT J. REILLY
TRB

TRANSPORTATION RESEARCH BOARD EXECUTIVE COMMITTEE 1997

OFFICERS

Chair: David N. Wormley, *Dean of Engineering, Pennsylvania State University*
Vice Chair: Sharon D. Banks, *General Manager, AC Transit*
Executive Director: Robert E. Skinner, Jr., *Transportation Research Board*

MEMBERS

BRIAN J. L. BERRY, *Lloyd Viel Berkner Regental Professor, Bruton Center for Development Studies, University of Texas at Dallas*
LILLIAN C. BORRONE, *Director, Port Commerce, The Port Authority of New York and New Jersey (Past Chair, 1995)*
DAVID BURWELL, *President, Rails-to-Trails Conservancy, Washington, DC*
E. DEAN CARLSON, *Secretary, Kansas Department of Transportation*
JAMES N. DENN, *Commissioner, Minnesota Department of Transportation*
JOHN W. FISHER, *Joseph T. Stuart Professor of Civil Engineering, Director, ATLSS Engineering Research Center, Lehigh University*
DENNIS J. FITZGERALD, *Executive Director, Capital District Transportation Authority, Albany, NY*
DAVID R. GOODE, *Chair, President and CEO, Norfolk Southern Corporation*
DELON HAMPTON, *Chair and CEO, Delon Hampton & Associates*
LESTER A. HOEL, *Hamilton Professor, Civil Engineering, University of Virginia*
JAMES L. LAMMIE, *Director, Parsons Brinckerhoff, Inc., New York, NY*
BRADLEY L. MALLORY, *Secretary of Transportation, Pennsylvania Department of Transportation*
ROBERT E. MARTINEZ, *Secretary of Transportation, Commonwealth of Virginia*
JEFFREY J. McCAIG, *President and CED, Trimac Corporation, Calgary, Alberta, Canada*
MARSHALL W. MOORE, *Director, North Dakota Department of Transportation*
CRAIG E. PHILIP, *President, Ingram Barge Co., Nashville, TN*
ANDREA RINIKER, *Deputy Executive Director, Port of Seattle*
JOHN M. SAMUELS, *Vice President—Operating Assets, Consolidated Rail Corporation*
WAYNE SHACKELFORD, *Commissioner, Georgia Department of Transportation*
LESLIE STERMAN, *Executive Director, East-West Gateway Coordinating Council, St. Louis, MO*
JOSEPH M. SUSSMAN, JR. *East Professor, Civil and Environmental Engineering, MIT*
JAMES W. VAN LOBEN SELS, *Director, California Department of Transportation (Past Chair, 1996)*
MARTIN WACHS, *Director, University of California Transportation Center, Berkeley*
DAVID L. WINSTEAD, *Secretary, Maryland Department of Transportation*

EX OFFICIO MEMBERS

MIKE ACOTT, *President, National Asphalt Pavement Association*
ROY A. ALLEN, *Vice President, Research and Test Department, Association of American Railroads*
JOE N. BALLARD, *Chief of Engineers and Commander, U.S. Army Corps of Engineers*
ANDREW H. CARD, JR., *President and CEO, American Automobile Manufacturers Association*
THOMAS J. DONOHUE, *President and CEO, American Trucking Associations*
FRANCIS B. FRANCOIS, *Executive Director, American Association of State Highway and Transportation Officials*
DAVID GARDINER, *Administrator, U.S. Environmental Protection Agency*
JANE F. GARVEY, *Federal Highway Acting Administrator, U.S. Department of Transportation*
ALBERT J. HERBERGER, *Maritime Administrator, U.S. Department of Transportation*
T. R. LAKSHMANAN, *Director, Bureau of Transportation Statistics, U.S. Department of Transportation*
GORDON J. LINTON, *Federal Transit Administrator, U.S. Department of Transportation*
RICARDO MARTINEZ, *National Highway Traffic Safety Administrator, U.S. Department of Transportation*
WILLIAM W. MILLAR, *President, American Public Transit Association*
JOLENE M. MOLITORIS, *Federal Railroad Administrator, U.S. Department of Transportation*
DHARMENDRA K. (DAVE) SHARMA, *Research and Special Programs Administrator, U.S. Department of Transportation*
BARRY L. VALENTINE, *Acting Administrator, Federal Aviation Administration, U.S. DOT*

TRANSIT COOPERATIVE RESEARCH PROGRAM

Transportation Research Board Executive Committee Subcommittee for TCRP
DAVID N. WORMLEY, *Pennsylvania State University (Chair)*
SHARON D. BANKS, *AC Transit*
DENNIS J. FITZGERALD, *Capital Dist. Transportation Authority, Albany, NY*
LESTER A. HOEL, *University of Virginia*
GORDON J. LINTON, *U.S. Department of Transportation*
ROBERT E. SKINNER, JR., *Transportation Research Board*
JAMES W. VAN LOBEN SELS, *California Department of Transportation*

Report 23

Wheel/Rail Noise Control Manual

JAMES T. NELSON
Wilson, Ihrig & Associates, Inc.
Oakland, CA

Subject Area

Public Transit
Rail

Research Sponsored by the Federal Transit Administration in
Cooperation with the Transit Development Corporation

TRANSPORTATION RESEARCH BOARD
NATIONAL RESEARCH COUNCIL

NATIONAL ACADEMY PRESS
Washington, D.C. 1997

TRANSIT COOPERATIVE RESEARCH PROGRAM

The nation's growth and the need to meet mobility, environmental, and energy objectives place demands on public transit systems. Current systems, some of which are old and in need of upgrading, must expand service area, increase service frequency, and improve efficiency to serve these demands. Research is necessary to solve operating problems, to adapt appropriate new technologies from other industries, and to introduce innovations into the transit industry. The Transit Cooperative Research Program (TCRP) serves as one of the principal means by which the transit industry can develop innovative near-term solutions to meet demands placed on it.

The need for TCRP was originally identified in *TRB Special Report 213—Research for Public Transit: New Directions*, published in 1987 and based on a study sponsored by the Urban Mass Transportation Administration—now the Federal Transit Administration (FTA). A report by the American Public Transit Association (APTA), *Transportation 2000*, also recognized the need for local, problem-solving research. TCRP, modeled after the longstanding and successful National Cooperative Highway Research Program, undertakes research and other technical activities in response to the needs of transit service providers. The scope of TCRP includes a variety of transit research fields including planning, service configuration, equipment, facilities, operations, human resources, maintenance, policy, and administrative practices.

TCRP was established under FTA sponsorship in July 1992. Proposed by the U.S. Department of Transportation, TCRP was authorized as part of the Intermodal Surface Transportation Efficiency Act of 1991 (ISTEA). On May 13, 1992, a memorandum agreement outlining TCRP operating procedures was executed by the three cooperating organizations: FTA; the National Academy of Sciences, acting through the Transportation Research Board (TRB); and the Transit Development Corporation, Inc. (TDC), a nonprofit educational and research organization established by APTA. TDC is responsible for forming the independent governing board, designated as the TCRP Oversight and Project Selection (TOPS) Committee.

Research problem statements for TCRP are solicited periodically but may be submitted to TRB by anyone at any time. It is the responsibility of the TOPS Committee to formulate the research program by identifying the highest priority projects. As part of the evaluation, the TOPS Committee defines funding levels and expected products.

Once selected, each project is assigned to an expert panel, appointed by the Transportation Research Board. The panels prepare project statements (requests for proposals), select contractors, and provide technical guidance and counsel throughout the life of the project. The process for developing research problem statements and selecting research agencies has been used by TRB in managing cooperative research programs since 1962. As in other TRB activities, TCRP project panels serve voluntarily without compensation.

Because research cannot have the desired impact if products fail to reach the intended audience, special emphasis is placed on disseminating TCRP results to the intended end users of the research: transit agencies, service providers, and suppliers. TRB provides a series of research reports, syntheses of transit practice, and other supporting material developed by TCRP research. APTA will arrange for workshops, training aids, field visits, and other activities to ensure that results are implemented by urban and rural transit industry practitioners.

The TCRP provides a forum where transit agencies can cooperatively address common operational problems. The TCRP results support and complement other ongoing transit research and training programs.

TCRP REPORT 23

Project C-3 FY'93
ISSN 1073-4872
ISBN 0-309-06060-5
Library of Congress Catalog Card No. 97-60661

NOTICE

The project that is the subject of this report was a part of the Transit Cooperative Research Program conducted by the Transportation Research Board with the approval of the Governing Board of the National Research Council. Such approval reflects the Governing Board's judgment that the project concerned is appropriate with respect to both the purposes and resources of the National Research Council.

The members of the technical advisory panel selected to monitor this project and to review this report were chosen for recognized scholarly competence and with due consideration for the balance of disciplines appropriate to the project. The opinions and conclusions expressed or implied are those of the research agency that performed the research, and while they have been accepted as appropriate by the technical panel, they are not necessarily those of the Transportation Research Board, the National Research Council, the Transit Development Corporation, or the Federal Transit Administration of the U.S. Department of Transportation.

Each report is reviewed and accepted for publication by the technical panel according to procedures established and monitored by the Transportation Research Board Executive Committee and the Governing Board of the National Research Council.

Special Notice

The Transportation Research Board, the National Research Council, the Transit Development Corporation, and the Federal Transit Administration (sponsor of the Transit Cooperative Research Program) do not endorse products or manufacturers. Trade or manufacturers' names appear herein solely because they are considered essential to the clarity and completeness of the project reporting.

Published reports of the

TRANSIT COOPERATIVE RESEARCH PROGRAM

are available from:

Transportation Research Board
National Research Council
2101 Constitution Avenue, N.W.
Washington, D.C. 20418

and can be ordered through the Internet at
<http://www.nas.edu/trb/index.html>

FOREWORD

*By Staff
Transportation Research
Board*

This manual will be of interest to engineers responsible for wheel/rail noise control in the design, construction, and operation of rail transit systems. It provides practical step-by-step procedures for identifying wheel/rail noise control technologies with demonstrated effectiveness. Procedures are included for identifying wheel/rail noise sources, developing mitigation designs, and estimating probable costs and effectiveness. The manual covers noise generated on tangent track, curved track, and special trackwork. Mitigation measures include onboard, track, and wayside treatments. Accompanying the manual is a user-friendly software package that assists in identifying appropriate noise mitigation techniques for various types of wheel/rail noise. The user is presented with several screens to navigate a decision tree until a set of possible mitigation options is reached. Several sound “clips” are included to assist the user in determining the type of noise that most closely resembles that which is to be controlled. The software package also provides several calculation worksheets to estimate life-cycle costs and expected noise attenuation for various mitigation measures.

In today’s climate of environmental consciousness, transit systems are being called upon to reduce noise, which previously was considered an intrinsic part of their operations. Wheel/rail noise generated at either sharp radius curves or on tangent track is considered objectionable, and transit agencies have implemented numerous mitigation techniques of varying effectiveness to reduce or control this noise. Documenting the successes and failures of these mitigation practices is useful to transit agencies and designers.

Under TCRP Project C-3, research was undertaken by Wilson, Ihrig & Associates, Inc., to assess existing wheel/rail noise-mitigation techniques, classify and evaluate them, and provide the transit industry with tools to select the most appropriate proven solutions for wheel/rail noise problems. To achieve the project objectives, the researchers conducted a comprehensive literature review of wheel/rail noise control practices; surveyed all North American and selected foreign heavy and light rail transit agencies to ascertain their current wheel/rail noise-mitigation techniques and their related experiences—both good and bad; compiled wheel/rail noise mitigation field test reports from transit agencies, product manufacturers, and suppliers; and field tested noise mitigation measures at several transit agencies. Based on these activities, this *Wheel/Rail Noise Control Manual* and accompanying software tool were developed.

An unpublished companion report, prepared under this project and entitled *Wheel/Rail Noise Control for Rail Transit Operations—Final Report*, provides a summary of the various tasks undertaken during the project and includes results of wheel/rail mitigation techniques field tested during the project. Field tests conducted during the project were used to assess the effectiveness of dry-stick lubricants (high positive friction [HPF] dry-stick friction modifiers and low coefficient of friction [LCF] flange lubricants) in controlling rail corrugation and wayside noise at tangent track and wheel squeal at curves in Los Angeles and Sacramento; and the effectiveness of rail vibration dampers in controlling wheel squeal at curves in Boston. The results of these field tests have been incorporated in this *Wheel/Rail Noise Control Manual*. The companion document is available on request through the TCRP, 2101 Constitution Avenue, N.W., Washington, D.C. 20418.

CONTENTS

3	CHAPTER 1	Introduction
7	CHAPTER 2	Fundamentals of Acoustics
25	CHAPTER 3	Design Guidelines
35	CHAPTER 4	Wheel/Rail Noise Generation
67	CHAPTER 5	Selection of Noise Control Treatment
93	CHAPTER 6	Cost Analysis
105	CHAPTER 7	Onboard Treatments
143	CHAPTER 8	Trackwork Treatments
175	CHAPTER 9	Wayside Treatments
199	CHAPTER 10	Rail Corrugation Control

COOPERATIVE RESEARCH PROGRAMS STAFF

ROBERT J. REILLY, *Director, Cooperative Research Programs*
STEPHEN J. ANDRLE, *Manager, Transit Cooperative Research Program*
CHRISTOPHER W. JENKS, *Senior Program Officer*
EILEEN P. DELANEY, *Managing Editor*
KAMI CABRAL, *Production Editor*
HILARY FREER, *Assistant Editor*

PROJECT PANEL C-3

KAREN ARPINO, *MBTA, Boston, MA (Chair)*
HOMER CHEN, *WMATA, Washington, DC*
LOUIS COHN, *University of Louisville, KY*
WILLIAM JEHLE, *MTA New York City Transit*
JERRY E. McCLEERY, *BART, Oakland, CA*
WALTER "BUD" MOORE, *LACMTA, Los Angeles, CA*
KHAJA FASIHUDDIN, *MTA New York City Transit*
WALTER KEEVIL, *Chicago Transit Authority*
VENKAT PINDIPROLU, *FTA Liaison Representative*
JON WILLIAMS, *TRB Liaison Representative*

ACKNOWLEDGMENTS

The research was performed under TCRP Projects C-3 by Wilson, Ihrig & Associates, Inc., as prime contractor, with support by Zeta-Tech, Inc., W.S. Atkins, Ltd., Acentech, Inc., and BBN Systems and Technologies, Inc., as subcontractors. The contract was monitored by Mr. Christopher Jenks of the Transportation Research Board.

Dr. James T. Nelson, Vice President of Wilson, Ihrig & Associates, Inc., served as Principal Investigator and Dr. George Paul Wilson, President of Wilson, Ihrig & Associates, Inc., served as Project Director. Dr. Allan Zaremski, President of Zeta-Tech, Inc., provided a detailed review of the literature, and contributed to the Manual with respect to rail lubrication, corrugation control, and grinding practices. Mr. David Coate of Acentech, Inc., provided material concerning sound barrier wall performance, and provided copies of technical reports prepared by Bolt Beranek and Newman Inc., for the U.S. Department of Transportation. Dr. Paul J. Remington of BBN Systems and Technologies, Inc., provided a detailed technical report summarizing wheel/rail rolling noise theory and recent advances thereof with respect to high speed rail. Dr. David Malam of W.S. Atkins, Ltd., in the United Kingdom provided a summary of foreign

literature and experience, and conducted a survey of several systems in the United Kingdom. Mr. Pablo A. Daroux of Wilson, Ihrig & Associates, Inc., designed and developed the software package for supporting the Wheel/Rail Noise Control Manual, including digitizing numerous audio samples of wheel/rail noise. Mr. Derek Watry, of Wilson, Ihrig & Associates, Inc., provided a model for economic analysis of noise control provisions. Mr. Frank Iacovino of Acentech, Inc., provided technical support in the measurement of wheel squeal noise reduction effectiveness of rail vibration dampers at the MBTA, for which Phoenix, USA, provided rail vibration dampers and hardware for testing. Valuable comments and suggestions were provided by members of various transit agencies and by the TCRP project C-3 Panel. The MBTA, Sacramento RTD, and LACMTA provided access to facilities for testing and evaluation. Finally, many substantial advances in wheel/rail noise control were made during the late 1970s and early 1980s under Federal programs administered by the Transportation Systems Center, now the Volpe Transportation Center in Cambridge, MA. Under this program, many individuals contributed valuable expertise and analysis which greatly benefited the current study.

CHAPTER 1 INTRODUCTION

- 1.1 Introduction, 3
- 1.2 Purpose, 3
- 1.3 Scope, 3
- 1.4 Manual Organization, 3
- 1.5 Annotated Bibliography, 4
- 1.6 Software Support, 4
- 1.7 Wheel/Rail Noise Control Software, 4
- 1.8 References, 5

This page left intentionally blank.

CHAPTER 1

INTRODUCTION

1.1 INTRODUCTION

This manual identifies mitigation procedures for wheel/rail noise produced by rail transit systems. The material incorporated herein is based on an extensive review of the literature and survey of rail transit systems.

The intended audience of this Manual includes transit system engineers responsible for design, construction, and operation of rail transit systems. The user of this Manual assumes all risks and responsibilities for selection, design, construction, and implementation of mitigation measures. No warranties are provided to the user, either expressed or implied. The data and discussions presented herein are for information only.

1.2 PURPOSE

This Manual provides the user with practical step-by-step procedures for controlling wheel/rail noise, based on proven technologies with demonstrated effectiveness. Procedures are included for identifying wheel/rail noise sources, developing mitigation designs, and estimating probable costs.

1.3 SCOPE

The scope of the Manual is wheel/rail noise generated by the interaction of wheel and rail, and radiated by the wheel and rail to the vehicle interior and wayside. Structure radiated and groundborne noise are not specifically included, though noise from aerial or steel elevated structures is discussed primarily from the standpoint of trackwork design. Groundborne noise is not considered, even though its genesis involves wheel/rail interaction. Groundborne noise and vibration is discussed in the *Handbook of Urban Rail Noise and Vibration Control (1)* and in the *State-of-the-Art Review: Prediction and Control of Groundborne Noise and Vibration from Rail Transit Trains (2)*.

1.4 MANUAL ORGANIZATION

Chapter 2 summarizes the fundamentals of acoustics that apply to wheel/rail noise control. The reader's background is

assumed to be that of a mechanical or civil engineer who is capable of understanding and applying concepts in dynamics, mechanical vibration, and acoustics. Concepts and nomenclature familiar to the noise control engineer working in transit noise control and transportation noise impact analysis are presented and discussed. The reader is referred to the literature for detailed discussions.

Guidelines and goals for wayside and interior noise levels are discussed in Chapter 3, drawing heavily on the American Public Transit Association (APTA) *Guidelines for Rail Transit System Design (3)*, and on the Federal Transit Administration (FTA) *Transit Noise and Vibration Impact Assessment (4)*.

Chapter 4 discusses the theory of wheel/rail noise generation, including the most recent models of rolling noise that have been proposed or investigated with respect to high-speed rail as well as conventional transit. Wheel squeal noise generation is discussed separately of rolling noise, as the processes are dissimilar, involving noise generation at curved track. The principal purpose of this chapter is to provide the reader a basis for identifying types of noise and the potential effectiveness of various noise mitigation procedures. The wheel/rail noise generating mechanisms are several in number; they include random rail and wheel roughness, rail corrugation, stick-slip generated squeal and howl, and impact noise. Identification of the nature of the type of noise is critical in identifying appropriate noise control measures. Included are discussions of normal or optimally low noise levels for vehicles and equipment in good running condition.

Chapter 5 is perhaps the principal chapter of the Manual, where the user is led through a step-by-step process of identifying appropriate noise mitigation provisions. The Manual stops short of recommending a specific treatment, providing only noise reduction estimates and probable costs. Treatments are categorized in terms of tangent track, curved track, and special trackwork. The treatments are further categorized for onboard, trackwork, and wayside application. This chapter is supported by a computer program that provides aural examples of various types of noise, algorithms of computing noise reductions, and a cost model.

Chapter 6 provides a methodology for assessing the costs of various mitigation options. Cost comparisons are made on the basis of the annuity cost, taking into account the present

value, and discounted future fixed and periodic costs. The methods of this chapter are supported by the accompanying software package.

Chapters 7, 8, and 9 present detailed discussions of various treatment designs for onboard, trackwork, and wayside application, respectively. The chapter concerning onboard treatments includes material on vehicle interior noise control, and the chapter on wayside application includes sections on subway station and vent and fan shaft noise control.

Chapter 10 discusses rail corrugation and possible methods for control. Rail corrugation is perhaps the most significant cause of community reaction and complaints concerning rolling noise, due to the particularly raucous nature and high level of the sound. No discussion of wheel/rail noise control would be complete without including rail corrugation generation and control. The discussion provided here is intended to acquaint the user with certain theoretical aspects and observations concerning rail corrugation, together with possible methods for control, of which the only reliable treatment identified thus far is aggressive rail grinding. However, this chapter does not provide solutions to the rail corrugation problem.

Each chapter contains its own table of contents and reference list, so that each chapter is reasonably self-contained.

1.5 ANNOTATED BIBLIOGRAPHY

The Manual is supported by an annotated bibliography assembled as part of the literature review. The annotated bibliography attempts to include all references to published documents, and is implemented in a bibliographic software package for updating and generation of key word lists.

1.6 SOFTWARE SUPPORT

A software package is provided with the Manual. The software was developed with Microsoft, Inc.'s Visual Basic as an application under Microsoft, Inc.'s Windows® 3.1 operating system. The software should run properly on Microsoft, Inc.'s Windows 95 operating system.

The elements of the software package include the following:

- Audio samples of wheel/rail noise, including rolling noise, corrugated rail noise, wheel flat noise, and wheel squeal.
- A decision tree to help the user select noise control treatments.
- A cost analysis algorithm to estimate the annuity cost of a treatment, given fixed and periodic costs.
- Noise reduction routine for sound barriers.
- A “help” facility which provides references to the Manual, including text imported from the Manual.

The software package is intended to be user-friendly, providing the user a means of rapidly identifying appropriate mit-

igation techniques. However, the user should refer to the Manual for detailed discussion of each noise control treatment. Further, manufacturers' costs, specifications, and performance data should be reviewed carefully prior to selection.

1.7 WHEEL/RAIL NOISE CONTROL SOFTWARE

The purpose of this software package is to aid the user in determining the cause of abnormal noise levels in the transit system and identify mitigation options. The user is presented with several screens to navigate a decision tree until a set of possible mitigation options are reached. Several “sound clips” and two “sound demo” screens are available to help the user determine the type of noise that most closely resembles that which is to be controlled.

The software package contains three Calculation Worksheets, i.e., spreadsheet-like screens to

1. Estimate the expected attenuation of rail transit vehicle noise by sound barrier walls,
2. Predict L_{dn} and CNEL levels at any nearby receiver due to a typical light rail train, and
3. Calculate the Equivalent Uniform Annual Cost of mitigation options so that the true cost of mitigation alternatives over their lifetime can be compared.

The software has a comprehensive set of “help screens” which can be activated at any time by pressing the Windows® help key (F1). The help screens provide mostly operational information to assist the user in the basics of the software. The user can also search the help system for key words by selecting the “Help” menu option on top of the screen and then “Search for help on...”

In addition, the text and tables of most of the Wheel/Rail Noise Control Manual have been incorporated in the help file provided with the software. The text has been enriched by the use of hypertext “links,” shown as underlined words in green, which can be “clicked” to obtain definitions of technical terms from the Glossary or used to navigate to other related topics. The help window also contains a series of buttons on its top row which allow immediate access to the Glossary of terms or the Contents page, and navigation through a Chapter of the Manual (“<<” and “>>” browsing keys).

System Requirements

The following are system requirements:

1. 386 or better Processor (486-33 or better recommended)
2. Microsoft Windows® 3.1 or higher
3. VGA video or better (640×480 pixel resolution minimum). The screens have been optimized for the

“lowest common denominator” resolution of 640×480, and that is, therefore, the recommended resolution to which Windows should be set. Please see your system administrator to adjust your screen to this resolution.

4. 5.5 Megabytes of free hard disk space.
5. 4 Megabytes of RAM memory (8 recommended).

In addition, the following is recommended:

6. Windows compatible sound system card and loudspeakers (only necessary to play back sound clips).

Installation

Insert disk #1 in the 3¹/₂" diskette drive of your computer. From the Windows File Manager screen select:

File | **R**un

then type:

A:SETUP <enter> (type B:SETUP if your 3¹/₂" drive is B:)

The software will be installed by default in the directory “C:\TCRPC3”. However, the setup program will allow installation in any other directory or drive.

Follow the instructions on the screen to swap diskettes when needed.

The setup program will create a new program group and insert the program icon for the software (a picture of a wheel on a rail emanating sound waves).

To run the software, double-click on the icon.

Operation

Once the software is run by double-clicking on the icon, the user will be presented with a Copyright banner screen which will remain on for about 5 sec. After that, the main screen will appear and the user will be asked to select one of the three noise classes: Tangent Track noise, Curved Track noise, and noise associated with Special Trackwork such as frogs. Most of the screens have an “information line” at the bottom providing further information about the current screen or option.

By single-clicking on one of the rectangular buttons on the screen current at the time, the user will move further down the decision tree until a final screen displaying the section of text of Chapter 5 of the Wheel/Rail Noise Control Manual pertinent to the noise mitigation option selected by the user

is displayed. If there is a sample calculation screen for that particular mitigation option, a button will appear which, when “clicked” will display the appropriate worksheet.

Also, if the user selects Sound Barriers, Absorptive Sound Barriers or Earth Berms as mitigation options, another button will become available which leads to a Sound Barrier Insertion Loss worksheet. The computations there conform to the design guidelines for sound barrier attenuation described in the *Handbook of Urban Rail Noise and Vibration Control (1)*.

To go back up the decision tree, the user can single-click the left pointing arrow at the bottom left of each screen or press the “Escape” key, usually located at the top-left corner of most keyboards.

To start again at the top of the decision tree, select the menu option **F**ile | **S**tart Again.

To adjust the playback volume of the sound clips, use the utility program provided with your sound board. This is usually a “mixer” utility that adjusts the playback level of Windows programs.

To **END** the run, select **F**ile | **E**xit from the menu bar at the upper left corner of the screen.

For questions or difficulties installing the software, call Pablo Daroux at (510) 658–6719 between the hours of 9 a.m. and 5 p.m. PST.

The software is a Microsoft Windows® application; therefore a personal computer running Windows 3.1 or Windows 95 is required. The code was written by Pablo Daroux at Wilson, Ihrig & Associates using Microsoft Visual Basic version 4.0 on a 486–66 personal computer. It has been tested in machines running Windows 3.1, 3.11, Windows for Workgroups 3.11, and NT Workstation Version 3.51. CPUs tested under include 486DX2/50, 486DX2/66, Pentium 90 and Pentium Pro 200 series with no compatibility problems.

1.8 REFERENCES

1. Saurenman, H.J., J.T. Nelson, and G.P. Wilson, *Handbook of Urban Rail Noise and Vibration Control*, Wilson, Ihrig & Associates, Inc. for U.S.DOT, UMTA, DOT-TSC-UMTA–81–72, NTIS No. UMTA-MA–06–0099–82–1 (February 1982).
2. Nelson, J.T. and H.J. Saurenman, *State-of-the-Art Review: Prediction and Control of Groundborne Noise and Vibration from Rail Transit Trains*, Wilson, & Associates, Inc. for U.S.DOT, UMTA, NTIS No. UMTA-MA–06–0049–83–4 (December 1983).
3. *1981 Guidelines for Design of Rapid Transit Facilities*, Rail Transit Committee, APTA, Transit Development Corporation, Inc. (June 1981).
4. *Transit Noise and Vibration Impact Assessment*, Final Report, Harris, Miller, Miller & Hanson, Inc. for Office of Planning, FTA U.S.DOT, DOT-T–95–16 (April 1995).

CHAPTER 2 FUNDAMENTALS OF ACOUSTICS

- 2.1 Introduction, 7
- 2.2 Physics of Sound, 7
 - 2.2.1 Amplitude and Spectra, 7
 - 2.2.2 Geometric Spreading, 8
 - 2.2.3 Atmospheric Absorption, 8
 - 2.2.4 Diffraction Due to Barriers, 8
 - 2.2.5 Sound Absorption, 9
 - 2.2.6 Wind and Temperature Gradients, 9
- 2.3 Parameters Used to Characterize Sound, 9
 - 2.3.1 Sinusoidal Waves, 9
 - 2.3.2 Superposition of Two Sinusoidal Waves, 11
 - 2.3.3 Random Noise, 11
 - 2.3.4 Decibel Levels, 13
 - 2.3.5 Weighted Sound Levels, 13
 - 2.3.6 Frequency Analysis, 15
 - 2.3.6.1 Octave and 1/3 Octave Analyses, 15
 - 2.3.6.2 Constant Bandwidth Analyses, 17
 - 2.3.6.3 Spectrum Level and Power Spectral Density, 18
- 2.4 Characterizing Noise Environments, 18
 - 2.4.1 Noise Criterion Curves, 18
 - 2.4.2 Energy Equivalent Levels, 20
 - 2.4.3 Histograms, 20
- 2.5 Sound Absorption and Transmission, 20
 - 2.5.1 Sound Transmission Loss, 22
 - 2.5.2 Sabine Absorption Coefficient, 22
 - 2.5.3 Noise Reduction Coefficient–NRC, 22
 - 2.5.4 Sound Transmission Class–STC, 22
 - 2.5.5 Materials and Mounting, 22
- 2.6 References, 22

CHAPTER 2

FUNDAMENTALS OF ACOUSTICS

2.1 INTRODUCTION

This chapter discusses certain fundamental aspects of acoustics and noise to acquaint the user with basic concepts and terminology that may be otherwise unfamiliar. The fundamentals are covered in both technical and descriptive terms. The following topics are covered:

- Physics of sound,
- Parameters that are used to measure and characterize acoustic wave phenomena,
- Descriptors that are used to characterize environmental noise exposure, and
- The basic theory of sound absorption and sound isolation.

A number of reference books are available that provide an introduction to the field for the nontechnically oriented reader, along with more detailed information for engineers. In addition to the references cited throughout this manual, the following are recommended:

- The *Handbook of Noise Control (1)*: This is a general reference on noise control. The Handbook contains 45 chapters on different aspects of noise control, each written by a different author. Most of the material is technical but does not require an acoustics background to be understood.
- Beranek, *Noise and Vibration Control (2)*: This widely used text provides substantial detail and is sufficiently mathematically oriented to allow evaluation of parametric effects. Although a valuable source for acoustical engineers, it is probably not appropriate for those who do not have backgrounds in engineering or physics.
- Rettinger, *Acoustic Design and Noise Control (3)*: This book (Volume 1, Acoustic Design and Volume 2, Noise Control) presents a wealth of practical information on the design of noise control features.
- Kinsler and Frey, *Fundamentals of Acoustics (4)*: This widely used text is standard for undergraduate acoustics courses and is, therefore, readily available. The text provides a thorough discussion of the theory of acoustics and environmental noise, though the material tends to be very theoretical for direct application to noise control problems.

- “Transportation Noise and Its Control” (5): This pamphlet, prepared by the U.S.DOT, describes transportation noise (aircraft, highway, and rapid transit) to the general public. It also includes a general description of the physics of sound.
- Lutz, *Theory and Practical Application of Noise and Vibration Abatement for Railway Vehicles (6)*: This monograph focuses on noise abatement procedures that can be applied to diesel locomotives, but most of the information is sufficiently general to also be applied to transit system noise control.
- *Handbook of Urban Rail Noise and Vibration Control (7)*: This document, prepared for the Urban Mass Transit Administration (UMTA), provides detailed design guidelines for both noise and vibration produced by urban rail transit systems.

This list of references is meant to be representative and is by no means exhaustive.

2.2 PHYSICS OF SOUND

Sound is a fluctuating disturbance of the air (or other gas) caused by propagating pressure waves. Sound travels through air in the form of small waves similar to the way circular waves created by a tossed stone spread on the surface of a pond. The most common source of disturbance is a vibrating object, such as a tuning fork. The vibrating object disturbs the air molecules by alternately causing compression (squeezing together) and rarefaction (pulling apart) of the air molecules. The compression and rarefaction result in a pressure wave that travels (propagates) away from the vibrating object at a constant speed. As for waves on the surface of a quiet pond, there is no net transfer of matter by the wave when averaged over time.

2.2.1 Amplitude and Spectra

Sound is characterized by the amplitude and the frequency of the pressure fluctuations. Typically, sound will contain many different frequency components, and together form the spectrum of the sound. There are some sounds that consist of only one frequency; the sound produced by a tuning fork is

an example of a single discrete frequency sound. The sound of a train passby consists of a wide frequency spectrum which is smooth, without discrete frequency components.

The speed of sound in air is independent of frequency and varies only slightly with humidity and atmospheric pressure. At a temperature of 20° C (68° F) the speed of sound is approximately 344 m/sec (1127 ft/sec). The air temperature can have a significant effect on the speed of sound; the speed of sound increases about 0.61 m/sec for each 1° C increase in temperature.

2.2.2 Geometric Spreading

By considering a stone thrown into a pond and the resulting circular surface wave, several salient features of noise generation and noise control can be visualized. However, the pond wave is a *surface wave* radiating in two dimensions whereas sound is a *body wave* radiating in three dimensions. Consider first the size of the stone thrown into the pond. Clearly, the larger the stone, the larger the resulting wave will be. In a noise scenario, the “size of the stone” corresponds to the amplitude of the vibrating object which, in turn, determines the amplitude of the pressure wave. The pressure wave amplitude is related to the perceived *loudness* of the sound. Hence, the loudness of unwanted noise can be reduced by limiting (damping) the vibration amplitude of the object creating the sound, i.e., by throwing a smaller stone. “Large stones” in rail transit include things such as jointed rails, wheel flats, and rough rails.

Imagine for the moment that the stone hits the water in the middle of a very large pond (so that the wave can travel a long way before it encounters the shore). As the circular wave propagates outward, the amplitude decreases for two reasons, both of which involve the amount of *energy* in the wave.

Every wave contains a certain amount of energy which is distributed throughout the wave. Using the water wave analogue, the energy per unit surface area of the wave is called the *energy density*, and the energy density is related to the amplitude of the wave. The energy consists of roughly equal parts of kinetic and potential energy when averaged over a cycle in time, or period. As the circular wavefront in the pond becomes larger, the energy is spread out over a greater area, or volume, and, hence, the amplitude of the wave decreases. This is called *geometric attenuation*. With geometric attenuation, the energy of the wave is spread over an increasingly large area as the wave propagates away from the source, but the total amount of energy in the wave remains constant in the absence of absorption or damping. If geometric attenuation were the only mechanism by which the wave amplitude decreased, the wavefront would eventually reach the shore, although its height might be very small by the time it got there.

2.2.3 Atmospheric Absorption

Friction is another mechanism which decreases the wave amplitude by actually decreasing the amount of energy in the

wave. The internal friction of a fluid is measured by its *viscosity*. Most people think of honey or oil when they hear the word viscosity because these are common examples of viscous (i.e., high internal friction) fluids. However, water and air also have viscosities. In other words, they have internal friction. When a wave passes through a fluid, the internal friction of that fluid converts some of the mechanical wave energy to heat energy. This reduction in wave energy can be significant. Returning to the analogy of a circular wave on a pond, the absorption of high-frequency components will cause an initially “rough” wave to become smooth as it spreads. Ultimately, the viscosity of the pond water could prevent the wavefront from reaching the shore by dissipating all of the wave energy before it arrived.

To review the previously discussed attenuation mechanisms, consider them in the context of rail transit passby noise. As the train passes, acoustic waves which compose the passby noise propagate away from the train. As they spread, the energy contained within them is distributed over a large area, which might be visualized as an imaginary cylinder with its center along the track. The spreading reduces the energy density of the noise, manifested as a decrease in loudness. At the same time, some of the acoustic wave energy is being converted into heat energy by the viscosity of the air, especially at the higher frequencies. This will further decrease the loudness of the noise and, more noticeably, will alter the character of the passby noise, similar to turning down the treble adjustment on a car radio. Although both of these mechanisms are effective in reducing the amplitude (loudness) of a propagating acoustic wave, the distance required to attenuate train passby noise to an acceptable level is often much further than the distance to the nearest affected receptor. Therefore, other means of controlling train noise may be necessary.

2.2.4 Diffraction Due to Barriers

Harbors and marinas often have walls or piles of boulders placed at their entrances to protect them from the undulating force of incoming waves. Likewise, sound barrier walls are often used to reduce loudness in the space behind them by reflecting sound waves which impinge upon them (assuming they are sufficiently massive). Walls are not, however, completely effective at blocking acoustic pressure waves because of a phenomena called *diffraction*.

As everyone who routinely calls out to people in adjacent rooms knows, sound waves can travel around corners, up stairs, and down hallways, because acoustic pressure waves can be both reflected and diffracted. Diffraction is the process by which the direction of a sound wave “bends” around a corner or over the top of a wall. Surface waves on a pond diffract around the hulls of ships or breakwaters. Diffraction is frequency dependent; low-frequency waves bend around corners much more readily than high-frequency waves. As with the energy absorption mechanism introduced above, this changes the character of broadband noise which

is diffracted by disproportionately reducing the high-frequency components of the sound, or “treble.”

2.2.5 Sound Absorption

Sound barrier walls made of concrete or brick reflect practically all of the energy contained in the acoustic waves which strike them directly. However, these reflected waves may still find their way over the wall by being subsequently reflected off the train car and then diffracted. To prevent this, absorptive material may be fixed to the surface of the wall. The absorbing mechanism is due to friction between moving air and the loose fibers or pore walls in the sound absorbing treatment. The friction between the air and porous or fibrous absorptive material converts the acoustic energy to heat, thereby attenuating the sound.

2.2.6 Wind and Temperature Gradients

When sound propagation outdoors is considered, there are the additional complications of refraction caused by wind or thermal gradients and excess attenuation caused by rain, fog, snow, and atmospheric absorption. (Refraction is the phenomenon by which the direction of propagation of a sound wave is changed due to spatial variation in the speed of sound.) These environmental effects on sound propagation are discussed briefly below.

Figure 2–1 illustrates the effect of wind on sound propagation. Typically, the wind speed increases with elevation above the ground. The result is that when sound is propagating upwind, its path is refracted (bent) upwards, and when it is propagating downwind, its path is bent downwards. The amount of refraction will depend on the rate of wind speed change with altitude. Propagation of sound in wind can result in upwind shadowing and downwind reinforcement that can cause large deviations from the expected geometric attenuation of sound.

Temperature gradients will cause refractions in a manner similar to wind gradients. Under normal atmospheric conditions, a clear afternoon with air temperature decreasing with increasing altitude, the sound waves will be refracted upwards. However, when the air temperature increases with elevation, the sound is refracted downwards. This condition is called an *inversion* and may occur just after dusk, persisting throughout the night and into the following morning. Under such conditions, strong noise level enhancements can occur. The effect of a temperature inversion layer is shown in Figure 2–1.

Although it is commonly said that sound carries well on days of fog or light precipitation, the evidence indicates that this is due to a lack of strong thermal and wind gradients during precipitation. Another factor contributing to the apparent ability of sound to carry well during light precipitation is lower levels of background noise at these times because of the normal reduction of outdoor activities.

Finally, although there is no evidence that lightly falling snow has a significant effect on the propagation of sound through air, in some cases snow on the ground will increase the attenuation of sound by acting as a sound absorption treatment, producing a so-called “ground effect.” Ground effects may also be produced by grass-covered surfaces or other soft ground cover, and are usually considered in noise predictions for relatively large distances. For typical rail transit noise, ground effects are not normally considered, because of the relatively narrow noise impact corridors associated with rail transit noise. However, this is not a rule, as certain situations may dictate that ground effects be considered, especially where noise reductions at large distances from the track are considered. In such cases, introduction of a sound barrier wall may effectively elevate the source height, thus reducing the ground effect and circumventing, perhaps partially, the noise reduction effectiveness of the wall.

2.3 PARAMETERS USED TO CHARACTERIZE SOUND

In this section, some basic mathematical aspects of sound waves are described to explain how sound can be measured and analyzed with scientific instruments to yield meaningful design data. Initially, the simplest type of waveform, the sinusoidal wave, is considered. An understanding of this simple wave form is of fundamental importance because even the most complex waveforms encountered in the real world can be thought of, and analyzed, as being composed of a large number of these simple waves.

2.3.1 Sinusoidal Waves

Figure 2–2 illustrates the instantaneous amplitude as a function of time of a sinusoidal wave (sine wave), a wave or motion consisting of a single frequency. A single-frequency sound wave is generally referred to as a “pure tone.” Figure 2–2 could be a plot of

- The displacement of a freely vibrating simple harmonic oscillator. The classic example of a simple harmonic oscillator is a mass supported on an undamped spring.
- The displacement of a pendulum oscillating at a small amplitude about the equilibrium point.
- The pressure fluctuation caused by a pure tone sound wave such as that created by a tuning fork.
- Wheel squeal produced at curves

The oscillatory motion of the wave in Figure 2–2 is completely described by the frequency f , the amplitude, A , and the initial phase angle. In mathematical terms, the amplitude, $p(t)$ is given by

$$p(t) = A \cos(2\pi f t + \phi)$$

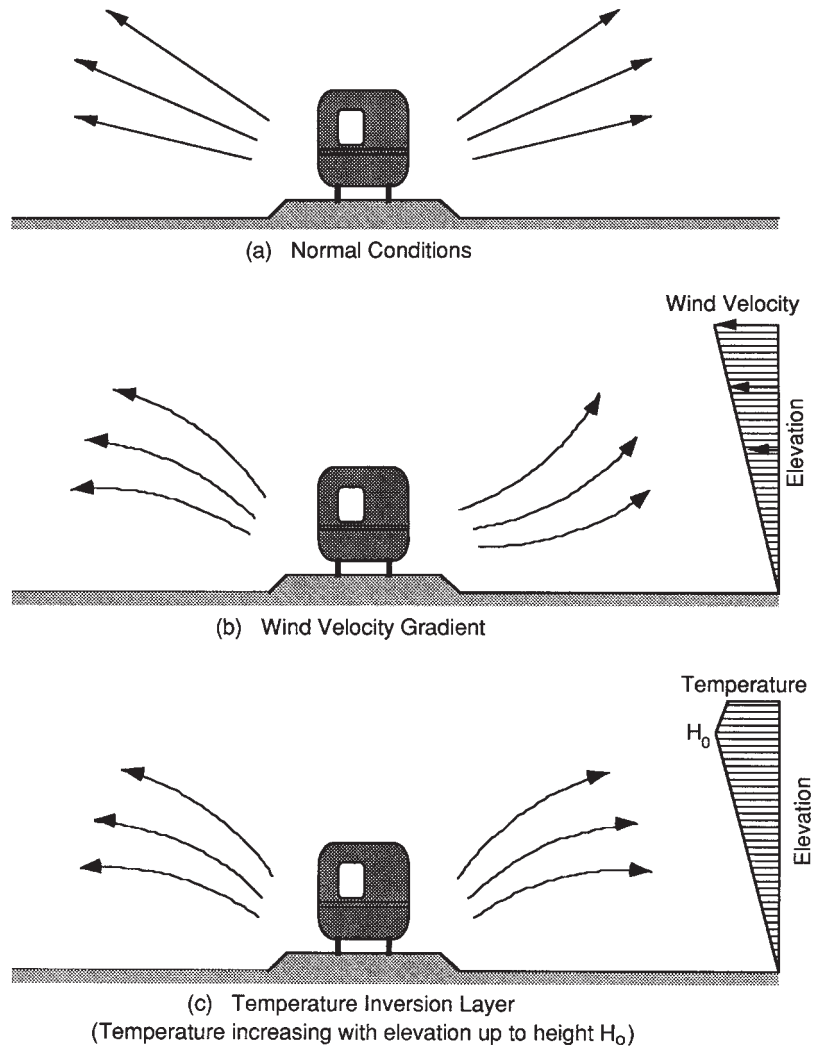

FIGURE 2-1 ATMOSPHERIC EFFECTS ON SOUND PROPAGATION

The frequency is the number of cycles of the motion that occur in 1 sec and, for sound waves, is related to its pitch. Frequency is denoted in Hertz (Hz), where one Hertz is defined as one cycle per second.

Widely used descriptors of simple, oscillatory waves are:

$$\text{Period (for one cycle)} = T = 1/f$$

$$\text{Peak-to-peak amplitude} = 2A$$

$$\text{Root-mean-square amplitude} =$$

$$p_{\text{rms}} = \sqrt{\frac{1}{T} \int_0^T p^2(t) dt}$$

The integration time, T , is an important parameter, often defined as 1 sec (“slow meter response”), or 0.1 sec (“fast meter response”). The slow- and fast-meter responses, or rms detector time constants, are employed in sound level meters to determine the rms sound level as a function of time. How-

ever, the time, T , can be set to any length, such as an hour, day, year, or simply the period, $1/f$, of the wave. The discussion of any rms amplitude should include a specification of the “integration time,” or sound-level meter response characteristic, used to arrive at the amplitude.

In the limit as T approaches infinity, the rms amplitude of a sinusoidal sound pressure wave of amplitude, A , is:

$$p_{\text{rms}} = A/\sqrt{2} = 0.707A$$

Thus, the *mean-square pressure*, $\langle p^2 \rangle$, is simply $1/2$ the square of the amplitude, A^2 .

Fortunately, the condition that T approach infinity for the calculation of the root-mean-square amplitude and the rectified average can be approximated by a relatively short sample time. As a worst case example, the rms amplitude of a 20 Hz sine wave is within one percent of its theoretical limit after 0.2 sec. The rms amplitudes of higher frequency waves converge even faster. Thus, sound level meters

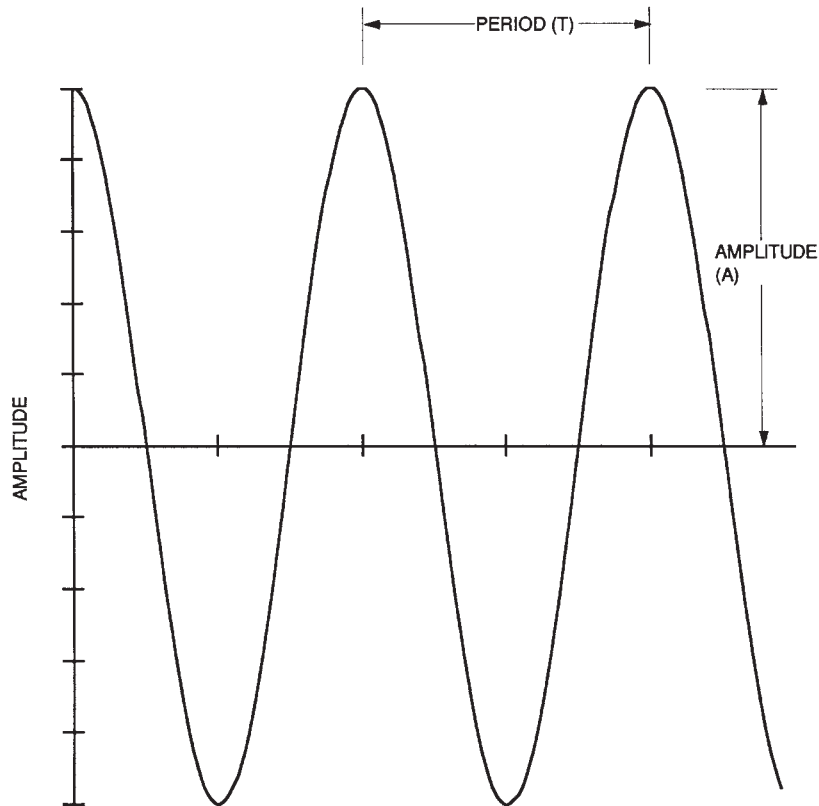

FIGURE 2-2 SINGLE FREQUENCY WAVEFORM

typically use averaging times on the order of 0.1 sec or 1 sec, corresponding to the fast- and slow-meter responses, respectively.

2.3.2 Superposition of Two Sinusoidal Waves

The next level of complexity in wave analysis is the summation of two sinusoidal waves, as illustrated in Figure 2-3. For the special case where two waves have the same frequency, the result will be a third wave oscillating at the given frequency with an amplitude and phase angle dependent on the amplitudes and phase angles of the constituent waves. If the amplitudes are similar and the phase angles are close, there will be constructive interference and the resulting amplitude will be approximately double that of the constituents. On the other hand, if the phase angles are roughly 180 degrees apart, there will be destructive interference and the resulting amplitude will be small. In any case, the rms amplitude is determined in the same manner as described above for a sine wave.

When the frequencies of the two waves are different, the rms value of the combined signal is given by the formula

$$P_{\text{rms}} = \sqrt{P_{1\text{rms}}^2 + P_{2\text{rms}}^2}$$

Theoretically, the above formula is exact only as the integration time period considered approaches infinity. However,

the rms amplitude of the combined signal is within 1% of this limit for averaging time greater than $50/\Delta f$, with the absolute difference of the two frequencies, Δf , given in Hertz. This is the time necessary to account for the effect of alternating constructive and destructive interference which occurs as the relative phase between the two waves slowly varies. As an example, if two noise sources differ in frequency by 1 Hz, such as fans running at 120 Hz and 121 Hz, approximately 1 min of the resulting sound would need to be analyzed before the rms converged to the above limit. If the fans were operating at 120 Hz and 180 Hz, less than 1 sec would be required. These results are primarily relevant to the combination of sound sources with strong tonal components such as fans and other machinery.

2.3.3 Random Noise

Most noise is comprised not simply of several tonal components, but very complex waveforms which have continuous frequency distributions. Such sounds are often called "broadband," if the frequency distribution covers a wide range of frequencies. Figure 2-4 is an illustration of broadband random noise such as that of a waterfall or wheel/rail noise. The term "random" indicates that the magnitude of the noise cannot be precisely predicted for any instant of time. The rms value, usually determined by measurement, is the

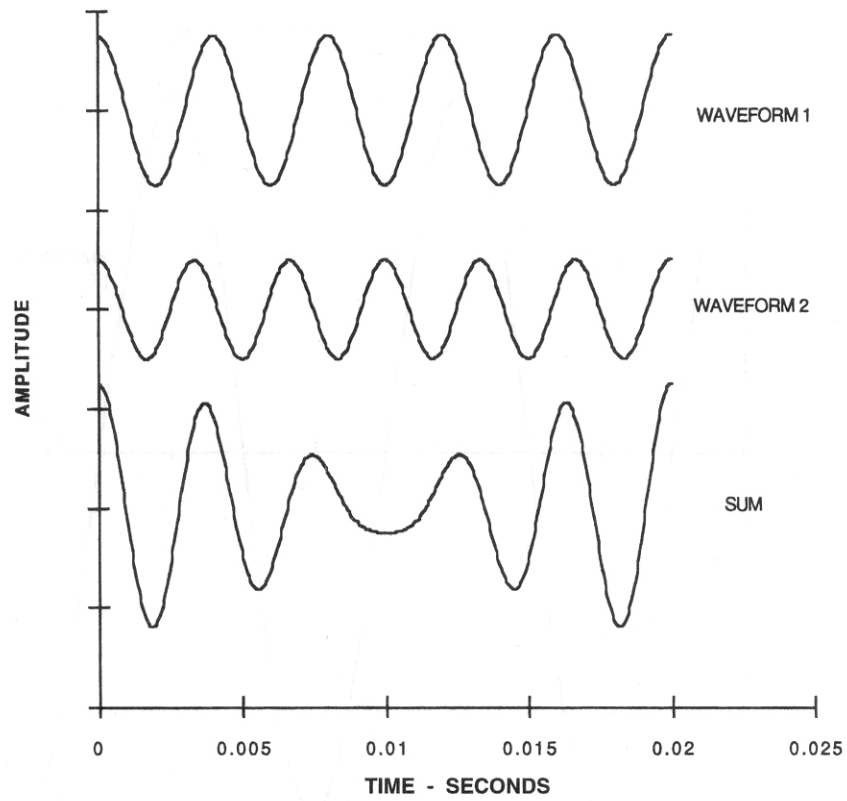

FIGURE 2-3 SUPERPOSITION OF TWO SINE WAVES OF FREQUENCY 250 HZ (WAVEFORM 1) AND 300 HZ (WAVEFORM 2)

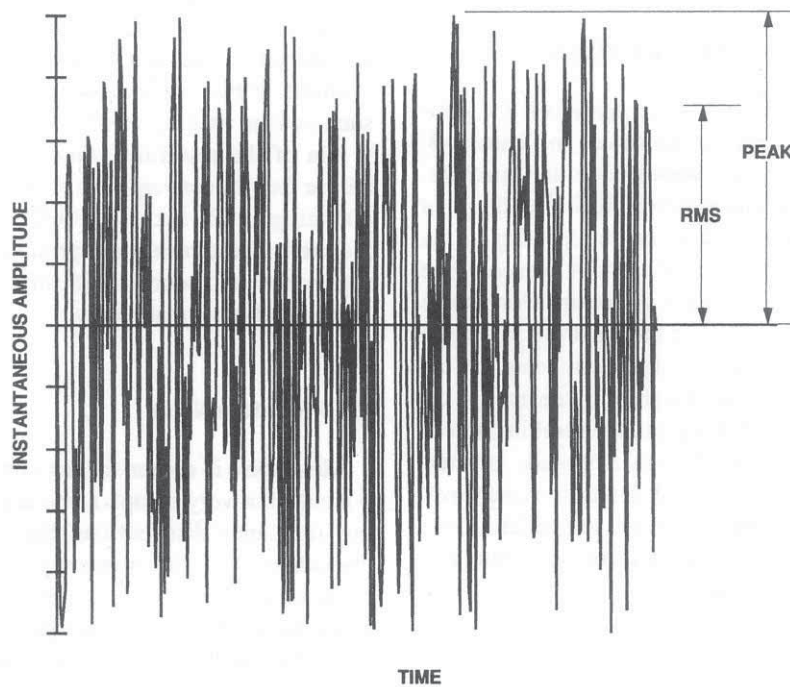

FIGURE 2-4 RANDOM WAVEFORM EXAMPLE

most common descriptor used for the amplitude of random, complex signals. The rms amplitude is the preferred metric for two reasons. First, the square of the rms amplitude of a sound is a measure of the sound energy. Second, the rms amplitude of a sound or vibration is well correlated with human response. The peak level is often an instantaneous event that occurs so rapidly the human perception mechanisms cannot respond.

As was previously mentioned, broadband sounds are composed of infinitely many simple sinusoidal waves. Thus, by extension of the formula for the rms amplitude of combined sine waves, the rms amplitude of combined broadband sounds is given by the above formula also. In the case of broadband signals, there is so much constructive and destructive interference that the opposing effects tend to cancel each other and the above expression is correct for even short periods of time (fractions of a second).

2.3.4 Decibel Levels

The human ear is capable of responding to a very wide range of sound pressures; at the threshold of pain the sound pressure is roughly 1 million times as large as the sound pressure at the threshold of hearing. Because there is such a large range of acoustic pressures that are of interest in noise measurements, the decibel (abbreviated dB) scale is used to compress the range of numeric values.

The general definition of the decibel is

$$L_w = 10 \text{ Log}_{10}(W/W_{\text{ref}})$$

where W is a quantity proportional to power, W_{ref} is a reference power, and L_w is the level in decibels, abbreviated as “dB.” The decibel is a ratio or relative measure; there must always be a reference quantity (W_{ref}) and the reference quantity must always be explicitly defined.

The decibel is used for quantities such as sound pressure level, sound power level, vibration acceleration level, and vibration velocity level. Whenever “level” is included in the name of a quantity, it indicates that the value is in decibels and that a reference power, pressure, or other quantity is stated or implied. The definition of Sound Pressure Level (SPL) is

$$L_p = \text{SPL} = 20 \log_{10}(p/p_0) = 10 \text{ Log}_{10}(p^2/p_0^2)$$

where p is the rms pressure for the sound in question. The square of the sound pressure, p^2 , is used because it is proportional to power, and decibels are typically used to indicate the ratio of two values of “power-like” quantities. The factor 20 is used when expressing the sound in terms of its pressure, or amplitude. The rms amplitude is employed most commonly. One may also employ a peak, a zero-to-peak, or a peak-to-peak amplitude. However, it is not reasonable to use the deci-

bel scale to describe the instantaneous time varying amplitude of a wave, since it crosses through “0”, and may be negative, for which the amplitude would not be defined. When using the decibel scale, the user is implying that the signal has been “detected” in some manner, such as by a sound-level meter.

Table 2–1 presents standard reference quantities used for noise and vibration measurements. For example, the reference sound pressure is 20 micro-Pascal, and the reference sound power is 10^{-12} Watt. The reference quantity for vibration is less clearly defined, but it is customary to employ 1 micro-g and 1 micro-in./sec for acceleration and vibration velocity, respectively, where “g” is the earth’s gravitational acceleration.

Since the decibel scale is logarithmic, the levels for two sounds are not added arithmetically. When adding two signals, their energies are first obtained and then added, and the resulting level is ten times the logarithm (base ten) of the energy sum. For example, if the power of one signal is 6×10^{-7} watts, and the power of the second signal is 7×10^{-7} watts, combining signals 1 and 2 creates a new signal with a power of 13×10^{-7} watts. The power *level* of the combined signals (with a reference level of 10^{-12} watts) is

$$\begin{aligned} LW = PWL &= 10 \text{ Log}_{10} [(6 \times 10^{-7} + 7 \times 10^{-7})/10^{-12}] \\ &= 61.1 \text{ dB} \end{aligned}$$

Thus, for example, the sound level for the sum of two sound pressures of level 90 dB is 93 dB.

Figure 2–5 presents a simple chart that can be used to perform decibel addition when the levels are given in decibels. As an example, consider adding the sound from two sources. Source A creates a level of 68 dB when source B is turned off and source B creates a level of 65 dB with source A turned off. Referring to Figure 2–5, the level difference is 3 dB, hence the combined level is 68 dB plus approximately 1.8 dB giving 69.8 dB.

When the values are given in decibels, the combined sound level, L_{total} , can also be calculated using the following relationship:

$$L_{\text{total}} = 10 \log(10_1^{(L/10)} + 10_2^{(L/10)})$$

Using this relationship, the example given above of adding 68 dB and 65 dB gives a combined level of 69.76 dB.

2.3.5 Weighted Sound Levels

The human ear does not respond in a uniform manner to different frequency sounds. For example, a sound pressure with level 70 dB will be perceived as much louder at 1,000 Hz than at 100 Hz. To account for this, various frequency weighting filters have been developed to reflect human sensitivity to the noise spectrum. The weighting filters de-emphasize the frequency ranges in which the human ear is

TABLE 2-1 REFERENCE QUANTITIES FOR SOUND AND VIBRATION

Name	Definition	Reference Quantities	
		SI	Typical US Practice
Sound Pressure Level	$20 \text{ Log}_{10}(p/p_0)$	20×10^{-6} Pascal	
Sound Power Level	$10 \text{ Log}_{10}(W/W_0)$	10^{-12} Watt	
Sound Intensity Level	$10 \text{ Log}_{10}(I/I_0)$	10^{-12} Watt/m ²	
Vibration Acceleration Level	$20 \text{ Log}_{10}(a/a_0)$	10^{-5} m/second	10^{-6} g
Vibration Velocity Level	$20 \text{ Log}_{10}(v/v_0)$	10^{-8} m/second	10^{-6} in/second
Vibration Displacement Level	$20 \text{ Log}_{10}(d/d_0)$	10^{-11} m	
Vibration Force Level	$20 \text{ Log}_{10}(F/F_0)$	10^{-6} N	1 lb
Energy	$10 \text{ Log}_{10}(E/E_0)$	10^{-12} J	

less sensitive. Figure 2-6 illustrates the weighting filter response curves that are commonly used with sound level meters. Sound pressure levels measured with a weighting network are generally referred to as “weighted sound levels.” Of these weighting curves, the A-weighting curve is the one most widely used for transit-related noise measurements and community noise descriptions. The A-weighted curve shown in Figure 2-6 is almost universally accepted as a standard metric for quantifying acoustic data in terms that can be related to the subjective effects of the noise. Although a number of relatively more complex techniques have been devel-

oped to describe human perception of sounds, psychoacoustic studies have shown these methods to be only marginally better than the use of A-weighted levels. For example, the *sones* and *phons* are measures of the *loudness* and *loudness level*, but, because of the complex steps required to calculate sones and phons, they are rarely used to evaluate transportation and community noise.

The A-weighted sound level, given in dBA relative to 20 micro-Pascal, is reasonably well correlated with human response to noise. As a general rule of thumb, a 2 dBA change in noise level is barely detected by the human ear.

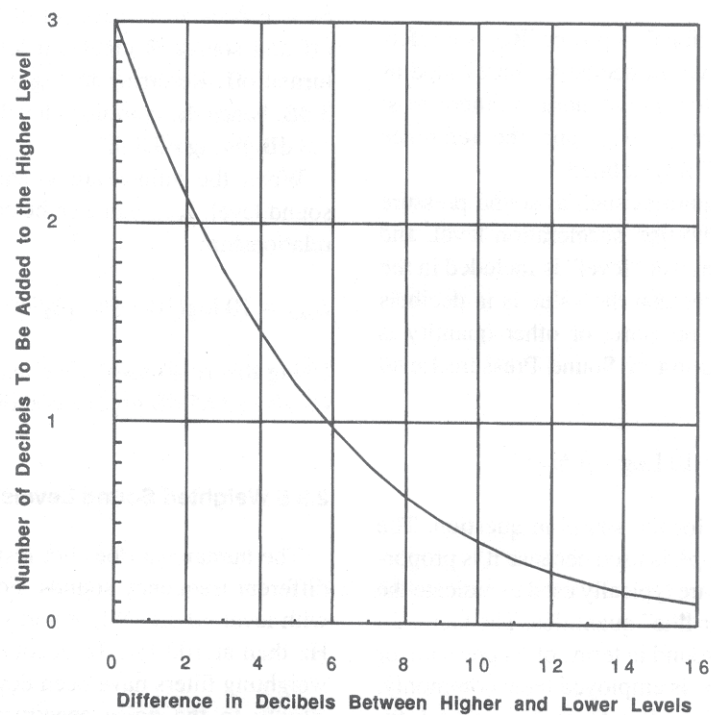

FIGURE 2-5 ENERGY SUMMATION OF LEVELS

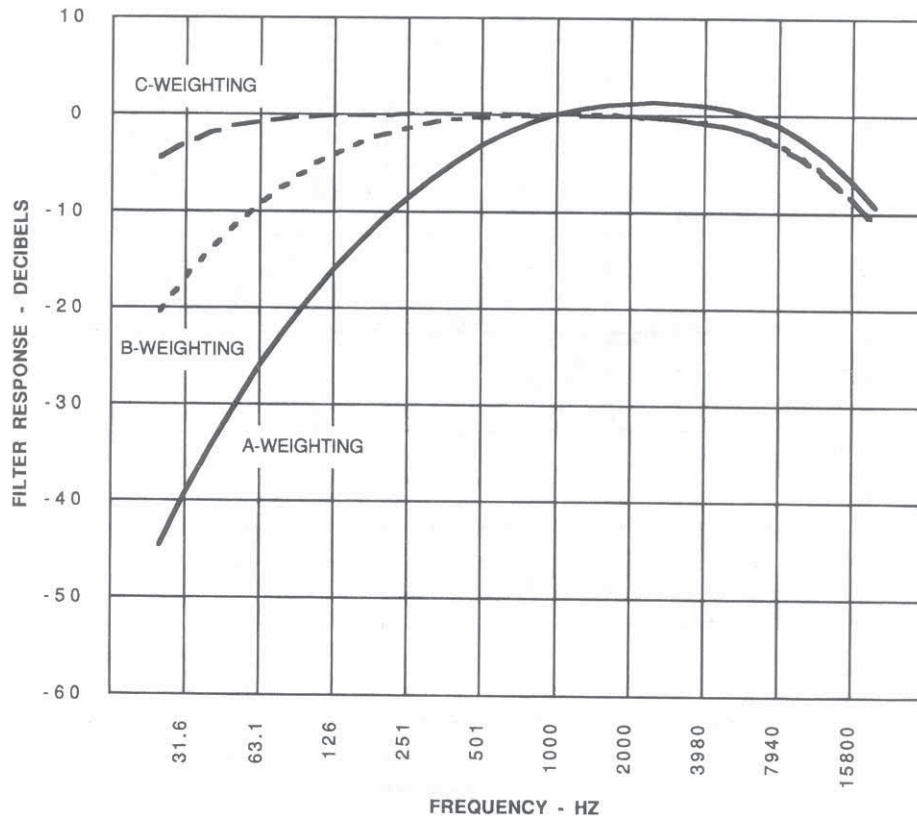

FIGURE 2-6 RESPONSE OF A-, B-, AND C-WEIGHTING NETWORKS

Over a long period of time a 3 to 5 dBA change is required before the change is noticeable. A change in sound level of 10 dBA will typically be judged as a subjective doubling or halving of the perceived loudness.

One notable disadvantage of the A-weighted sound level is that it does not accurately reflect the annoyance of audible pure tones, clicks, buzzes, rattles, and so on that may be part of a sound. Although the A-weighted levels of two sounds may be the same, sound with identifiable components or components which contain information will be considerably more distracting, annoying, and intrusive to most people than sounds which do not. A good example of this effect is the noise level of trains on jointed rail compared to welded rail. Although the A-weighted sound levels may be the same, the train on jointed rail will sound louder, and attract more attention, because of the joint impact noise. To account for this phenomenon, community noise ordinances typically include a 5 dBA penalty to be added to the measured level of noise that has identifiable pure tones or other annoying components.

2.3.6 Frequency Analysis

Additional information is often needed concerning the frequency content or spectral distribution of a sound. Spectral

analyses provide estimates of the sound energy as a function of frequency and are particularly useful to characterize a noise or vibration source and for designing noise control measures. There are several methods of analyzing the frequency distribution of a complex signal: octave band, 1/3-octave band, and constant bandwidth analyses. All of these charts represent analyses of the same signal, which consists of broadband noise with several tonal components (the strongest pure tone is at 1,000 Hz).

2.3.6.1 Octave and 1/3-Octave Analyses

Figure 2-7 is an example of a 1/3-octave band analyses. The vertical and horizontal scales follow standard conventions for plotting octave and 1/3-octave band data. These conventions specify that the vertical axis be scaled as 5 dB per centimeter, and that the horizontal axis be scaled as one 1/3 octave per 0.5 cm, or one octave per 1.5 cm. This standard format for presenting octave or 1/3-octave band data facilitates comparing different analyses by overlaying on a light table, or by holding up to a light. The left-hand scale indicates the bandwidth of the filters used for the analysis, for example, 1/3-octave band. Also indicated in Figure 2-7 are the overall and A-weighted sound levels corresponding to the 1/3-octave band spectrum.

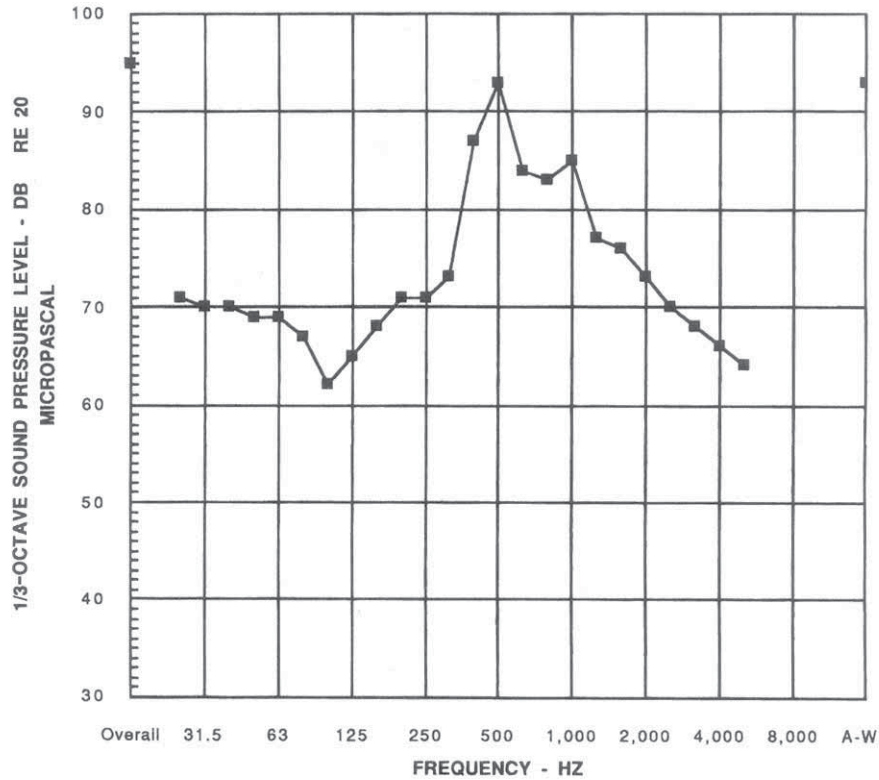

FIGURE 2-7 EXAMPLE OF 1/3-OCTAVE BAND ANALYSIS

Figure 2-8 shows the frequency response characteristic per American National Standards Institute (ANSI) specifications (8) for 3rd Order octave and 1/3-octave band filters. An octave covers a 2 to 1 ratio of frequencies, and each octave can be further subdivided into three 1/3-octaves to obtain more detail. Octave and 1/3-octave band filters are “constant percentage bandwidth” filters. The bandwidth of a 1/3-octave band filter is 23% of its nominal center frequency. The ideal octave band filter would pass the portion of the signal within the frequency band of interest and remove all other frequency components. Perfect (rectangular) filters are not possible, because realizable band pass filters do not have vertical skirts. However, they are reasonably well approximated by 6-pole analog (3rd Order) or digital filters, as employed by modern commercial 1/3-octave band analyzers.

The preferred frequency limits used for octave band and 1/3-octave bands are defined (9) by ANSI; these frequency limits are presented in Table 2-2. The center frequencies are generally used to reference specific octave and 1/3-octave bands.

Octave and 1/3-octave band analyses consist of contiguous non-overlapping frequency bands. For N contiguous frequency bands, the energy sum of the 1/3- or 1/1-octave band noise levels is the same as would be measured with one filter that covered the entire frequency range of the N filters. (If the individual filter response bandwidths did

overlap, or gaps existed between contiguous bands, as may be the case with narrow band constant bandwidth analyzers using weighting functions, the energies of the individual bands may not be so easily summed to obtain the total energy without inclusion of a correction.) In practice, three contiguous 1/3-octave band levels can be combined to obtain an equivalent octave band level for the octave band containing the three 1/3 octaves, and all of 1/3-octave band levels can be combined to obtain the equivalent overall level.

Octave band or 1/3-octave band analyses are relatively easy to perform with any number of commercial analyzers, and these analyses are often performed when simple frequency analysis is required. The use of 1/3-octave bands is usually preferable to octave band analysis, since 1/3-octave analysis provides more detail than octave band analysis. In Figure 2-7 the 1000 Hz pure tone could easily be overlooked in the octave band analysis, but it is clearly evident in the 1/3-octave band analysis.

When comparing 1/3-octave band levels with octave band levels, it is best to combine the 1/3-octave levels in groups of three to obtain equivalent octave band levels for comparison. However, another approach that is often used is to shift the octave band chart down by 5 dB to approximately convert from octave band levels to 1/3-octave band levels, assuming a constant energy per 1/3-octave band. The 5 dB factor (actu-

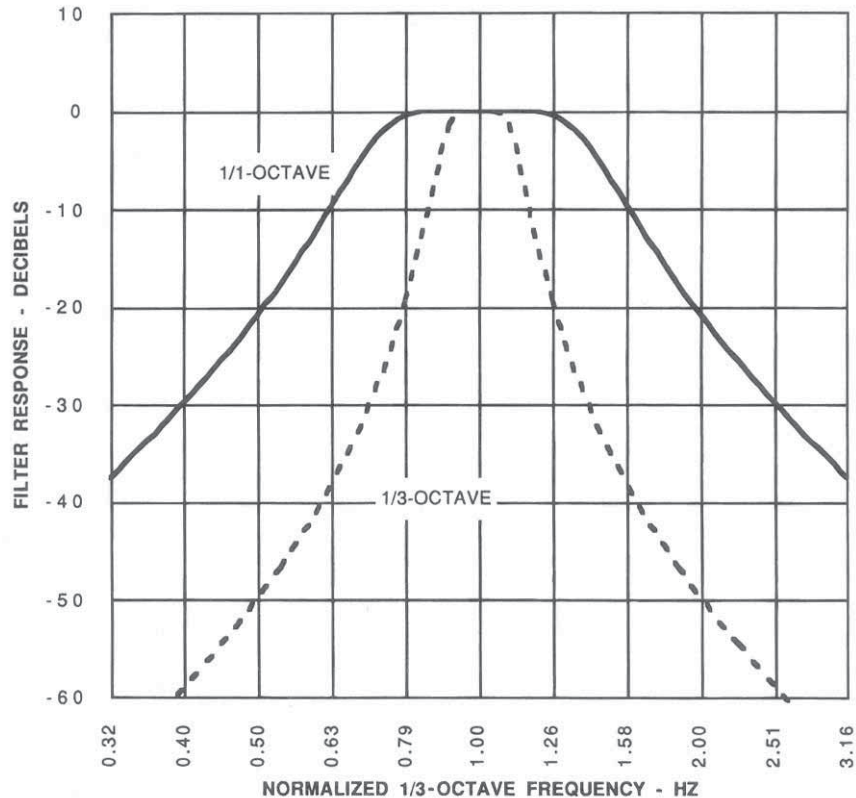

FIGURE 2-8 RESPONSE OF 1/3-OCTAVE AND 1/1-OCTAVE BAND FILTERS (ANSI SPECIFICATION S1.11-1986)

ally, 4.7 dB) is based on the assumption that the levels in the three 1/3-octaves in each octave are approximately equal. When the three 1/3-octave band levels are combined, the total is 5 dB higher. As illustrated in Figure 2-7, this assumption is reasonable except at the 1,000 Hz octave. Because the level of the 1,000 Hz 1/3-octave dominates the 1,000 Hz octave band, the level of the 1,000 Hz octave band is only 1 dB above the level of the 1,000 Hz 1/3-octave band.

2.3.6.2 Constant Bandwidth Analyses

Figure 2-9 is an example of constant bandwidth narrow-band analysis of wayside passby noise using a Fast Fourier Transform (FFT) analyzer, referred often to as a *Fourier analyzer*. The advantage of this type of frequency analysis is that each of the spectral components of the acoustical data is clearly described and identified, so that sources of specific discrete frequency components may be more easily identified. Thus, the frequency of wheel squeal may be precisely defined and correlated with natural modes of vibration of the wheel. In Figure 2-9, the wayside noise contains a series of discrete frequency components between 500 and 900 Hz which may related to corrugation,

anti-resonance in the wheel, or other mechanical characteristic. A broadband peak exists between 1,000 and 2,000 Hz, which might be related to resonances or anti-resonances of the wheel. Thus, narrowband analyses provide a means of characterizing types of noise and identifying noise sources.

The left-hand scale of Figure 2-9 indicates the quantity being displayed. In this case, the scale indicates that the noise levels are of the acoustic energies passed by filters with an effective noise bandwidth of 15 Hz. Filters with other bandwidths can be employed for analyzing noise, or vibration, as discussed below. The analyses actually includes 400 spectral "lines" separated by 10 Hz, with each line representing a filter with bandwidth 15 Hz. Thus, there is some overlap of the spectral lines, which must be taken into account when summing the spectral energies to obtain the total energy of the analyses. In this case, the energy sum of the spectral components, or lines, must be reduced by about 1.8 dB to give the total energy.

The 1/3-octave bands at 40, 400, and 4,000 Hz have effective noise bandwidths of 9.26, 92.6, 926 Hz, respectively. Thus, a constant bandwidth analyzer with a 20 Hz resolution bandwidth has much higher resolution than the 1/3-octave band filter at 4,000 Hz. At very low frequencies, however, the constant bandwidth analysis has much less resolution than the 1/3-octave analysis.

TABLE 2-2 ONE-THIRD OCTAVE BAND CENTER AND EDGE FREQUENCIES

Band	Frequency - Hz					
	Octave			One-third Octave		
	Lower Band Limit	Center	Upper Band Limit	Lower Band Limit	Center	Upper Band Limit
12	11	16	22	14.1	16	17.8
13				17.8	20	22.4
14				22.4	25	28.2
15	22	31.5	44	28.2	31.5	35.5
16				35.5	40	44.7
17				44.7	50	56.2
18	44	63	88	56.2	63	70.8
19				70.8	80	89.1
20				89.1	100	112
21	88	125	177	112	125	141
22				141	160	178
23				178	200	224
24	177	250	355	224	250	282
25				282	315	355
26				355	400	447
27	355	500	710	447	500	562
28				562	630	708
29				708	800	891
30	710	1000	1420	891	1000	1122
31				1122	1250	1413
32				1413	1600	1778
33	1420	2000	2840	1778	2000	2239
34				2239	2500	2818
35				2818	3150	3548
36	2840	4000	5680	3548	4000	4467
37				4467	5000	5623
38				5623	6300	7079
39	5680	8000	11360	7079	8000	8913
40				8913	10000	11220
41				11220	12500	14130
42	11360	16000	22720	14130	16000	17780
43				17780	20000	22390

2.3.6.3 Spectrum Level and Power Spectral Density

The results of narrowband frequency analyses are commonly presented in terms of *spectrum level* or *power spectral density* (PSD). The spectrum level of a noise is the level that would be measured if an analyzer had an ideal filter response characteristic with a bandwidth of 1 Hz at all frequencies. In other words, the level is normalized to a bandwidth of 1 Hz. The spectrum in Figure 2-9 can be converted to a power spectral density level, or spectrum level, plot by subtracting 11.8 dB ($10 \log_{10}[\text{Effective Noise Bandwidth}]$). However, if the effective noise bandwidth exceeds the “line” width of the actual discrete frequency component, the result will be in error, since the power spectral density is not defined for discrete frequency components. *Normalized levels*, such as the spectrum level, or power spectral density, are not accurate for characterizing discrete frequency components. Mathematically, the *spectral density* of a discrete frequency component of noise is infinite. Therefore, when displaying spectral data with discrete frequency components, the data should not be normalized for filter bandwidth. The main uses of the power spectral density or spectrum level for-

mat are (1) comparing data taken with analyzers with different analysis bandwidths and (2) checking compliance with specifications given in terms of spectrum level.

2.4 CHARACTERIZING NOISE ENVIRONMENTS

Noise produced by any transit system must be characterized to determine the need for mitigation. The field of acoustics is replete with descriptors and methods for doing this, largely because of the many types of noise and the difficulty in assessing human responses to noise. Some of the descriptors that are used are described below.

2.4.1 Noise Criterion Curves

The Noise Criterion (NC) curves are commonly used for noise criteria indoors and are widely used in architectural specifications for HVAC systems. The NC curves are illustrated in Figure 2-10. The NC curves are used by plotting the octave band levels against the NC curves, and the NC level for a par-

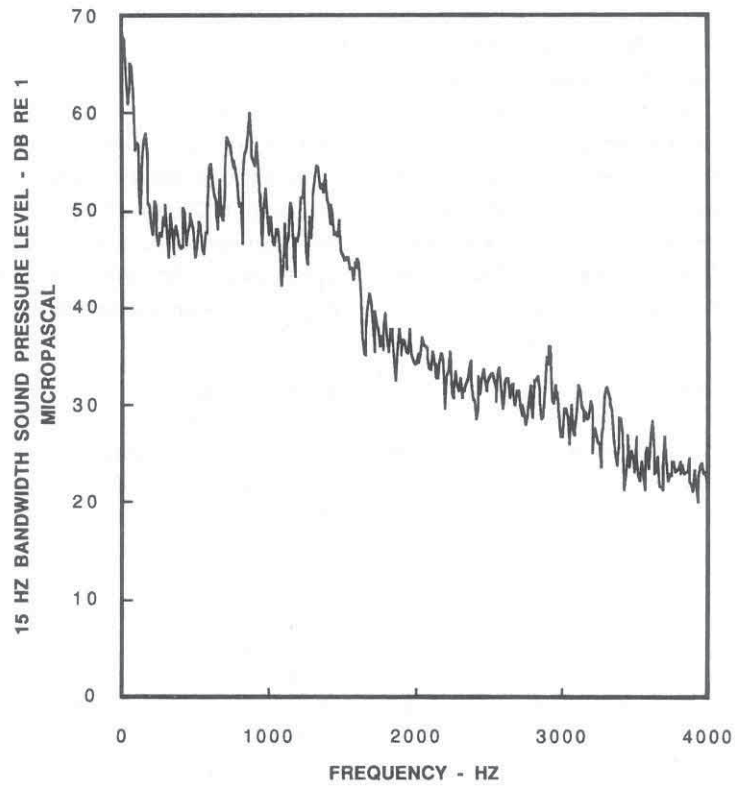

FIGURE 2-9 EXAMPLE OF FOURIER SPECTRAL ANALYSIS

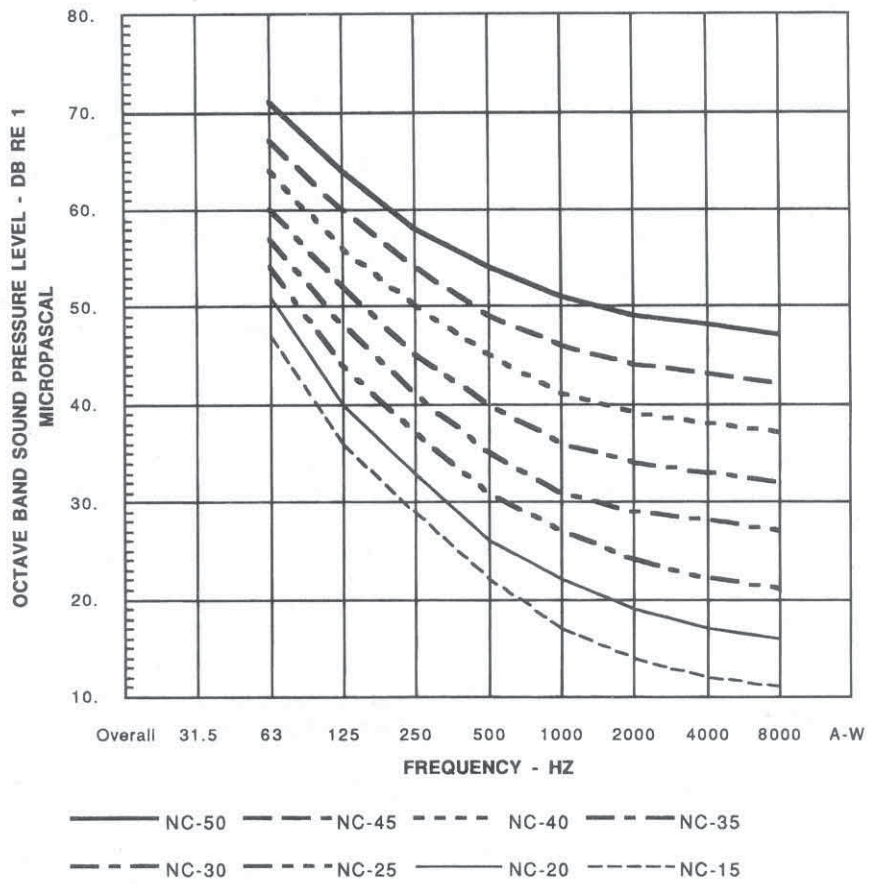

FIGURE 2-10 NOISE CRITERIA CURVES

ticular octave band spectrum is the maximum NC curve that the spectrum touches. Hence, using the NC curves gives a rating for the acceptability of an acoustic environment and indicates the octave band that dominates the overall rating. Another form of the NC curves called the preferred noise criteria (PNC) curves, designed to overcome some objections to the NC curves, are also occasionally encountered. The NC curves can be used to specify noise environments or evaluate noise consisting of broadband and pure tones, and have been applied to rail transit groundborne noise in buildings.

2.4.2 Energy Equivalent Levels

Because noise, particularly outdoor noise, varies with time, there is a need for measures of noise that account for these variations. The most popular measures are based on an energy dose, or equivalent noise energy, principle. An energy dose or equivalent energy level is mathematically attractive for combining the sound energies of differing sources or events. Several of these noise descriptors are defined below:

Equivalent Sound Level— L_{eq} . Sometimes referred to as the energy average sound level over the period of interest, L_{eq} is widely accepted as a valid measure of community noise. The equivalent sound level is equal to the equivalent steady noise level which in a stated time period would contain the same energy as time-varying noise during the same time period. Mathematically, it is defined as

$$L_{eq} = 10 \text{Log}_{10} \left[\frac{1}{t_2 - t_1} \int_{t_1}^{t_2} \frac{p^2(t)}{p_0^2} dt \right]$$

where $p(t)$ is the time varying pressure and p_0 is the standard reference pressure of 20 micro-Pa (2×10^{-5} N/m²). This is mathematically equivalent to the definition of rms level given above. However, “rms” is typically used for much shorter periods of time than L_{eq} . The average sound level over a period of time T is often symbolized as $L_{eq}(T)$. Commonly used descriptors are

- $L_{eq}(h)$ = hourly averaged sound level
- $L_{eq}(8h)$ = 8-hour averaged sound level
- $L_{eq}(d)$ = average daytime sound level
- $L_{eq}(n)$ = average nighttime sound level

The term “average” indicates energy average.

Day-Night Average Sound Level— L_{dn} . L_{dn} is a 24-hour average sound level in which the nighttime noise levels occurring between 10:00 P.M. and 7:00 A.M. are increased by 10 dBA before calculation of the 24-hour average. The 10 dBA *penalty* is included to account for people’s increased sensitivity to noise during the nighttime hours when many people are asleep and the background noise is low. L_{dn} is the

primary measure used for describing noise in Environmental Impact Statements.

Community Noise Equivalent Level (CNEL). CNEL is similar to the L_{dn} except that the 24-hour period is broken into three periods: day (0700 to 1900), evening (1900 to 2200), and night (2200 to 0700). Penalties of 5 dBA are applied to the evening period and 10 dBA to the nighttime period. In most cases, CNEL will be less than 0.5 dBA higher than the L_{dn} , an insignificant difference which is often ignored.

2.4.3 Histograms

Figure 2–11 illustrates the statistical distribution, or histogram, of fluctuating community noise. The vertical axis is the percentage of time that the noise level indicated on the horizontal axis is exceeded. Adding a transient noise source such as rapid transit trains that create relatively high noise levels for relatively short periods of time will modify the histogram as indicated in the figure. The train noise increased the level exceeded 1% of the time, but left the level exceeded 10% of the time unchanged.

Histograms may be represented by *levels exceeded “n” percent of the time, or L_n* . The level exceeded n-percent of time is a widely used measure of environmental noise. Typical measures are L_1 , L_{10} , L_{50} , L_{90} , and L_{99} . The time period can range from a full 24-hour period to a several minute spot check. To avoid confusion, the time period should be clearly specified. The statistical levels are usually determined from histograms developed with the “fast” sound-level meter response, or rms averaging time of 1 sec. In practice, the “slow” meter response is often used. This will affect the extreme ends of the histogram, but should not affect the L_{10} or L_{50} significantly.

The levels exceeded 50% of the time are largely unaffected by transient events which, together, occur over a period of time less than 30 min in any hour. For this reason, the median noise level, L_{50} , is a *robust descriptor* of time varying community noise levels against which transient noise levels may be projected. The L_1 is often used to describe the “maximum level,” and the L_{90} is often used to describe the background sound level.

Histograms are usually developed for A-weighted sound levels, but can be developed for 1/3-octave, and octave sound levels, as well as for vibration levels. Histograms and the related L_n ’s are one of the most practical tools available for describing nonstationary, or time varying, community noise.

2.5 SOUND ABSORPTION AND TRANSMISSION

Sound absorption and sound isolation are commonly misunderstood parameters. Sound absorption refers to the ability of materials, such as fiberglass blankets or acoustical tile, to convert sound energy into heat. Sound absorbing materi-

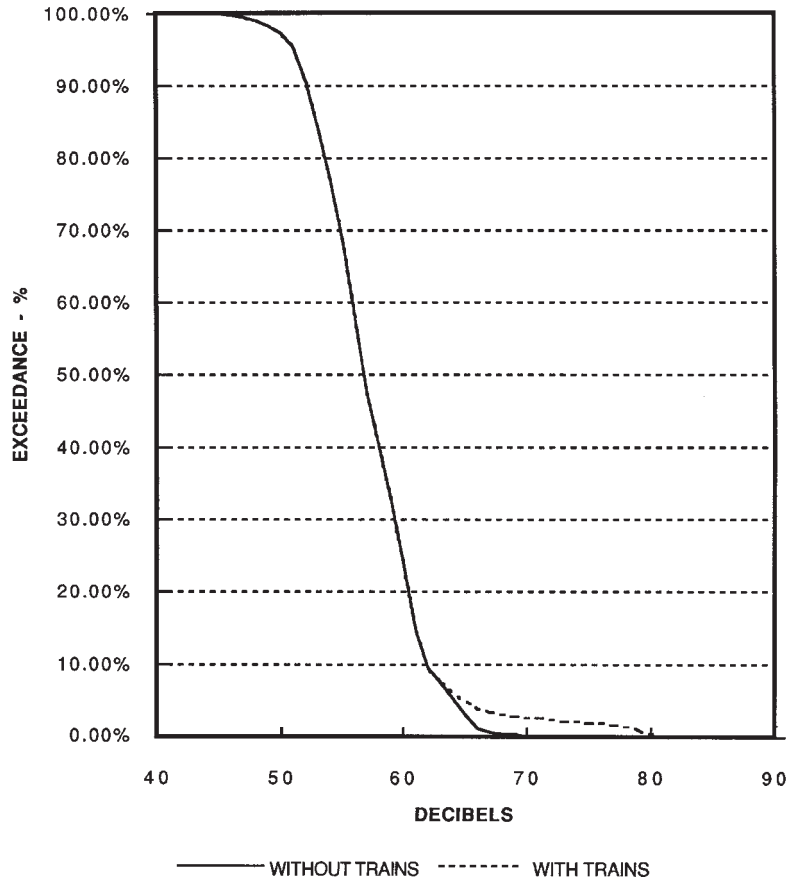

FIGURE 2-11 HISTOGRAM OF COMMUNITY NOISE LEVELS

als reduce sound reflected from a surface by dissipating acoustical energy in the material. Porous materials do not stop, block, or contain sound. If air passes through or around a material, so can sound. Sound transmission loss refers to the ability of a partition or barrier to attenuate sound as it transmits through. A material must be massive and airtight to effectively isolate sound.

Figure 2-12 illustrates the reflection and transmission of sound energy. The incident sound intensity impinges on the wall. Part of the sound intensity is transmitted through the wall, and part of the sound power is reflected from the wall. Another part is absorbed in the wall. The absorption coefficient of the wall determines the intensity of the reflected sound relative to the intensity of the incident sound, includes the effect of both the sound intensity transmitted through the wall as well as the sound intensity absorbed by the material in the wall. The sound absorption coefficient is always between 0 and 1, though published values of the coefficient may exceed 1 because of the methods of measurement. The transmission coefficient is the ratio of transmitted sound intensity to incident sound intensity, and is always between 0 and 1. The sound transmission loss in decibels is a convenient descriptor of the sound isolation qualities of the wall. These quantities are mathematically defined as

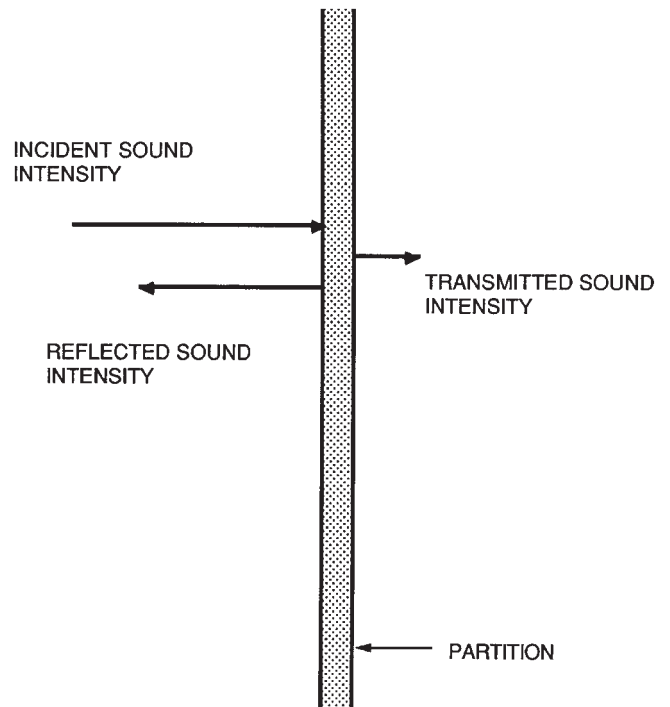

FIGURE 2-12 REFLECTION AND TRANSMISSION OF ACOUSTIC ENERGY

$$\begin{aligned}\text{Sound Absorption Coefficient } (\alpha) &= 1 - I_{\text{reflected}}/I_{\text{incident}}^2 \\ \text{Transmission Coefficient } (\tau) &= I_{\text{Transmitted}}/I_{\text{Incident}} \\ \text{Transmission Loss in Decibels (TL)} &= 10 \text{ Log } (1/\tau)\end{aligned}$$

An absorption coefficient of zero indicates perfect reflection of incident sound energy. An absorption coefficient of one indicates a perfectly nonreflecting wall, which may be due to complete absorption of sound energy, perfect transmission of sound energy through the wall, or a combination of both which produces a nonreflecting wall. For example, an opening in a wall would have an absorption coefficient of one. (Actually, at long wavelengths relative to the dimension of the opening, the absorption coefficient may exceed one.)

The sound absorptive properties of a material depend on the porosity and thickness, or dynamic response, of the material, and the angle at which the sound waves strike the material. For convenience, the reported absorption coefficient is generally the average over all angles of incidence, sometimes referred to as the random incidence absorption coefficient.

2.5.1 Sound Transmission Loss

The sound transmission loss (TL) represents the loss in decibels of the sound intensity as it transmits through the wall or barrier. Sound transmission loss is given in decibels. A wall with a large sound transmission loss is a very effective sound isolator, and a wall with zero transmission loss is acoustically transparent.

2.5.2 Sabine Absorption Coefficient

The Sabine absorption coefficient is very similar to the absorption coefficient defined above, but is the absorption coefficient determined for a patch of material placed on the floor of a reverberation chamber. The Sabine absorption coefficient is often greater than one, owing to the method of measurement. More discussion of the Sabine absorption coefficient can be found in Beranek's work (2).

2.5.3 Noise Reduction Coefficient–NRC

The noise reduction coefficient, or NRC, is a single-number descriptor of the sound absorbing properties of various materials. The NRC is the arithmetic average of the "Sabine absorption coefficients" at 250, 500, 1,000 and 2,000 Hz.

2.5.4 Sound Transmission Class–STC

The sound transmission class, or STC, is a single-number descriptor of the sound transmission losses of partitions. Information on determining the STC can be found in Beranek's work, referenced above. As a general rule, partitions with high values of STC have high sound transmission losses.

2.5.5 Materials and Mounting

Materials such as glass-fiber insulation have high absorption coefficients but very low transmission loss, while solid materials such as concrete have relatively high transmission loss but very low absorption coefficients. Mounting glass-fiber blankets on a concrete wall will result in both high transmission loss and high absorption. Manufacturers provide data on the sound absorption coefficients and sound transmission losses of various materials and partitions. More discussion is provided concerning sound transmission loss and sound absorption coefficient where appropriate, specifically in the chapters concerning station and vent shaft treatments, and vehicle noise control.

2.6 REFERENCES

1. Harris, C. M. ed., *Handbook of Noise Control*, 2nd edition McGraw-Hill Book Company, New York, NY (1979).
2. Beranek, L.L. ed., *Noise and Vibration Control*, McGraw-Hill Book Company, New York, NY (1971).
3. Rettinger, M. *Acoustic Design and Noise Control*, Vols. 1 and 2, Chemical Publishing Co., New York, NY (1977).
4. Kinsler, L. and A. Frey, *Fundamentals of Acoustics*, John Wiley and Sons, New York, NY (1962).
5. *Transportation Noise and Its Control*, U.S. Government Printing Office, Washington, DC, stock No. 5000-0057, U.S. DOT, Office of the Secretary, Washington, DC (1972).
6. Lutz, R. *Theory and Practical Application of Noise and Vibration Abatement for Railway Vehicles*, Report DT 25/E, Office for Research and Experiments of the International Union of Railways, ORE (April 1976).
7. Saurenman, H. J., J. T. Nelson, and G. P. Wilson, *Handbook of Urban Rail Noise and Vibration Control*, prepared by Wilson, Ihrig & Associates, Inc., for U.S.DOT, UMTA, DOT-TSC-UMTA-81-72. NTIS No. UMTA-MA-06-0099-82-1 (February 1982).
8. American National Standards Institute Specification ANSI S1.11 (1986).
9. American National Standards Institute Specification ANSI S1.6 (1967).

CHAPTER 3 DESIGN GUIDELINES

- 3.1 Introduction, 25
- 3.2 American Public Transit Association, 25
 - 3.2.1 Wayside Noise Limits, 25
 - 3.2.1.1 Community Categories, 25
 - 3.2.1.2 Measurement of Wayside Passby Noise, 25
 - 3.2.1.3 Relation to Equivalent Levels— L_{eq} , 27
 - 3.2.2 Ancillary Facility Noise, 27
 - 3.2.3 Station Platform Noise Levels, 27
 - 3.2.4 Transit Vehicle Noise Limits, 27
- 3.3 Federal Transit Administration, 27
 - 3.3.1 Transit System Projects, 28
 - 3.3.1.1 Basis, 30
 - 3.3.1.2 Land Use Categories, 30
 - 3.3.1.3 Levels of Impact, 31
 - 3.3.1.4 Mitigating Adverse Impact, 31
- 3.4 Local Ordinances, 31
- 3.5 Preparation of Noise Specifications, 31
- 3.6 References, 32

This page left intentionally blank.

CHAPTER 3

DESIGN GUIDELINES

3.1 INTRODUCTION

Environmental impact analysis and design guidelines are discussed in this chapter. Included are (a) the design guidelines published by APTA and (b) the guidelines recently published by the FTA for environmental assessment and design of rail transit projects and highway/transit corridor projects. The FTA provides criteria for assessing and comparing noise impacts of various transportation modes, including bus as well as ancillary facilities of transit systems. Also discussed in this chapter are local ordinances and the preparation of noise specifications for transit equipment.

3.2 AMERICAN PUBLIC TRANSIT ASSOCIATION

APTA provides design guidelines for noise produced by transit trains. These guidelines are comprehensive; they include limits for vehicle interior, exterior, station platform, and fan and vent shaft noise levels (*I*). (Noise level limits are also provided for fan noise and substation noise.)

3.2.1 Wayside Noise Limits

Wayside noise limits are recommended by APTA, based on community categories and building types.

3.2.1.1 Community Categories

Community categories defined by the APTA guidelines are listed in Table 3–1 in terms of description and median L_{50} sound levels. These basic community categories serve as a basis for recommending appropriate noise level limits. Each community category is assigned a range of ambient median sound levels, L_{50} , as part of its description, which forms a basis for assigning rail transit noise limits. The noise limits are intended to limit maximum passby noise to levels consistent with other modes of transportation, such as automobiles passing along streets in front of residential receivers. Design guidelines for maximum rail transit noise are then selected for the type of community.

Design guidelines for maximum passby noise levels are provided in Table 3–2 for various types of communities and occupancies. The APTA guidelines place a limit on maxi-

imum sound levels so that they are comparable to other sources of noise, such as automobiles and light trucks. These limits are applied to nighttime operations, because the sensitivity to noise is greater at night than during daytime hours. In practice, wheel/rail noise will be independent of the time of day. The noise limits apply outdoors at the building or area under consideration, but not closer than 50 ft from the (nearest) track centerline. At locations where the train noise has no particularly annoying or identifiable components, experience with the noise level guidelines given in Table 3–2 has shown that the community will usually accept the resulting noise environment if the maximum noise level design goals are met, in spite of the transient nature of wheel/rail noise. More importantly, the APTA guidelines can be met with practical noise control provisions.

Maximum sound levels for specific types of buildings are indicated in Table 3–3. These limits should be applied regardless of the community area category involved. The designer should be careful in locating surface or aerial transit lines adjacent to auditoria, television studios, schools, theaters, amphitheatres, and churches.

At locations where noise from impacts at jointed track or crossovers, wheel squeal on curves, and so on occur, the noise will be more annoying than usual. The APTA guidelines make no provision for these types of noise.

3.2.1.2 Measurement of Wayside Passby Noise

The maximum sound level is defined as the maximum sound level measured with a sound level meter set to the “fast meter response,” which is similar to an rms averaging time of 0.125 sec. In practice, the rms sound level is often determined by averaging the sound energy over the passby duration to average out minor fluctuations in sound level due to abnormally rough wheels, impacts, etc., as might be done with an integrating sound level meter or real time analyzer. Minor fluctuations of noise level can also be energy averaged using the “slow” sound level meter response characteristic, equivalent to an rms averaging time of 1 sec. The difference between the “slow” sound-level meter measurement and the “fast” sound-level meter measurement for a smoothly varying train passby signature is a fraction of a decibel. A problem may arise, however when measuring the maximum sound level using the slow meter response for very rapidly

TABLE 3-1 GENERAL CATEGORIES OF COMMUNITIES ALONG TRANSIT SYSTEM CORRIDORS (APTA)

Area Category	Area Description	Typical L ₅₀ dBA	
		Day	Night
I	<u>Low Density</u> urban residential, open space, park, suburban	40-50	35-45
II	<u>Average</u> urban residential, quiet apartment and hotels, open space, suburban residential, or occupied outdoor area near busy streets.	45-55	40-50
III	<u>High density</u> urban residential, average semi-residential/commercial areas, parks, museums and non-commercial public building areas.	50-60	45-55
IV	<u>Commercial</u> areas with office buildings, retail stores, etc., primarily daytime occupancy	60-70	Not Applicable
V	<u>Industrial</u> areas or freeway and highway corridors	>60	Not Applicable

L₅₀ is the median noise level. The energy equivalent noise level during the day is typically about 3 to 5 dB higher than the L₅₀.

TABLE 3-2 GUIDELINES FOR MAXIMUM AIRBORNE NOISE FROM TRAIN OPERATIONS (APTA)

Community Area Category	Description	Single Event Maximum Noise Level Design Goal - dBA		
		Single Family Dwellings	Multi-Family Dwellings	Commercial Buildings
I	Low Density Residential	70	75	80
II	Average Density Residential	75	75	80
III	High Density Residential	75	80	85
IV	Commercial	80	80	85
V	Industrial /Highway	80	85	85

Note: These limits apply at the structure or sensitive area, but not closer than 50 feet from the track centerline.

TABLE 3-3 GUIDELINES FOR MAXIMUM AIRBORNE NOISE AT SPECIFIC BUILDINGS FROM TRAIN OPERATIONS (APTA)

Building Occupancy	Single Event Maximum Noise Design Goal - dBA
Amphitheaters	60
"Quiet" Outdoor Recreation Areas	65
Concert Halls, Radio and TV Studios, Auditoria	70
Churches, Theaters, Schools, Hospitals, Museums, Libraries	75

rising passby noise levels, in which case the fast sound-level meter response should be used. Most trains require at least 1 sec to pass a measurement location, a time that is consistent with the slow meter response. The slow meter response is entirely adequate for measuring maximum passby noise from heavy rail transit trains of four or more cars at distances beyond one car length.

3.2.1.3 Relation to Equivalent Levels – L_{eq}

The maximum noise level limits indicated by the APTA guidelines limits may be correlated with energy averaged noise levels for the purpose of assessing community reaction to noise. The following formula by Peters (2) is useful to relate the maximum passby level measured with a sound level meter set to “fast” response (0.125 sec integration time) with the energy averaged L_{eq} over an extended period:

$$L_{eq} = L_{max} + 10 \text{Log}_{10}\{R(1.5D + d)/v\} - 30$$

where:

- R = number of trains per hour
- D = distance of the receiver from the track centerline
- d = average train length in meters
- v = train speed in km/hr.

As an example, if the 70 dBA design limit is just met at a location 60 m from the track, with train speed of 96 km/hr, and average train length of 91 m, then an L_{dn} of 55 dBA would be obtained with an average of 16 trains per hour during the daytime (7:00 AM to 10:00 PM) and 1.5 trains per hour at night.

For the most part, the APTA guidelines for community noise levels due to transit trains agree with the goals of the Environmental Protection Agency (EPA) “Levels Document” (3). Meeting the APTA maximum noise level goals for residential locations will not necessarily guarantee that the Day-Night Levels identified in the “Levels Document” as “requisite to protect the public health and welfare with an adequate margin of safety” will be achieved. Even if the maximum level goals of the APTA guidelines are achieved, the Day-Night Levels will depend on scheduling, especially on the number of trains passing during the nighttime period.

3.2.2 Ancillary Facility Noise

The APTA guidelines provide noise level limits for ancillary facilities, including vent and fan shafts through which wheel/rail noise may propagate and impact normally quiet residential communities. The maximum limits for transient noise emanating from fan and vent shafts due to train operations are listed in Table 3–4. These limits apply at the shorter distance of 50 ft from the ancillary facility or at the setback line of the nearest building.

3.2.3 Station Platform Noise Levels

The APTA guidelines recommendations for station platform noise levels due to trains are summarized in Table 3–5. Trains entering and leaving subway stations should not produce noise levels in excess of 85 dBA. The noise level limits for above grade stations are 80 and 85 dBA for ballast-and-tie and concrete track beds, respectively. Noise levels 5 dB below these limits are desirable. Platform noise levels are normally measured at 5 ft above the platform, roughly midway between the platform edge and rear wall, or 5 ft from the platform edge, whichever is closer to the track. The noise levels apply to the total noise level, including noise due to wheel/rail sources as well as traction motor equipment, vehicle ventilation and air conditioning equipment, and brake systems. (The APTA guidelines also provide limits for continuous noise levels due to station and subway ventilation fans, and recommend station reverberation times to control speech intelligibility of public address systems.)

3.2.4 Transit Vehicle Noise Limits

Interior and exterior vehicle noise generally have separate standards, though the sources are the same. The APTA guidelines recommend limits for vehicle interior and exterior operational maximum A-weighted noise levels at maximum operating speeds on ballast-and-tie and concrete track beds. These limits are listed in Table 3–6. (The APTA guidelines also recommend maximum auxiliary equipment noise levels for stationary vehicles.) These limits are incorporated into many transit vehicle procurement specifications. The goal of the APTA guidelines is that vehicles be constructed to minimize wayside and interior noise levels. Further, the limits given in Table 3–6 apply to the total noise produced by the transit vehicle, not just wheel/rail noise. Much of the noise produced by a transit vehicle on ballast-and-tie track with smooth ground rail is produced by traction motor equipment and aerodynamic turbulence in the truck area. Subjectively, meeting the APTA guidelines for interior noise levels means that the interior noise on ballast-and-tie track at low speeds should be “quiet” while at high speeds in subway the noise may be “intrusive” but not “annoying” (4). These levels are consistent with those of all but the quietest of automobiles at highway speeds.

3.3 FEDERAL TRANSIT ADMINISTRATION

The FTA provides comprehensive guidelines for environmental assessment of proposed transit projects in a report entitled *Transit Noise and Vibration Impact Assessment* (5), referred to informally as the “guidance manual.” The FTA guidelines recommend procedures for assessing transit noise impacts due to all forms of transit, including rail transit. The FTA expects project sponsors to use these guidelines for rail projects which involve funding assistance from the FTA.

The purpose of this section is to introduce and summarize the FTA guidance for environmental noise impact assessment.

TABLE 3-4 GUIDELINES FOR NOISE FROM TRANSIT SYSTEM ANCILLARY FACILITIES (APTA, TABLE 2-7-G)

Area Category	Area Description	Maximum Transient Noise Level due to Trains - dBA
I	Low Density Residential	50
II	Average Density Residential	55
III	High Density Residential	60
IV	Commercial	65
V	Industrial/Highway	75

TABLE 3-5 PLATFORM NOISE LEVEL LIMITS MEASURED AT 5 FEET ABOVE THE PLATFORM, 5 FEET FROM PLATFORM EDGE OR CENTERLINE, WHICHEVER IS CLOSEST TO THE TRACK (APTA)

Station Type	Track Type	Maximum Noise Level - dBA
Subway	Concrete	85
Above Grade	Concrete	85
	Ballast-and-tie	80

TABLE 3-6 SUMMARY OF TRANSIT VEHICLE OPERATIONAL NOISE LEVEL DESIGN GOALS (APTA, TABLE 2-7-A)

Specification	Item	Goal - dBA		
		2-Car	4-Car	6- or 8-Car
Vehicle Interior Noise Limits	In open (ballast and tie) at maximum speed on welded rail (+5 dBA on jointed rail)	70		
	In open (concrete track bed) at maximum speed	74		
	In tunnels at maximum speed	80		
Exterior Noise Limits (15 m from track centerline in open with no reflecting surface within 100 feet of test location)	Ballast and tie track - 80 mph	84	86	87
	Ballast and tie track - 60 mph	80	82	83
	Concrete Track bed - 80 mph	88	90	91
	Concrete track bed - 60 mph	85	87	88

The user of this manual should refer directly to the above-referenced report when trying to interpret and apply FTA's noise prediction procedures and impact assessment criteria.

3.3.1 Transit System Projects

The FTA criteria for assessing the environmental noise impact of transit system projects are shown in Figure 3-1 for

categories of land use defined in Table 3-7. The project noise levels are indicated along the ordinate, and the existing ambient, or no-build, noise levels are indicated along the abscissa. Thus, for example, the noise due just to transit operations can be plotted against the ambient noise without transit operations, and if the point falls within the "impact" zone, the transit noise would be deemed to produce an impact, though not a "severe impact."

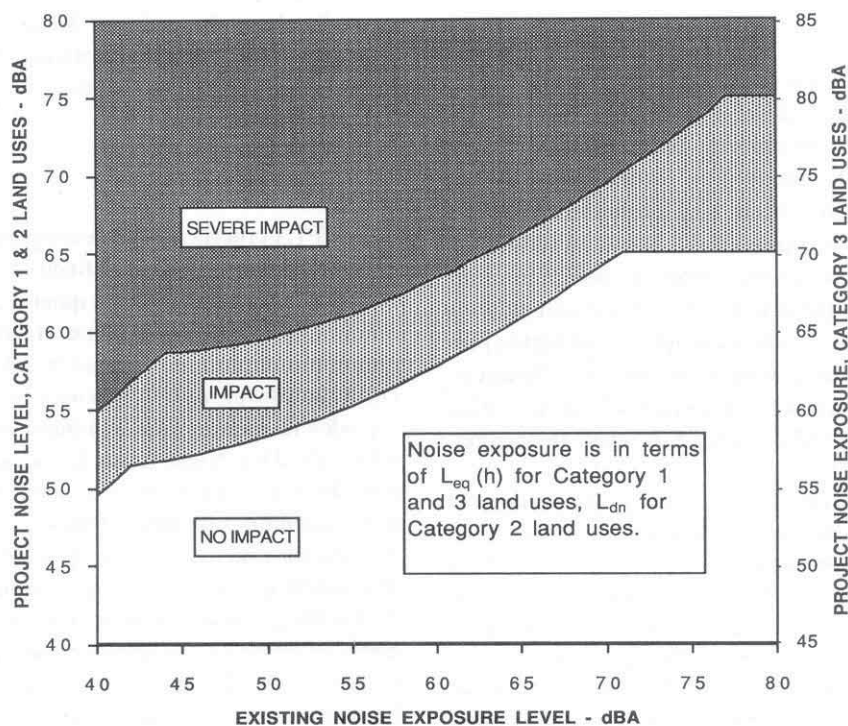

FIGURE 3-1 FTA NOISE IMPACT ASSESSMENT CRITERIA FOR TRANSIT PROJECTS

TABLE 3-7 LAND USE CATEGORIES AND METRICS FOR TRANSIT NOISE AND IMPACT ANALYSIS

Land Use Category	Noise Metric	Description of Land Use Category
1	Outdoor $L_{eq}(h)$	Tracts of land where quiet is an essential element in their intended purpose. This category includes lands set aside for serenity and quiet, and such land uses as outdoor amphitheaters and concert pavilions, as well as National Historic Landmarks with significant outdoor use.
2	Outdoor L_{dn}	Residences and buildings where people normally sleep. This category includes homes, hospitals, and hotels where a nighttime sensitivity to noise is assumed to be of utmost importance.
3	Outdoor $L_{eq}(h)$	Institutional land uses with primarily daytime and evening use. This category includes schools, libraries, and churches where it is important to avoid interference with such activities as speech, meditation and concentration on reading material. Buildings with interior spaces where quiet is important, such as medical offices, conference rooms, recording studios, and concert halls fall into this category. Places for meditation or study associated with cemeteries, monuments, museums. Certain historical sites, parks and recreational facilities are also included.

* L_{eq} for the noisiest hour of transit-related activity during hours of noise sensitivity.

3.3.1.1 Basis

The FTA criteria base the degree of environmental impact in part on existing ambient noise levels. As stated in the guidance manual, they incorporate both absolute criteria, which consider activity interference caused by the transit project alone, and relative criteria, which consider annoyance due to the change in the noise environment caused by the transit project. The level or magnitude of impact is determined by two factors: predicted project noise and existing noise. In the mid-range, the impact criteria allow higher project noise levels as existing noise levels increase. However, there is an absolute limit placed on project noise at the higher ambient levels, as reflected in Figure 3-1, where the ascending curves flatten out.

An important aspect of the FTA noise impact criteria is shown in Figure 3-2. This figure illustrates the cumulative, or total, increase in noise allowed by the impact criteria at different ambient noise levels. As the ambient noise environment gets louder, the increase in cumulative noise allowed by the criteria gets smaller. This aspect recognizes that people already exposed to high ambient noise levels are least able to tolerate increases in noise due to introduction of a new noise source.

As illustrated in Figure 3-2, areas where existing noise levels are low (L_{dn} less than 40 dBA) may suffer a 10 dBA increase in noise level without being described as being significantly impacted by the project. Conversely, areas with a background level on the order of 70 to 75 dBA (e.g., near a highway) may experience a noise increase of only a few decibels by the project and be described as being impacted by the project. A very attractive feature of the FTA criteria is that they help to reduce “incrementalization” of noise impacts due to multiple projects; adding to already excessively high

noise levels on the order of 80 dBA is not necessarily an appropriate approach. Few criteria for environmental assessment have this desirable feature.

3.3.1.2 Land Use Categories

The FTA criteria are defined separately for three different categories of land use, as defined in Table 3-7. Category 1 includes tracts of land where quiet is a basis for use, such as outdoor pavilions or National Historic Landmarks where outdoor interpretation routinely takes place. The hourly equivalent level, L_{eq} (h) applies to these areas. Category 2 includes residences and buildings where people sleep, for which the Day-Night level, L_{dn} , is to be used. Category 3 areas include schools, libraries, churches, certain parks, and other institutions frequented during the daytime and evening periods, for which the hourly equivalent level, L_{eq} (h), applies. The hourly L_{eq} used for Category 1 and 3 areas is the hourly L_{eq} for the noisiest hour of transit related activity during the hours of land use. As indicated in Figure 3-1, the project noise limits for Category 3 areas may be 5 dB higher than the limits for Category 1 and 2 areas.

The criteria do not apply to industrial or commercial areas which are compatible with high noise levels. However, commercial establishments that require quiet as a basis for use would be subject to the criteria, such as motion picture or recording studios. The application of the criteria to historical structures depends on their use and location. Thus, historical structures used as commercial shops in noisy downtown areas would not be subject to the criteria. Historical transportation structures, such as railroad stations, would not be considered noise sensitive, simply on the basis of their use.

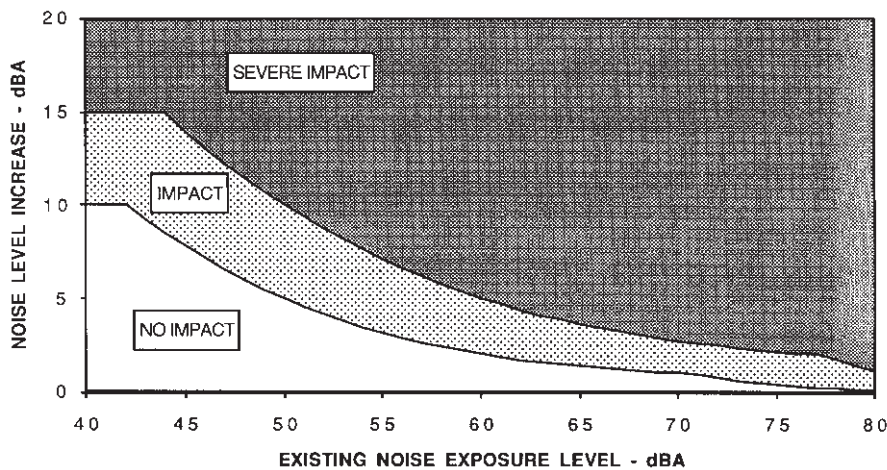

Noise exposure is in terms of L_{eq} (h) for Category 1 land uses, L_{dn} for Category 2 land uses.

FIGURE 3-2 INCREASE IN CUMULATIVE NOISE LEVELS ALLOWED BY FTA CRITERIA FOR LAND USE CATEGORIES 1 AND 2

3.3.1.3 Levels of Impact

The terms “no impact,” “impact,” and “severe impact” may be interpreted as follows:

No Impact. The project, on average, will result in an “insignificant increase in the number of people highly annoyed by new noise.” The term “highly annoyed” is vague, but usually refers to people willing to engage in litigation or, at the very least, complain about the noise to local officials with threat of litigation.

Impact. This is a moderate impact. The change in cumulative noise is noticeable to most people, but may not be sufficient to cause strong, adverse community reactions. Other project-specific factors must be considered to determine the need for mitigation, such as the types and numbers of noise-sensitive land uses.

Severe Impact. A significant percentage of people would be highly annoyed by the noise, perhaps resulting in vigorous community reaction attended by litigation.

Categories 1 and 2 impact criterion curves for “impact” and “severe impact” are constant at project noise levels of 65 and 75 dBA for existing ambient noise levels in excess of 71 and 77 dBA, respectively. Project noise levels greater than 65 dBA or 75 dBA are considered an “impact” or “severe impact,” respectively, regardless of the existing noise level.

The FTA criteria do not apply to most commercial or industrial land uses, unless quiet is a basis for such use. Examples of industries which would fall under the purview of the FTA criteria include sound and motion picture recording studios. A word of caution is appropriate, however. Many motion picture or sound recording studios require very low ambient background sound levels of about 15 dBA to allow use of the facility for modern digital sound mastering. Also, commercial buildings in areas of restricted automobile or truck usage, such as open malls, may be impacted by transit noise.

3.3.1.4 Mitigating Adverse Impact

The FTA noise impact criteria provide a framework for assessing the magnitude of impact from proposed projects. The criteria are based on human response to noise and do not incorporate considerations of feasibility, practicality or cost of reducing adverse noise levels. Once the magnitude of impact has been established during the environmental review process, FTA works in cooperation with the project sponsor to determine the need for noise mitigation. The guidance manual does not establish a requirement to mitigate noise at any specific impact level, although “severe impact” presents the most compelling case to reduce noise. The manual outlines the project-specific factors that must be considered in determining the need for mitigation. Considerations include the number and types of noise-sensitive sites, the level of existing noise and level of increase due to the project, and the

benefits and cost of mitigation treatments. The reader is referred to the guidance manual for a fuller explanation of how mitigation is addressed.

3.4 LOCAL ORDINANCES

Local noise ordinances may restrict rail transit noise levels. Thus, when planning a new transit facility, or responding to complaints from city or county inhabitants, local noise ordinances should be reviewed to determine if any potential conflicts exist. Often, rail transit noise is not considered in developing a noise ordinance, and the result is that rail transit noise might not be compatible with some noise ordinances if strictly interpreted. In such cases, rail transit systems are asked to meet noise standards that are more restrictive than those for automobiles. For this reason, community understanding of the technical problems facing the transit system designer is important, as is recognition by the designer of local standards for peace and quiet.

When transit corridors are located in residential communities, noise levels invariably exceed the usual limits for continuous noise. This is true for most modern types of transportation including automobiles, buses, and rail transit systems. Recognizing the problem, most modern noise ordinances include specific, but separate, limits on motor vehicle traffic noise levels. If rail transit was not considered when an ordinance was prepared, it may be that the train noise is exempt. However, either a modified ordinance may be required that specifically covers rapid transit systems, or a variance may be required. Without special consideration, the transit system might have to comply with unrealistic noise limits.

Way and structure maintenance such as rail grinding can be very noisy. These operations are most often scheduled at night, a period when residential communities are most sensitive to noise, and when local ordinances are most restrictive. The possibility of local noise ordinances being exceeded by transit maintenance work should be checked. This is particularly relevant to the design of effective rail grinding programs for controlling rail corrugation. A mitigating factor in such maintenance work as rail grinding is the reduction of wheel/rail wayside noise, a long-term benefit achieved with possibly a short-term noise impact. In this case, the community should be made aware of the long-term noise reduction benefits of rail grinding, and, as a result, there should be an increase in the community’s acceptance of maintenance-related noise. Even in this case, efforts should be made to control maintenance-related noise to the extent that is practical.

3.5 PREPARATION OF NOISE SPECIFICATIONS

A comprehensive program for control of wheel/rail noise includes the development of criteria and specifications for new facilities and equipment. Documents for virtually all major purchases of rail transit equipment now include specifications for maximum acceptable limits of noise and vibration.

In developing noise specifications or criteria, one must reach compromise between levels that are technically and economically feasible and levels that will minimize the adverse impact of noise on people and structures. An example specifications for transit vehicle procurements is provided in the *Handbook of Urban Rail Noise and Vibration Control* (see Chapter 2 references).

Of particular interest in the specification for transit vehicles is the designation of a minimum sound transmission loss for each of the characteristic sections of the car body, because most interior noise is generated exterior to the vehicle. This is particularly important for vehicles traveling through subways, where wheel/rail noise is the dominant interior noise. Even on at-grade ballast-and-tie track, inadequate floor sound insulation may result in unnecessarily high interior noise levels.

3.6 REFERENCES

1. "Noise and Vibration," *Guidelines and Principles for Design of Rapid Transit Facilities*, Section 2.7, APTA, Washington, D.C. (1979).
 2. Peters, S. "The Prediction of Railway Noise Profiles," *Journal of Sound and Vibration*, Vol. 32, No. 1 (1974) pp. 87-99.
 3. *Information on Levels of Environmental Noise Requisite to Protect Public Health and Welfare with an Adequate Margin of Safety, Final Report* (Commonly referred to as the "Level Document"), 550/9-74-004, U.S. EPA, Washington, D.C. (March 1974).
 4. Byron, M.E. "A Tentative Criterion for Acceptable Noise Levels in Passenger Vehicles," *Journal of Sound and Vibration*, Vol. 48, No. 4 (1976) pp. 525-535.
 5. *Transit Noise and Vibration Impact Assessment*, Harris, Miller, Miller & Hanson, Inc. for the Office of Planning, FTA, U.S.DOT-T-95-16 (April 1995).
-

CHAPTER 4 WHEEL/RAIL NOISE GENERATION

- 4.1 Introduction, 35
- 4.2 Tangent Track Noise, 35
 - 4.2.1 Normal Rolling Noise, 35
 - 4.2.1.1 Characterization of Normal Rolling Noise, 35
 - 4.2.1.2 Rolling Noise Generating Mechanisms, 36
 - 4.2.1.3 Parallel Mechanical Impedance Model, 38
 - 4.2.1.4 Wheel/Rail Roughness, 40
 - 4.2.1.5 Wheel Mechanical Impedance, 40
 - 4.2.1.6 Rail Mechanical Impedance, 41
 - 4.2.1.7 Contact Stiffness, 42
 - 4.2.1.8 Wheel/Rail Conformity, 43
 - 4.2.1.9 Noise Radiation, 43
 - 4.2.1.10 Directivity, 44
 - 4.2.1.11 Attenuation with Distance, 46
 - 4.2.2 Excessive Rolling Noise, 50
 - 4.2.3 Impact Noise from Rail Imperfections, Joints, and Wheel Flats, 50
 - 4.2.3.1 Smooth Irregularity, 50
 - 4.2.3.2 Level and Decreasing Elevation Rail Joints and Wheel Flats, 50
 - 4.2.3.3 Step-Up Rail Joints, 51
 - 4.2.3.4 Summary of Impact Noise, 51
 - 4.2.4 Corrugated Rail Noise, 51
 - 4.2.4.1 Characterization, 51
 - 4.2.4.2 Wheel/Rail Interaction at Corrugated Rail, 52
- 4.3 Curving Noise, 54
 - 4.3.1 Wheel Squeal, 54
 - 4.3.1.1 Causes of Wheel Squeal, 55
 - 4.3.1.2 Lateral Slip Model, 58
 - 4.3.1.3 Loss Factor Due to Stick-Slip, 60
 - 4.3.1.4 Effect of Internal Loss Factor, 61
 - 4.3.1.5 Friction, 61
 - 4.3.2 Wheel/Rail Howl, 63
 - 4.3.2.1 Mechanism of Wheel/Rail Howl, 63
 - 4.3.2.2 Relation to Rail Corrugation, 63
- 4.4 Special Trackwork, 64
- 4.5 References, 64

This page left intentionally blank.

CHAPTER 4

WHEEL/RAIL NOISE GENERATION

4.1 INTRODUCTION

This chapter discusses the basic theory of wheel/rail noise generation for tangent track, curved track, and special trackwork to provide a foundation for making informed decisions concerning treatment. The mechanisms involved are exceedingly complex, and the reader is referred to the literature for more detailed discussions than those provided here.

There have been substantial advances in the theories concerning wheel/rail noise generation during the 1970s and 1980s, and research in the area is continuing, especially with respect to high speed rail. The theory of wheel/rail noise generation, though highly developed, is incomplete. The effect of wheel and rail profiles on wayside noise from tangent track is being studied, but contradictions exist. Wheel squeal theory is also subject to some inconsistency with respect to field experience. In general, however, this fascinating and challenging field of noise control is rich with topics for theoretical and experimental work.

There are several descriptive terms for various types of wheel/rail noise. The terms *rolling noise* and *tangent track noise* are both used here to refer to noise produced by rail and wheel roughness and material heterogeneity. Rolling noise also occurs at curved as well as tangent track. The term *impact noise* refers to noise generated by rail imperfections, joints, and more significantly, special trackwork. Much of tangent track rolling noise at severely worn rail or with flattened wheels may include substantial impact noise due to wheel/rail contact separation. The terms *wheel squeal* and *curving noise* both refer to the noise generated at curves. Curving noise includes both wheel squeal and *wheel/rail howl*, the latter being the less common. While wheel squeal is due to a stick slip phenomenon involving nonlinear interaction of the wheel with the rail, wheel/rail howl, also common at curves, is less clearly defined.

Tangent track rolling noise is considered first, followed by a discussion on curving noise. Finally, the researchers conclude with a short discussion of special trackwork noise.

4.2 TANGENT TRACK NOISE

Tangent track noise is due to wheel and rail roughness, which may include rail corrugation and random surface defects. Tangent track noise is subdivided into (1) normal

rolling noise for smooth ground rail and trued wheels; (2) rolling noise due to excessively roughened rails and wheels; (3) impact noise due to pits and spalls of the rail and wheel running surfaces, wheel flats, and rail joints; and (4) rail corrugation noise. These categories form a basis for discussion of tangent track noise and selection of noise control procedures. The term *wheel/rail roar* is often used to refer to rolling noise of all types, while *roaring rail* has been used to refer to corrugated rail noise.

Tangent track normal and excessive rolling noise are discussed within the context of a linear theory of wheel/rail interaction, relying on rail and wheel roughness as the primary cause. Another cause of wheel/rail noise may be heterogeneity of the rail steel moduli, for which the linear theory presented here may not be entirely adequate. Further, with sufficiently large amplitude roughness, as with severely corrugated rail, or with severely flattened wheels, wheel/rail contact separation may occur, producing impact noise. A separate theory of impact noise is presented after the discussions of normal and excessive noise, and before the discussion of rail corrugation noise.

4.2.1 Normal Rolling Noise

Noise in the absence of wheel and rail imperfections or discontinuities, such as wheel flats, spalls, rail corrugation, joints, and so on is termed *normal rolling noise*. Normal rolling noise is the baseline condition for which most new rail transit systems are designed, and departures therefrom constitute a degradation of condition and performance with respect to noise control. This baseline condition is the state that operating rail transit systems should be striving for or preserving. There is also an important side benefit associated with a quiet system: smooth rolling surfaces produce less vibration of various trackwork and truck components, thus extending life and, possibly, reducing operational costs.

4.2.1.1 Characterization of Normal Rolling Noise

Tangent track rolling noise has a broadband frequency spectrum, often with a broad peak between 250 and 2,000 Hz. At systems with adequate ground rail and trued wheels, traction motor cooling fan and gearbox noise and undercar

aerodynamic noise may contribute significantly to operational noise, and some care must be exercised in identifying the wheel/rail noise component. Representative samples of 1/3-octave band wayside noise produced by a Bay Area Rapid Transit (BART) vehicle at various speeds are presented in Figure 4-1. In this example, traction power equipment produces the peak in the spectrum at 250 Hz. At higher frequencies, wheel/rail noise dominates the spectrum, peaking at about 1,600 Hz. With trued wheels and smooth ground rail on ballast and ties, BART is one of the quietest vehicles in operation at U.S. transit systems.

A whine may also occur because of a periodic grinding pattern in the rail running surface, as evidenced by the peak at about 1,600 Hz in the 80 mph data shown in Figure 4-1. At lower speeds, this peak is reduced in frequency, consistent with a wavelength in the rail of about 3/4 in. long. Without this component, the passby noise would have been less than measured by a few decibels.

The high levels of low-frequency noise below 125 Hz are likely due to aerodynamic sources in view of the relatively large difference between the 60 and 80 mph data in this frequency range. If there is difficulty in distinguishing the wheel/rail noise component from traction power equipment

noise and other under car equipment noise, then wheel/rail noise is probably not excessive, and efforts at noise control might be directed toward traction power equipment (1)

With normal rolling noise, the rail running surface will be free of spalls, checks, pitting, burns, corrugation, or other surface defects, which may not be entirely visible. The wheel and rail provide running surfaces which, under ideal conditions, should have similar characteristics for smoothness and low noise as any anti-friction bearing. From a practical perspective, ideal bearing surfaces are difficult to realize and maintain in track due to lack of lubricant, corrosion and contamination, and dynamic wheel/rail interaction forces.

4.2.1.2 Rolling Noise Generating Mechanisms

Four generating mechanisms have been suggested in the literature as sources of normal rolling noise. These include

- Rail and wheel roughness,
- Parameter variation, or moduli heterogeneity,
- Creep, and
- Aerodynamic noise.

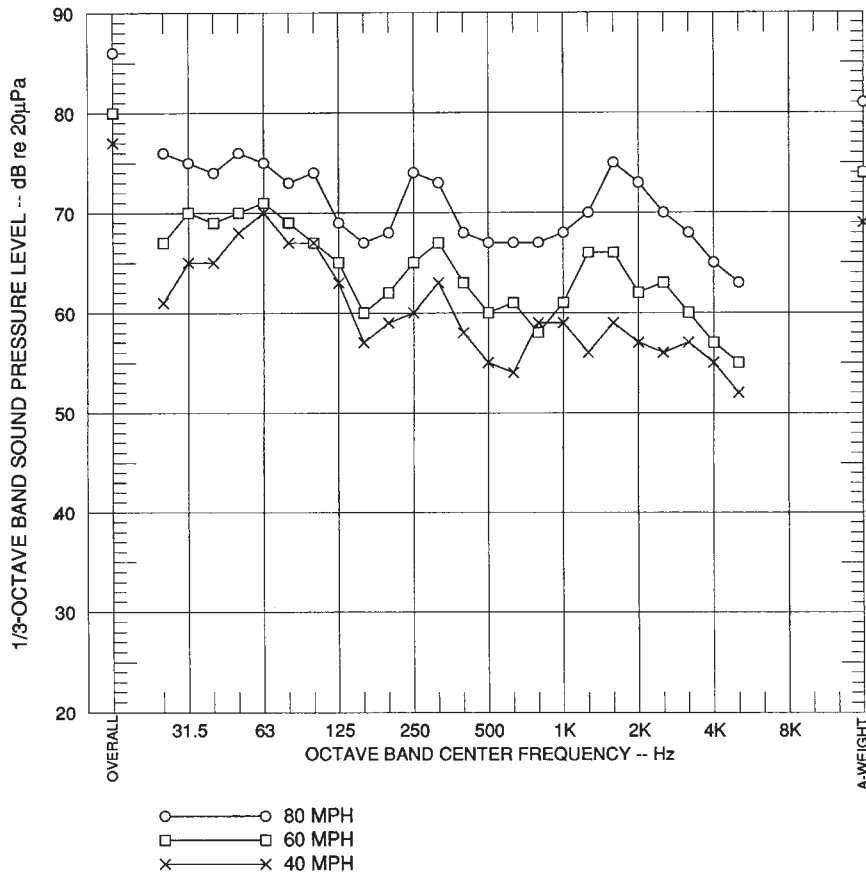

FIGURE 4-1 PASSBY NOISE FOR SINGLE BART VEHICLE WITH ALUMINUM CENTERED WHEELS ON BALLAST AND TIE TRACK

Wheel/Rail Roughness. Wheel and rail surface roughness is believed to be the most significant cause of wheel/rail noise. The surface roughness profile may be decomposed into a continuous spectrum of wavelengths. At wavelengths short relative to the contact patch dimension, the surface roughness is attenuated by averaging of the roughness across the contact patch, an effect which is described as *contact patch filtering*. Thus, fine regular grinding marks of dimensions less than, perhaps, 1/16 in., should not produce significant noise compared to lower frequency components.

Parameter Variation. Parameter variation refers to the variation of rail and wheel steel moduli, rail support stiffness, and contact stiffness due to variation in rail head transverse radius-of-curvature. The influence of fractional changes in elastic moduli and of radius-of-curvature of the rail head as a function of wavelength necessary to generate wheel/rail noise equivalent to that generated by surface roughness is illustrated in Figure 4-2. The wavelength of greatest interest is 1 to 2 in., corresponding to a frequency of about 500 to 1,000 Hz for a vehicle speed of about 60 mph. Over this

range, a variation in modulus of 3% to 10% is required to produce the same noise due to rail roughness. Experimental data for the effect of modulus variation at this frequency have not yet been found. Rail head ball radius heterogeneity also induces a dynamic response in the wheel and rail. The variation of rail head curvature would have to be on the order of 10% to 50% to produce a noise level similar to that produced by rail roughness alone. Data on rail head radii of curvature as a function of wavelength have not been obtained nor correlated with wayside noise. Also, rail head ball radius variation will normally accompany surface roughness, so that distinguishing between ball radius variation and roughness may be difficult in practice.

Dynamic Creep. Dynamic creep may include both *longitudinal* and *lateral dynamic creep, roll-slip* in a direction parallel with the rail, and *spin-creep* of the wheel about a vertical axis normal to the wheel/rail contact area.

Longitudinal creep is not considered significant by some researchers, as rolling noise levels are claimed to not increase significantly during braking or acceleration on

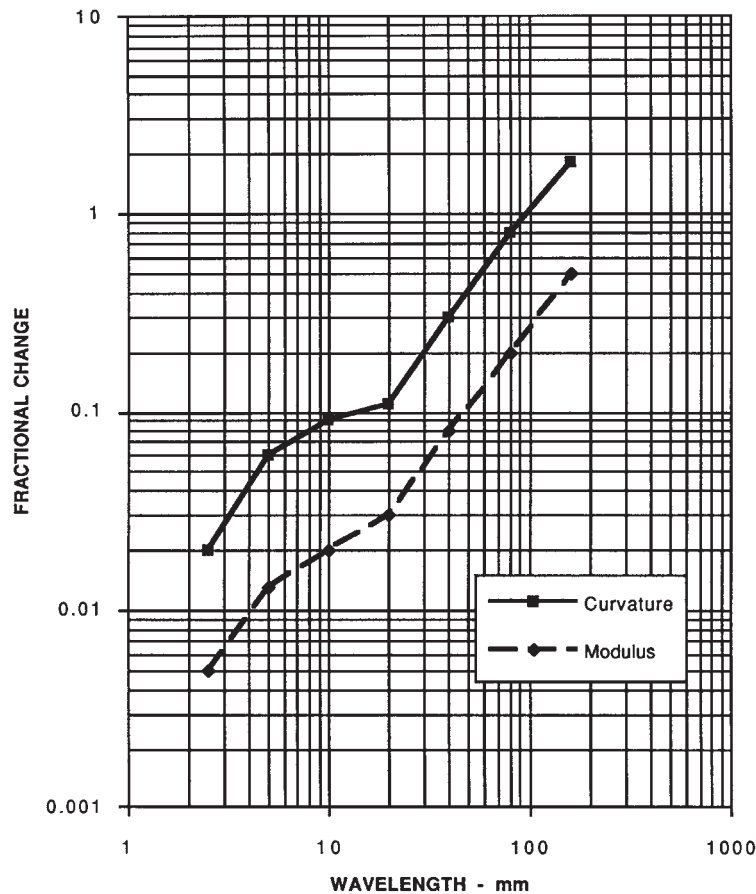

FIGURE 4-2 CHANGE IN ELASTIC MODULUS AND RAIL HEAD CURVATURE REQUIRED TO GENERATE WHEEL/RAIL EXCITATION EQUIVALENT TO ROUGHNESS EXCITATION (5)

smooth ground rail. However, qualitative changes of the sound of wheel/rail noise on newly ground rail with a grinding pattern in the rail running surface is observable to the ear as a train accelerates or decelerates, in contradiction to the notion that longitudinal creep is of no significance.

Lateral creep occurs during curve negotiation, and is responsible for the well-known wheel squeal phenomena resulting from stick-slip. Lateral creep may not be significant at tangent track, but lateral dynamic creep may occur during unloading cycles at high frequencies on abnormally rough or corrugated rail. Lateral dynamic creep is postulated by some to be responsible for short-pitch corrugation at tangent track. Therefore, lateral creep, at least in the broad sense, may be a significant source of noise.

Spin-creep is caused by wheel taper which produces a rolling radius differential between the field and gauge sides of the contact patch. Spin-creep has been suggested as a source of wayside noise at the Vancouver Skytrain (2), though, no data supporting a strong dependence of noise level on spin-creep have been obtained.

Aerodynamic Noise. Aerodynamic noise is caused by turbulent boundary layer noise about the wheel circumference as it moves forward and by undercar components which

exhibit substantial *aerodynamic roughness*. Noise due to air turbulence about the wheel is usually not significant at train speeds representative of transit systems, while noise due to air turbulence in the truck area may be significant. Another interesting possible source is high-velocity jet noise emanating from between the tire and rail running surface, which has been anecdotally suggested as responsible for abnormally high noise levels after rail grinding at Tri-Met, where a grinding pattern was evidently ground into the surface of the rail. However, no measurements have been performed and no theoretical models have been proposed in support of this conjecture.

4.2.1.3 Parallel Mechanical Impedance Model

The standard linear model (3) of wheel/rail rolling noise generation is described in Figure 4-3. The model is a *parallel impedance model* because the vertical mechanical impedance of the rail and wheel appear in parallel with each other, and, together, with the *contact stiffness*, K_c , determine the dynamic interaction forces between the rail and wheel in response to rail and wheel tread roughness. The mechanical impedance is the ratio of contact force to response velocity expressed as a function of frequency.

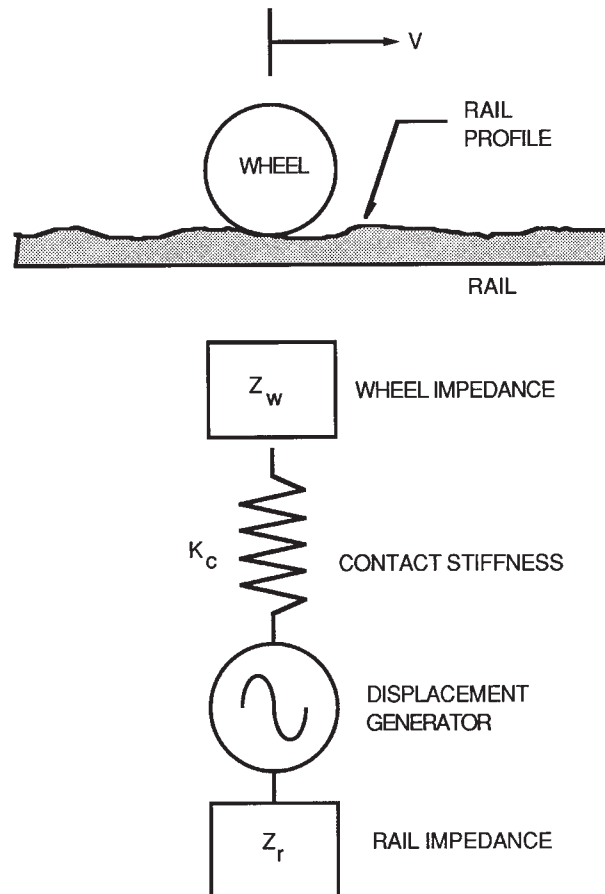

FIGURE 4-3 PARALLEL IMPEDANCE MODEL OF WHEEL RAIL NOISE GENERATION

The roughness is indicated as a displacement generator in series with the contact stiffness. The customary approach is to decompose the rail and wheel roughness amplitude into a spectrum of amplitude versus roughness wavenumber, k , equal to 2π divided by the wavelength, λ . The corresponding frequency, f , of the sound due to roughness is related to vehicle speed, V , and roughness wavenumber as

$$f = kV = 2\pi/\lambda$$

Again, the roughness may be decomposed into an infinity of waves with associated wavelengths, λ . The spectra may consist of discrete wave components, such as with corrugated rail, or may have a continuous spectrum of wave components, as with random roughness.

The model includes the various resonances of the wheel set and track support in the expressions for wheel and rail mechanical impedances. Given the dynamic contact force, the vibration of the wheel may be predicted from the transfer mobilities, or modal velocity responses, of the wheel to contact forces. A modal response is the vibration response of an object at a natural vibration mode, and is associated with a modal, or natural, frequency.

The contact force can be expressed as a function of the parallel combination of the mechanical impedances for the wheel and rail, and the roughness. Thus

$$F(\omega) = \frac{i\omega\delta(\omega)}{\frac{1}{Z_c(\omega)} + \frac{1}{Z_r(\omega)} + \frac{1}{Z_w(\omega)}} = i\omega\delta(\omega)Z(\omega)$$

where i is the square root of -1 , ω is the radian frequency, $2\pi f$, and $Z(\omega)$ is the frequency dependent parallel combination of the impedances.

The contact mechanical impedance, $Z_c(\omega)$, is given by

$$Z_c(\omega) = \frac{K_c}{i\omega}$$

The velocity of the wheel tread at the contact patch, $v_w(\omega)$, and rail head, $v_r(\omega)$, neglecting deformation of the contact patch, are given by

$$v_w(\omega) = \frac{F(\omega)}{Z_w(\omega)} = \frac{Z(\omega)i\omega\delta(\omega)}{Z_w(\omega)}$$

$$v_r(\omega) = \frac{F(\omega)}{Z_r(\omega)} = \frac{i\omega Z(\omega)\delta(\omega)}{Z_r(\omega)}$$

The entire discussion can be reformulated in terms of compliances, $C(\omega)$, through the relation

$$C(\omega) = \frac{1}{i\omega Z(\omega)}$$

In this case, the expressions for the contact force simplify to

$$F(\omega) = \frac{\delta(\omega)}{C_r(\omega) + C_w(\omega) + C_c}$$

The contact compliance, C_c , is assumed to be independent of frequency. The rail and wheel displacements in response to the contact force become

$$\delta_r(\omega) = C_r(\omega)F(\omega)$$

$$\delta_w(\omega) = C_w(\omega)F(\omega)$$

The mechanical impedance functions for the wheel and rail can be rather complicated in the audio range. (See below.) However, the above forms indicate that the ratios of the wheel and rail compliances to the parallel compliance determine the responses of the wheel and rail, respectively. In particular, if the contact stiffness is very large, the parallel impedance becomes the parallel impedance of the wheel and rail, with the contact patch stiffness contributing insignificantly to the interaction. This is the usual condition at frequencies below, perhaps, 100 Hz. If the contact stiffness is sufficiently small, the parallel combination will be controlled by the contact compliance, in which case both the wheel and rail velocities, or displacements, will decrease. If the wheel compliance is high with respect to both the contact and rail compliances, the wheel displacement will approach the combined roughness, $\delta(\omega)$, of the rail and wheel, and the rail displacement will approach zero. Conversely, if the rail compliance becomes very large relative to the wheel compliance, the rail displacement will approach $\delta(\omega)$, and the wheel displacement will decrease.

For normal running noise, where the wheels and rails are in good condition, the above model is expected to be a reasonable representation of the physics of wheel/rail interaction. The model ignores possible contact separation due to excessive roughness or corrugation, which would result in a nonlinear set of equations. Also not included in the model are lateral forces and responses, though these may be included (4). There are no expressions or information concerning lateral rail roughness, and lateral roughness is therefore ignored, though this may not be clearly justified with conical wheels and canted rails. The model also ignores heterogeneity of the rail steel moduli, and other parametric variations such as discrete rail supports with respect to the translating vehicle, and variation of the ball radius of the rail head, which will modulate the contact stiffness. Roll-slip- or spin-creep-generated noise is similarly not included.

Current models of wheel/rail interaction are at a considerably higher state of development than that given above. These more complex models, including the British Rail model of wheel/rail noise generation (TWINS), are discussed by Remington (5) and Thompson (6). A very thorough discussion of high-frequency wheel/rail interaction models is provided by Knothe and Grassie (7).

4.2.1.4 Wheel/Rail Roughness

Examples of measured rail roughness spectra are provided in Figure 4-4. Wheel roughness is equally important, and the roughness, $\delta(\omega)$, appearing in the parallel impedance model should be taken as the square root of the sum of the squares of the two roughnesses. The roughness spectra provided in Figure 4-4 are in terms of 1/3-octave bands of roughness wavenumber, $k = 2\pi/\lambda$, where λ is the wavelength in in. The 1/3 octave band displacement, or roughness, levels are in decibels relative to 1 micro-in. Thus, if one were to “filter” the rail roughness by a 1/3-octave band filter centered at 16 radians per inch, the observed root-mean-square output of the filter would be 24 to 28 dB re 1 micro-in., or about 15 to 25 micro-in. The actual frequency of excitation is obtained by multiplying the wavenumber by the train speed in inches per second and dividing by 2π . Thus, the wavenumber of 16 radians per inch (wavelength equal to 0.393 in.) at a train speed of 60 mph (1,056 in./sec) is 2,690 Hz. These roughness spectra are only representative, and should not be applied to all systems. Actual roughness spectra are expected to vary considerably depending on rail condition, wear, corrugation, and so on.

Employing quantitative estimates of wheel and rail roughness directly in noise prediction and identification of noise control treatments is usually not practical, because of the complexities of the modal responses of the wheel and to a lesser extent the rail, both of which may allow only an approximate estimate of wheel/rail noise. A more useful quantitative approach is to measure wayside or interior noise, and then rely on the model to estimate the qualitative effect of changes in the parameters of the system. Matching roughness spectra to observed wayside noise using an assumed model for noise generation is a practical method of parameter evaluation.

4.2.1.5 Wheel Mechanical Impedance

The calculated radial mechanical impedance of the tread of a resilient wheel is illustrated in Figure 4-5, based on a theoretical formula developed to study the State of the Art Car (SOAC) (8). The anti-resonance of the wheel, indicated by a maximum in the mechanical impedance at about 800 Hz, can be correlated with a peak in the wayside noise spectrum illustrated in Figure 4-6. The wayside noise is of a light

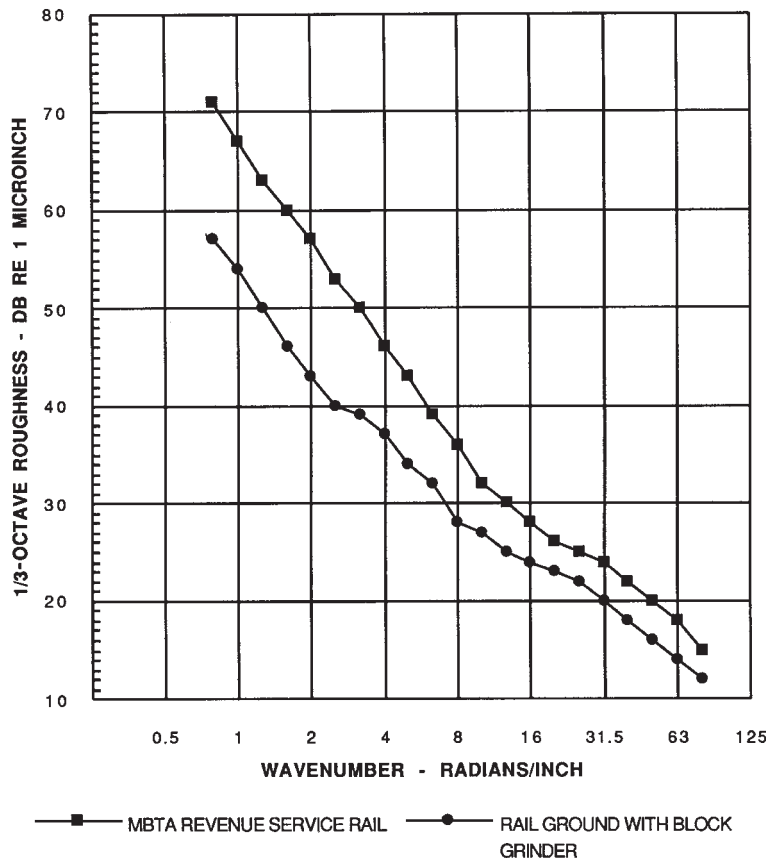

FIGURE 4-4 RAIL ROUGHNESS SPECTRA (5)

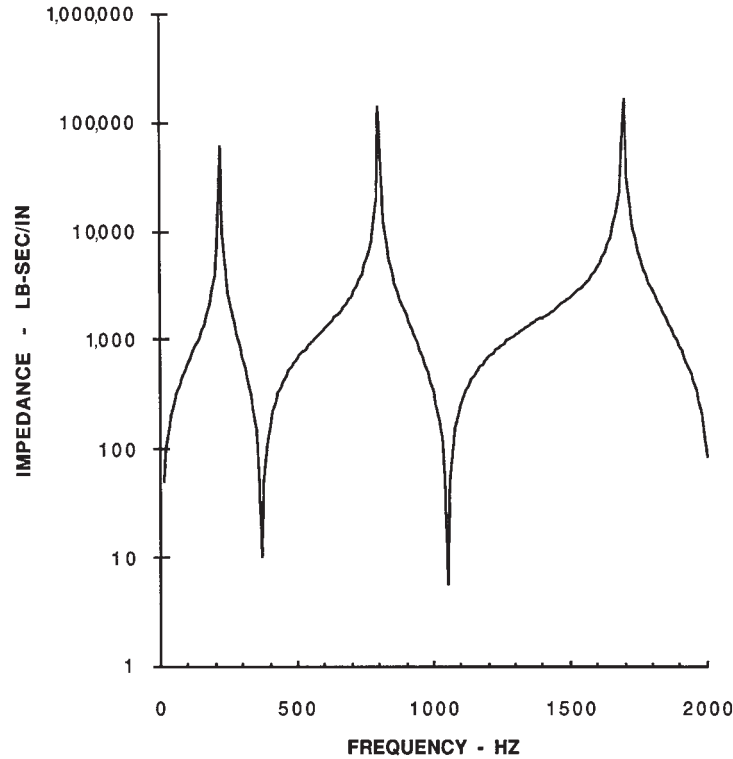

FIGURE 4-5 RADIAL POINT MECHANICAL IMPEDANCE OF WHEEL TREAD (5)

rail articulated vehicle on direct fixation track traveling at about 45 mph at a range of about 150 ft. The sample indicates a dominant peak at about 800 Hz, which contributes to the detectability of train noise in the community. Other mechanical anti-resonances exist at about 200 Hz and at about 1,700 Hz. In general, the mechanical impedance of the wheel is quite complex, and appears to have a strong effect on wayside noise.

4.2.1.6 Rail Mechanical Impedance

The theoretical input mechanical impedance of a 119-lb/yd rail with 150,000 lb/in. stiffness fasteners at 36-in. pitch is illustrated in Figure 4-7 depicting a point on rail head between two adjacent fasteners and another point over a fastener. The fasteners are assumed to have a top plate weight of 14.6 lb, including clips, and the rail is represented by a Bernoulli-Euler beam. The calculation was developed specifically for this manual, and includes the effect of discrete rail supports. The impedance level in dB is 20 Log_{10} (force/velocity in lb-sec/in.). Below 50 Hz, the two impedance functions correspond with that of a spring, while the effect of the rail mass resonating on the fastener stiffness appears between about 100 and 200 Hz, where the imped-

ance approaches a shallow minimum. The rail-on-fastener resonance frequency is calculated to be 110 Hz. However, at higher frequencies, the impedance functions become quite complex. The input mechanical impedance at the rail head between the fasteners exhibits a sharp dip at about 600 Hz due to the pinned-pinned mode resonance of the rail on its discrete supports. The input mechanical impedance directly over a fastener, however, exhibits a poorly developed antiresonant behavior, with rather complicated shape, at the pinned-pinned mode. Both impedance functions exhibit more complicated behavior at higher frequencies. The actual pinned-pinned mode frequency is calculated more accurately by including transverse shear and rotary inertia in the beam equations. (See Chapter 10 for further discussion concerning rail corrugation.)

The 800 Hz component shown in Figure 4-6 can also be correlated with a pinned-pinned mode resonance of the rail at about 700 to 800 Hz, calculated with Timoshenko beam theory for the rail which includes rotary inertia and transverse shear. The calculation is for 115-lb/yd rail with 30-in. fastener spacing. Whether or not the pinned-pinned mode is responsible for the peak in the wayside noise spectrum has not been determined. Another track resonance that may occur in the neighborhood of these frequencies is bending of the fastener top plate. Again, the significance of fastener top plate bending on rail radiated wayside noise has not been

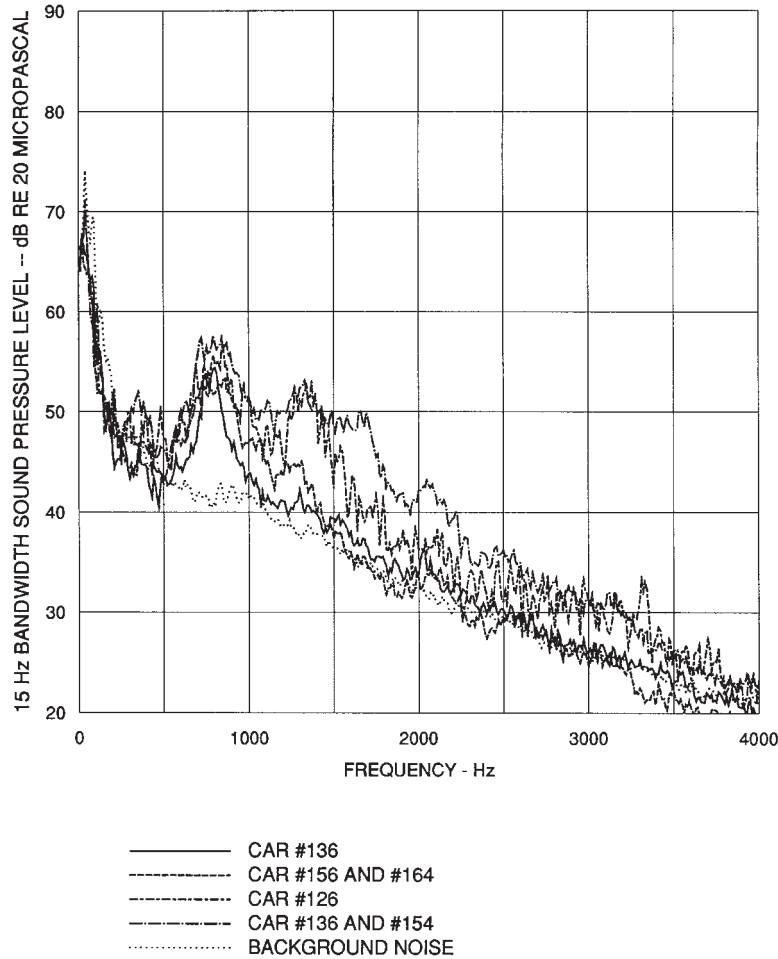

FIGURE 4-6 WAYSIDE NOISE SPECTRA FOR EASTBOUND TRAINS AT 45 MPH ON NEAR TRACK BY 142ND AVENUE

determined. (See the discussion concerning top plate bending in Chapter 10.)

Bending waves will propagate in the rail up to a frequency corresponding to twice the wavelength of the pinned-pinned mode wavelength. Between this wavelength and the pinned-pinned mode wavelength, vibration transmission along the rail may be inhibited, depending on the rail support dynamic characteristics, producing what is termed as the “stop band.” Above the pinned-pinned mode frequency, up to another cut-off frequency, bending waves may propagate freely, resulting in a “pass band.” The response of the rail and its ability to radiate noise will be affected by the widths of the stop band. A slight randomness in the support separation may significantly alter the pass and stop band characteristics (9).

One may conclude that at the dominant frequencies between 250 and 1,000 Hz associated with wheel/rail rolling noise there are extensive possibilities for interaction between the wheel and rail, and that these interactions must be considered when dealing with noise control and rail corrugation.

4.2.1.7 Contact Stiffness

Contact stiffness is calculated on the basis of Hertzian contact theory, the results of which are presented in Figure 4-8 for a 15-in. radius wheel. The contact stiffness does not vary greatly over the range of rail head ball radii, though reducing the ball radius to 6 in. from about 15 in. would appear to reduce the contact stiffness by about 16%, which, under the most optimistic scenario, would reduce contact forces by at most 1.5 dB. Note, however, that contact stresses may be increased as a result of lessened contact area. Optimizing the contact stiffness would not appear to produce a significant noise reduction, while setting the ball radius to be comparable with that of the wheel (15 in.) would “round out” the contact patch, possibly leading to lower wear rates, and, indirectly, lower noise. Typical practice, however, is to employ a ball radius of about 7 to 10 in. As discussed below, wheel tread concavity due to wear increases the lateral contact patch dimension, with the result that the contact width may be comparable with that of a less worn wheel tread on, for

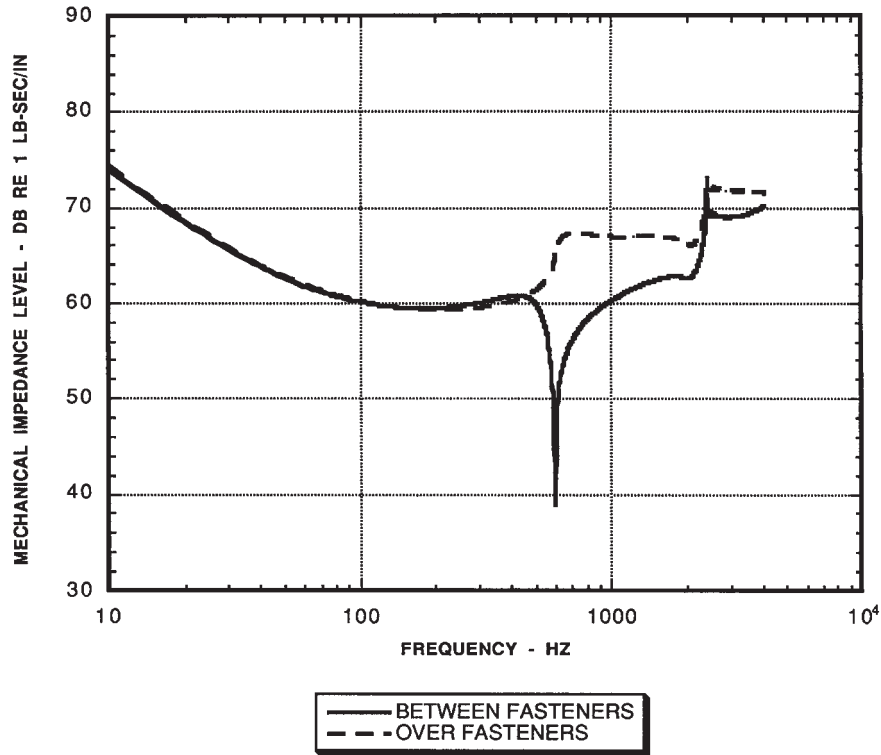

FIGURE 4-7 RAIL INPUT MECHANICAL IMPEDANCE FOR 119 LB/YARD RAIL FASTENER SPACING OF 36 INCHES AND FASTENER STIFFNESS OF 150,000 LB/IN

example, rail with ball radius 14 in. Although the rail head may be optimized for a particular ball radius, wheel tread wear may frustrate maintaining a specific contact width unless a vigorous wheel truing program is in place.

4.2.1.8 Wheel/Rail Conformity

Increasing conformity of the wheel and rail has been proposed by Remington (10) as a noise reduction technique to take advantage of uncorrelated roughnesses between various parallel paths along the rail in the longitudinal direction. Significant noise reductions on the order of 3 to 5 dB are predicted for frequencies on the order of 500 Hz. However, increased wheel/rail conformity has been identified as a cause of spin-creep corrugation at the Vancouver Skytrain (2), leading to noise. Care should be exercised before adopting high conformity wheel and rail profiles. High wheel/rail conformity results from normal wheel tread wear if wheel truing is not frequently conducted.

4.2.1.9 Noise Radiation

Measurement data suggest that both the wheel and rail are significant sources of noise, and both must be considered in developing noise control solutions. The acoustic power radi-

ated by a wheel can be approximated by the area of the wheel multiplied by the rms velocity of the wheel surface in a direction normal to the surface, and the specific impedance of air, ρc , where ρ (1.2 kg/m³) is the air density and c is the velocity of propagation of sound (340 m/sec). Other dimensions are given in SI units as well. Sound radiation by the rail is usually modeled by assuming that the rail is a cylinder of diameter equal to the height of the rail. Noise radiation partitioning between the rail and wheel is difficult to quantify accurately because of the closely coupled nature of the wheel and rail and their proximity to one another. Even the ties can be considered significant noise radiators. For continuous smooth ground rail, much of the theoretical literature suggests that the rail is the most significant radiator of noise (5). Numerous experimental data suggest, however, that wheel-radiated noise is of similar significance as that of the rail (11,12).

Noise radiation from the wheel and rail is described in terms of radiation efficiencies. For a large radiating surface, with dimensions large relative to the wavelength of sound, the radiation efficiency is unity. For a wheel, the radiation efficiency decreases with increasing wavelength above the diameter of the wheel, and, at long wavelengths relative to the diameter of the wheel, the radiation efficiency decreases very rapidly with increasing wavelength. The radiation efficiency for the rail is affected by both the velocity of bending waves in the rail and by the diameter of the rail. The radia-

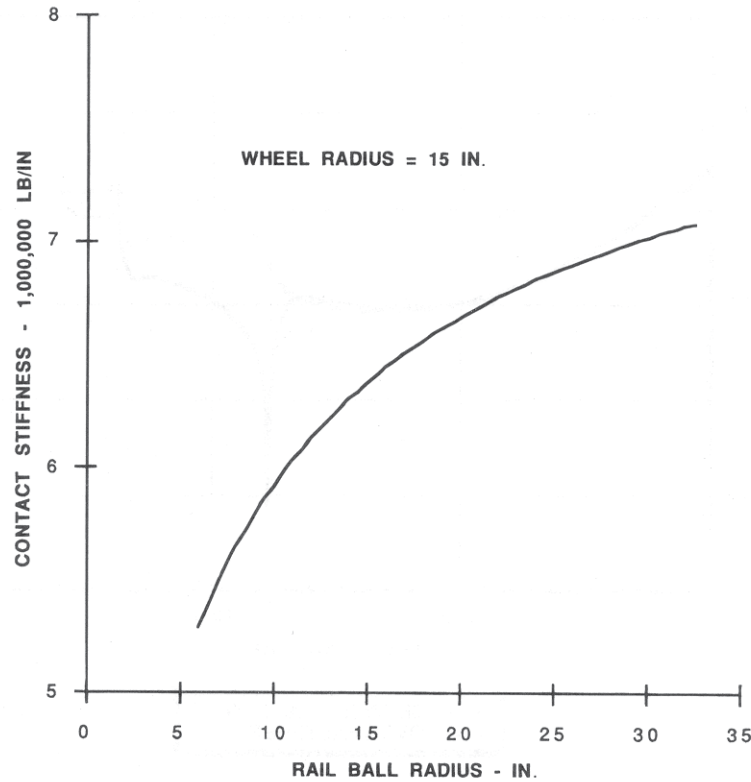

FIGURE 4-8 VARIATION OF CONTACT STIFFNESS WITH RAIL HEAD BALL RADIUS

tion efficiency becomes negligible if the bending wave velocity in the rail is less than the acoustic velocity. For the present purposes, this effect is ignored. The radiation efficiency of a rail may be modeled by a cylinder of diameter equal to the width of the rail. An example of the dependence of the radiation efficiency on frequency for a 6-in.-diameter cylinder in rigid body motion transverse to the rail center is presented in Figure 4-9. This model indicates that the radiation efficiency for a typical rail may be assumed to be unity at frequencies greater than about 1,000 Hz. At lower frequencies, the wavelength in air is long with respect to the diameter of the rail, leading to a declining radiation efficiency with decreasing frequency. However, noise radiation by the rail is still significant at 500 Hz. For very low frequencies, the radiation efficiency is declining as the cube of the frequency and as the fourth power of the rail diameter.

4.2.1.10 Directivity

Peters (12) has determined that the radiation pattern for sound radiated by rail vehicles is primarily that of a distribution of dipole radiators. For a dipole radiator, the sound intensity across a unit of area normal to the direction of propagation varies as the square of the cosine of the angle between the direction of maximum radiation and the direction of radiation

(13). An example of the angular dependence of sound radiation from a dipole source is provided in Figure 4-10. Dipole radiation is consistent with noise radiation from a wheel, and, for this reason, Peters conjectures that the wheel is the dominant radiator of noise. However, much of the noise radiated by the rail may also be radiated in a dipolar fashion.

An example of the passby signature of a 5-car BART transit train is compared in Figure 4-11 with the predicted passby signature based on a dipole radiation pattern (14). The agreement between predicted and measured signature shape is remarkable, indicating that the dipole model is probably most appropriate, though slightly underconservative. The normalized passby signature of a single Portland Tri-Met LRV traveling on ballast-and-tie track at about 35 mph is compared in Figure 4-12 with predictions based on monopole and dipole radiation patterns. In this case, the passby signature falls midway on a decibel scale between that predicted for monopole and dipole sources. The Tri-Met vehicle has Bochum resilient wheels which may affect the radiation of noise. In both cases the dipole model underpredicts the shoulders of the passby signature. From a practical standpoint, the discrepancy is not particularly important for long trains. The data shown for the Tri-Met vehicle are for a single vehicle with three trucks, and may not be representative of the fleet or other light rail vehicles.

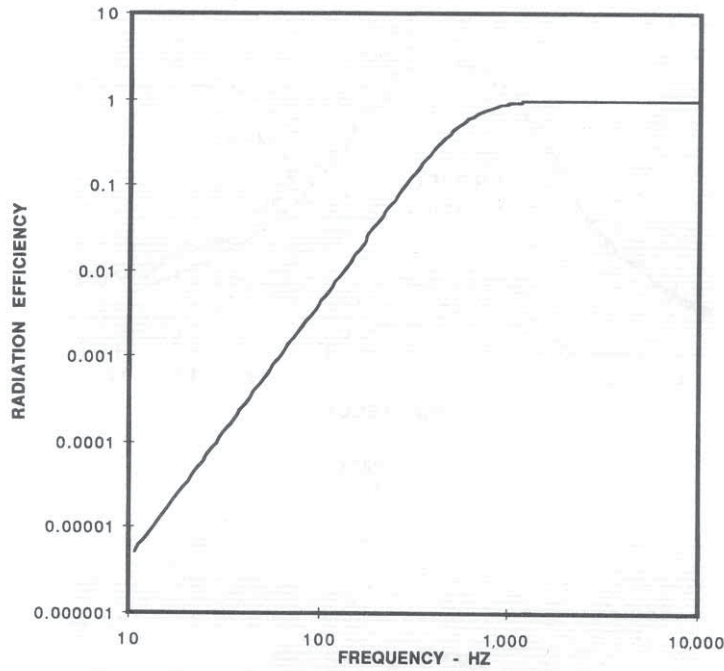

FIGURE 4-9 RADIATION EFFICIENCY OF 6-INCH-DIAMETER CYLINDER IN RIGID BODY TRANSVERSE MOTION

The dipole radiation pattern, or directivity factor, has an effect on computation of energy-averaged sound levels, or noise exposure levels. Maximum sound levels occurring during train passage are not strongly affected, though differences on the order of 1 dB at distances beyond one train length from the track may exist between the dipole and monopole model. The effect on attenuation with distance is not large, but there may be a significant effect when basing

calculations on sound power radiated by the wheels and rails. Finally, if traction power equipment or air conditioning noise is included, the monopole radiation model may become more significant. Assuming a monopole source characteristic will result in a conservative estimate of energy-averaged sound levels such as the Equivalent Sound Level (L_{eq}) or Day-Night Sound Level (L_{dn}), though the margin is limited to 1 dB.

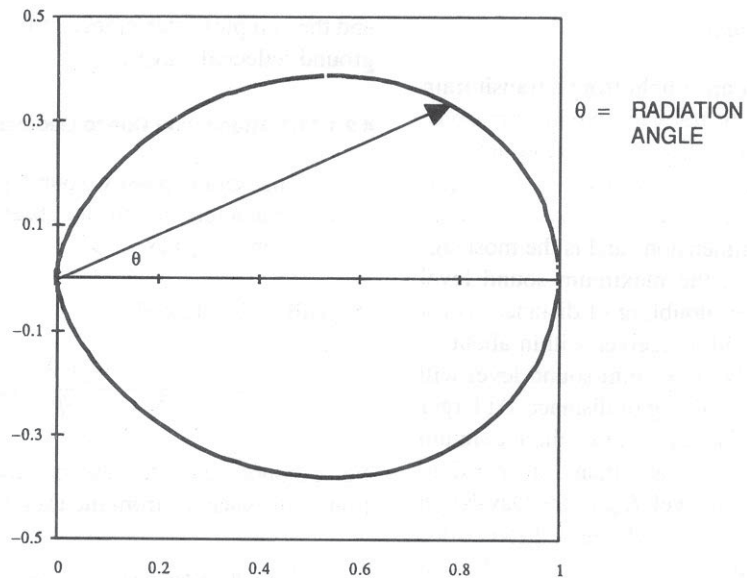

FIGURE 4-10 DIPOLE RADIATION PATTERN

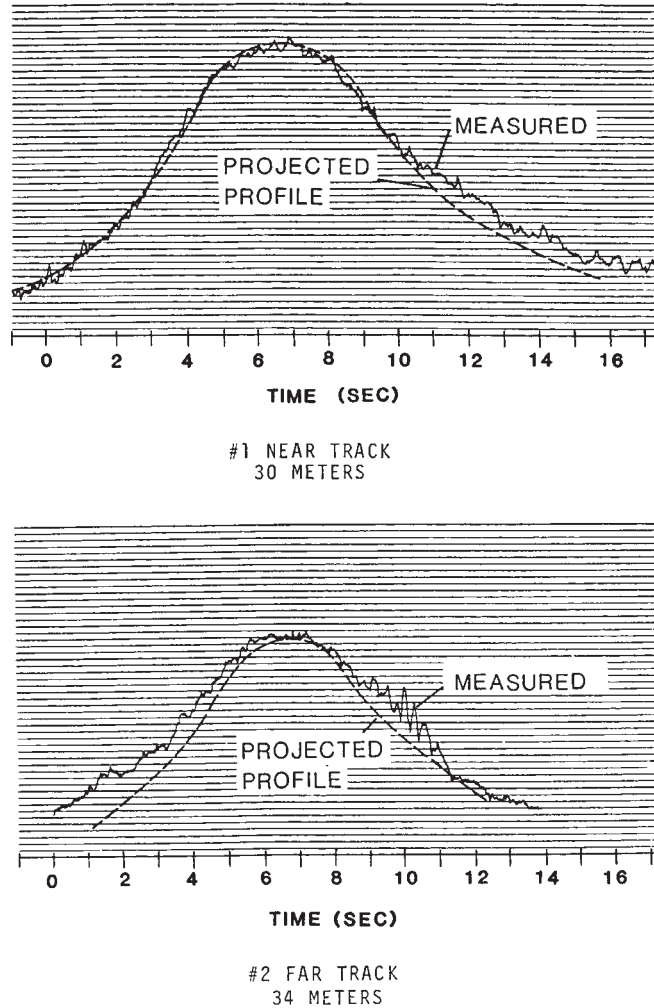

FIGURE 4-11 MEASURED AND PREDICTED PASSBY TIME HISTORY OF A-WEIGHTED SOUND LEVEL FOR 5-CAR BART TRAIN AT 110 KM/HR (70 MPH)

4.2.1.11 Attenuation with Distance

The sound radiated over an open field from a transit train attenuates with distance from the track for two main reasons, the effects of ground and atmospheric absorption notwithstanding: *Geometric Attenuation* or *Spreading Loss*, and *Excess Attenuation*. Geometric spreading loss is due to energy dispersion into three dimensions and is the most significant. From a point source, the maximum sound level attenuates at a rate of 6 dB per doubling of distance. For a line source, such as a train, and a receiver within about 1/2 train length from the track, the maximum sound level will attenuate at a rate of 3 dB per doubling of distance. At larger distances, the finite length of the train causes the maximum sound level to attenuate at a rate greater than 3 dB per doubling of distance. The equivalent level, L_{eq} , or the Day-Night Level, L_{dn} , will attenuate at 3 dB per doubling of distance due to geometric spreading, regardless of train length. Excess attenuation is due to sound energy absorption by the ground

and the complex interference effects related to the direct and ground reflected waves.

4.2.1.11.1 Attenuation Due to Geometric Spreading

The maximum passby sound pressure level for dipole source characteristics in the absence of excess attenuation can be represented as

$$L_{max} \text{ (dB re } 20 \text{ }\mu\text{Pascal)} = 10\text{Log} \left[\frac{3}{4} \frac{\rho c Q_D W'_D}{4\pi R} \{2\alpha + \sin(2\alpha)\} \right] + 94$$

For a monopole source, the maximum sound level as a function of distance, R , from the train is

$$L_{max} \text{ (dB re } 20 \text{ }\mu\text{Pascal)} = 10\text{Log} \left[\frac{\rho c Q_M W'_M}{4\pi R} 2\alpha \right] + 94$$

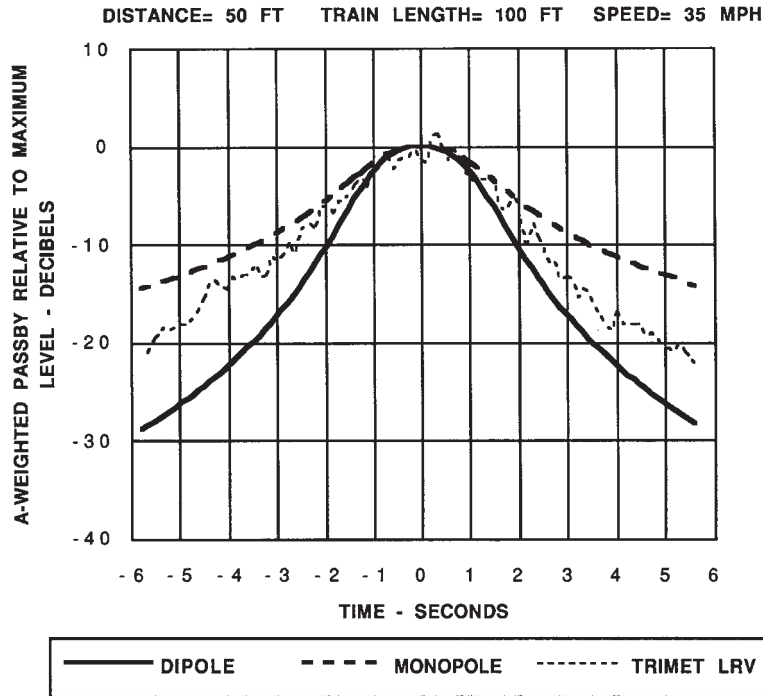

FIGURE 4-12 TRIMET LRV PASSBY SIGNATURE WITH DIPOLE AND MONOPOLE PREDICTIONS

The angle, α , is given by

$$\alpha = \arctan\left(\frac{L}{2R}\right)$$

W'_D is the dipole sound power per unit train length, W'_M is the monopole sound power per unit train length, both in Watts per meter, L is the train length in meters, and R is the distance from the track center in meters. The product of the density and acoustic velocity, ρc , is the specific impedance of air, equal to 407 rayls ($\text{kg}/\text{m}^2/\text{sec}$). (The SI system of units is preferred for these types of computations.) Q_M and Q_D are directivity factors associated with radiation patterns in the vertical plane transverse to the rail. For practical problems, the directivity factors Q_M and Q_D can be assumed to be uniform with respect to the angle above the horizontal plane, though this assumption is open to further investigation. The directivity factors are 1 for a fully absorptive ground surface (ballasted track with grassy embankment), and 2 to 4 for a fully reflective ground plane (embedded track), ignoring interference effects. If most of the noise is radiated by the rail, then Q would be 4 for a concrete invert with direct fixation fasteners, yet 1 for ballast-and-tie track, a not insignificant difference of 6 dB, and only slightly greater than the 5 dB difference often observed between noise levels from aerial structure and ballasted track.

In practice, the sound level is measured at a reference distance of, perhaps, 15 m, or 50 ft, and sound levels at other

distances are expressed as ratios of distances, speeds, and so on. In this case, the acoustic impedance, ρc , and the sound power per unit track length cancel each other out. A variant of this approach is to measure the single-event noise exposure level, SENEL, or simply the SEL, for a train, and, from that, determine the sound power per unit length of train, assuming either a dipole or monopole distribution of sources. The SEL for a train passby is 10 times the logarithm of the time integral of the sound pressure squared, relative to the square of the reference pressure. For dipolar noise characteristics, the SEL is

$$\text{SEL (dB)} = 10\text{Log}_{10} \left[\int_{-\infty}^{+\infty} \frac{p^2(t)}{p_0^2} dt \right] = 10\text{Log}_{10} \left[\frac{3}{4} \frac{\rho c Q W'_D L}{p_0^2 4 R v} \right]$$

The integral is with respect to time in seconds and v is the train speed in m/sec. For a monopole source, the SEL is

$$\text{SEL (dB)} = 10\text{Log}_{10} \left[\frac{\rho c Q W'_M L}{p_0^2 4 R v} \right]$$

The total sound power for the train is WL . A factor of $3/4$ appears in the expression for the dipole source. Thus, the single event level, SEL, for a dipole source is 1.25 dB less than the SEL for a monopole source of equivalent sound power per unit length.

The maximum sound level can be expressed in terms of the SEL directly, given the train length and distance (15). For the dipole distribution, the expression is

$$L_{\max}(\text{dB re } 20 \mu Pa) = \text{SEL} + 10\text{Log}_{10}\left[\frac{V}{\pi L}\right] + 10\text{Log}_{10}[2\alpha + \sin(2\alpha)]$$

For the monopole source distribution

$$L_{\max}(\text{dB re } 20 \mu Pa) = \text{SEL} + 10\text{Log}_{10}\left[\frac{V}{\pi L}\right] + 10\text{Log}_{10}[2\alpha]$$

The maximum sound level may be expressed in terms of the reference SELs presented in the FTA guidance manual for environmental assessment (16). The reference SEL levels are referenced to 50 ft from track center and 50 mph train speed. Dipole source distributions are assumed for rail cars, assuming that the noise is primarily wheel/rail, for which the maximum levels are then given by

$$L_{\max}(\text{dB re } 20 \mu Pa) = \text{SEL}_{\text{ref}} + 10\text{Log}_{10}\left[\frac{S(\text{mph})}{50(\text{mph})}\right] - 10\text{Log}_{10}\left[\frac{L(\text{ft})}{50 \text{ ft}}\right] + 10\text{Log}_{10}[2\alpha + \sin(2\alpha)] - 3.3$$

For the monopole distribution, the maximum level is

$$L_{\max}(\text{dB re } 20 \mu Pa) = \text{SEL}_{\text{ref}} + 10\text{Log}_{10}\left[\frac{S(\text{mph})}{50(\text{mph})}\right] - 10\text{Log}_{10}\left[\frac{L(\text{ft})}{50 \text{ ft}}\right] + 10\text{Log}_{10}[2\alpha] - 3.3$$

For train length long relative to receiver distance, α approaches $\pi/2$, $\sin(2\alpha)$ approaches 0, and the expressions for the maximum passby levels in terms of the SELs become the same for the dipole and monopole sources.

The attenuation of wayside maximum noise levels as a function of distance from a train with dipole noise sources is illustrated in Figure 4-13 (17). At distances close to the train,

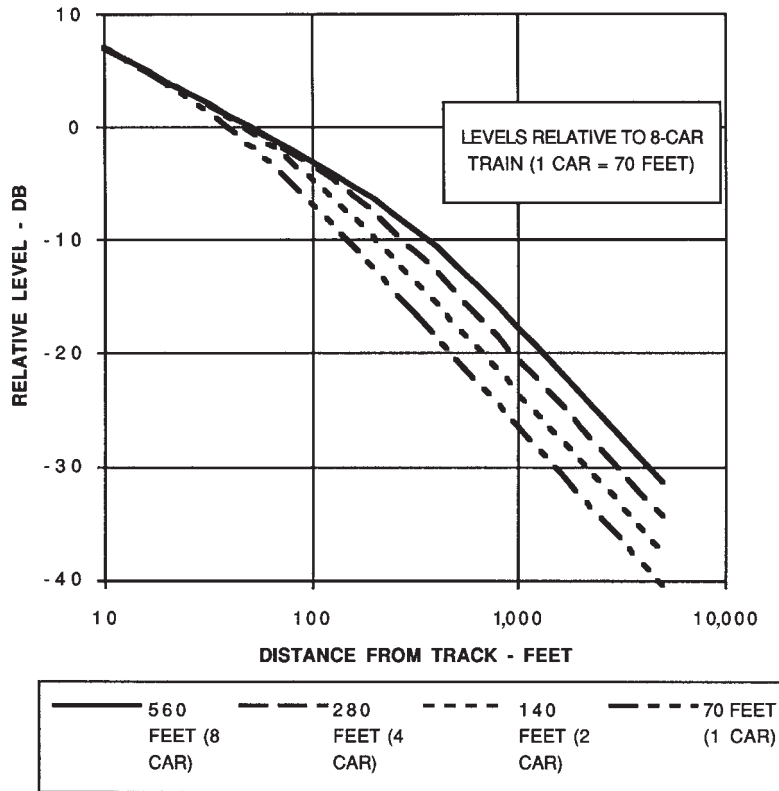

FIGURE 4-13 GEOMETRIC SPREADING FACTOR FOR TRANSIT TRAINS (LEVELS ARE IN DECIBELS RELATIVE TO AN 8-CAR TRAIN AT 50 FEET - A CAR IS ASSUMED TO BE 70 FEET LONG)

that is, within one train length, the attenuation versus distance is about 3 dB per doubling of distance, corresponding to a line source. At larger distances, the train begins to look like a point source, or at least a source of finite length, and the attenuation due to geometric spreading increases to about 6 dB per doubling of distance. The distance at which the attenuation versus distance goes from a line source character to a point source character is determined by whether or not the train is modeled as a dipole or monopole source. Within a distance of $2/\pi$ times the average truck-to-truck spacing, the short-period maximum noise level will be controlled by individual trucks, and the attenuation versus distance curves given in Figure 4–13 will not be representative at distances less than about 15 to 25 ft from the track. Normal train/receiver distances are greater than 25 ft, though there exist urban situations with transit structures immediately adjacent to residential structures.

The calculation of energy equivalent sound levels (L_{eq}) as a function of distance will depend on source characteristics, train speed, length, and so on. The SEL, L_{eq} , and L_{dn} attenuate at a rate of 3 dB per doubling of distance in the absence of ground effects, shielding by structures, or atmospheric absorption, because of the linear nature of the source when averaged over time. This particularly simple result leads to great simplification in predicting transit system noise, as opposed to predicting the attenuation with distance of maximum sound levels.

4.2.1.11.2 Excess Attenuation

Where ground effects are to be included, a common assumption is that the single-event sound exposure level, SEL, or equivalent level, L_{dn} , attenuate at a rate of 4.5 dB per doubling of distance from the track. In this case, the maximum sound level may be calculated from the SEL using the formulas given above for 3 dB per doubling of distance to within an accuracy of about $1/2$ dB. This surprising result is due to the fact that the maximum level will also decline by about 1.5 dB per doubling of distance in addition to the geometric spreading loss. More refined estimates of ground effect are provided in the FTA Guidance Manual (18).

The sound power per unit length cannot be reliably estimated from maximum sound levels and assuming a 4.5 dB attenuation per doubling of distance. A more physically realistic model would be required. On the other hand, within 50 ft from the track, sound absorption provided by the ground may not be significant, and a 3 dB attenuation per doubling of distance would probably be appropriate for most close receivers. In fact, with respect to design of noise control treatments, relying on excess attenuation to control noise impacts at receivers within about 100 ft from the track is probably not appropriate, since most receiver windows are well above the ground, and second story windows would not benefit at all. This is doubly true for aerial structure track.

Judgment must be exercised in determining whether to include excess attenuation.

Atmospheric absorption is usually not significant within about 500 to 1,000 ft of the source. The excess attenuation at a frequency of 500 Hz and at a distance of 1,000 ft from the source is less than a decibel. Noise from rail transit systems is usually insignificant beyond about 500 ft from the track. For this reason, atmospheric absorption is not included in the modeling of rail transit noise versus distance. However, there may exist certain pathological situations where noise complaints are received from residents located at considerable distance from the track. Examples include low-frequency noise radiation from bridge structures, for which atmospheric absorption is not significant again. Rail corrugation may cause particularly raucous noise which may be objectionable to receivers at distances in excess of 500 or 1,000 Hz, depending on the type of community. In these cases, atmospheric absorption should be included in the consideration of sound propagation. However, one must add the effects of temperature inversions and wind gradients, both of which are discussed in the preceding chapter.

4.2.1.11.3 Combined Geometric Spreading and Excess Attenuation

The following formula can be used to compute the SEL at a receiver for a reference SEL_{ref} given for a reference distance and speed.

$$\text{SEL} = \text{SEL}_{\text{ref}} + (K_{\text{speed}} - 10) \text{Log}_{10} \left(\frac{V}{V_{\text{ref}}} \right) - (1 + G) 10 \text{Log}_{\text{ref}} \left(\frac{D}{D_{\text{ref}}} \right)$$

$$K_{\text{speed}} = 30 \text{ dB/Decade speed}$$

$$G = 0.5 \text{ (Soft Ground)}$$

$$= 0 \text{ (Hard Ground)}$$

The speed dependence, K_{speed} , is given as 30 dB per decade speed for the maximum sound level, which is reasonably accurate for wheel/rail noise calculations. In the above, a decade change in speed is an increase in speed by a factor of ten. Thus, A-weighted noise levels will tend to increase approximately as $30 \text{ Log}_{10}(\text{speed})$. Ten decibels are subtracted to account for the vehicle passby time duration, so that the actual variation of SEL as a function of train speed would be about 20 dB per decade speed. A lower speed dependence of 27 dB per decade speed has been measured for passby maximum sound levels by the author for vehicles with Bochum wheels. Still lower speed dependence might be

obtained for vehicles with minor wheel flats, due to the speed dependence of wheel flat noise on train speed, as discussed below. The excess attenuation factor, G , is 0.5 if 4.5 dB attenuation per doubling of distance is assumed for “soft” ground, and is identically zero if a 3 dB attenuation per doubling of distance over “hard” ground or from aerial structures is assumed. This usage is consistent with the FTA Guidance Manual.

4.2.2 Excessive Rolling Noise

Excessive rolling noise without corrugation is produced by abnormally rough rails and wheels. The roughness may or may not be apparent to the eye, and may include visible pits, spalls, and other imperfections in the running surface. Poor definition of the contact wear strip or irregular width contributes to excessive rolling noise. The rail roughness spectrum illustrated in Figure 4–4 for the MBTA is an example of rough rail. Where excessive rolling noise is suspected, an inspection of the track and wheels may indicate pits and spalls and generally worn running surfaces. A quantitative measurement of rail roughness using a profilometer can be used to measure the roughness amplitude as a function of wavelength or wavenumber. Noise reductions achieved by rail grinding would confirm the existence of excessively rough rail.

Excessive rolling noise due to rail and wheel roughness with insufficient amplitude to produce contact separation is describable by the standard linear model of parallel mechanical impedances described above. In this case, the excessive rolling noise level varies linearly with roughness level. If smooth undulations of the rail surface are of sufficient amplitude, contact separation may occur, contributing to visible wear. In these cases, impact noise may occur, which is discussed below in the next section.

The radiation and attenuation with distance of noise as described above for normal rolling noise also applies to excessive rolling noise. The noise radiation should conform to that of a distribution of dipole sources.

4.2.3 Impact Noise from Rail Imperfections, Joints, and Wheel Flats

Impact noise is a special type of wheel/rail noise which occurs at tangent track with high-amplitude roughness, rail joints, rail defects, or other discontinuities in the rail running surface, and wheel flats. Remington provides a summary of impact noise generation (5), which involves nonlinear wheel/rail interaction due to contact separation, and is closely related to impact noise generation theory at special trackwork. I. L. Ver (19) categorizes impact noise by type of rail irregularity, train direction, and speed. The theory presented below is based on Ver’s discussion.

4.2.3.1 Smooth Irregularity

A smooth irregularity may produce an impact if the train speed exceeds the critical velocity defined as

$$V_{CE} = \left[\frac{g \left(1 + \frac{M}{m} \right)}{d^2 y/dx^2} \left(1 + \frac{m \beta}{\rho} \frac{\beta}{2} \right) \right]^{1/2}$$

Here, g is the acceleration of gravity, M is the total vehicle weight supported by the wheel, m is the wheel mass, ρ is the rail mass per unit length, and y is the rail longitudinal profile. The parameter, β , is related to the rail support modulus, and rail section by

$$\beta = \left[\frac{\mu}{4EI} \right]^{1/4}$$

*The rail need not contain a visual discontinuity to produce an impact, because even a smooth undulation in the rail profile may cause contact separation. For an 880-lb wheel, 100 lb/yd rail, rail support modulus of 8.5×10^5 lb/ft², and roughness wavelength of 1.3 ft and amplitude of 0.08 in., the critical velocity at which rail separation may be expected is about 60 mph. The critical velocity is about 30 mph for a short wavelength of perhaps 2 in. and amplitude 0.05 in. (corresponding to very severe short pitch rail corrugation). (Impact theory is directly relevant to contact separation at corrugated rail.) The theory suggests that contact separation will occur at lower train speeds for low wheel loads than for high wheel loads. Thus, *light weight transit vehicles are more prone to dynamic contact unloading, lateral slip, and, perhaps, short pitch corrugation, than heavy freight vehicles.**

4.2.3.2 Level and Decreasing Elevation Rail Joints and Wheel Flats

“Level rail” joints are characterized by rail ends at equal running surface elevation, but separated by a distance, w . A decreasing elevation, or “step-down” joint, is characterized by an elevation drop, h . Wheel flats are characterized by the same distance, h , which is the defect depth of the flat relative to the normal rolling surface of the wheel. A rolling wheel must traverse the gap or wheel flat, and there exists a critical velocity above which the wheel loses contact with the rail. In this case, the critical velocity is given by

$$V_{CE} = \left[ag \left(1 + \frac{M}{m} \right) \left(1 + \frac{m \beta}{\rho} \frac{\beta}{2} \right) \right]^{1/2}$$

where a is the wheel radius. The gap width, step-down height, or flat depth do not significantly affect the critical velocity, though these parameters do strongly determine the impact velocity of the rail and wheel, which is directly related to the peak sound pressure produced by the impact.

At high speed, the noise produced by a wheel flat will decrease with increasing train speed, and, at sufficiently high speed, the noise due to a relatively small single flat may become imperceptible above the normal rolling noise. Even with large flats, the wheel will appear to drop on the flat at low speed, but not drop on the flat at high speed (20). Similarly, a wheel traversing a gap will produce less noise at sufficiently high speed than at lower speeds.

4.2.3.3 Step-Up Rail Joints

Step-up rail joints are the most serious of impact noise producing rail joints, because there is no critical speed above which the peak sound pressure ceases to rise with increasing speed. An impact is always generated, and the impact velocity is directly related to speed. As a result, the impact noise from step-up joints would never be masked by normal rolling noise as might occur for step-down joints or wheel flats. The rail impulse, $m_{eq}\Delta V$, is then given by

$$m_{eq}\Delta V = Vm_{eq}\sqrt{\frac{2h}{a}}$$

where m_{eq} is an equivalent rail mass determined by its bending stiffness and mass per unit length. For typical rail supports and bending moduli, the equivalent mass is approximately 40% of the mass contained within a 1-m-long section of rail.

4.2.3.4 Summary of Impact Noise

The main points of the above discussion are listed by I. L. Ver, et al. as

- 1) The step-up joint is the most serious rail joint with respect to producing impact noise, because there is no critical speed above which no increase in noise level may be expected with increasing speed.
- 2) Step-down joints and wheel flats cause separation of the wheel from the rail above a critical velocity. Below the critical velocity, sound pressure levels may be expected to increase with increasing train speed. Above the critical velocity, no increase in noise level may be expected with increasing train speed, and the impact noise may be masked by rolling noise at sufficiently high speed.
- 3) Below critical speed, step-up joints, step-down joints, and wheel flats of the same height generate similar peak sound levels for a given rail head elevation difference or flat depth, h . The peak sound pressure increases with increasing wheel load and height.
- 4) Smooth irregularities may produce impact noise due to contact separation above a critical speed. The critical speed is less at lower axle loads than at higher axle loads, and increases with increasing radius of curvature of the irregularity.

- 5) Rail support resilience increases the critical speed relative to rigid rail condition. For typical wheels and rail support conditions, the increase is by a factor of two relative to rigid track.
- 6) The impact noise *decreases* with increasing wheel radius and *increases* with increasing wheel mass. These offsetting parameters may cancel any noise reduction which might be expected by increasing wheel radius.

Modern transit systems employing continuous welded rail and trued wheels will likely not be concerned with impact noise generated by rail joints, though there will remain impact noise generated by rough rail, wheel flats, switch frogs, and crossover diamonds. Further, older systems which employ jointed rail at steel elevated structures must be concerned with rail joint condition and maintenance, and all systems must be concerned with rail grinding and wheel truing to eliminate associated impact noise.

4.2.4 Corrugated Rail Noise

Rail corrugation causes excessive rolling noise of a particularly harsh character and of very high level. The terms “roaring rail” or “wheel howl” or “wheel/rail howl” are typical descriptors of noise produced by corrugated rail.

4.2.4.1 Characterization

If rail corrugation exists, the passby noise level will be high compared to that of normal rolling noise, and the spectrum will contain discrete frequency components and associated harmonics clearly revealed with 1/3-octave or narrow band analyses of the passby or interior noise. An example of a 1/3-octave band spectrum of noise due to trains traveling on corrugated direct fixation track is presented in Figure 4–14. In this case, the existence of corrugation is revealed by the spectral peak at the corrugation frequency, which occurs at about 500 Hz. A second harmonic is also visible at 1,000 Hz. In this example, the trains had aluminum centered wheels, and were typically four to seven cars in length. Also, at this location, train speeds were uniform at about 54 mph, regulated under computer control. Thus, the corrugation wavelength was clearly defined, not being destroyed by random train speed variation.

Narrow band analyses of noise may reveal corrugation wavelengths or other periodic patterns in the rail running surface. For example, noise collected at multiple train speeds for operation on the same corrugated rail will show a linear variation of spectral peak frequencies with train speed. At high speeds, contact separation might occur, and the discrete frequency component due to rail corrugation may broaden, for which a less easily identified pure tone component might be expected. Narrowband analyses of car interior noise with substantial wheel/rail howl are presented in Figures 4–15 and

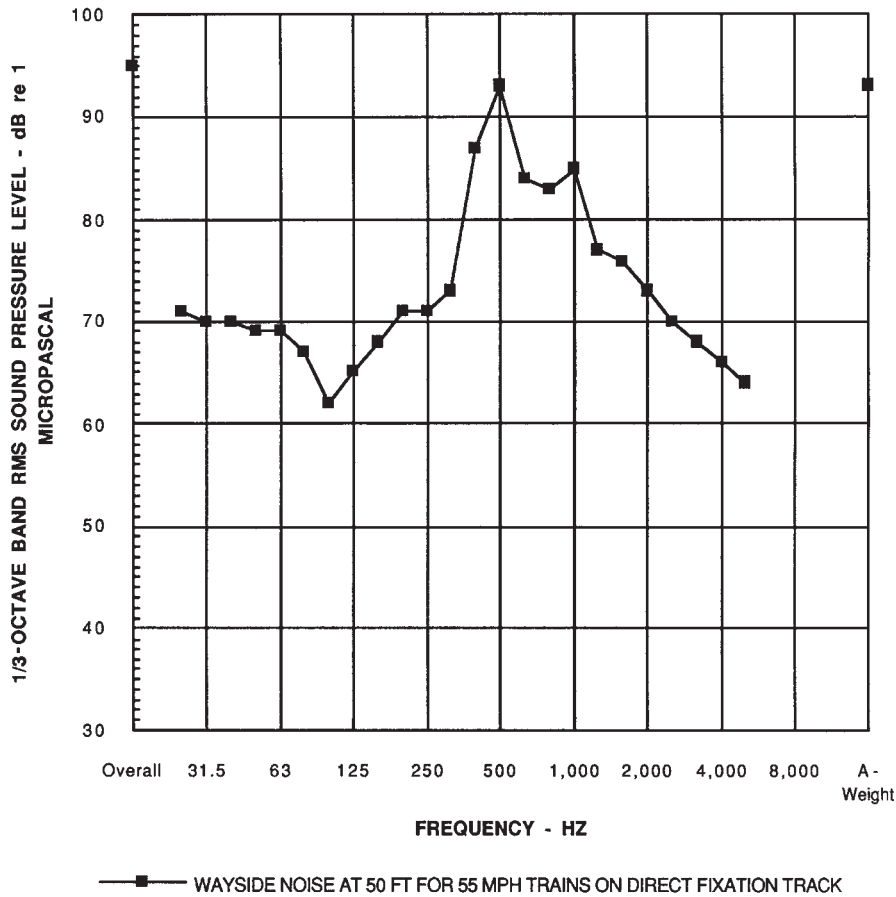

FIGURE 4-14 ONE-THIRD OCTAVE SPECTRUM OF NOISE DUE TO RAIL CORRUGATION

4–16 for train speeds 40 and 66 mph, respectively. The data were recorded at a severely corrugated section of track and at a section of recently ground track with grinding pattern in the BART transbay tube. The corrugation frequency is clearly observable at about 400 and 600 Hz in the 66 mph data, while at 40 mph, the peaks are shifted downward to 250 and 375 Hz. These peaks are absent in the data shown for ground rail. (However, a grinding pattern caused peaks to occur at about 1,400 and 900 Hz, respectively, at 66 and 40 mph.)

A mechanical resonance, such as that produced by resonance of the wheel set or track, will produce noise with spectral components whose frequencies do not vary with train speed. Thus, if spectral analyses for various speeds indicate no change in the peak frequency with varying train speed, the cause of the noise is likely not rail corrugation or any other periodic pattern in the rail. On the other hand, mechanical resonances will be excited by rail corrugation, and the amplitude of the resulting noise may vary substantially, depending on the relationship between corrugation frequency and the mechanical resonance frequency.

Machine bluing, magnaflux dye, or lamp black spread over the rail running surface may be helpful in identifying corrugation waves. The corrugation wavelength may be measured

and compared with noise spectra obtained at the same location to determine if corrugation is a significant source of the noise. A rail profilometer can be used for evaluation of wear rates and grinding effectiveness.

4.2.4.2 Wheel/Rail Interaction at Corrugated Rail

The interaction between the wheel and rail in the presence of corrugation may be considerably more complex than that described by the standard linear model used to describe normal rolling noise. One principal reason is that contact separation may occur as a result of the inability of the wheel to follow the corrugated rail’s vertical profile. For example, the force required to displace the center of gravity of an 800-lb wheel by 0.005 in. is about 10,000 lb, roughly similar to the wheel static load, assuming the wheel to be rigid. Contact patch stiffness, rail compliance, and wheel resonances will modify this estimate. Higher amplitude corrugation would produce higher dynamic loads, except that the static load places a limit on the maximum dynamic load that can occur during an unloading cycle. Thus, there must be a contact separation at higher amplitudes. Corrugations of even moderate amplitude can be expected to produce contact separation, or

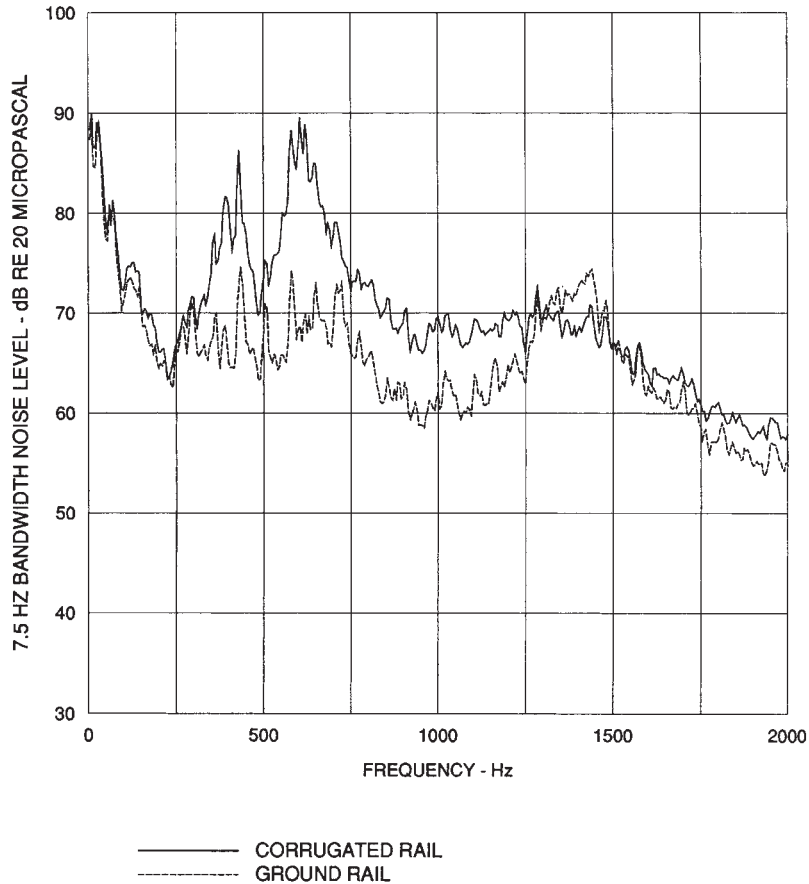

FIGURE 4-15 INTERIOR NOISE AT 66 MPH ON CORRUGATED RAIL (TRANSBAY TUBE)

at least an increased propensity for lateral dynamic slip between the wheel and rail due to unloading of the contact patch. Periodic lateral slip can then lead to additional periodic wear and corrugation, producing regenerative wear.

Figure 4-17 illustrates 1/3-octave band noise levels with and without corrugation. In these cases, a corrugation amplitude of merely 0.002 in. produces noise at a discrete frequency in the 630 Hz octave band roughly 8 to 10 dB higher relative to neighboring bands. A larger amplitude of 0.004 in. produces a broader spectral peak between 500 and 1,000 Hz. The actual conditions under which these data were taken are not known, but the broader bandwidth associated with corrugation amplitude of 0.004 in. versus an amplitude of 0.002 in. suggests that the noise generation process might be different between these two sets of data. Contact separation is a possible mechanism by which this might be brought about. More importantly, the data indicate that only a relatively small corrugation amplitude is sufficient to produce a substantial increase in wayside noise levels.

In the presence of lateral slip or contact separation, the equality of lateral dynamic displacement of the wheel and rail is relaxed. A practical result is that the wheel's lateral vibration modes may be easily excited, with the result that the ratio of noise energy radiated by the wheel relative to that

radiated by the rail may be more with corrugated rail than with uncorrugated rail.

Modeling of wheel/rail noise in the presence of contact separation or lateral dynamic slip is complicated by the nonlinearity of the contact vertical load versus vertical displacement, and lateral slip versus vertical displacement. A realistic theoretical model requires time-domain integration of the equations of motion, and simple modeling with the usual linear theories may be inadequate. For example, accounting for the nonlinearity of the Hertzian contact patch stiffness as a function of dynamic load indicates that dynamic contact forces may be higher than those predicted on the basis of constant contact patch stiffness, exceeding the wheel static load for rail roughness amplitudes on the order of 0.001 in. and trains traveling at close 80 or 90 mph, further encouraging lateral slip during unloading (21), which has been identified with the corrugation process (22).

To summarize, rail corrugation is more difficult to control at rail transit systems than at railroads because of lighter contact patch loads at rail transit systems. The uniformity of transit vehicle types and speeds prevents randomization of wheel/rail force signatures, which simply exacerbates the corrugation process. Thus, for rail transit systems with lightly loaded rails, the importance of maintaining rail smoothness is greater than at heavy freight systems. Rail cor-

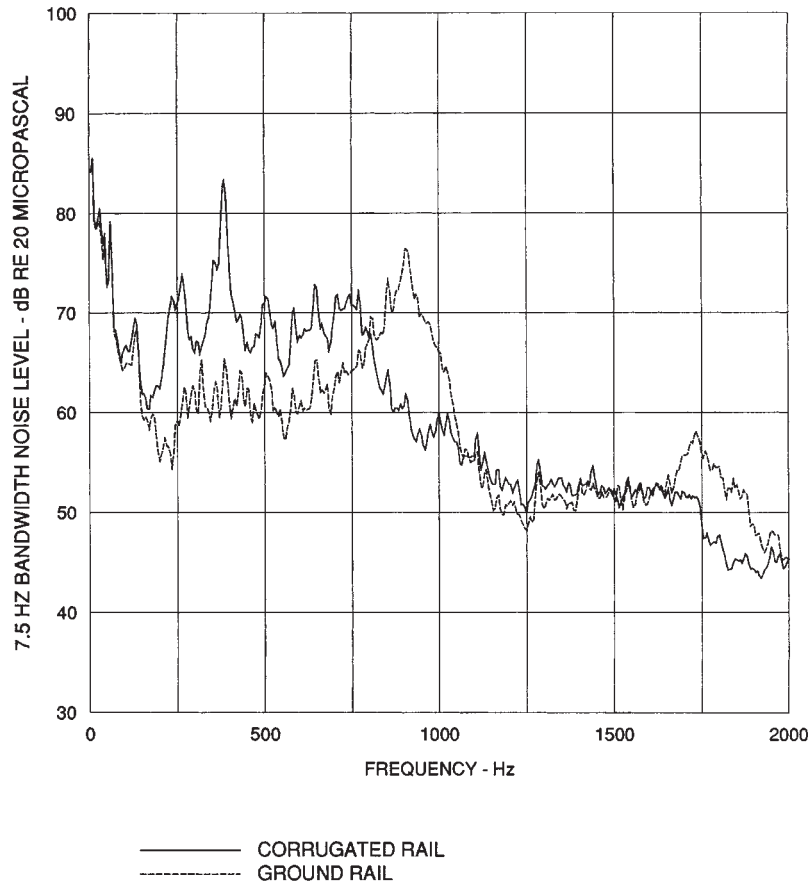

FIGURE 4-16 INTERIOR NOISE AT 40 MPH WITH CORRUGATED RAIL (BART TRANSBAY TUBE)

rugation is the principal cause of excessive noise levels at many transit systems, and controlling rail corrugation is key to rail transit system noise control.

Rail corrugation processes and methods of control are discussed in greater detail in the chapter on rail corrugation.

4.3 CURVING NOISE

Curving noise includes both normal rolling noise, which also occurs at tangent track, and noise unique to curving, resulting from lateral slip of the wheel tread across the rail head. Noise due to lateral slip is often manifested as an intense, sustained squeal, caused by the negative damping associated with the friction versus creep characteristic. Normal rolling noise will not be significant at short radius curves, especially in the presence of wheel squeal, due to low train speed, and at high-speed curves, rolling noise may be treated in much the same manner as for tangent track. This section is directed entirely to curving noise due to lateral slip generated noise.

There appear to be two types of curving noise. The first and most prevalent is wheel squeal caused by sustained nonlinear lateral oscillation of the wheel. The second, less obvious, and less common, is wheel howl, which may be due to the resonant but unsaturated response of the wheel to dynamic lateral

creep forces. There are reasons to believe that these types of curving noise are separate phenomena: (1) they do not sound the same; (2) wheel howl at curves increases with train speed, while conventional wheel squeal may disappear with sufficiently high train speed; and (3) wheel/rail howl may be closely associated with short pitch corrugation at curves. Of these two types of curving noise, wheel squeal is the more prevalent, while wheel howl may be limited to lightly damped aluminum centered wheels such as used at BART. In fact, wheel howl may be unique to BART, because BART is the only transit system employing rigid aluminum centered wheels.

4.3.1 Wheel Squeal

Wheel squeal is one of the most noticeable types of noise produced by rail transit systems, and can be very significant at both short and long radius curves. At embedded track curves of light rail systems, pedestrians and patrons may be in close proximity to the vehicle and thus be subjected to high squeal noise. An example is the Government Center Curve at the Boston Green Line, where transit patrons are necessarily within a few ft of the track within an enclosed underground area, without the benefit of shielding by a platform. At older transit systems where windows may be left open during passage through subways, squeal

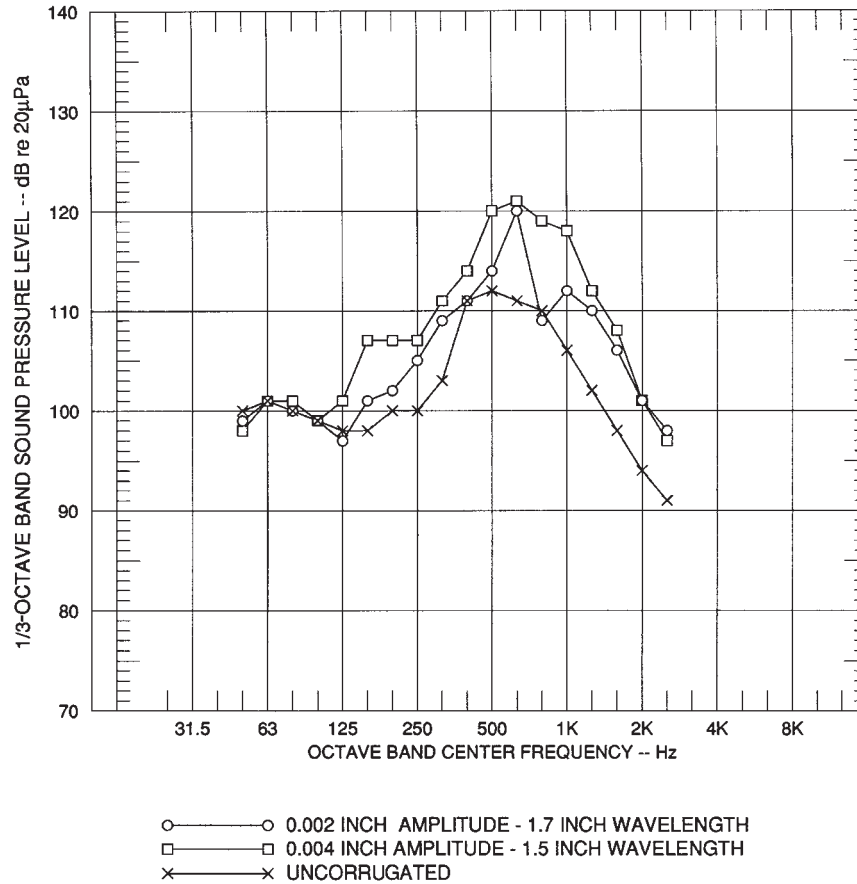

FIGURE 4-17 WAYSIDE NOISE LEVELS DUE TO RAIL CORRUGATION (SPENO INTERNATIONAL)

can be discomforting to patrons inside the vehicle, especially if no substantial sound absorption exists in the subway. Even in modern transit vehicles, inadequate door seals may allow exposure of patrons to high levels of squeal noise in tunnels.

Wheel squeal may be intermittent due to varying tribological properties, varying amounts of rail surface contaminants, or curving dynamics of the vehicle and rail. An example of the time dependence of wheel squeal is provided in Figure 4-18. In this case, the squeal is produced by a Portland Tri-Met vehicle with resilient wheels on an 87-ft radius embedded track curve. The squeal noise level varies considerably over time. On damp mornings, wheel squeal may be nonexistent for all or most of the curve negotiation. The maximum level of squeal noise is relatively insensitive to duration and frequency of occurrence.

Maximum and energy-averaged 1/3-octave band spectra of the wheel squeal illustrated in Figure 4-18 for the Tri-Met vehicle are provided in Figure 4-19. These data include fundamental squeal frequencies in the 500, 1,250, and 3,150 Hz 1/3-octave bands. The high levels of noise at discrete squeal frequencies indicate the high level of perceptibility and potential for annoyance. The maximum levels shown are the maximum observed 1/3-octave noise levels occurring during curve negotiation, and may not have occurred simultane-

ously. The lower levels are the energy-averaged, or rms, sound levels occurring during curving. In this example, there exists considerable disparity between the maximum sound level and energy-averaged sound level, caused by the intermittency of the squeal.

Figure 4-20 illustrates the narrowband frequency spectrum of wheel squeal recorded at BART during the Car 107 tests in 1971 at a 540-ft radius curve. These data include sustained squeal at frequencies above 1,000 Hz and low train speed of 18 mph. At a train speed of 35 mph, the squeal above about 1,000 Hz is absent. The inhibition of squeal at higher train speeds is a feature of wheel squeal that is due to reduced negative damping at higher lateral slip velocities, as discussed below.

4.3.1.1 Causes of Wheel Squeal

Three types of stick-slip motion have been postulated for producing wheel squeal noise:

- 1) Longitudinal stick-slip,
- 2) Flange contact with the gauge face, and
- 3) Stick-slip due to lateral creep across the rail head caused by nonzero angle of attack of the wheel, in turn produced by the finite wheel base of the truck.

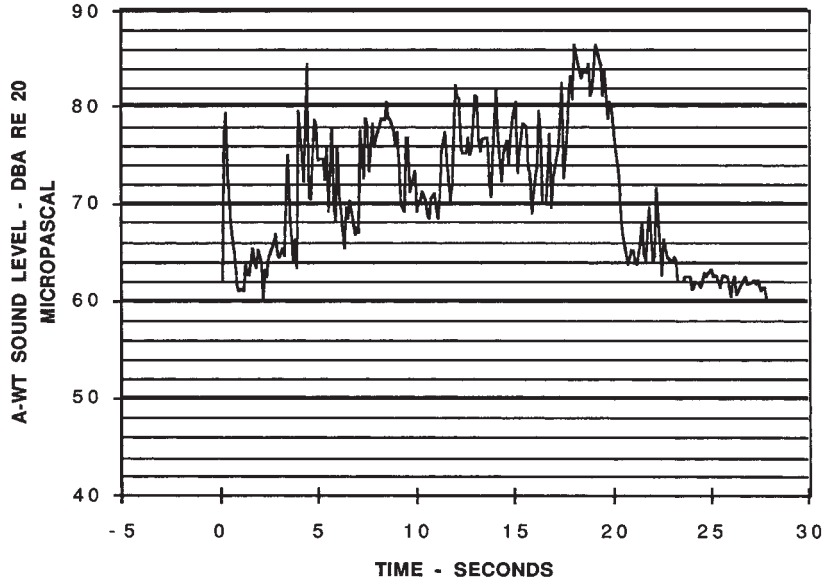

FIGURE 4-18 WHEEL SQUEAL FROM ARTICULATED LIGHT RAIL VEHICLE WITH RESILIENT BOCHUM WHEELS ON EMBEDDED TRACK WITH 87-FOOT RADIUS CURVE

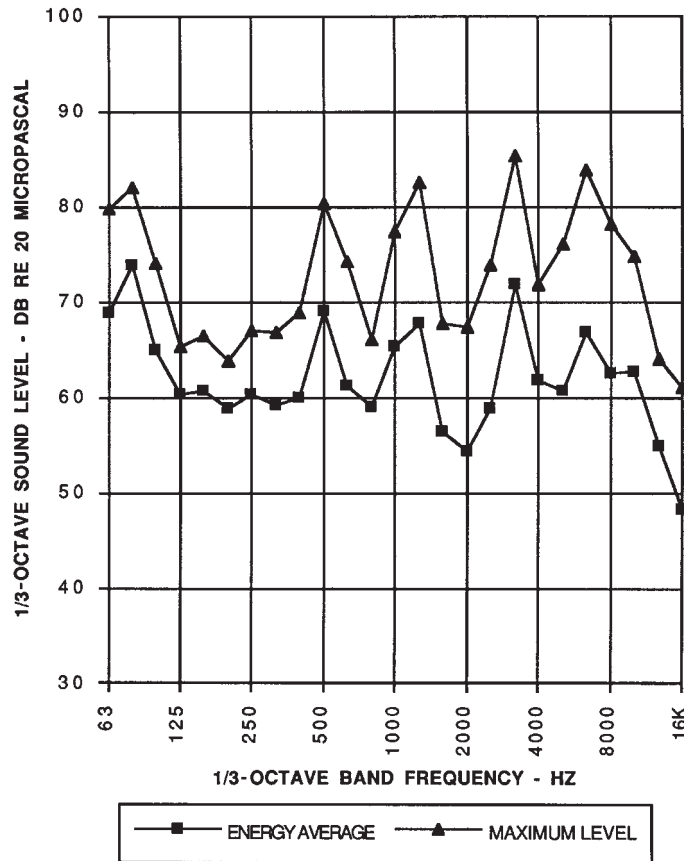

FIGURE 4-19 WHEEL SQUEAL AT PORTLAND TRI-MET WITH RESILIENT BOCHUM WHEELS ON URETHANE EMBEDDED TRACK WITH 87-FOOT RADIUS CURVE

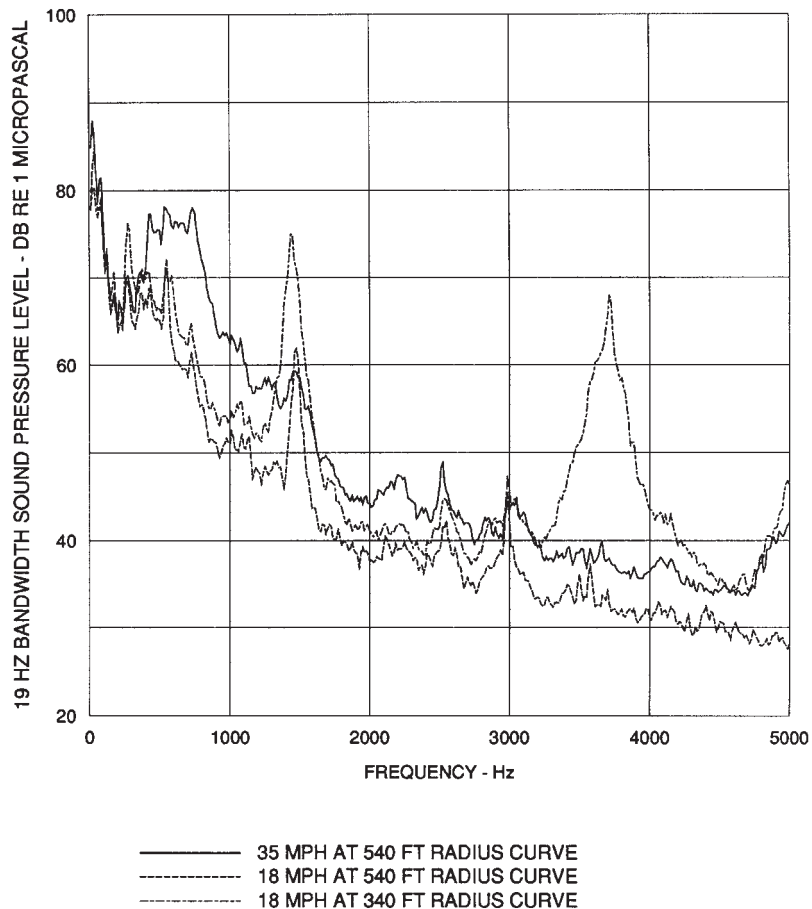

FIGURE 4-20 CURVING NOISE IN BART CAR 107 WITH ALUMINUM CENTERED WHEELS ON GROUND RAIL (1971)

Longitudinal stick-slip is due to the different translation velocities between the high and low rail wheels. Wheel taper is sufficient to compensate for differential slip at curves in excess of about 2,000-ft radius, though shorter radii may be accommodated by profile grinding of the rail head. Further, Rudd reports that elastic compression of the inner wheel and extension of the outer wheel tread under torque can compensate for the wheel differential velocities, and, further, that trucks with independently driven wheels also squeal (23). Therefore, longitudinal slip is not considered to be a cause of wheel squeal.

Flange rubbing is due to contact between the flange and high rail and has been considered by many as a cause of wheel squeal. However, lubrication of the flange does not always eliminate wheel squeal, and (according to Rudd) Stappenbeck reports that the low rail wheel has been identified as the source of wheel squeal, which does not ordinarily undergo flange rubbing (24). These observations suggest that flange contact is not a significant cause of squeal. However observations of noise at the MBTA Green Line indicate that substantial squeal is produced by the unrestrained high rail

wheels at a short radius curve, and little or none by the low rail restrained wheels. Substantial flange rubbing occurs at the high rail leading wheel, suggesting that flange rubbing contributes to squeal. Further, it is not clear whether the leading or trailing wheel is the source, and the trailing wheel flange does not contact the gauge face. Other observations at the MBTA Red Line indicate that squeal occurs at points of repeated flange contact with the high rail, though, in this case, determining whether the high or low rail wheels are the sources of squeal was not possible. Flange lubrication is used to reduce rail wear and noise at curves, but the noise reduction observed with flange lubrication may be due to migration of lubricant to the rail running surface.

Lateral slip of the tread running surface across the rail head is *the most probable cause* of wheel squeal, and is most tractable from a theoretical point of view. Even though flange contact is often observed at sections of track where squeal occurs, such as at the MBTA, the squeal may be due entirely to lateral slip across the rail head. The lateral slip theory of wheel squeal is discussed more fully below.

4.3.1.2 Lateral Slip Model

Figure 4–21 illustrates the geometry of curve negotiation by a transit vehicle truck as described in the literature. As illustrated, lateral slip across the rail head is necessitated by the finite wheel base, B , of the truck, and the radius of curvature of the rail, where no longitudinal compliance exists in the axle suspension. However, this curving diagram is not realistic of actual performance. Figure 4–22 illustrates the crabbing of a truck under actual conditions (25). In this case, the leading axle of the truck rides toward the outside of the curve, limited only by flange contact of the high rail wheel against the gauge face of the rail. The trailing axle, however, travels between the high and low rail, and the low rail wheel flange may, in fact, be in contact with the low rail gauge face. The result is a reduction of creep angle at the trailing axle, but an increase of creep angle at the leading axle. Gauge widening would only increase the actual creep angle under these circumstances. Moreover, with severe creep angle,

flange rubbing at the high rail occurs, contributing to wear. This crabbing condition is particularly observable at the MBTA Green Line Government Center Station curve.

The theory of stick-slip oscillation is presented below in some detail in an attempt to clarify the literature. Figure 4–23 is a schematic of the wheel and rail system, for which various parameters are defined. The most useful way of thinking about squeal is to consider the problem from the center of gravity of the wheel, and think of the rail as slipping beneath the tire in the lateral direction at an average slip velocity, V . The deflection of the tire at the contact point, relative to the center of the tire, is represented by U . The velocity of the tire relative to the center of the wheel is then dU/dt . Then, the total creep velocity of the tire relative to the rail head is $V - dU/dt$. If the rolling velocity is defined as S , then the total creep is defined as

$$\xi = V - \frac{dU}{dt}$$

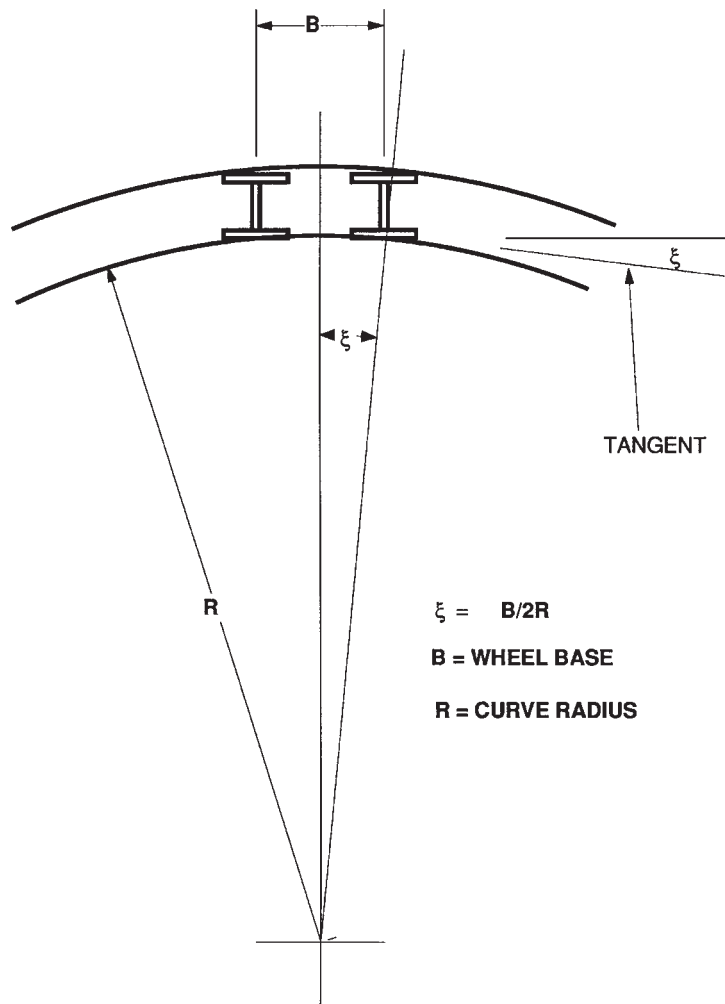

FIGURE 4-21 GEOMETRY OF CURVE NEGOTIATION AND LATERAL SLIP

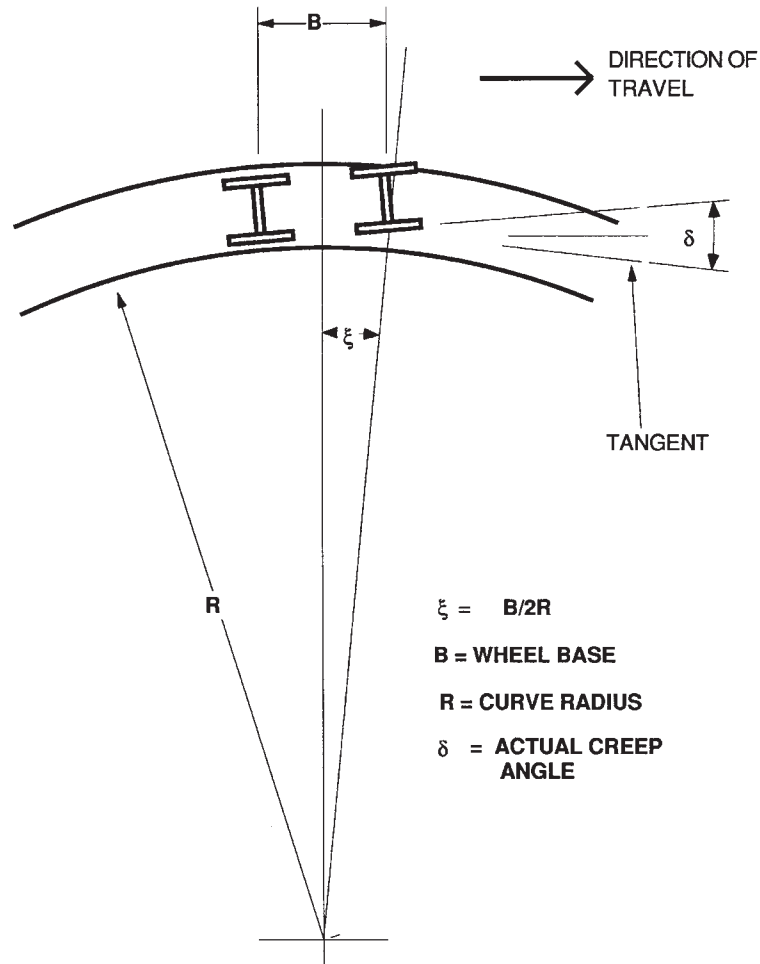

FIGURE 4-22 TRUCK CRABBING UNDER ACTUAL CONDITIONS

and the average creep for a lateral slip velocity, V , is

$$\xi_0 = \frac{V}{S}$$

The friction coefficient, μ , is assumed to be entirely a function of the total creep, ξ .

The equation of motion is obtained by setting the acceleration of the wheel tread equal to the sum of the forces acting on the tread, which includes the forces due to the stiffness of the wheel, the internal damping of the wheel, and the friction force, μW , where W is the vertical contact load

$$m \frac{d^2 U}{dt^2} = -kU - c \frac{dU}{dt} + \mu W$$

The friction coefficient can be expanded about the average creep, ξ_0 :

$$\mu = \mu_0(\xi_0) + \left. \frac{d\mu}{d\xi} \right|_{\xi_0} (\xi - \xi_0) + \dots$$

Now define the slope of the friction-creep function, μ , as

$$v = \left. \frac{d\mu}{d\xi} \right|_{\xi_0}$$

Defining the deflection of the tread as the sum of a steady state deflection, $U_0 = \mu_0 W$, and a dynamic component, u , so that $U = U_0 + u$, the dynamic component of the creep can be expressed as

$$\xi - \xi_0 = -\frac{1}{S} \frac{dU}{dt} = -\frac{1}{S} \frac{du}{dt}$$

Then, the equation of motion becomes

$$m \frac{d^2 u}{dt^2} + \left[c + v \frac{W}{S} \right] \frac{du}{dt} + ku = 0$$

The solution of this equation is

$$u = u_0 e^{\pm i \left[\frac{k}{m} - \frac{1}{4m} \left(c + v \frac{W}{S} \right)^2 \right]^{1/2} t} e^{-\frac{1}{2m} \left(c + v \frac{W}{S} \right) t}$$

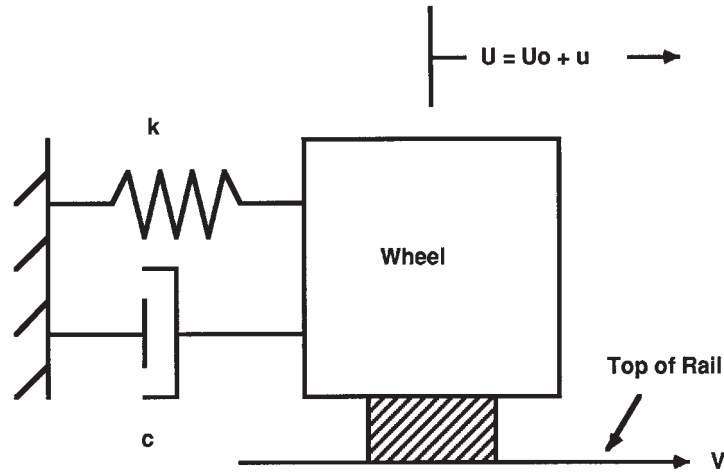

Deflection:	U
Spring return force:	-kU
Internal damping force:	-cdU/dt
Friction force:	-μ W
Friction Coefficient:	μ(ξ)
Lateral Creep:	ξ = (V-dU/dt)/S
Average Creep Velocity:	V
Rolling Velocity:	S
Normal load:	W

FIGURE 4-23 MODEL OF WHEEL SQUEAL GENERATION

Thus, exponential growth of the solution occurs if the slope, v , of the friction-creep curve is sufficiently negative to overcome the internal dissipation, c .

4.3.1.3 Loss Factor Due to Stick-Slip

The internal damping and negative damping due to stick-slip are described by Rudd in terms of loss factors (26).

The combined loss factor for the wheel vibration in the axial direction is

$$\eta = \eta_{int} - \eta_{ss}$$

where

$$\eta_{int} = \text{internal loss factor} = c/m\omega$$

$$\eta_{ss} = \text{Loss factor due to stick-slip} = -vW/m\omega S$$

$$m = \text{modal mass}$$

$$\omega = \text{radian frequency} = (k/m)^{1/2}$$

If the slope, v , of the friction coefficient versus lateral creep, is negative, then the loss factor due to stick-slip is positive. If the loss factor due to stick-slip is large enough, the combined loss factors due to stick-slip and internal energy dissipation will be negative, resulting in amplification of vibration at a modal frequency, as described above. The modal mass is assumed to be about $1/3$ of the wheel mass, given in a consistent system of units.

The loss factor due to stick-slip is inversely proportional to the rolling velocity of the wheel, because the creep function is independent of rolling velocity (the creep is equal to the ratio of the slip velocity and rolling velocity). Thus, wheel squeal may be expected to cease above a certain velocity speed where the loss factor due to stick-slip is not sufficient to overcome the loss factor due to internal damping. The form of the friction versus creep used by Rudd is illustrated in Figure 4-24 and is given by

$$\mu = \mu_{max} \frac{\xi}{\xi_m} \exp(1 - \xi/\xi_m)$$

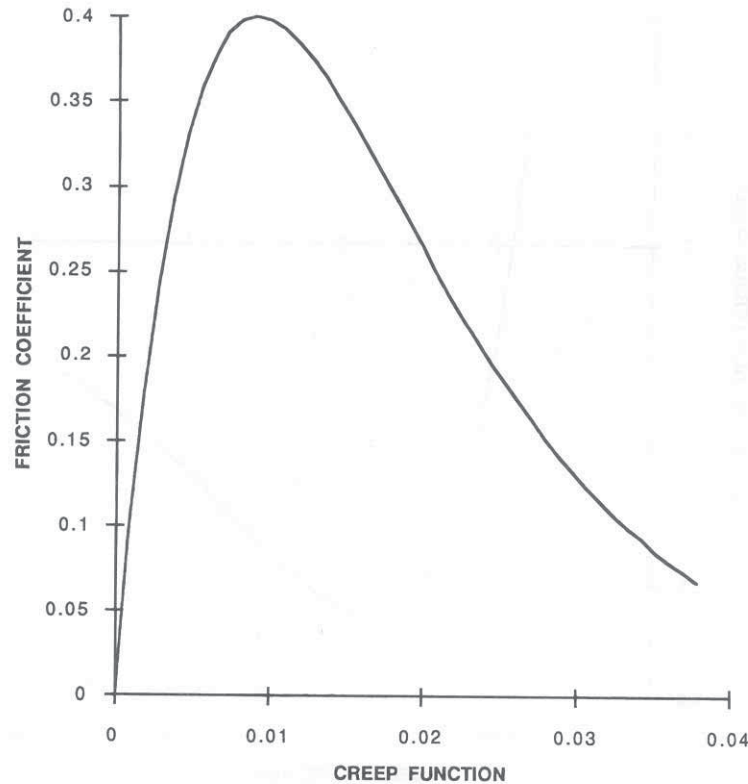

FIGURE 4-24 FRICTION VERSUS CREEP

Here, ξ_m , is the value of ξ at maximum friction coefficient, μ_{\max} . At a creep angle of about 0.009 radians (0.5 deg), the friction coefficient reaches a maximum value of about 0.4. The corresponding slope of the friction versus creep curve is illustrated in Figure 4-25. Above the maximum friction point, the slope becomes negative, and unstable oscillations may occur, though the occurrence still depends on the magnitude of the slope. Below the maximum friction point the curve has positive slope, and thus would not produce stick-slip oscillation.

For a wheel base of 7.5 ft, squeal would not be expected for curve radii greater than 410 to 830 ft, the lower limit being achieved when there is no gauge relief. As illustrated above, gauge widening increases the creep angle for the same radius of curvature. A typical assumption is that squeal does not occur for curves with radii greater than about 700 ft, corresponding to a creep rate given by

$$\xi = 0.7B/R$$

where

B = wheel base

R = curve radius

4.3.1.4 Effect of Internal Loss Factor

The internal loss factor required to overcome the negative friction due to stick-slip can be estimated by equating the loss

factor due to internal damping to the absolute value of the loss factor for stick-slip. In this case, the loss factor varies as a function of curve radius due to varying crab angle, or creep, and train speed, as illustrated in Figure 4-26. Two curves are shown for vehicle lateral accelerations of 3% and 15% of earth's gravitational acceleration. The lateral acceleration is determined from the forward velocity of the vehicle and curve radius. For example, the typical speed of a BART rail transit vehicle in a 540-ft radius curve is about 35 mph, corresponding to a lateral acceleration of about 15% of gravity. At high train speed and lateral acceleration, the minimum loss factor due to stick-slip is about 20%. At low speed, corresponding to lateral acceleration of 3%, the loss factor is considerably higher.

In practice, wheel squeal is usually inhibited by wheels with lower loss factors than necessary to compensate for the theoretical negative damping effect. Loss factors for resilient and damped wheels which have been shown to eliminate or at least partially reduce squeal are provided in Table 4-1. Immediately apparent is that the loss factors of these wheels are much less than predicted to inhibit stick-slip oscillation (illustrating the complexity and difficulty in achieving a satisfactory theory of wheel squeal phenomena.) Deficiencies in the model likely concern the friction-versus-creep representation.

4.3.1.5 Friction

Meteorological conditions affect the generation of squeal. In wet weather, for example, wheel squeal occurrence may

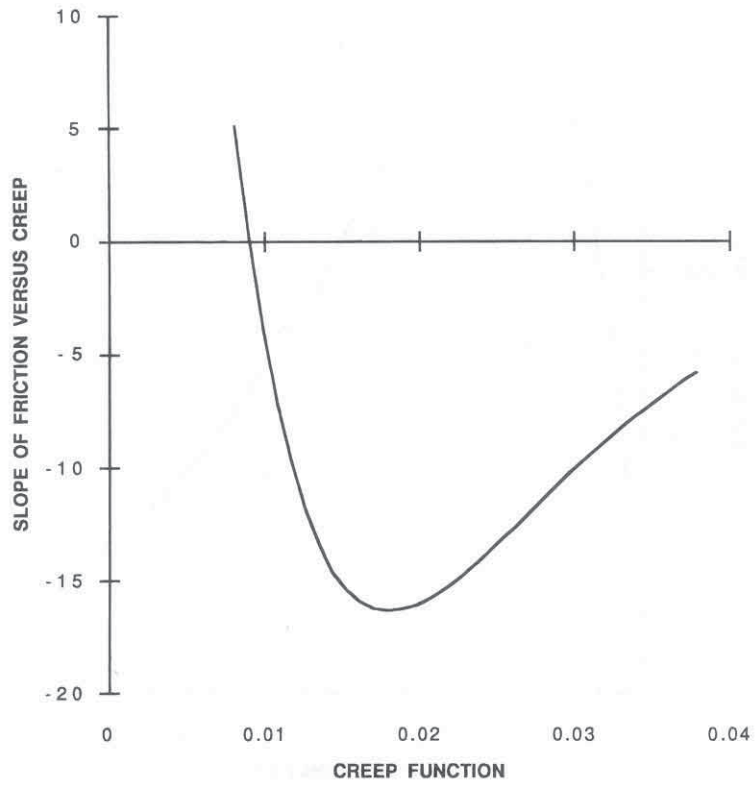

FIGURE 4-25 SLOPE OF FRICTION VERSUS CREEP CURVE

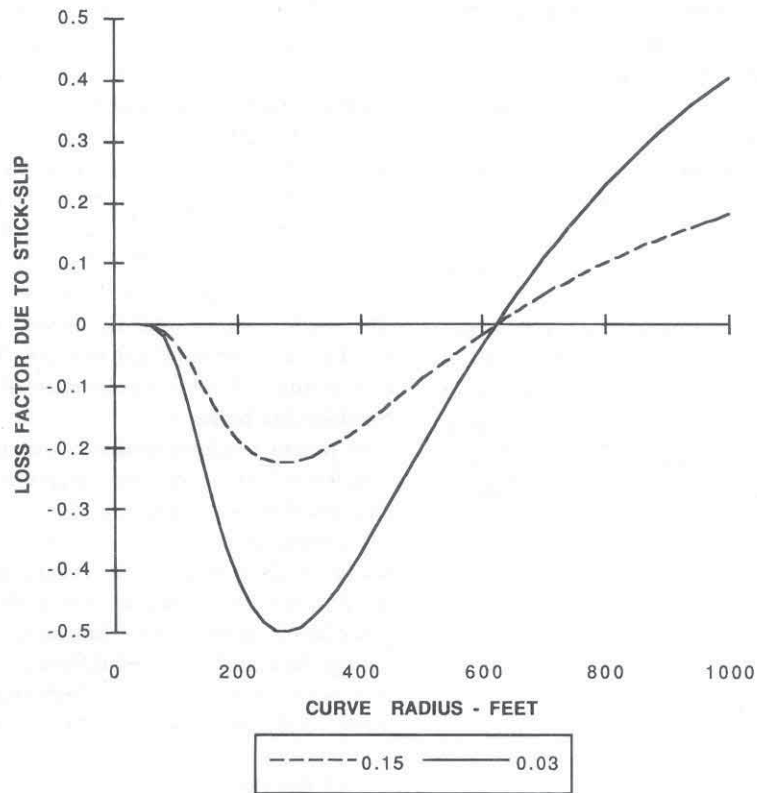

FIGURE 4-26 LOSS FACTOR AS A FUNCTION OF CURVE RADIUS FOR TWO LATERAL ACCELERATIONS

TABLE 4-1 LOSS FACTORS FOR RESILIENT AND DAMPED WHEELS

Wheel Type	Frequency - Hz		
	500	1000	2000
Bochum	.012	.014	.0072
SAB	.0026	.0016	.0009
Acousta-Flex	.012	.0051	.0034
Ring damped	.0009	.0004	.0019

Reference: Remington, JSV 116(2), 1985

be greatly reduced, due to the change in friction characteristics caused by moisture. Water sprays are known to control squeal at curves, and lubrication of the flanges is often claimed to reduce squeal. In this latter respect, however, flange lubrication may only be effective to the extent that the lubricant migrates onto the rail head if squeal is due entirely to stick-slip between the tread and rail running surface.

The coefficient of friction varies substantially as a function of slip velocity for contacting metal surfaces of identical materials. Under vacuum conditions, steel or iron surfaces without contamination or oxidation will weld together if not maintained in relative motion, while contamination and oxidation prevent welding from occurring under normal atmospheric conditions (27). Regardless of contaminants, the static friction is normally greater than the dynamic friction coefficient for steel-steel contact. Under lateral creep in the presence of longitudinal rolling contact, the friction versus creep curve differs from one in which only sliding contact in a single direction is involved. Again, as discussed above, the friction versus creep curve for lateral creep in the presence of rolling contact is assumed to be smooth through zero lateral creep, reaches maximum at some finite creep, and thereafter decreases monotonously with increasing creep, producing the negative slope of friction versus creep discussed above.

Modification of the friction-creep curve is an attractive approach to noise control. Dry-stick friction modifiers applied to the wheel tread, and, thus, the rail running surface, improve adhesion and flatten the friction-creep curve, thereby reducing or eliminating the negative damping effect. A second possible means of modifying the friction versus creep curve is to employ metals of dissimilar metallurgical composition. An intriguing possibility is to employ alloy steel rails with sufficiently different metallurgical properties than those of the steel wheel treads. No data collection efforts nor tests have been conducted to investigate this approach, though some rail head inlays are reputed to reduce wheel squeal at curves. Nitinol (Nickel-Titanium) wheel treads have been considered for reduction of wheel squeal and improvement of traction, though no full-scale tests have been conducted.

4.3.2 Wheel/Rail Howl

Wheel/rail howl is another type of tonal noise produced by curving vehicles. The howl is contained within a frequency

band ranging from about 250 to 750 Hz. An example of wheel/rail howl for BART Car 107 on ground rail is also included in Figure 4-20. On systems with steel centered wheels and tires, wheel howl is believed to be less of a problem, or nonexistent, because of a higher damping ratio for solid steel wheels. Because BART is the only system employing aluminum centered wheels, wheel howl may be unique to BART. The wheel howl appears to increase with train speed, especially in the example provided in Figure 4-20. Wheel squeal, on the other hand, may actually disappear with sufficient speed. Thus, the phenomenon of wheel/rail howl appears to be distinct from squeal.

4.3.2.1 Mechanism of Wheel/Rail Howl

Wheel/rail howl appears to be controlled by the fundamental lateral mode of oscillation of the wheel and low damping ratio for aluminum centered wheels with steel tires. The phenomenon probably involves lateral slip of the tire across the rail running surface, but is possibly not a sustained oscillation of the type associated with well-developed squeal, as evidenced by the larger bandwidth of the noise compared with that of wheel squeal. To the extent that howl is presumed to involve lateral slip, the process probably involves negative damping as does wheel squeal, for which the treatment would be essentially the same. That is, flattening the friction-creep curve or increasing the internal damping of the wheels should reduce the incidence of wheel howl at curves, as supported by the Car 107 tests at BART with the resilient Bochum wheel and a damped wheel (28).

4.3.2.2 Relation to Rail Corrugation

The howl appears to grow with time after rail grinding at large radius curves due to emergence of rail corrugation, and the corrugation formation is believed to be directly related to the vibration producing the howl. Thus, a regenerative effect may occur, where lateral oscillation over a broad frequency band encompassing the wheel's fundamental modal frequency produces rail corrugation with the same corrugation frequency. The corrugation further excites the wheel, increasing the amplitude of vibration of the wheel and radiated noise.

The process appears to occur at large as well as small radius curves. The howling noise also appears at tangent track, usually associated with corrugation. One might conclude, therefore, that, at least at BART, the wheel's dynamic properties which contribute to howl at curves are also related to formation of corrugation at tangents and moderately curved track. That is, the wheel howl at curves is controlled by resonances in the wheel which are also active at tangent track in the formation of short-pitch corrugation through dynamic lateral slip.

Fortunately, most rail transit systems do not employ composite aluminum centered wheels, and the problem may be limited to those systems that do. The most attractive mitigation measure is to use wheels with higher damping ratio, such as solid steel wheels. Wheels with tapered treads and sufficient longitudinal compliance in the primary suspension will tend to self-steer, align the axle with the curve radius, and, thus, reduce or eliminate lateral slip and howl. Wheel vibration absorbers, damped wheels, and resilient wheels, also reduce or eliminate wheel howl.

4.4 SPECIAL TRACKWORK

Special trackwork includes switches and crossover diamonds. Impact noise generation occurs as the wheel traverses a switch frog or crossover diamond gap. A second source of impact noise is the vertical ramp at the switch points, which typically exhibits a lot of damage because of wheel impact forces. Impact noise from special trackwork is very noticeable to wayside receivers and transit patrons, with A-weighted maximum noise levels roughly 7 to 10 dBA (fast sound level meter response) greater than levels at tangent track with ground rail. Special trackwork noise will generally be greater than that due to rail joints, because of the much larger gap that must be traversed. The noise radiation characteristics from special trackwork are significantly different from those of a long train on ground rail. For one, special trackwork noise radiation is primarily confined to the vicinity of the frog and switch points. Secondly, at large distances from very long trains, the wheel/rail noise radiated from the tangent portions of the track may be comparable with or greater than that attributable to the switch frog and points.

The theory of impact noise generation at special trackwork frogs is represented by that for level rail joints with finite gap. The radiating surfaces of impact noise at special trackwork have not been studied in detail, and one must assume that the wheel, frog, and ties are all significant radiators. On concrete bridge decks, deck radiated noise may also be significant. If steel girders are included, substantial structure radiated noise may be expected at low frequencies in the range of 50 to 500 Hz. There is also the possibility of truck frame or other component radiated noise, though this has not been documented.

Special frogs such as moveable point frogs and spring frogs have been developed to reduce or eliminate impact

forces and noise. These are discussed further in the chapter on trackwork treatments.

4.5 REFERENCES

1. Saurenman, H. J., J. T. Nelson, and G. P. Wilson, *Handbook of Urban Rail Noise and Vibration Control*, Wilson, Ihrig & Associates, Inc., for U.S.DOT/UMTA, UMTA-MA-06-0099-82-1 (February 1982).
2. Kalousek, J., and K. L. Johnson, "An Investigation of Short Pitch Wheel and Rail Corrugation on the Vancouver Skytrain Mass Transit System," *Proc., Institute of Mechanical Engineers*, Vol. 206 (1992) pp. 127-135.
3. Remington, P. J. et al. *Wheel/Rail Noise and Vibration: Vol. 1, Mechanics of Wheel/Rail Noise Generation, and Vol. 2, Applications to Control of Wheel/Rail Noise*, U.S. Department of Transportation, UMTA-MA-06-0025-75-10 (1975).
4. Thompson, D. J. et al. *Track Wheel Interaction Software (TWINS) User Manual*, Version 2.2., TNO/TPD Report TPD-HAG-RPT-93-0213, prepared for the ERRI Committee, No. C163 (1994).
5. Remington, P. J., "Wheel/Rail Rolling Noise: What Do We Know? What Don't We Know? Where Do We Go From Here?," *Journal of Sound and Vibration*, Vol. 120, No. 2, (1988) pp. 203-226.
6. Thompson, D. J. et al., *Track Wheel Interaction Software (TWINS) User Manual*. Version 2.2, TNO/TPD Report No. TPD-HAG-RPT-93-0213, prepared for the ERRI Committee, No. C 163 (1994).
7. Knothe, K. L., and S. L. Grassie, "Modelling of Railway Track and Vehicle/Track Interaction at High Frequencies," *Vehicle System Dynamics*, Vol. 22 (1993) pp. 209-262.
8. Remington, P. J. et al., *Control of Wheel/Rail Noise and Vibration*, U.S. Department of Transportation, Urban Mass Transportation Administration, Transportation Systems Center UMTA-MA-06-0099-82-5 (April 1983) pp. 32-42.
9. Langley, R. S., "Wave Transmission Through One-Dimensional Near Periodic Structures: Optimum and Random Disorder," *Journal of Sound and Vibration*, Vol. 188, No. 5 (1995) pp. 717-743.
10. Remington, P. J., *The Estimation and Control of Rolling Noise Due to Roughness*, BBN Report No. 8801, prepared for the ERRI Committee, No. C163 (1994)
11. Barsikov, B., W. F. King, III, and E. Pfitzenmaier, "Wheel/Rail Noise Generated by a High Speed Train Investigated with a Line Array of Microphones," *Journal of Sound and Vibration*, Vol 18, No. 1 (1987) pp. 99-122.
12. Peters, S., "The Prediction of Railway Noise Profiles," *Journal of Sound and Vibration*, Vol. 32, No. 1 (1974) pp. 87-99.
13. Pierce, A. D., *Acoustics: An Introduction to Its Physical Principles and Applications*, McGraw-Hill (1981) pp. 158-167.
14. Saurenman, H. J., G. P. Wilson, and J. T. Nelson, *Handbook of Urban Rail Noise and Vibration Control*, Final Report, Wilson, Ihrig & Associates, Inc., for U.S.DOT/UMTA, UMTA-MA-06-0099-82-1 (February 1992) pp. 3-33.
15. *Transit Noise and Vibration Impact Assessment*, Federal Transit Administration, U.S. Department of Transportation, DOT-T-95-16 (April 1995) p. E-2.

16. *Transit Noise and Vibration Impact Assessment*, Federal Transit Administration, U.S. Department of Transportation, DOT-T-95-16 (April 1995) Table 6-3.
 17. Saurenman, H. J., G. P. Wilson, and J. T. Nelson, *Handbook of Urban Rail Noise and Vibration Control*, Final Report, Wilson, Ihrig & Associates, Inc., for U.S.DOT/UMTA, UMTA-MA-06-0099-82-1 (February 1992) pp. 3-34.
 18. *Transit Noise and Vibration Impact Assessment*, Federal Transit Administration, U.S. Department of Transportation, DOT-T-95-16 (April 1995) Ch. 6, pp 22.
 19. Ver, I. L., C. S. Ventres, and M. M. Myles, "Wheel/Rail Noise—Part III: Impact Noise Generation by Wheel and Rail Discontinuities," *Journal of Sound and Vibration*, Vol. 46, No. 3 (1976) pp. 395-417.
 20. Private communication by A. Bohara of SEPTA, September 1996.
 21. Knothe, K. L., and S. L. Grassie, "Modelling of Railway Track and Vehicle/Track Interaction at High Frequencies," *Vehicle System Dynamics*, Vol. 22 (1993) p. 258.
 22. Knothe, K. L., and B. Ripke, "The Effects of the Parameters of Wheelset, Track and Running Conditions on the Growth Rate of Rail Corrugations," *The Dynamics of Vehicles on Roads and on Tracks*. Proc. 11th IAVSD Symposium, Kingston, Ont., 1989, Swets & Zeitlinger, Amsterdam/Lisse (1990) pp. 345-356.
 23. Rudd, M. J., "Wheel/Rail Noise—Part II: Wheel Squeal," *Journal of Sound and Vibration*, Vol. 46, No. 3 (1976) p. 383.
 24. Von Stapenbach, H., "Streetcar Curve Noise," *Zeitschrift Vereinshaft Deutscher Ingenieuren*, Vol. 96 (1974) pp. 171-175.
 25. Kurek, E. G., "Vehicle and Rail Information and Discussions Regarding the Effects of Forces, Wear, and Derailment Safety," *Railroad Track Theory and Practice (Part 3)*, Ed. Fritz Fastenrath, Frederick Ungar Publishing Co., New York (1981) p. 85.
 26. Rudd, M. J., "Wheel/Rail Noise—Part II: Wheel Squeal," *Journal of Sound and Vibration*, Vol. 46, No. 3 (1976) p. 385.
 27. Hutchings, I. M., *Tribology: Friction and Wear of Engineering Materials*, CRC Press, Ann Arbor (1992).
 28. Wilson, G. P., *BART Car 107 Tests*, Wilson, Ihrig & Associates, Inc., for Parsons, Brinckerhoff, Tudor-Bechtel (1971).
-

CHAPTER 5 SELECTION OF NOISE CONTROL TREATMENT

- 5.1 Introduction, 67
- 5.2 Tangent Track Noise, 67
 - 5.2.1 Normal Rolling Noise, 67
 - 5.2.1.1 Onboard Treatments, 69
 - 5.2.1.2 Trackwork Treatments, 70
 - 5.2.1.3 Wayside Treatments, 71
 - 5.2.2 Excessive Rolling Noise, 73
 - 5.2.2.1 Trackwork Treatments, 73
 - 5.2.2.2 Onboard Treatments, 74
 - 5.2.2.3 Wayside Treatments, 75
 - 5.2.3 Impact Noise Control, 75
 - 5.2.3.1 Trackwork Treatments, 75
 - 5.2.3.2 Onboard Treatments, 77
 - 5.2.3.3 Wayside Treatments, 77
 - 5.2.4 Corrugated Rail Noise, 77
 - 5.2.4.1 Trackwork Treatments, 77
 - 5.2.4.2 Onboard Treatments, 79
 - 5.2.4.3 Wayside Treatments, 80
- 5.3 Curving Noise Control, 80
 - 5.3.1 Wheel Squeal, 81
 - 5.3.1.1 Onboard Treatments, 82
 - 5.3.1.2 Trackwork Treatments, 84
 - 5.3.1.3 Wayside Treatments, 85
 - 5.3.2 Wheel/Rail Howl, 86
 - 5.3.2.1 Onboard Treatments, 86
 - 5.3.2.2 Trackwork Treatments, 88
 - 5.3.2.3 Wayside Treatments, 88
- 5.4 Special Trackwork, 88
 - 5.4.1 Special Trackwork Designs for Noise Control, 88
 - 5.4.1.1 Moveable Point Frogs, 89
 - 5.4.1.2 Spring Frogs, 89
 - 5.4.1.3 Flange-Bearing Frogs, 89
 - 5.4.1.4 Welded V-Frogs, 89
 - 5.4.1.5 Welding and Grinding, 89
 - 5.4.1.6 Floating Slab Cuts, 90
 - 5.4.2 Onboard Treatments, 90
 - 5.4.2.1 Undercar Absorption, 90
 - 5.4.2.2 Suspension Design, 90
 - 5.4.2.3 Resilient Wheels, 90
 - 5.4.3 Wayside Treatments, 90
 - 5.4.3.1 Sound Barriers, 90
 - 5.4.3.2 Location, 90
 - 5.4.3.3 Receiver Treatments, 90
 - 5.4.3.4 Subway Wall Treatment, 90
- 5.5 References, 91

CHAPTER 5

SELECTION OF NOISE CONTROL TREATMENT

5.1 INTRODUCTION

This chapter is a guide for identifying and evaluating noise control treatments with respect to noise reduction effectiveness, site-specific limitations, and cost. Treatments are segregated according to tangent track, curved track, and special trackwork noise control. In each of these categories, treatments are presented for onboard, trackwork, and wayside application. Some unavoidable duplication of discussion is involved, but the intent is to provide a step-by-step approach for identifying appropriate noise control treatments for each type of noise control problem. The chapter on generation of wheel/rail noise provides a theoretical and symptomatic description of various types of wheel/rail noise.

The block diagram presented in Figure 5–1 illustrates the relationship of various categories of wheel/rail noise: (1) rolling noise at tangent track, (2) curving noise, and (3) special trackwork noise. Rolling noise at tangent and moderately curved track without squeal is most representative of conditions used for qualification testing of transit vehicles. Normal rolling noise with smooth rails and trued wheels, excessive rolling noise resulting from excessive random rail and wheel roughness, impact noise resulting from rail and wheel imperfections and joints, and noise resulting from short-pitch rail corrugation are normally associated with tangent track noise. Curving noise primarily involves wheel squeal and, perhaps, wheel howl, in addition to rolling noise. The discussions concerning tangent track noise should be referred to when dealing with rolling noise at curved track. Noise from special trackwork includes impact noise generated by wheels traversing gaps in trackwork components, specifically switch frogs and crossovers, and the associated treatments include special trackwork components that minimize this type of noise.

The first step in selecting noise control treatments is to identify the type of noise by the measurement of noise levels, spectral analysis, observation, and listening. For example, there should be no difficulty distinguishing between squeal and rolling noise. However, distinguishing between wheel howl and corrugated track noise may be very difficult without inspecting the track to determine whether corrugation is present. Similarly, abnormally high rolling noise may be difficult to identify without assessing wheel and rail condition; rough wheels or rails directly produce high levels of noise. Once the particular type of track and associated noise

are identified, the user may concentrate on the options listed under the general headings of onboard, trackwork, and wayside treatments, which are discussed and compared in tables. Detailed discussions of onboard, trackwork, and wayside treatment options are provided in later chapters.

Any treatment selected for noise control should be carefully reviewed by the transit system engineering staff for cost, practicality, and safety. Further, for noise control treatments that have not received widespread application in the United States, or treatments involving custom fabrication or modification of vehicles, prototype tests should be conducted to better determine actual noise reductions which may be reasonably expected and to identify limitations in application.

Representative order of magnitude costs are provided for a comparison of various noise control treatments. These costs are listed to aid in the selection process, and the user should verify costs with suppliers and contractors before selecting or rejecting a treatment. Further, non-noise related costs of the treatment should be considered as well, because there may be ancillary benefits which may mitigate the cost of the treatment. The estimated costs are not vendor or contractor bid prices; actual prices must be obtained directly from suppliers.

5.2 TANGENT TRACK NOISE

Tangent track noise includes (1) normal rolling noise, (2) excessive rolling noise, (3) impact noise, and (4) corrugated rail noise. The selection of a noise control treatment depends on the type of noise. For example, damped wheels are effective in controlling squeal, but historically have produced little reduction of tangent track rolling noise at U.S. transit systems. As another example, *normal* rolling noise at tangent track would not be reduced significantly by rail grinding or wheel truing because the rails and wheels already would be in good condition (though some minor noise reduction might still be expected). Therefore, the user must identify the type of noise before deciding on a treatment scenario.

5.2.1 Normal Rolling Noise

Normal rolling noise occurs for smooth ground rail with optimum rail and wheel profiles. The rail will appear smooth and free of spalls, pits, shelling, and corrugation. The con-

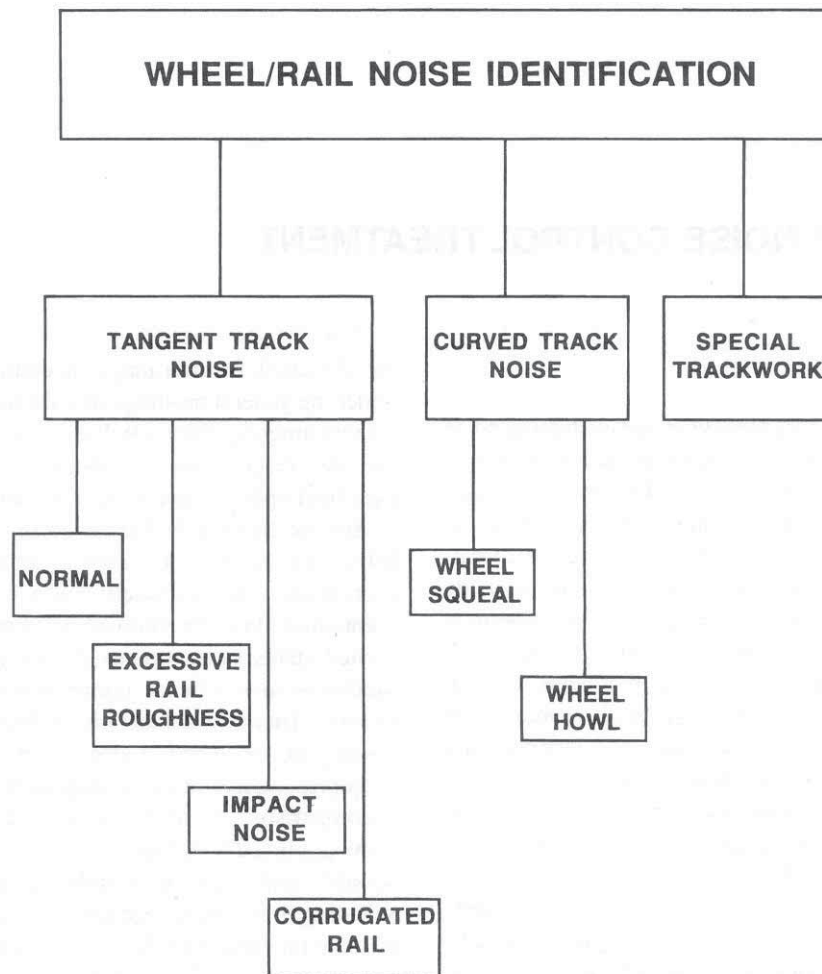

FIGURE 5-1 CATEGORIZATION OF WHEEL/RAIL NOISE

tact patch width will be uniform in width, without plastic flow at the edges, and will be about $\frac{1}{2}$ to $\frac{3}{4}$ in. A straight-edge placed longitudinally along the rail running surface will indicate a uniform rail height profile when backlit. There should be a minimum of flange contact with the gauge face, and there should be no two-point contact wear patterns on the rail head. The contact wear strip ideally should be centered on the rail head, over the stem, or, at most, centered $\frac{1}{2}$ in. to either side of the rail center if variation of contact location is desired to avoid tread rutting. The ball of the rail should be radiused, and the wear pattern should not encounter the edge of the radiused portion of the ball. The wheel tread will be smooth, without pits, spalls, polygonalization, or other imperfections, and the tread profile will not be worn significantly.

The maximum passby level generally will be consistent with the maximum A-weighted noise levels indicated in Figure 5-2. The levels shown are for eight-car rapid transit trains, such as those at BART and WMATA, with solid steel or aluminum centered wheels; lower levels of noise may be

expected with shorter trains. The passby noise will appear to be uniform from one vehicle to the next and will not exhibit harsh pure tones or “roar” resulting from corrugation or other imperfections. The passby noise level signature will vary smoothly with time, with each wheel set contributing a similar amount of noise energy. In contrast, a single flatted wheel will produce as much as a 7 to 10 dB higher noise level in the open on at-grade or aerial structure track than each of the remaining wheels and will be clearly identifiable during passage. Rail grinding and wheel truing will not greatly reduce normal rolling noise levels because the running condition of the rail and wheels already should be good. There may be some optimization of rail head contour and wheel profile that may reduce noise, but this likely will be limited to a few decibels or less.

Table 5-1 lists various options available for controlling normal rolling noise. Expected noise reductions, costs, and site-specific limitations also are listed. The options available for noise control are not extensive and are primarily concentrated in the area of wayside and onboard applications.

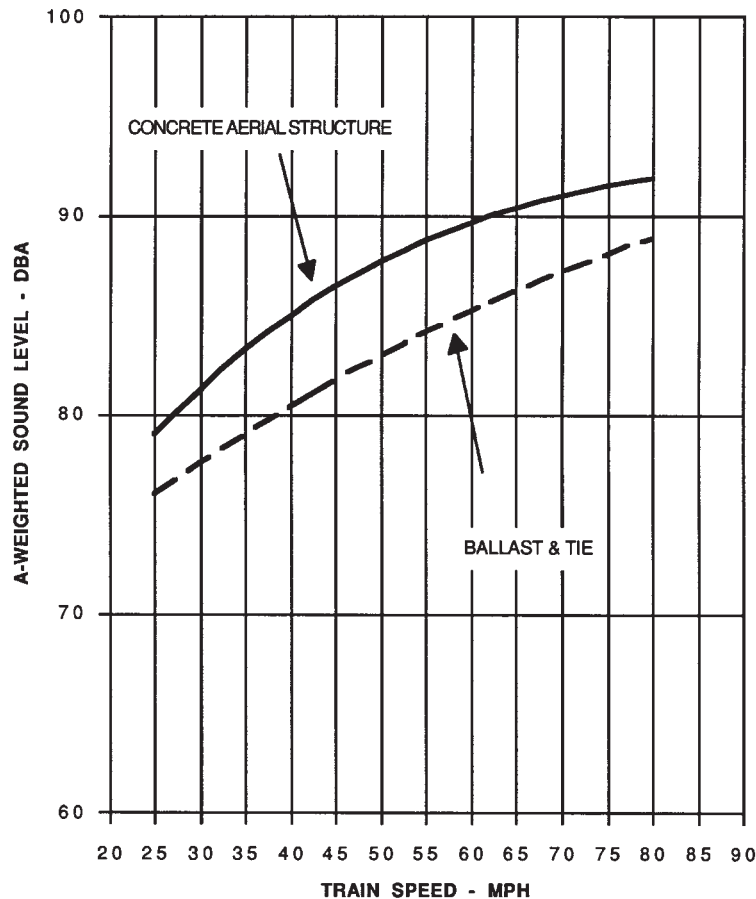

FIGURE 5-2 MAXIMUM PASSBY LEVELS FOR 8-CAR TRAIN AT 50 FEET FROM TRACK CENTER WITH GROUND RAIL AND TRUED WHEELS

5.2.1.1 Onboard Treatments

The onboard treatment options available for controlling normal rolling noise are limited primarily to vehicle skirts, undercar sound absorption, enhancement of car body sound transmission loss, and, to a lesser extent, resilient wheels, though the latter option's noise reduction is limited to 1 to 2 dB. Damped wheels are not considered to be effective because the maximum A-weighted noise reduction observed for typical transit application has been about 0 to 1 dBA. Similarly, although onboard dry-stick lubricants have been promoted by various manufacturers as an effective reducer of rolling noise, data collected at BART do not demonstrate this and thus are not included here.

Vehicle Skirts. Vehicle skirts located about the trucks may reduce wayside noise by up to 2 dB if combined with sound absorption treatment applied to the interior surfaces of the skirts. The skirts must deflect and absorb wheel radiated noise and may be most effective in controlling squeal as opposed to rolling noise. Skirts should be less effective on ballast-and-tie track than on direct fixation track because of the absorption

provided by the ballast. Skirts are likely to be ineffective in reducing noise radiated by the rails. Costs for skirts are estimated to be between \$5,000 and \$10,000 per vehicle. Limitations of vehicle skirts concern clearance for the third rail, and there may be an impact on vehicle maintenance because they limit access to the area of the truck. Systems currently using skirts include the Denver and Portland light rail systems, the latter with the procurement of low floor height vehicles. Vehicle skirts would be effective systemwide.

Undercar Absorption. Undercar sound absorption may yield limited interior and exterior noise reductions, on the order of 2 to 3 dB, if applied to the underside of the floor over the truck. Attractive features of undercar sound absorption are the fact that (1) it is reasonably inexpensive and (2) it would be effective systemwide. However, there may not be sufficient free area under the car to treat, and the treatment may interfere with vehicle maintenance. Costs for treatment are estimated to be about \$10 per square foot, or about \$3,500 per vehicle, if 50% of the entire underside of the floor is treated. These costs could be considerably higher if installation is difficult or if complex attachment and retention methods are required.

TABLE 5-1 NOISE CONTROL OPTIONS FOR NORMAL ROLLING NOISE AT TANGENT TRACK

LOCATION	TREATMENT OPTION	NOISE REDUCTION - dB -	COST	SITE SPECIFIC LIMITATIONS
Onboard	Undercar Absorption	3	\$3,500/vehicle	May not be effective for ballasted track
	Resilient Wheels	1 to 2	\$2,400 to \$3,000/wheel	May not be appropriate for tread braked systems
	Skirts	1 to 2	\$5,000 to \$10,000 per vehicle	Third rail clearance. Should be combined with undercar sound absorption
	Undercar sound absorption	2 to 3	\$3,500/vehicle	Applicable to interior noise. Application will be limited by undercar equipment, but should be provided over trucks
	Car Body Insulation	0 to 5 dB	Original equipment	Includes floors, windows, door seals. No site-specific limitations
Trackwork	Trackbed Absorption	5	\$10/sf	Ineffective for ballasted track
	Between track barriers	3 to 5	\$50 to \$100/tr-ft	Must be combined with train-way ceiling absorption
	Rail Vibration Absorbers	1 to 2	\$500/ft	Requires clearance between rail and invert. Concern over falling from aerial structures.
Wayside	Sound Barriers	5 to 10	\$15 - \$20/sf	Adverse topography. May be adverse visual characteristics
	Absorptive Barriers	7 to 12	\$25/sf	Less effective for ballast and tie track
	Earth Berms	7 to 12	Site dependent	Attractive for landscaping.
	Depressed Grade	5 to 10	Site dependent	
	Receiver Treatment	0 to 10	\$5,000 to \$10,000/receiver	May require forced ventilation. May encounter structural deficiencies, code violations, and pest damage
	Enclosure	10 dB	Unknown	Impact on fire control, evacuation, and ventilation
	Subway wall treatment	5	\$7-10/sf	
	Station treatment	5 to 10	\$7 to \$10/sf	
	Fan and Vent Shaft acoustical absorption	5 to 15	\$7-10/sf	

Resilient Wheels. Resilient wheels may provide about a 1- to 2-dB reduction in wayside and car interior noise. However, their use would likely be driven by the need to control wheel squeal at curves, where they are most effective. Resilient wheels, as a rule, should not be used solely to control rolling noise. Another benefit of resilient wheels is reduced truck shock loading. Costs for resilient wheels, which vary by manufacturer and by application, range between \$2,000 and \$3,000 per wheel, considerably higher than the cost of about \$400 to \$700 for solid steel wheels.

Car Body Sound Insulation. Car body sound insulation, which is necessary for reducing car interior noise, is normally a provision in standard car procurements. Car body sound insulation is controlled by the car body shell, floor, windows, doors, and connections between the trucks and vehicle body. Effective car body designs include a composite double layer shell and liner with glass fiber sound absorption, a composite floor with a resilient floor covering, acoustically rated glass windows, and effective door seals. Car interior noise control for normal rolling conditions is best achieved by specifying car interior noise levels for new car

procurements. Example specifications are provided in the APTA Design Guidelines. Older vehicles may have to wait for rehabilitation before they can be treated. Shop treatments include repair or replacement of door seals.

5.2.1.2 Trackwork Treatments

Trackwork treatments include sound absorption at the track level, perhaps between the rails; rail vibration absorbers; low-height barriers between tracks; and any other measure for which the track maintenance department would be responsible. A brief discussion of each of these treatments follows, and more detailed discussions are provided in Chapter 8.

Trackbed Absorption. Trackbed absorption is effective for direct fixation track with concrete inverts or slabs, such as at concrete aerial structures. Noise levels at ballast-and-tie track are normally 4 to 5 dB lower than at aerial structure and concrete slab track with direct fixation fasteners, ostensibly because of the sound absorption provided by the ballast. Additional trackbed sound absorption would be ineffective

at ballast-and-tie track. There may be substantial maintenance problems associated with sound absorption treatments positioned beneath the train in exposed situations. Such problems may involve the ability to inspect and maintain track components. Debris may accumulate beneath the absorption, making cleaning of the invert difficult. The treatment would be effective for station platform areas and areas where debris would not accumulate. The absorption must be protected from tunnel washing machines and other maintenance equipment which might otherwise damage the treatment.

Candidate treatments include (1) Tedlar-encased glass-fiber board of density 3 psf, protected by perforated sheet metal or fiber reinforced panels; (2) spray-on cementitious sound absorption; and (3) ballast. In the case of ballast, electrical insulation may be compromised if the ballast extends to the top plate of the fastener. A variant of trackbed absorption is underplatform absorption for stations. There usually is a recess under the platform edge which is called the "suicide pit," and underplatform absorption placed against the far wall of this recess and the underside of the platform overhang provides a particularly effective means for controlling station platform noise levels in subways. This is discussed in greater detail with respect to wayside treatment.

Rail Vibration Absorbers. Rail vibration absorbers are an intriguing noise reduction treatment. Vibration absorbers are spring-mass systems with damping incorporated into the spring to absorb and dissipate vibration energy. They are attached to the rail with clamps, without contacting the invert or ballast. Vibration absorbers may be tuned by the absorber manufacturer to optimize dissipation of rail vibration energy into heat over a particular range of frequencies and may be particularly desirable at locations where a sound barrier would be impractical and the needed noise reduction is on the order of a few decibels. The unit cost for rail vibration absorbers is expected to be on the order of \$50 to \$100 per absorber. Assuming that one absorber is applied in every space between fasteners at both rails, and that the fastener spacing is 30 in., the cost per track foot would be on the order of \$40 to \$80. Placement of absorbers at every other or every third fastener spacing may be possible, and tests should be conducted to determine effectiveness. The rail vibration absorber may be particularly effective in reducing the pinned-pinned mode response of the rail associated with fastener pitch.

Between-Track Barriers. Barriers positioned between tracks can reduce station platform noise levels. Both sides of the barrier should be lined with sound absorbing material, such as 2 in. of glass fiber of weight 3 pcf. Cementitious panels with sound absorbing properties have been proposed. Barrier height should extend to the floor level of the transit vehicle. There is a safety issue concerning entrapment of track inspection personnel or patrons caught in the trainway.

Resilient Rail Fasteners. Resilient fasteners are not normally considered a treatment for wheel/rail noise. They are

designed to reduce low-frequency groundborne or structure-borne noise above about 30 Hz and can be effective in reducing wayside noise radiated from steel elevated structures and aerial structures with steel box girders. Included in this category are the Stedef and Sonnevile twin booted tie systems. Resilient fasteners with elastomer springs have been proposed for reducing wheel/rail noise radiation by using the damping properties of the elastomer. Further, adding bonded resilient fasteners to wood tie elevated structures may reduce secondary impact noise radiation caused by an otherwise loose system consisting of tie plates and cut-spikes. The resilient fasteners provide rail support without looseness and, therefore, may reduce noise related to impact between the rail and tie plate. However, the damping provided by the elastomer may be the principal noise reducing agent, because the tight rail support with damping would be effective in reducing vibration transmission along the rail which otherwise might be free to vibrate. Systems that use concrete ties with spring clips may not benefit from the use of resilient fasteners, because the spring clips already eliminate any looseness between the rail and tie.

5.2.1.3 Wayside Treatments

Wayside treatments for normal rolling noise include sound barriers, absorptive sound barriers, and receiver sound insulation. These are the most effective treatments available for reducing normal rolling noise at wayside receivers. Although not listed, shifting the alignment is always a possibility, though this option is possible primarily for new construction in which such an option can be exercised at the design stage. Alignment shifting is not considered an option for existing systems because of the severe cost and disruption of service. Also included are station and subway treatments for controlling noise received by the transit patron and ventilation and fan shaft treatments for controlling noise radiated to nearby residences. Brief descriptions of these treatments follow; see Chapter 9 for more detailed discussion.

Sound Barrier Walls. Sound barrier walls are the most effective treatment for controlling normal rolling noise in wayside areas. Sound barrier walls may be treated with sound absorbing materials to enhance their effectiveness, though at considerable cost. The site-specific limitations of sound barriers include (1) lack of sufficient access for wayside maintenance vehicles at at-grade track, (2) lack of sufficient distance from track center to guarantee safety of individuals that might be trapped between the track and wall, (3) source and receiver elevations that may not be appropriate for achieving effective noise reduction for a practical barrier height, (4) high sound barriers that may be unattractive or undesirable, and (5) high wind loads, steep grades, and poor soils that may require substantial foundations. The cost of a typical sound barrier wall in 1994 was about \$15 to \$20 per square foot, though costs as high as \$40 per square foot have been encountered for masonry walls. Thus, a typical 8-ft-high sound barrier wall could cost about \$160 per lineal foot

of track. There may be additional costs for landscaping, maintenance, and additional architectural features. Where transit systems pass through residential neighborhoods within 35 ft of residential structures, center barriers may be useful to control far-track noise at second-story receivers. Assuming that a center barrier would be about 6 ft high, the cost may be about \$120 per lineal foot, bringing the total cost for barriers to \$280 per track foot. Barrier costs may vary considerably from one locale to another and may be driven by aesthetic considerations and topography; therefore, barrier costs could be as high as \$40 per square foot when landscaping and drainage are included. Nevertheless, sound barriers can provide a visual as well as physical separation between a wayside residential community and a transit corridor, which may be highly desirable to the community.

Berms. Berms are another form of sound barrier which are visually attractive, provide a safety barrier against derailment, and are believed to offer more noise reduction than a simple nonabsorptive solid wall of the same height. Berms can be attractively landscaped to add a natural look to the ground between source and receiver. Reinforcement can be incorporated into the berm to allow high aspect ratios where insufficient space exists for the customary 1 in 2 slope of the berm.

Absorptive Sound Barriers. The track side of sound barrier walls may be treated with sound absorbing materials to improve barrier performance and reduce or eliminate reflections. Absorptive sound barriers are most effective at concrete invert track with direct fixation; the noise reduction obtained at ballast-and-tie track may be limited by the existing absorption provided by the ballast if the barrier is close to the vehicle. A careful analysis should be performed to determine actual effectiveness, and prototype testing is desirable. There are two conditions to consider: (1) a barrier at a large distance from the track and (2) a barrier very close to the track.

In the first case, sound absorption is expected to improve the insertion loss of simple barriers, though the improvement may be limited to 2 to 3 dB. In the second case, multiple reflections between the barrier face and vehicle body will degrade barrier insertion loss. Sound absorbing material applied to the face of the barrier facing the train will reduce or eliminate multiple reflections and improve barrier performance. Such treatment is particularly attractive for bridges, viaducts, and aerial structures where barrier weight is a critical design factor and where structures with direct fixation track would otherwise provide little sound absorption.

Absorptive barriers may be useful in situations in which high barriers are needed on either side of the track or tracks and where there is a need to reduce the reflection of sound from the more distant barrier. Sound absorption applied to the face of the barrier would cost about \$10 per square foot, which is added to the initial cost for the barrier of about \$15 to \$20 per square foot. Savings can be obtained for absorptive barriers constructed of sheet metal and 4 in. of glass fiber, powder coated to provide an attractive finish and protection against the weather and oxidation. An advantage of

the sheet metal barrier is its low weight, which may be attractive for bridges and aerial structures. A "living wall," a type of retained earth barrier with very steep or vertical sides which support plant growth, may be attractive. Only the upper 3 to 5 ft of the barrier may need to be treated if reflections are not of concern. A variant of this approach is the addition of an absorptive crown to the barrier, which would increase barrier height, though less than that required for a nonabsorptive barrier. Examples of this last approach have been used in Japan.

Aerial Structure Barriers. Barriers are commonly mounted on the edge of aerial structures just outside the dynamic clearance envelope of the train. Examples of such installations include those at BART and WMATA. The height of the barrier may be limited to that of the vehicle floor to allow passenger rescue over the top of the barrier. The barrier may be treated with spray-on cementitious sound absorption materials to enhance the performance of the wall. The expected noise reduction typically is 7 to 10 dB, especially if the space between the track can be closed off, making the absorptive barrier one of the most effective treatments available for controlling wayside noise. Addition of a center barrier would further reduce noise from far-track trains, though such a use may be prevented if a center walkway is needed or if entrapment is a problem. A center wall is not normally employed on double track aerial structures.

Enclosures. Aerial structure track has been enclosed to reduce wayside noise in Hong Kong. This approach requires consideration of fire control, evacuation, and ventilation, as with any subway. Costs for track enclosures are not known, but are likely to be substantial. Sound absorption can be applied to the interior surfaces of the enclosure to further reduce wayside noise and to reduce car interior noise. Sound absorption would be particularly important if there are substantial openings in the enclosure and in the aerial structure between the tracks.

Depressed Grade or Open Cut. Depression of the track in an open cut provides significant noise reduction in a manner analogous to that of high barriers on either side of the track. Treating the walls of the open cut with sound absorbing material is very beneficial in reducing or eliminating multiple reflections, particularly for elevated receivers which may look down on the open cut. Without sound absorption, the sound eventually would be radiated upward and away, possibly toward sensitive receivers. Ballasted track in open cuts produce lower noise levels than direct fixation track, thus reducing the need for additional absorption on the walls of the cut. Costs for open cuts relative to at-grade track have not been determined. Use of an open cut may be driven by the desirability of a grade separation for traffic flow or aesthetic considerations.

Station Treatment. Station treatment includes application of sound absorption to underplatform surfaces, station ceil-

ings, and station walls. Effective underplatform treatments include spray-on cementitious sound absorbing materials and 3-pcf glass fiber encased in 3-mil-thick Tedlar plastic and perforated fiber reinforced plastic sheet or sheet metal. The rear walls of suicide pits and the underside of the platform can be treated, producing very effective results. Station walls and ceilings may be treated with acoustical ceiling panels, subject to provisions for air pressure transient loading. In the trainway, ceiling and wall treatments should be mounted flush against the ceiling without air gap to avoid stresses induced by dynamic air pressure loading or buffeting as the train enters and leaves the station. Ceilings and walls also may be treated with spray-on cementitious sound absorbing materials. The spray-on cementitious treatments can be applied in an architecturally appealing manner, and substantial experience has been gained with the application of these treatments. Costs for station treatment are difficult to assess, but are likely to be on the order of \$7 to \$10 per square foot, depending on labor rates.

Subway Wall Treatment. In subways with direct fixation track, treating the upper half of the subway walls and the entire ceiling with sound absorbing materials will reduce car interior noise. The treatment is especially desirable where vehicle windows are often left open for ventilation or where there is substantial sound transmission through the car body or doors. Subway wall treatments also reduce station platform noise levels caused by approaching trains and subway ventilation fans. Ballast provides substantial sound absorption; therefore, the addition of tunnel wall and ceiling absorption in tunnels with ballasted track will have much less effect than in tunnels with direct fixation track. An example of extensive tunnel wall treatment with cementitious sound absorption includes the MBTA.

Subway wall treatments consisting of spray-on cementitious sound absorbing treatment are practical and effective. Alternative treatments include 3-pcf glass-fiber board protected by a 3-mil-thick plastic film with a perforated sheet metal or fiberboard cover. Sound absorbing porous glass blocks also have been used, though these tend to be more costly than cementitious absorption and are difficult to procure. Costs for subway wall treatment with cementitious spray-on treatments are on the order of \$7 to \$10 per square foot. Treatments with 3-pcf glass fiber may be on the order of \$10 per square foot, and encasement in Tedlar and perforated sheet metal facings will increase the cost. Cost estimates should be obtained and carefully reviewed.

Fan and Vent Shaft Treatment. Wheel/rail noise emanating from fan and vent shafts in normally quiet residential areas can be controlled with sound absorbing materials applied to the walls and ceilings of the shafts. For fan shafts, in-line sound attenuators may be employed to reduce both train and fan noise, the latter being the most objectionable. Effective treatments include 1-in.-thick, spray-on cementitious sound absorption material, sound absorbing porous glass foam block, and 1-in.-thick, 3-pcf glass-fiber board with perforated cover. Typical costs for treatment are about

\$10 per square foot. Details of shaft treatment are provided in Chapter 9.

Receiver Treatments. Receiver treatments include replacement of single pane fenestration with acoustically rated fenestration, weather stripping, and provision of forced air ventilation. Receiver treatments may not be practical if the structure is already weatherproofed and has thermally insulating glass. The building construction should be inspected to determine if there would be any benefit achieved by treating a receiver directly. Treating a residence, which involves the residents in the design process, may require relocation of the residents during treatment. Further, receiver treatments may involve bringing an existing structure up to local code requirements or may require replacement of pest damaged portions of the structure. Receiver treatments do not reduce exterior noise, where residents may spend varying amounts of time. Thus, receiver treatments are best avoided if a sound barrier or other treatment can be employed successfully. Treatment of upper story receivers may still be necessary near track where sound barriers would otherwise be unreasonably high. Thus, a transit system designer may explore a combination of barrier and receiver treatments to optimize overall performance and cost.

5.2.2 Excessive Rolling Noise

Excessive rolling noise resulting from random roughness is caused by rough rails and wheels, but the rail is without identifiable rail corrugation, joints, or other large imperfections in the running surface. Excessive rolling noise would normally arise after a period of no rail grinding or wheel truing, and rail condition should be visibly deteriorated with pits, fatigue cracking, and gauge corner metal plastic flow. Excessive rolling noise may occur without obvious visible defects, resulting simply from high amplitude random roughness, flat rail head, improper cant, and rail grinding pattern. Excessive rolling noise also may exist despite rail grinding, where the rail grinding is minimal or does not provide a smooth, uniform contact wear pattern edge definition.

Candidate treatments for controlling excessive rolling noise are listed in Table 5-2. Discussion of these treatments with respect to onboard, trackwork, and wayside application follows. All of the treatments for normal rolling noise are applicable to excessive rolling noise, though treatments for normal rolling noise usually should not be applied unless needed after the treatments identified in Table 5-2 are considered. The treatments listed in the table are effective, particularly against the wheel and rail conditions which produce excessive noise, and should be explored before resorting to treatments for normal rolling noise.

5.2.2.1 Trackwork Treatments

The principal trackwork treatment for excessive rolling noise is rail grinding. The trackwork treatments indicated for treating normal rolling noise also are applicable, but should be considered only after grinding the rail.

TABLE 5-2 NOISE CONTROL TREATMENTS FOR EXCESSIVE ROLLING NOISE WITHOUT CORRUGATION

TREATMENT LOCATION	TYPE OF TREATMENT	NOISE REDUCTION (dB)	PROBABLE COST	COMMENTS
Trackwork	Rail Grinding (In combination with wheel truing)	7 to 10	\$5/trk-ft/yr ¹	
	Defect Welding and Grinding	5	\$200/defect	
	Joint Maintenance and tightening	5	\$6/joint/yr ¹	
	Joint Welding	5	\$600/joint ¹	
	Bonded elastomer resilient rail fasteners	5 to 10	\$50/fastener	Reduces structure radiated noise and impact noise generated by loose fixation
Treatments listed above for normal rolling noise control				
Onboard	Wheel truing (in combination with rail grinding)	7 to 10	\$60/wheelset ¹	Cost of wheel truing machine is \$600,000 to \$1,200,000
	Slip-slide control		\$5,000-\$10,000 /vehicle ²	Reduces incidence of flats
Treatments listed for normal rolling noise				
Wayside	Treatments listed for controlling normal rolling noise			

¹ L.R. Kurzweil et al., *Noise Assessment and Abatement in Rapid Transit Systems* (1974) pg. 3-10

² Recent bid spreads for retrofit at rail transit systems

Rail Grinding. Rail grinding in combination with wheel truing is the most effective means of controlling noise caused by excessive rail roughness. Rail grinding should be optimized to reduce fatigue and wear of the running surface, which would lead to excessive roughness and noise. There is disagreement in the literature concerning the best profile for obtaining the least noise. Widening the contact patch has been conjectured to reduce net contact dynamic forces by averaging the rail and wheel roughness over the contact patch area. On the other hand, increased rail conformity increases spin-creep, possibly contributing to rail corrugation, wear, and, thus, noise. At present, "squaring up" the contact patch appears to be a reasonable approach for controlling wayside noise, subject to further study.

Increased conformity resulting from wheel tread wear can be controlled with wheel truing. If wheel truing is insufficiently frequent such that concavity is prevalent in the tread profile, there may be other problems besides spin-creep, such as poor ride quality and steering. In all cases, the track should be ground and the wheels trued to prevent two-point contact on the running surface of the rail. Rail grinding may actually increase wheel/rail noise if grinding introduces a periodic grinding pattern in the rail head, a condition which should be avoided, because there is no guarantee that the pattern will be entirely worn away with time. Visual evidence of the grinding pattern may disappear with time, but undulation and residual hardness variation may persist.

Grinding equipment must be selected and maintained in good condition to avoid tool chatter and debris accumulation

in the grinding wheels, which can lead to excessively deep grinding patterns. The wavelength or pitch of any grinding pattern should be reduced to less than the contact patch longitudinal dimension by reducing grinding train speed. Patterns in narrow ($1/16$ to $1/8$ in. wide) grinding facets, produced by multiple stone grinders and multiple passes to shape the head, will be averaged over the contact width, thus reducing noise. Wide grinding facets, on the other hand, will prevent such averaging. Site-specific limitations for rail grinding include (1) lack of clearance in tunnels for the grinding machine, (2) lack of track access because of conflict with revenue operation, and (3) inability to grind certain kinds of track, such as embedded curves.

5.2.2.2 Onboard Treatments

Wheel truing, the principal onboard treatment for controlling excessive rolling noise, should be considered before resorting to treatments identified for normal rolling noise.

Wheel Truing. Wheel truing, the most effective onboard treatment for controlling excessive rolling noise caused by wheel roughness, may be considered a necessary part of a vehicle maintenance program. Systems which do not have effective wheel truing programs probably experience abnormally high rolling noise. Current information indicates that there is little difference between the type of wheel truing machine used (e.g., milling or lathe) and the resulting noise level.

Noise reductions on the order 7 to 10 dB may be expected for initially rough wheels if the rail also is ground, though actual noise reductions will depend on the state of roughness of both the rails and wheels. Truing severely polygonalized wheels or wheels with extensive and severe wheel flats may result in much greater rolling noise reductions. Wheel truing without an effective rail grinding program may not achieve the lowest noise levels possible, because a rough or severely corrugated rail may partially or completely mask the noise control benefits of wheel truing. However, even without rail grinding, wheel truing will help maintain a quiet system and should be performed.

There are no apparent site-specific limitations for wheel truing, other than availability of facilities. Some transit engineers have expressed a concern over the ability to true resilient wheels, which suggests that the wheel truing machine manufacturer should warrant that its equipment is capable of truing resilient wheels. However, transit systems such as the Portland Tri-Met and Los Angeles Blue Line regularly true resilient wheels with no reported difficulty.

The cost of wheel truing includes the cost of the wheel truing machine and its maintenance, materials such as cutting tools, and labor. The cost of a typical truing machine is on the order of \$1 million, with the milling type of machine being the less expensive (and less accurate) than the lathe type. Selection of a wheel truing machine is important. Monomotor trucks do not allow slip between front and rear axles; therefore, wheel diameters must be maintained to close tolerances. The truing tolerance of milling- and lathe-type truing machines should be carefully reviewed before selection if monomotor trucks are involved.

Another consideration is the amount of tread metal removal required to clean up the flange. BART has indicated informally that the milling machine requires more metal removal per truing operation than the lathe machine. Thus, the upfront cost savings realized by purchasing a milling machine instead of a lathe machine may be more than canceled by additional costs for wheel replacement. Metal removal and overall operating costs savings should be carefully reviewed with the truing machine manufacturer before selecting a particular machine. Finally, the wheel truing machine operator should be a qualified machinist capable of precise milling and cutting operations, and willing to focus on the truing process.

5.2.2.3 Wayside Treatments

Wayside treatments for controlling normal rolling noise also are effective in controlling excessive rolling noise. Where rail grinding cannot be performed because of (1) geometric limitations, (2) an inadequate grinding budget, or (3) lack of equipment, the remaining choices may be provision of a sound barrier wall or berm, receiver treatment with acoustically rated windows and provision of forced air ventilation, or enclosure of the track. These treatments are likely to be more costly than

procurement of necessary rail grinding and wheel truing equipment if a large number of wayside receivers are involved. Further, more expensive wayside treatments generally would be required without rail grinding and wheel truing than if rails and wheels are maintained in good condition.

5.2.3 Impact Noise Control

Impact noise may be the most significant source of noise at transit systems where rail grinding and wheel truing are not performed or are performed on an infrequent basis. The causes of impact noise include chips, spalls, burns, rail joints, and excessive curvature of the rail surface in the longitudinal direction. These causes are described in Chapter 4. Remedies for impact noise follow. A summary of impact noise control treatments is presented in Table 5–3. These treatments are applicable to rolling noise at both tangent and curved track. Treatments for impact noise caused by special trackwork are discussed in a separate section that follows.

5.2.3.1 Trackwork Treatments

Treatments for impact noise include rail grinding, defect welding and grinding, joint maintenance, field welding of joints, and elimination of loose track supports. These should be considered before resorting to trackwork treatments identified for normal rolling noise.

Rail Grinding. Rail grinding is by far the most effective means of controlling impact noise caused by rail defects. The rail grinding machine should be able to control rail height uniformity over a length of about 6 ft to eliminate impact noise caused by excessive rail height curvature in the longitudinal direction. The horizontal axis single-stone grinder may not be appropriate for controlling rail height curvature unless provision is made for controlling stone height relative to reference points before and after the stone. The grinder should remove enough metal to eliminate fatigue cracks, pits, spalls, chips, and burns. Overgrinding may be desirable to reduce stress concentrations and hardness variation. After an initial deep grind to remove defects, the rail head should be recontoured to maintain proper contact patch width and location. After this process is complete, the rail should be regularly ground to maintain a smooth running surface.

Defect Welding and Grinding. This procedure involves deposition of weldment to an engine burn, using an electric arc, and grinding the weldment to achieve a smooth running surface. Field welding costs are estimated to be \$200 per defect, assuming 2 hours per defect with two track maintenance workers at \$50 per hour. Site-specific limitations may involve weldability of alloy steels and track access. The rails should be inspected before treatment to determine if other more serious defects exist, such as fatigue fracture of the body of the rail, in which case rail replacement may be the

TABLE 5-3 TREATMENTS FOR IMPACT NOISE DUE TO RAIL DEFECTS

TREATMENT LOCATION	TYPE	NOISE RED'N - dBA -	COST - \$ -	COMMENT
Trackwork	Rail Grinding	7 to 10	\$1,000 to \$7,000/track-mile	Must be done in conjunction with wheel truing. Cost based on labor and overhead for 2 persons at \$2,000/day and grinding 2 miles of track per shift. Costs vary substantially.
	Defect welding and grinding	0 to 3	\$200/defect	Noise reductions depend on number of defects. Costs are subject to local labor rates and field conditions.
	Joint Maintenance	2 to 3	\$200 to 400/joint	Primarily relevant to older transit systems with steel elevated structures.
	Field welding of joints	5	\$600/joint	Ancillary cost benefits in reduced maintenance.
	Eliminate rail support looseness	5	\$66 to \$100/tr-ft	Achieved with resilient direct fixation fasteners or concrete ties with spring clips. Primarily relevant to steel elevated aerial structures.
Onboard	Wheel truing	7 to 10	\$60/wheelset ¹	Single most important treatment, because wheel flats are most significant cause of impact noise.
	Slip-slide control	7 to 10	\$5,000 to \$10,000/vehicle	Reduces flat occurrence by about 50%, and thus reduces wheel truing costs proportionately.
Wayside	Treatments for normal and excessive rolling noise			

¹ L. G. Kurzweil et al., *Noise Assessment and Abatement in Rapid Transit Systems* (1974).

best choice. Chips and spalls should be ground out without welding by moving the contact strip and cleaning up the defect. If the chips and spalls are not too deep, they may be taken out by a thorough grinding of the rail with a rail grinding train as discussed previously.

Joint Maintenance. Impact noise is generated at rail joint gaps and elevation discontinuities. Large joint gaps create more noise than short joint gaps. Misalignment of the running surface elevation will result in impact noise. Further, the ends of the rail may require weldment deposition and grinding to repair end-batter. Thus, joint maintenance includes tightening rail joints to remove or reduce gaps, aligning running surface elevations, and repairing battered ends. Properly tightened joints and tie plates will reduce impact noise to manageable levels. The cost of joint maintenance is roughly \$5 to \$10 per foot without welding, based on data collected in 1980 and adjusted for producer price index changes.

Field Welding of Joints. Field welding of joints, or replacement of the rail with continuous welded rail, eliminates impact noise at joints and results in an overall reduction of maintenance effort. Field welding, or use of continuous welded rail, may not be practical on aerial structures, where thermal expansion and contraction may place high loads on aerial structure components. Examples include the MTA NYCT steel elevated structures, some of which may be more than 100 years old. Modern reinforced concrete aerial structures normally are capable of carrying continuous welded rail, though provisions are made in fastener design to accommodate thermal expansion and contraction. The cost

of field welding of joints is about \$600 per joint, based on data collected in 1980 and subsequent changes in the producer price index. After welding, the weldment must be ground to provide a uniform rail height across the joint.

Elimination of Track Support Looseness. Standard wood ties and tie plates retained with cut spikes allow vertical looseness which may promote impact noise caused by hammering of the rail and tie plate. This may be particularly significant at steel elevated structures such as at MTA NYCT and CTA, where impact forces generate vibration in the steel structure, which then radiates noise to the wayside. Replacement of tie plates with bonded resilient fasteners eliminates impact noise between these loose components, and the elastomer fasteners add damping to the rail which helps to reduce the effective noise-radiating length of the rail and, thus, noise. Resilient fasteners also may help to reduce noise radiated by steel box girders supporting aerial structures or noise from older steel elevated structures. Tests at MTA NYCT indicate that the greatest noise reductions were achieved with natural rubber fasteners with stiffness on the order of 100,000 lb/in. and less, lateral stiffness measured at the top plate of between 30,000 and 60,000 lb/in., and top plate resonance in excess of 800 Hz. Resilient fasteners with very low lateral compliance are less desirable than those which provide some isolation. Costs for bonded resilient fasteners are in the range of \$50 to \$80 per fastener, which, for an 18-in. tie spacing on an elevated structure, translates to \$66 to \$100 per track foot. Fastener manufacturing is very competitive; therefore, costs for a specific design characteristic vary little from one manufacturer to the next.

5.2.3.2 Onboard Treatments

Wheel truing and slip-slide control are the principal onboard treatments available for controlling impact noise, and these should be considered before employing treatments identified for normal rolling noise.

Wheel Truing. As with rail grinding, wheel truing is the most effective means of controlling impact noise produced by wheel flats, chips, spalls, and other defects in the tread running surface. Noise reductions on the order of 10 dB may be expected where no truing had been performed before, provided that the rail is sufficiently ground and maintained. There also is an improvement in the qualitative perception of the noise. After truing, and assuming the rail is smoothly ground with no defects or joints, the wheel/rail noise should have the sound of a smooth running bearing, without harshness or audible impacts. In fact, there may be some difficulty distinguishing between wheel/rail noise and propulsion system noise.

Slip-Slide Control. Slip-slide control, standard on most new transit vehicles, is an electromechanical servo-controlled system which limits wheel slip during acceleration and sliding during braking and reduces the occurrence of wheel flats and burns. Braking pressures and motor torques are modulated to equilibrate wheel set rotational velocities. Wheel flats will still occur with a slip-slide system; thus the need for wheel truing is not eliminated. However, the truing interval can be lengthened, and lengthening the truing interval reduces truing costs. Roughly, a 50% reduction of wheel flat occurrence may be expected under normal conditions, which would translate into a 50% reduction of wheel truing periodic costs. Further, slip-slide control improves traction and braking during wet weather, providing ancillary benefits in addition to noise control which might justify its cost regardless of noise reduction benefits. The cost of slip-slide control is difficult to determine because many vehicles come standard with such control, but should range between \$5,000 and \$10,000 per vehicle. The cost should be balanced against the savings in reduced wheel truing and extended wheel life.

5.2.3.3 Wayside Treatments

Wayside noise control treatments identified previously with respect to normal rolling noise are effective for controlling impact noise. However, the trackwork and onboard treatments normally should be considered before engaging in wayside treatments. Only if normal rolling noise levels are in excess of criteria should barriers be considered as a noise control treatment. An exception to this might be a situation in which for reasons of geometry, clearance, or lack of funds, rail grinding and wheel truing cannot be performed.

5.2.4 Corrugated Rail Noise

Noise caused by rail corrugation is perhaps the most objectionable type of wheel/rail noise occurring at tangent or mod-

erately curved track, and one of the most difficult to control. The harsh tonal character of corrugation noise makes it one of the most easily heard and identifiable types of community noise, often affecting large areas. Rail corrugation noise can be painful to transit system patrons and interferes with conversation, and many complaints concerning excessive noise from rail transit systems are directly related to rail corrugation. Descriptive terms for noise caused by rail corrugation are “roaring rail” or “wheel/rail howl.” Roaring rail or wheel/rail howl at severely corrugated track may be a special type of periodic impact noise resulting from loss of contact between the wheel and rail. An inspection of the theory of impact-generated noise for smooth rail undulations reveals that typical corrugation amplitudes are sufficient to produce contact separation.

The noise control provisions appropriate for corrugated rail noise are presented in Table 5-4. Again, rail grinding is the most effective method of treating the symptoms of rail corrugation, but it may not remove the conditions which lead to or promote corrugation. Many other treatments for which there is insufficient information concerning effectiveness are indicated, and they are included for consideration and further evaluation by the user.

5.2.4.1 Trackwork Treatments

Treatments for rail corrugation are limited primarily to aggressive rail grinding. A second direct treatment is hard-facing. Additional trackwork design provisions, subject to field evaluation, which might be effective in controlling rail corrugation include reduced track support stiffness, reduced rail support separation or pitch, stiffened top plate, and vibration absorbers.

Aggressive Rail Grinding. The most effective approach to controlling recurrent or chronic rail corrugation is to grind the rail running surface, using an aggressive rail grinding program optimized to minimize long-term material loss and cost. Assuming that the corrugation growth rate is exponential, at least during the early stages of corrugation when the amplitude is not sufficient to produce contact patch separation, and that sufficient metal is removed to eliminate corrugation without overgrinding, an optimum grinding interval can be approximated as the time interval required for corrugation to grow by about 170% (based on an exponential growth rate). Both longer and shorter grinding intervals will result in higher rates of metal removal and thus reduced rail life. A longer grinding interval will increase noise exposure; a shorter grinding interval will maintain lower levels of noise, but increase grinding costs.

The corrugation growth time may not be sufficient for significant corrugation to appear after rail grinding, and once corrugation amplitudes develop to a point that corrugation noise is audible, the corrugation growth may already exceed the above criterion. In this regard, the rail should be ground often enough to avoid visible corrugation growth in excess

TABLE 5-4 TREATMENTS FOR NOISE DUE TO RAIL CORRUGATION

TREATMENT LOCATION	TYPE	NOISE RED'N - dB -	COST	COMMENT
Onboard	Wheel truing	NA	\$60 /wheelset ¹	Believed to reduce spin-slip corrugation at Vancouver
	Friction modifier	NA	\$1,400 /veh/yr ²	Believed to be effective at Vancouver, but data inconclusive. Costs based on two axles treated per vehicle.
	Damped Wheels	NA	\$500 /wheel ²	Effectiveness unknown, but should be effective to extent that wheel resonances influence corrugation. Little direct reduction of wheel/rail noise.
	Conical Treads	NA	\$0	Effectiveness Unknown, but promotes steering without lateral slip on tangent track.
Trackwork	Aggressive Rail Grinding	7 - 10	\$1,000 to \$7,000 /track-mile	Definitely very effective in reducing noise and controlling corrugation. Cost based on labor and overhead for 2 persons at \$2,000/day and grinding 2 miles of track per shift. Costs vary substantially.
	Reduced rail support stiffness	NA	\$0	Believed to be effective in reducing corrugation rate, but would not reduce noise directly
	Reduced rail support separation to 24 inches	NA	\$50/trk-ft	Unknown effectiveness, but would separate the pinned-pinned mode resonance frequency from the corrugation frequency and thus might reduce corrugation rates.
	Increase top plate bending stiffness	NA	Negligible	Unknown effectiveness, but would avoid coincidence of top plated bending with the pinned-pinned mode rail resonance.
	Hardfacing	7 - 10	\$15/rail-ft	Controls corrugation by providing hard running surface
Wayside	Treatments for normal and excessive rolling noise			

¹ L. G. Kurzweil et al., *Noise Assessment and Abatement in Rapid Transit Systems* (1974) Pg. 3-10.

² Current estimates

NA Not applicable or not available

of random rail roughness and to avoid audible corrugation noise. The optimum grinding interval, thus, is difficult to define, and some experimentation and careful monitoring of growth rates may be required. Profile grinding to minimize spin-creep or spin-slip is employed at the Vancouver Skytrain to reduce rail corrugation. The maximum facet width is $\frac{1}{16}$ in., and several passes are made to produce a radiused ball and limit contact width to the order of $\frac{3}{8}$ in.

Costs for rail grinding include the capital cost of the rail grinder, fuel and grinding materials, and personnel which may involve a grinder operator, flagger, and supervisor. Dust collection equipment in the form of a vehicle-mounted vacuum cleaner also may be needed, producing an additional cost.

Hardfacing. Hardfacing with a very hard rail head inlay has been incorporated at European transit systems to control rail corrugation, especially at light rail or streetcar systems. The effectiveness of the treatment in controlling rail corrugation at U.S. light and heavy rail transit systems has not been demonstrated. Further, the hardfacing material is not recommended by the manufacturer for high carbon steel rail, common in North America. Treatment of short sections subject to unusually severe corrugation may be appropriate, and rails may be supplied with hardfacing. The cost for

hardfacing rail is estimated to be about \$15 to \$36 per lineal foot.

Alloy and Hardened Rail. Alloy rail, such as chromium vanadium, has been considered for controlling corrugation at curves in heavy freight railroads. Its usefulness at transit systems for controlling short-pitch corrugation has not been determined. Alloy rail with greater hardness and wear characteristics might be considered to be less prone to corrugation than standard carbon steel rail, though exactly the opposite has been observed. There may be a reduction of weldability with hardened or alloy steels. Alloy and hardened rail should not be considered for rail corrugation control without careful evaluation and consultation with a metallurgist.

Track Support Stiffness. Rail corrugation growth appears to be most prevalent at stiff direction fixation track where the rail support modulus is in excess of perhaps 10,000 lb/in. per inch of rail, though no clear quantitative relation has been identified between track stiffness and rail corrugation growth. Many other factors must be considered. Anecdotal evidence suggests that a stiffness reduction may be beneficial in reducing corrugation growth rates. With stiff track supports providing a dynamic rail support modulus of about 10,000 to 15,000 lb/in.

per inch of rail, the rail-on-fastener resonance frequency is on the order of 175 to 200 Hz. A fastener consisting of a steel tie plate and thin elastomer pad is very stiff, on the order of 1 to 2 million lb/in., giving a rail support modulus of 30,000 to 60,000 lb/in. per inch of rail. Under these conditions, the vertical rail on fastener resonance frequency is on the order of 350 Hz or higher, at the lower end of the range of corrugation frequencies, suggesting a possible interaction between corrugation and vertical rail resonance.

A benefit of soft rail supports is that the rail is less affected by the fastener pitch, which controls the pinned-pinned resonance frequency of the rail. Another benefit is that at corrugation frequencies, soft fasteners decouple the rail from the concrete invert so that the rail is essentially an infinite beam and, thus, has an input mechanical impedance with equal real and imaginary parts. (The real part is caused by energy transmission along the rail.) Thus, there is a natural damping mechanism that may reduce local resonances in the track and wheels at corrugation frequencies, a mechanism that is negated if the rail support modulus is too high.

Although low stiffness fasteners appear to be attractive, the dynamic interaction between the rail and wheel is very complex, and a careful analysis, testing, and evaluation should be conducted before committing to a wholesale replacement of fasteners to control rail corrugation. Fortunately, BART, WMATA, and the LACMTA have fasteners of widely varying stiffnesses; therefore, answers concerning differences between corrugation growth rates for various fastener stiffnesses should be obtainable by monitoring these systems.

The cost of a soft fastener may range from about \$50 per unit to perhaps \$80 per unit. The cost of a bonded resilient fastener is normally higher than the cost of a fastener consisting of a rolled steel tie plate, neoprene elastomer pad, and clips, a fastener which has a stiffness on the order of 1 to 2 million lb/in., an order of magnitude greater than that of modern bonded direct fixation fasteners.

Rail Support Separation. A fastener spacing of 30 to 36 in. results in a pinned-pinned mode resonance frequency on the order of 500 to 750 Hz, the range of typical corrugation frequencies observed at systems such as BART. There is, therefore, potential for interaction of the pinned-pinned mode with wheel set anti-resonances in this frequency range. Further, corrugation amplitudes have been correlated with fastener location, suggesting that the fastener location does have an effect of some kind. If the pinned-pinned mode is indeed contributing to rail corrugation, a possible solution is to reduce the support spacing and increase the pinned-pinned modal frequency sufficiently so that the associated corrugation wavelength is less than the contact patch longitudinal dimension. In this case, corrugations caused by a pinned-pinned mode might be expected to be "ironed out" or worn away with time.

For 70 mph trains with a contact patch length of $\frac{3}{8}$ in., the design resonance ideally should be higher than 2,000 Hz, suggesting that the fastener separation should be less than 16 in., a separation which would double the cost of current direct fix-

ation fasteners. However, the ironing out effect might be achieved if the associated wavelength is less than half the contact patch length, corresponding to a minimum frequency of about 1,000 Hz and a maximum fastener spacing of 24 in. (The tie spacing of 18 to 24 in. employed at conventional ballast-and-tie track, interestingly, satisfies this criterion.) Finally, increasing the rail section does not appear to greatly increase the pinned-pinned modal frequency for practical rail sections.

Direct Fixation Fastener Top Plate Bending Resonance. The top plate bending resonance frequencies of direct fixation fasteners under load are about 600 Hz, very close to corrugation frequencies for short-pitch corrugation. No clear causative relationship has been identified between rail corrugation and top plate resonance frequency, but prudent design practice would suggest that the resonance frequencies in the track support components be kept away from corrugation frequencies, the first pinned-pinned rail vibration mode, and the first anti-resonance frequency of the wheels. This can be achieved by thickening the top plate to raise its resonance frequency in excess of 1,000 Hz, which requires fasteners that are slightly thicker than what is typical of bonded direct fixation fasteners. A minimum of 2 in. should be provided between the rail base and invert. There should be increased reliability because of the increased strength of the fastener top plate, with less working of the rail clip resulting from top plate flexure under static load. Less working of the clip will result in less fretting corrosion and clip failures. Thickening the top plate will increase the cost of top plate castings, though the increase should be relatively small in comparison with the overall cost of the fastener.

5.2.4.2 Onboard Treatments

Onboard treatments do not reduce noise caused by rail corrugation significantly, but may help to control rail corrugation rates. The onboard treatments that follow are subject to testing and careful analysis; they are not proven approaches to corrugation control. However, to the extent that corrugation is intimately related to vibration and dynamic interaction, the treatments can be expected to influence the corrugation process.

Wheel Profile. The profile of the wheel's running surface directly affects interaction between the rail head and wheel. High wheel/rail conformity has been identified as a contributing factor in rail corrugation at the Vancouver Skytrain, resulting from increased spin-slip (*I*). Frequent wheel truing to maintain a conical tread taper without concavity would reduce wheel/rail conformity and resulting spin-creep torques. Wheel truing in combination with rail grinding is performed at Vancouver for this purpose.

Dry-Stick Friction Modifiers. Onboard lubrication of the tread with dry-stick friction modifiers to reduce or eliminate negative damping associated with stick-slip or roll-slip of the

wheel/rail contact has been claimed to reduce corrugation growth rates at the Vancouver Skytrain (2) and is very attractive from a theoretical standpoint. Further, there is some improvement of adhesion reported by the Sacramento RTD. However, long-term data on corrugation growth reduction are only now being developed by several light rail transit systems using the treatment, and observations at Sacramento RTD indicate that corrugation is not inhibited (3). The cost of onboard dry-stick lubrication is estimated to be about \$1,500 per vehicle per year, assuming that two axle sets of each vehicle are treated.

Comparing this cost with the cost of rail grinding and other treatments is difficult because train headways and consist lengths must be considered. Onboard lubrication is employed in conjunction with careful and aggressive rail grinding at the Vancouver Skytrain. Only anecdotal information has been obtained to indicate that dry-stick lubrication reduces the need for grinding. Further, at the Sacramento RTD, where dry-stick lubrication is used, rail corrugation was observed within 2 years after grinding, and corrugation has been observed at the Los Angeles Blue Line at an aerial structure with direct fixation track.

Damped Wheels. Damping of the wheel to reduce its response at corrugation frequencies is particularly attractive, though no data have been obtained indicating a reduction of corrugation rate with wheel damping. In any case, addition of damping to wheels should not increase the rail corrugation rate. A careful evaluation of damping should be conducted before employing damped wheels strictly for corrugation control. For instance, resilient wheels provide some additional damping, but has not prevented the occurrence of rail corrugation at the Portland, Sacramento, and Long Beach systems. The decision to use damped wheels, therefore, should be predicated on controlling squeal and other operational factors.

Conical Wheel Tapers. Crabbing of the truck induces lateral slip and possibly stick-slip oscillation at the wheel's fundamental lateral resonance frequency. Although this is most often associated with squeal at curves, such a mechanism may be responsible for rail corrugation at BART, which employs aluminum centered wheels with low damping ratios and cylindrical tread profiles. (BART is one of the few systems, perhaps the only system aside from the Chicago CTA, that employs a cylindrical tread profile.) The cylindrical wheel profile does not promote self-steering of the truck; therefore, the truck may not align itself along the center of the track. A conical wheel taper promotes centering of the truck and axles. Therefore, a possible approach for reducing rail corrugation at systems using cylindrical wheels is to change to a tapered wheel profile.

Infrequently trued wheels will lose their profile and, in extreme cases, develop conformal contact between the rail and wheel or develop a two-point contact with the rail. Therefore, adopting a conical tread profile to control lateral slip would be

useless unless truing is done frequently enough to prevent adverse contact conditions. Hunting of the truck is likely to increase with increasing conicity, and care must be taken in selecting rail and wheel profiles. Spin-creep is increased with increased wheel taper and thus may contribute to rail spin-creep corrugation, though the spin-creep torques would be maintained at minimal levels if the contact patch width is kept to $\frac{5}{8}$ in. or so. Further, there are many systems using conical wheels that experience rail corrugation; therefore, there is no guarantee that conical wheels will inhibit rail corrugation. The decision to employ a conical wheel, therefore, should be considered carefully, in relation to other factors such as ride quality. The cost of wheel profiling is negligible and, if successful, switching to a cylindrical profile may be one of the least costly corrugation control treatments available.

5.2.4.3 Wayside Treatments

The treatments identified for controlling normal rolling noise also are applicable to controlling noise from corrugated rail. However, corrugated rail produces higher levels of noise and a peaked frequency spectrum that is more detectible to the average receiver and thus may be more objectionable than normal rolling noise. Wayside treatments such as berms, barriers, receiver modifications, or tunnel wall sound absorption designed to control normal rolling noise would probably not be adequate to control noise from rail corrugation and, as a rule, trackwork or onboard treatments that reduce or eliminate corrugation are preferable to wayside treatments. If corrugation cannot be controlled, wayside treatments remain as an option.

5.3 CURVING NOISE CONTROL

As discussed previously, wheel/rail noise at curved track may differ considerably from such noise at tangent track and may include a combination of normal and excessive rolling noise, impact noise, noise resulting from corrugation, wheel squeal resulting from stick-slip oscillation, and wheel howl. Wheel squeal is the most common form of curving noise, caused by stick-slip oscillation during lateral slip of the tread over the rail head, and may be excruciating to patrons and pedestrians. Wheel howl at curves may be related to oscillation at the wheel's lateral resonance on the axle, caused by lateral slip during curving. At short radius curves where train speeds may be limited to 20 mph, rolling noise may be insignificant relative to wheel squeal. At curved track, normal rolling noise, excessive rolling noise resulting from roughness and corrugation, and impact noise resulting from rail defects and undulation are similar to those at tangent track. The user is referred to the section on tangent track for discussion of noise not directly related to curving. The discussion of curving noise control that follows focuses on wheel squeal and wheel/rail howl.

5.3.1 Wheel Squeal

Treatments for controlling wheel squeal are listed in Table 5-5 with respect to onboard, trackwork, and wayside application. Wayside treatments are primarily limited to sound barriers, receiver modifications, and subway structure sound absorption, which were discussed previously with respect to normal rolling noise. The spectra of squeal and howl, however, differ from those of normal rolling noise, and spectral characteristics should be considered in the design of wayside treatments.

The results of the survey of transit systems and inspection of track reveal a combination of factors which, taken together, appear to control or eliminate wheel squeal at embedded track. These are as follows:

- 1) Use of resilient wheels,
- 2) Resiliently supported track with 115 lb/rail,
- 3) 1/2-in. gauge widening at curves,
- 4) 1/4 in. wider wheel gauge than standard,
- 5) Minimum curve radius of 90 ft,
- 6) Rubberized grade crossing bearing against the rails at both sides,

TABLE 5-5 WHEEL SQUEAL NOISE CONTROL TREATMENTS

LOCATION	TYPE	NOISE RED. - dB	COST - \$	COMMENTS
Onboard	Resilient Wheels	10 to 20	\$2,000 to 2,300/wheel	Well demonstrated to be effective.
	Constrained Layer Damped Wheels	5 to 15	\$500 to \$1200/wheel	Effective
	Ring Damped wheels	5 to 10	30\$-50\$ per wheel	Used by Chicago CTA and MTA NYCT. May be most economical treatment.
	Wheel Vibration Absorbers	5 to 15	\$500 to 700/wheel	Demonstrated effectiveness in trials.
	Conical Wheel Taper	Elimination at large radius curves	\$0	Must be in combination with gauge widening or asymmetrical rail profile and flexible truck.
	Flexible Primary Suspension	Elimination at large radius curves	Unknown	Conical treads required to induce axle alignment with radius
	Steerable Trucks	Elimination at large radius curves	Unknown	Conical treads required to induce axle alignment with radius
	Onboard friction modifier	Possible elimination.	\$1,400 /vehicle/year	Limited effectiveness below 90 foot radii
Trackwork	Asymmetrical rail profile	Elimination at large radius curves	Nil	Must be in combination with conical wheels and flexible truck.
	Petroleum lubrication	Partially eliminates squeal	\$10,000 to \$40,000	Can lubricate flange only, so that effectiveness is limited.
	Water spray lubrication	Eliminates squeal	\$10,000 to \$40,000 per track curve	Not practical in freezing weather, though antifreeze can be used with water.
	Maintain constant gauge or gauge narrowing in curves	Reduces truck crabbing and potential for squeal	Nil	Gauge narrowing has been correlated with squeal elimination in conjunction with resilient wheels, HPF friction modifier, and elastomer rail embedments. (See Text)
	Restraining rails	Has inconsistent effectiveness	\$100 to \$200/tr-ft	Reduces truck crabbing and lateral slip, and, thus, squeal. Flange face must be lubricated.
	Rail vibration dampers	Unknown	\$20 to \$50/ft	Reported to be effective in Europe
	Rail Inlay - (anti-squeal)	Reduces squeal		Reduced or eliminated squeal at WMATA for several months
Wayside	Sound Barrier walls	7 to 10	\$20/sf	Does not eliminate squeal
	Absorptive Barriers	9 to 12	\$25/sf	Does not eliminate squeal
	Berms	10 to 13	NA	Does not eliminate squeal
	Subway wall treatment	5 to 7	\$7-\$10/ft ²	Does not eliminate squeal
	Receiver Treatments	NA	\$5,000 to \$10,000 per receiver	Does not eliminate squeal. Noise reduction dependent on construction

- 7) Onboard dry-stick low coefficient of friction flange lubrication,
- 9) Onboard dry-stick friction modifier applied to wheel tread,
- 10) Maintenance of conical wheel tread profile, and
- 11) Southern California climate.

There is no guarantee this combination of factors eliminates squeal, but this is the result observed at the Los Angeles Blue Line embedded curves in Long Beach, California. The researchers note that Long Beach is close to the ocean, and humidity is a factor in squeal generation. The observations at Long Beach were made during a very sunny day, and the tracks appeared to be very dry.

5.3.1.1 Onboard Treatments

Onboard treatments for controlling wheel squeal include resilient wheels, constrained layer damping, ring dampers, vibration absorbers, dry-stick lubrication, oil spray lubrication, conical wheel tapers, longitudinal primary suspension compliance, and steerable trucks. Of these, resilient wheels are the most popular and are almost universally used for light rail transit, though squeal is not eliminated at short radius curves under 100 ft. Conical wheel tapers and longitudinal truck compliance might reasonably be considered as standard in truck design, but they are also listed for systems with particularly stiff primary suspensions and cylindrical wheels. Some of the treatments, such as oil spray lubrication and steerable trucks, have received only limited application.

Resilient Wheels. Resilient wheels incorporate elastomer springs between the tire and wheel rim to provide compliance between these components. Examples of resilient wheels include the Bochum 54 and 84 wheels, the SAB wheel, and the older PCC wheel. Resilient wheels are fitted with most light rail transit vehicles and are enjoying widespread popularity. They are effective in reducing or eliminating wheel squeal at curves of radii greater than about 100 ft, though squeal may still occur. Examples of systems using resilient wheels include the Portland Tri-Met; Los Angeles Blue Line and Green Line; Pittsburgh; Bi-State Development Agency, St. Louis; San Jose; and Sacramento RTD. No heavy rail rapid transit systems appear to be using resilient wheels within the United States, though BART has a set of Bochum 54 wheels mounted on a single car, a set that has withstood roughly 10 years of service and one rebuild with no adverse consequences other than a problem with shunts, which was corrected.

Vibration dampers may be fitted to the tread of resilient wheels to further improve their squeal reducing characteristics. Regardless of the configuration, resilient wheels are expected to greatly reduce, if not eliminate, wheel squeal occurrence and energy. Electrical arcing may be a problem with internal electrical shunts, involving pitting of the interior surface of the tire tread, thus leading to a stress concen-

tration and possible fatigue failure. No direct evidence of this problem has been obtained, and external shunts with bolted connections would prevent arcing. A potential problem with external shunts may concern tread rotation relative to the rim, resulting in stretching or breakage of the shunts, though this has not been a problem with the single BART vehicle using resilient wheels.

Light rail transit systems have reported no difficulty in truing resilient wheels. The cost of a typical resilient wheel may range between \$2,400 and \$3,000, which can be compared with a cost of roughly \$700 for a standard solid steel wheel. However, after tread condemnation, the treads may be replaced with new treads and rubber springs, either at the factory or at the shop, thus saving the cost of the rim.

Constrained Layer Damped Wheels. Constrained layer damping consists of visco-elastic material constrained between the wheel web and a metal plate or ring. Constrained layer damped wheels have been shown to be at least partially effective in reducing squeal at SEPTA, MTA NYCT, and BART. Although damped wheels tend to be less effective than resilient wheels, they may have an advantage over resilient wheels in that monobloc or composite steel and aluminum wheels would not have any difficulty with dynamic alignment and can withstand high cyclic loading without heat buildup. A disadvantage of constrained layer dampers is that they add weight to the wheel, though this may be compensated partially by weight losses due to machining. Constrained layer damping treatments for wheels have not received much attention within the United States, perhaps because of cost, which could be as high as \$1,000 per wheel, depending on engineering requirements and quantity. Costs for constrained layer dampers tested at the MTA NYCT in 1984 were on this order, and applying a producer price index ratio of (1:2) would suggest a small quantity cost of about \$1,200 per wheel. Costs would be expected to be considerably less with quantity orders.

Wheel Vibration Absorbers. Wheel vibration absorbers are tuned and damped spring-mass mechanical systems that are attached to the tire to absorb vibration energy at wheel modal frequencies. The absorbers can be effective over a broad frequency range, though they are most effective if tuned to the modal resonance frequencies of the wheels. A disadvantage is that, similar to the constrained layer damper, they add weight to the wheel. Tuned vibration absorbers have not received widespread use within the United States, though they have been applied to European high speed rail systems. They have been recently tested, with varying degrees of success, most recently at the West Falls Church yard at WMATA. Additional testing is needed at short radius curves of light rail systems.

The cost for tuned vibration absorbers in large quantities may be between \$400 and \$700 per copy. Part of the cost includes engineering to tune the absorber to the resonance frequencies of the wheel, which may be unique to a given wheel design. Certain "broad band" absorbers would presumably avoid tuning problems, allowing "off-the-shelf" procurement,

though they might be less effective. Costs for materials and engineering should be discussed with the manufacturer carefully, and field testing of prototype units is very desirable before large scale procurement. A stress analysis may be advisable to evaluate the effect of the bolt holes on wheel stresses.

Ring Damped Wheels. Ring dampers typically consist of a $\frac{5}{8}$ -in.-diameter carbon steel rod bent into a circle and retained within a groove in the inside edge of the tire. Tests at SEPTA, CTA, and MTA NYCT indicate that ring dampers are effective in reducing wheel squeal. A major attractive feature of the ring damper is that its cost is the lowest of the damping technologies. At CTA, the ring damper is supplied with new wheels for an additional cost of about \$30 to \$50 per wheel, and little maintenance is required. Concerns have been expressed over the possibility of dirt or steel dust caking in the damping groove and inhibiting damper performance. CTA indicates that this has not been a problem, but such a problem has been observed at SEPTA during in-service tests with carbon steel rings. There is no known instance of the dampers falling from their grooves during service.

Dry-Stick Friction Modifier. Dry-stick friction modifiers are applied to the tread running surfaces of one or two axle sets of each vehicle to enhance adhesion and flatten the friction versus creep curve of the wheel and rail running surfaces, thus reducing negative damping and squeal. Dry-stick lubrication, which includes low coefficient of friction flange lubricant applied to the flange throat to reduce friction and flange wear, may help with curving of the truck and reduce lateral slip. Several light rail transit systems are now using onboard friction modifiers and flange lubricant on a regular basis, the most notable being the Sacramento RTD and the Los Angeles Blue Line.

No wheel squeal occurs at the embedded 90- and 100-ft radius curves of the Los Angeles Blue Line, which employs a combination of resilient Bochum 54 wheels and resilient embedded 115 lb/yd rail track with elastomer grade crossing bearing against both sides of the rails. Two axle sets of each vehicle are lubricated with HPF and LCF dry-stick lubricant. Further, the Los Angeles Blue Line vehicles have wheel gauge $\frac{1}{8}$ in. wider than standard, which reduces lateral slip in curves.

In contrast to the experience at the Los Angeles Blue Line, significant squeal was observed at the 82-ft radius embedded ballast-and-tie curves of the Sacramento RTD, which also employs resilient Bochum 54 wheels. The Sacramento system uses embedded ballast-and-tie track with a concrete road filler between the rails and asphalt at the field sides. These curves are restrained with lubricant applied to the restrainer, preventing flange contact at the high rail side. In spite of the lack of flange contact, squeal occurs. At the 100-ft radius curve, wheel squeal was much less than at the 82-ft radius curve, occurring at about 500 Hz. Only one axle set, on the idling truck, of the Sacramento RTD articulated vehicle is lubricated.

To be effective, the manufacturers indicate that onboard dry-stick lubricants must be applied at least to every vehicle,

and possibly every truck, to deposit sufficient lubricant to the running surface of the rail. The cost of friction modifier varies from system to system. Costs on the order of \$1,500 per vehicle per year are estimated for friction modifier applied to two axle sets of each vehicle. Maintenance and product loading costs are minimized with the use of rear loading lubricant holders, requiring only a few minutes per truck to change lubricant sticks.

Oil Drop. Portland Tri-Met has experimented with onboard oil dispensers on two vehicles out of a fleet of perhaps 50. This approach did not completely eliminate wheel squeal, and Portland Tri-Met is experimenting with dry-stick lubricants on every vehicle. The cost of oil drop or oil spray lubrication has not been determined, though a commercial lubrication system is available.

Conical Wheel Taper. A conical wheel profile reduces the longitudinal slip of the wheel over the rail by providing a rolling radius differential, provided that there is some lateral shifting of contact location brought about by gauge widening and/or asymmetrical rail profile grinding. However, lateral slip resulting from finite truck wheel base will still occur if there is no longitudinal compliance in the truck primary suspension to allow the axles to align themselves parallel with the curve radius. Providing primary suspension longitudinal compliance in combination with wheel taper and asymmetrical profile grinding is expected to reduce squeal. Relative longitudinal motion is not entirely compensated at curves of less than about 1,200- to 2,000-ft radius. Although wheels may be trued to a 1:40 or 1:20 taper, wear will eliminate taper with time, possibly leading to a concave tread. This has been observed at Sacramento RTD tangent track, where the wheel/rail contact was concentrated at the corners of the rail head on tangent track, rather than at the center, with a ball radius of about 7 to 12 in. Further, wheel squeal occurs at Sacramento. At systems with significant flange wear, truing occurs more frequently, so that taper may be preserved.

Flexible Primary Suspension. Trucks with compliant longitudinal stiffness in the primary suspension combined with conical wheel tapers promote steering and reduce axle crabbing angle, thus reducing lateral creep and squeal. Crabbing angles up to 5 deg may be expected for 90-ft radius curves; therefore, considerable flexibility must be incorporated into the primary suspension to reduce lateral creep at short radius curves, where lateral slip may never be fully prevented for practical tread profiles. At larger radius curves, the creep angle is lower, requiring less accommodation. At BART, for example, the shortest curve radius is about 360 ft, giving a creep angle of 1.2 deg, requiring on the order of plus or minus 0.05-in. longitudinal compliance at each bushing.

Conical wheels must be used with sufficient gauge widening to induce axle alignment with the curve radius and improve curving performance. Cylindrical wheels would not induce the necessary forces to cause the axles to shift later-

ally and produce a rolling radius differential and, thus, would not encourage the axles to align themselves parallel with the curve radius at the point of wheel contact. (These comments indicate that the control of wheel squeal requires cooperation between track and vehicle designers and departments responsible for maintenance of these components.)

Steerable Trucks. Steerable trucks have been developed for reducing wheel squeal by allowing the axles to align themselves parallel with the curve radius at the point of wheel contact. An example is the UTDC truck employed at the TTC Scarborough Line and the Vancouver Skytrain. Problems occurred with friction between the side bearing pads, which inhibited proper alignment of the axles on tangent track after coming out of curves. Although steerable trucks may eliminate axle crabbing, longitudinal slip must still occur unless compensated with rolling radius differential.

5.3.1.2 Trackwork Treatments

Trackwork treatments include restraining rails, flange lubrication, asymmetrical rail profile grinding, gauge widening, rail head inlays, hardfacing, rail vibration dampers, and frictionless rail. Of these, flange lubrication is the most common trackwork treatment for controlling wheel squeal. Rail inlays are effective in reducing squeal, but are limited in life. The remaining treatments have been tried at various systems with varying degrees of success, and care should be used in selecting these for incorporation in track as noise control provisions.

Flange Lubrication. Flange lubrication with automatic grease lubricators is employed by various systems to control wheel squeal, based on the theory that flange contact with the rail is the principal cause of squeal. Successful examples of this approach include those used by SEPTA. However, flange lubrication also may involve migration of lubricant to the rail running surface, and this limited and inadvertent lubrication may, in fact, be the principal cause of wheel squeal reduction. Excessive migration of lubricant to the rail running surfaces will result in loss of adhesion and braking performance and therefore is to be avoided. For this reason, flange lubrication may not be employed by many systems.

Water Spray Lubrication. Water sprays are used at some systems such as the MTA NYCT and TTC to control wheel squeal. The advantage of water spray over petroleum lubrication is that the water evaporates quickly and thus traction is reduced for only a short period of time and for a short distance. Also, water spray systems should pollute soils much less than petroleum systems. Water sprays cannot be used during subfreezing temperatures because of buildup of ice. The TTC incorporates water sprays during the nonfreezing periods of the year and grease lubrication during winter months. Water has a relatively low cost compared with petroleum products. No cost data have been obtained for water

spray systems, but these systems should be comparable to, if not less than, costs for grease lubricators.

Restraining Rail. A restraining rail can be employed at the low rail to guide the leading axle through the curve and reduce the axle crabbing angle. To the extent that flange contact may contribute to some forms of wheel squeal, preventing flange contact with the high rail would tend to reduce squeal, though the principal benefit would be a reduction of flange and gauge face wear. The trailing axle will tend to ride against the low rail; therefore, an additional restraining rail can be employed on the high rail side to further pull the low rail wheel away from the reduced crab angle.

The restraining rail should be lubricated with grease to prevent squeal from developing as a result of the wheel rubbing against the restraining rail. This should not result in migration of lubricant to the rail running surfaces, because only the back sides of the wheels would be lubricated. Wheel squeal will still occur if the curve radius is short enough, but the restraining rails should prevent unnecessarily large crab angles unless the flange way is too large. Restraining rails used simply to prevent wheel climb-out would also allow high rail wheel flange contact, not necessarily reduced crab angle. Careful adjustment of the restraining rail position is required to control crab angle, and subsequent wear of the restraining rail may require readjustment.

Asymmetrical Rail Profile Grinding. Asymmetrical profile grinding to offset the contact patch to the low rail side at both rails in combination with tapered wheel tread profiles reduces longitudinal slip of the wheel set. Further, a compliant primary suspension in the longitudinal direction (parallel with the track), in combination with tapered wheel treads to achieve a rolling radius differential, will allow the high rail wheel to translate along the rail faster than the low rail wheel and align the axle parallel with the curve radius, thus minimizing axle crab angle and lateral creep. Asymmetrical rail profile grinding would further this self-steering process and thus reduce wheel squeal.

Rail Head Inlay. Treating the rail running surface with a babbitt-like alloy inlay in the rail head can reduce wheel squeal caused by lateral stick-slip across the rail running surface by modifying the friction-creep curve. This treatment was successful at WMATA, though problems were experienced with retention of the material. After a period of several months, the inlay wore away, allowing direct contact between the wheel and carbon steel portions of the rail, and the effectiveness of the treatment at WMATA declined with wear. A variant of the rail head inlay is a resin or plastic that is deposited and bonded into a groove of similar dimensions to that used for hardfacing. No data have been obtained concerning noise reduction effectiveness, though the treatment appears to have been applied in Europe.

Hardfacing. Hardfacing with a very hard inlay has been used at SEPTA with mixed results, though the treatment

appears to be most desirable for controlling wear at curves. The use of hardfacing inlay at the flange contact face may not produce a reduction of squeal because, as theory suggests, the squeal is likely caused by lateral stick-slip of the wheel tread across the top of the rail. Still, the dissimilar metallurgical properties of the inlay and wheel tread material may modify the friction-creep behavior to have some benefit.

Rail Vibration Dampers. Rail vibration dampers have been advertised to reduce wheel squeal. If so, this would be contrary to expectations based on theoretical grounds, because of low participation of the rail in the squeal process relative to the wheel. However, reports provided by one manufacturer are encouraging. Rail vibration dampers consist of elastomer sheets or molded elastomer components that are held against the rail web with spring clips or clamps. They should be easily installed between the ties or fasteners, possibly without raising the rail. The lack of squeal at the Long Beach Blue Line 90- and 100-ft radius curves which have elastomer grade crossing embedded between and about the rails suggests that damping of the rail may be beneficial in reducing squeal, though other factors at Long Beach also may help to reduce squeal.

Gauge Widening. Gauge widening is reputed to reduce wheel squeal by increasing the rolling radius differential or by reducing flange rubbing. However, gauge widening promotes truck crabbing, increasing the angle of attack, or creep angle, of the wheel relative to the rail, thus increasing lateral creep and squeal. Thus, gauge widening should not be expected to reduce squeal unless a rolling radius differential can be effected. Further, high crab angle allows flange contact and wear at the high and low rail gauge faces, evidenced by a sharp edge between the gauge face and rail running surface, as has been observed at the MBTA. The Los Angeles Blue Line experiences no wheel squeal at short radius curves with $\frac{1}{4}$ in. wider wheel gauge and about $\frac{1}{2}$ in. of track gauge widening, resulting in about $\frac{1}{4}$ in. of gauge widening relative to standard clearance. This system also employs Bochum 54 wheels, onboard flange lubrication and tread friction modifier, resilient embedded track, and elastomer pavement at both sides of the rails, all of which may help to reduce or eliminate wheel squeal. Squeal is observed at the Sacramento RTD 82-ft-radius embedded ballast-and-tie curve with about $\frac{1}{4}$ -in. gauge widening. This curve also has a hand lubricated restraining rail which prevents flange contact at the high rail, though squeal appears to be generated primarily at the high rail, based on aural observation. Gauge widening does not prevent wheel squeal.

Frictionless Rail. The MBTA installed a modified 119 lb/yd rail with reduced rail head width to reduce the running surface at a 70-ft-radius single restrained curve on the Green Line. The Green Line vehicles use SAB resilient wheels which, by themselves, help to reduce squeal, and the restraining rail is well lubricated with automatic lubricators. Flange contact is popularly believed to produce squeal, con-

trary to the most likely theory of lateral slip as the cause of squeal, and the frictionless rail was intended to eliminate flange contact in conjunction with the restraining rail. In this sense, the frictionless rail represents another method of gauge widening.

The MBTA indicated that a noise reduction was obtained with the installation of the frictionless rail, but that wear evidently caused a recurrence of squeal, though the precise cause is uncertain. Visual observations conducted in July 1995 indicate that gauge face wear is occurring at the frictionless rail and, further, that there is substantial visual crabbing of the trucks in the curve. The substantial crabbing leads to high creep angle, or lateral creep, and thus promotes squeal, which appears to be produced by the high rail wheels. Also, the flange contact may be causing squeal, especially because of the large angle of attack, although frictionless rail with low rail head width may reduce or eliminate flange contact, such as what was not observed at the MBTA. Unless a restraining rail is adjusted to control crab angle, the use of frictionless rail will aggravate crabbing and thus squeal. In view of the above, simply using conventional rails with small ball radius and gauge widening would be equivalent to using frictionless rail.

Curvature Design. Limiting track radius of curvature to greater than 150 ft for vehicles with resilient wheels and 700 ft for vehicles with the solid wheels with conical treads is probably the most practical wheel squeal noise control provision for new track construction. These appear to be practical limits below which wheel squeal can be expected. In the case of light rail systems where tight curvature is required to negotiate intersections, 100 ft should be a limiting radius, though some limited squeal may be expected. Gauge widening should be avoided if possible. Although large radii are recommended for noise control, the benefits of reduced flange and rail wear should be obvious.

5.3.1.3 Wayside Treatments

As with other forms of wheel/rail noise, wayside treatments consisting of sound barriers, berms, and receiver treatments are applicable to wheel squeal. However, these treatments must be more effective than at tangent track, because of the pure tone character of wheel squeal. The average person is more sensitive to squeal than to broad-band passby noise, and reducing the noise with a barrier or receiver treatment may not be sufficient to prevent adverse community reaction. For this reason, treating the track or vehicle directly to eliminate wheel squeal is the most attractive approach.

Sound Barrier Design. Barriers are more effective at wheel squeal frequencies of about 1,400 to 4,000 Hz than they are for normal passby noise which may have a peak frequency in the range of 500 Hz on smooth ground rail. Usually, sound absorption applied to a barrier to control reflection will be more effective at squeal frequencies than at frequencies associated with rolling noise.

Receiver Treatments. Acoustically rated glazing must be selected to be effective in the range of 500 to 5,000 Hz. There may be significant dips in the sound transmission loss characteristics of window glazing which coincide with wheel squeal frequencies. For example, conventional thermally insulating glass exhibits a coincidence dip at 4,000 Hz which may coincide with the second mode of wheel tire squeal. Monolithic single-pane glazing exhibits a coincidence dip at 2,500 Hz which should be avoided if squeal frequencies are at that frequency. Single-pane glazing should be 1/4-in.-thick laminated glass, and thermally insulating glass should have at least one pane consisting of laminated glass, to avoid problems of this nature.

Station Treatment. Wheel squeal is not normally a problem in stations because tangent track is normally used adjacent to the platform. In this case, station treatment need only be applied to control rolling noise (as well as public address system performance and ancillary facility noise). An exception to this is the MBTA Green Line, where a station has a short radius curved section of ballast-and-tie track at patron level. Treatment of station walls and ceilings with sound absorption in such cases is desirable.

Subway Wall Sound Absorption. Curves beginning at the end of station platforms may cause considerable squeal which transmits to the station platform area and may be uncomfortable to patrons or interfere with conversation. In this case, sound absorption applied to the upper portion of subway walls and the ceiling in the curved track section may be effective in reducing squeal noise transmission to the station platform area. Car interior noise reductions would also be obtained with subway wall treatment. Car doors are often positioned near or over the trucks, and wheel squeal noise can be easily transmitted to the interior of the vehicle, where it may actually be painful to patrons. Sound absorption placed against the subway wall from floor to ceiling and extending throughout the curve would be particularly effective in controlling this transmission path, even with ballasted track where ballast normally provides some sound absorption. Cementitious spray-on sound absorbing materials are particularly attractive for this purpose, although the most effective treatment would be 2-in.-thick 3-pcf glass fiberboard encased in Tedlar plastic and protected with perforated powder coated metal.

5.3.2 Wheel/Rail Howl

Noise at moderate to large radius curves may be greater than at tangent track because of wheel lateral oscillation caused by uncompensated differential wheel velocities and lateral slip. The problem is exacerbated by cylindrical wheels with low damping ratios, such as the BART aluminum centered wheel. Wheel howl is closely related to wheel squeal, but differs in that it is believed by this author to not reach a saturated condi-

tion limited by nonlinearity of the wheel/rail interaction and friction-creep curve. Also, wheel howl differs from squeal in that it tends to increase in level with train speed, whereas wheel squeal may actually be inhibited by increasing train speed, and wheel howl is generally of lower level than wheel squeal. Wheel squeal may be viewed as a lightly damped harmonic oscillator excited by random forces produced by lateral slip. The oscillation involves rigid motion of the tire controlled by the bending stiffness of the web and axle. Wheel squeal, on the other hand, occurs at a higher frequency of about 1,400 Hz, related to the first distortional mode of the tire. Wheel howl might also be considered as poorly developed wheel squeal and might transform into saturated stick-slip oscillation at about 500 Hz. Wheel howl, in the absence of corrugation, is not necessarily a serious curving noise problem, though corrugation at curves may increase the howl to unacceptable levels. Finally, the opinion of this author is that wheel howl does not exist or is not sufficiently high in level to be identified at transit systems which use solid steel wheels with tapered wheel treads, by far the most common configuration. The problem appears to be limited to BART with aluminum centered wheels and cylindrical wheels.

Wheel/rail howl may be indistinguishable from corrugation noise, and wheel howl may ultimately be traced to corrugation, though it has been observed after rail grinding. Short pitch corrugation and howl at BART are most prevalent at curves, though they are not limited to curves. Lateral oscillation at about 500 Hz, driven by lateral slip, appears to contribute to corrugation at curves. The condition of the track should be checked prior to investigating possible treatments for wheel/rail howl. If the rails are found to have visible corrugation, not necessarily of high amplitude, the methods discussed for treating rolling noise caused by corrugation should be considered first. That is, the rail should be ground to remove corrugation and restore a smooth running surface. Profile grinding to provide a rolling radius differential is discussed below and should be considered in developing the grinding program. If, after rail grinding is completed, wheel/rail howl persists, the additional treatment approaches listed in Table 5-6 can be considered, many of which are the same as those for wheel squeal and/or rolling noise. The reduction of wheel/rail howl is expected to reduce rail corrugation to the extent that the corrugation is produced by the abrasive motion of lateral vibration of the wheel tread at the howl frequency.

5.3.2.1 Onboard Treatments

Many of the onboard treatments, such as skirts and undercar absorption, identified for controlling rolling noise may also reduce wheel howl slightly, and the user is referred to the discussion presented above with respect to these treatments. Wheel taper, rail profile, and primary suspension compliance need to be considered as a whole with respect to curving performance and reduction of lateral slip which is the principal cause of wheel howl.

TABLE 5-6 NOISE CONTROL TREATMENTS FOR WHEEL/RAIL HOWL

LOCATION	TYPE	NOISE REDUCTION - dBA -	COST	COMMENT
Onboard	Dry-stick friction modifier	Unknown	\$1,400 /vehicle/year	Theoretically attractive, but untested
	Resilient wheels	5 to 15	\$2,400 - \$3,000 /wheel	Most effective proven technology
	Constrained layer damped wheels	5 to 10	\$1,000 /wheel	Proven technology
	Wheel vibration absorbers	Unknown	\$500 to \$700/wheel	Not proven, but expected to be effective
	Ring dampers	Unknown	\$75/wheel	Untested for howl
	Conical wheel taper	Unknown	\$0	Reduces lateral and longitudinal slip
	Longitudinally compliant primary suspension & steerable truck	Unknown	Unknown	Reduces lateral and longitudinal slip. May have problem with ride quality and truck dynamics
	Improved car body sound insulation	Depends on car body design	Unknown	For car interior noise
Trackwork treatments	Profile rail grinding	5 to 7		Must be in conjunction with conical tread tapers
	Superelevation	Unknown, but expected to be minor	0	Theoretically attractive
Wayside	Treatments associated with rolling noise control			Does not eliminate howl

Speed Reduction. Wheel/rail howl tends to decline or disappear with speed reduction. Therefore, if howl is excessive, speed reduction can be considered as a noise mitigation measure. This is likely to be incompatible with operational objectives for the transit system, but may represent a short-term solution.

Resilient Wheels. Resilient wheels have been shown to inhibit wheel howl at curves of 340- and 470-ft radius with smooth ground rail at BART. To the extent that the wheel/rail howl involves lateral vibration of the tire as it undergoes lateral creep or slip across the rail head, a reduction of wear and thus corrugation due to wear might be expected with the use of resilient wheels. However, light rail systems using resilient wheels experience corrugation at both tangent and curved track, indicating that resilient wheels do not prevent corrugation. The noise reduction achieved with resilient wheels is likely to result from its higher lateral compliance relative to solid wheels. The performance is similar to that obtained for wheel squeal and, indeed, the squeal reduction data reported for resilient wheels are based, in part, on wheel howl reduction data for BART. The comments provided in connection with wheel squeal control with respect to cost and limitations of resilient wheels for controlling wheel squeal are relevant here as well.

Constrained Layer Damped Wheels. Constrained layer damped wheels have been shown to reduce wheel/rail howl at 500 Hz at curves at BART. The treatment involved a con-

strained damping treatment adhered to the wheel web. However, most wheel damping systems are optimized for wheel squeal in the higher frequency range of 1,000 to 5,000 Hz; therefore, their vibration reduction effectiveness at the typical howling frequency range of 250 to 1,000 Hz may be marginal. In addition, a constrained layer treatment applied only to the wheel tire would not absorb energy at the web and therefore would be ineffective in controlling wheel howl. The damping treatment must be applied at the location of greatest bending strain, which occurs at the wheel web for howl frequencies. An advantage of damped wheels over resilient wheels is that they have the same rigidity as undamped solid wheels and damped wheels and have no elastomer springs which may generate heat due to hysteresis.

Wheel Vibration Absorbers. Wheel vibration absorbers may be more effective than constrained layer damped wheels for reducing wheel howl if the vibration absorber frequency can be tuned to about 500 Hz. This may require absorbers with considerably greater mass than those intended for conventional squeal control. Other than this, the same comments as given above for damped wheels apply. The cost of tuned wheel vibration absorbers is expected to be on the order of \$400 to \$700 per wheel. Costs might be lessened if ordered in sufficient quantities.

Dry-Stick Friction Modifier. Dry-stick lubrication with a friction modifier has been proposed to reduce the tendency

for stick-slip and squeal at curves. No data have been obtained identifying the friction modifier as being effective at controlling howl at curves, but the theory of lateral stick-slip would suggest that unsaturated lateral oscillation of the wheel set might be reduced simply by reducing the negative damping associated with the negative slope of the friction-creep curve. Experiments are necessary to quantify any noise reduction that might be obtained prior to selection.

Wheel Truing Profile. Providing and maintaining a conical tread profile will encourage the high rail wheel to ride higher, close to the flange, thus allowing it to travel faster around the curve than the low rail wheel without slip. The effect is improved if the rail also is asymmetrically ground to move the contact patch of the high rail close to the gauge side and the contact patch of the low rail close to the field side. These provisions alone are not enough to prevent lateral creep because of the finite wheelbase of the truck, unless there is sufficient longitudinal compliance in the primary suspension to allow the axles to align themselves perpendicular to the tangent to the rail at the point of contact. (This is the motivation for the steerable truck.) Conversely, without a conical tread taper, there would be no force generated to cause the axles to align themselves perpendicularly to the rail, even with a longitudinally compliant truck. (See the discussion in Chapter 4 on wheel/rail noise generation concerning wheel squeal due to lateral stick-slip.)

Primary Suspension Longitudinal Compliance. As discussed above, reducing the primary suspension compliance in the longitudinal direction may allow the axles to better align themselves with curve radii and reduce or eliminate lateral slip due to finite truck wheel bases. However, reducing primary stiffness may not be effective with cylindrically tapered wheels. Further, ride quality and truck dynamics could be adversely affected by reducing the longitudinal stiffness. Testing and analysis should be conducted to ensure proper performance of the vehicle with reduced longitudinal stiffness.

5.3.2.2 Trackwork Treatments

There are few other trackwork treatments that might be applied to control wheel howl without corrugation. Trackwork treatments might include asymmetrical profile grinding and possibly correction of superelevation imbalance. To the extent that pinned-pinned vibration of the rail at about 500 Hz may be modulating lateral wheel/rail forces, reducing the fastener pitch to 24 in. may help to reduce howl, though this is strictly conjecture on the part of this author. Lubrication is definitely not an option.

Profile Rail Grinding. Asymmetrical profile grinding on an optimized grinding interval in conjunction with conical wheel tread profiles will provide a rolling radius differential and may promote self-steering of the axle to minimize or eliminate howl in the absence of corrugation at large radius curves. Further, there may be a reduction of any

related rail corrugation rates. A programmable profile rail grinder is desirable to simplify set up and speed grinding operations at curves.

Superelevation. Superelevation tends to relieve the static load on either the high or low rail, depending on speed and degree of superelevation. Under light wheel load, the wheel tread may more easily slip over the rail when negotiating a curve, with attendant oscillation, than with a heavier wheel load. BART has reported just such an effect with respect to rail corrugation generation. Thus, matching the superelevation to train normal operating train speed would appear to be beneficial. Costs associated with maintaining superelevation balance are not known, but are expected to be part of normal track maintenance.

5.3.2.3 Wayside Treatments

Wayside noise control treatments such as sound barriers and receiver treatment are all effective in reducing howl noise at curves, just as they are in reducing rolling noise. However, barriers, berms, and receiver treatments would not eliminate the tonal character associated with howl and short-pitch corrugation and, because of the higher amplitude and detectability of howl at curves, may not be sufficient without a substantial increase in height, transmission loss, and so on. Further, wheel/rail howl, especially when associated with rail corrugation, can generate adverse community reaction at relatively large distances from the track and, because of adverse propagation conditions, barriers may not provide the necessary noise reduction to satisfy the community. Treating individual receivers over large distances from the track is uneconomical unless only a few receivers are involved. Thus, wayside treatments should not be the first line of defense in controlling howl due to stick-slip oscillation and/or corrugation. Subway wall treatment will be effective in reducing wheel/rail howl, just as it is in reducing squeal and rolling noise.

5.4 SPECIAL TRACKWORK

Special trackwork includes turnouts, crossovers, and switches, which may cause particularly intrusive impact noise. The theory of impact noise is discussed in the preceding chapter on wheel/rail noise generation. Impact noise from special trackwork is usually associated with switch frogs and crossover diamonds. In particular, impact noise is generated as the tire traverses the gap in the frog or diamond and is described by the theory of impact noise for a wheel traversing a gap. Noise control measures are thus directed at reducing or eliminating the frog gap.

5.4.1 Special Trackwork Designs for Noise Control

Noise control methods which may be applied to special trackwork are listed in Table 5–7 and include moveable point

TABLE 5-7 SPECIAL TRACKWORK NOISE CONTROL TREATMENT SELECTION

Location	Treatment Type	Noise Reduction - dBA -	Cost	Notes
Trackwork	Moveable Point Frogs	7	\$120,000/turnout	Requires additional signalling
	Spring frogs	5	\$6,000/frog	May produce noise for trains turning out
	Flange Bearing	3	Nil	Standard Design for embedded girder rail track
	Welded "Vee"	5	Nil	No significant cost difference relative to standard frog
	Floating slab cut	5	Unknown	Reduces floating slab rumble in tunnels
Onboard	Undercar absorption	0 to 2	\$3,500 per vehicle	
	Soft primary suspension	0 to 6	Nil	Any noise reduction depends on design. Noise reduction applies to vehicle interior noise
	Resilient wheels	3	\$2400 to \$3,000 / wheel	
Wayside	Sound barriers	5 to 10	\$20/sf	Must account for low frequency impact noise
	Receiver sound insulation	0 to 10	\$5,000 to 10,000 per residence	
	Subway wall and ceiling sound absorption	5 to 7	\$10/sf	

frogs, spring frogs, and embedded-track flange-bearing frogs. Reduction of impact noise is the result of reduction of impact forces; therefore, a reduction of truck shock and vibration may be expected, which may lead to reduced truck maintenance.

5.4.1.1 Moveable Point Frogs

Moveable point frogs are most suited to high-speed turnouts. They are used in the railroad industry primarily as a means of reducing frog and wheel wear under high load environments. They are particularly effective for noise control because they virtually eliminate the gap associated with normal rail bound manganese frogs. Switches with moveable point frogs require additional signal and control circuitry compared with those with standard frogs; as a result, the total cost of a turnout with moveable point frogs is about \$200,000, roughly twice that of turnouts with standard frogs.

5.4.1.2 Spring Frogs

Spring frogs are suitable for low-speed turnouts and crossovers where use is occasional or emergency in nature, because ancillary noise may be produced by the spring frog for other than tangent running trains. Where frequent use of the turnout is expected, the spring frog may not be appropriate because of secondary noise related to spring frog actua-

tion. The cost of a spring frog is roughly \$12,000, twice the cost of a standard frog. The incremental cost of a turnout with spring frogs relative to the cost of a turnout with standard frogs is thus relatively small. Spring frogs are not appropriate for speeds greater than about 20 mph.

5.4.1.3 Flange-Bearing Frogs

Flange-bearing frogs are used in embedded track and support the wheel flange as the tread traverses the frog gap. Flange-bearing frogs do not necessarily eliminate impact noise and vibration, and their effectiveness depends on the degree of frog and flange wear. Flange-bearing frogs are not used in high-speed sections of nonembedded track and therefore are not normally considered as a noise control treatment.

5.4.1.4 Welded V-Frogs

Welded V-frogs have been tested at BART with high-speed heavy rail transit vehicles and have been found to be effective in controlling impact noise and vibration for trains operating at 50 to 70 mph.

5.4.1.5 Welding and Grinding

Maintenance of frogs by welding and grinding the frog point results in lower impact forces and thus lower impact noise levels and wheel and frog wear.

5.4.1.6 Floating Slab Cuts

Substantial rumble noise is generated by special trackwork located on large continuous floating slabs. The floating slab acts as a sounding board and is particularly efficient in radiating noise. An effective method to control this type of noise is to cut the slab between the tracks. The cut should be 1 in. wide and should be filled with a closed cell foam neoprene or other suitable filler. The practicality of this may be limited by design details, slab reinforcement, trackwork geometry, and so on.

5.4.2 Onboard Treatments

There are few onboard treatments available for reducing special trackwork noise. However, some of the treatments identified for controlling rolling noise may be beneficial in reducing impact noise. These are undercar absorption and suspension design, both of which are applicable primarily to car interior noise control.

5.4.2.1 Undercar Absorption

Undercar absorption over the truck area should be effective in reducing special trackwork noise in subways with direct fixation fasteners by a few decibels in a manner similar to that expected for normal rolling noise. Sound absorption by ballasted track would obviate the usefulness of undercar absorption.

5.4.2.2 Suspension Design

Resilient bushings and springs must be included in the truck design to reduce impact noise transmission into the car body, and soft Chevron suspensions are expected to transmit less impact vibration and noise into the truck and car body than rubber journal bushing suspensions. Primary suspension modifications to existing vehicles are not normally considered for noise control, though experiments have been conducted with the prototype BART vehicle and the MARTA C-Car, the latter with respect to ground vibration reduction. Primary suspension design is a factor in new vehicle procurements, and specifications may be written to achieve desirable limits on car interior noise. Of particular concern are any drag links and traction linkages which may transmit impact vibration into the car body. These must be isolated with elastomer bushings.

5.4.2.3 Resilient Wheels

Resilient wheels reduce shock and vibration transmission into the truck and car body and thus may be expected to reduce vehicle interior impact noise at certain frequencies,

though the A-weighted noise reduction may be slight. No data have been collected indicating the possible car interior noise reduction obtained with resilient wheels at special trackwork.

5.4.3 Wayside Treatments

Wayside treatments for impact noise from special trackwork include provision of sound barriers, receiver treatments, and subway wall sound absorption. These are discussed briefly below, and more detailed discussion may be found with respect to rolling noise control.

5.4.3.1 Sound Barriers

Because of the intrusive nature of impact noise at special trackwork, sound barriers may be desirable in residential areas near special trackwork installations not involving moveable point or spring frogs. Barriers would be impractical in street settings. Even with barriers, impact noise from special trackwork is easily detected in the presence of normal background noise, and low-frequency impact noise may penetrate building interiors more readily than the higher frequency components of normal rolling noise. Thus, barriers should be higher than normally required for controlling normal running noise.

5.4.3.2 Location

For new systems, every effort should be expended to locate special trackwork away from residential receivers or other sensitive receivers such as parks, schools, libraries, hospitals, theaters, auditoriums, and any other receivers where low ambient sound levels are a prerequisite for use. Relocation of existing special trackwork may not be practical, but should be considered as an option.

5.4.3.3 Receiver Treatments

Receiver treatments can be considered in reducing noise from special trackwork. However, the low-frequency energy and impulsive character of special trackwork noise requires that window glazing be more effective than would be considered for normal rolling noise. Laminated glass should be employed in most cases to provide additional noise reduction over that obtained with standard monolithic glass.

5.4.3.4 Subway Wall Treatment

Special trackwork noise in tunnels may be reduced by application of sound absorption to subway walls in the vicinity of special trackwork. Sound absorption reduces not

only vehicle interior noise, but also station platform noise. Special trackwork is often located at the end of a station platform, and special trackwork noise reduction can improve the overall station noise environment. Costs for subway wall treatment are expected to be on the order of \$10 per square foot.

5.5 REFERENCES

1. BC Transit, private communication. (1994).
 2. BC Transit, private communication. (1994).
 3. Nelson, J.T., Wayside Noise Measurements at the Sacramento RTD, Wilson, Ihrig & Associates, Inc., Technical Memorandum, TCRP Project C-3, Unpublished Final Report (June 1995).
-

CHAPTER 6: COST ANALYSIS

- 6.1 Introduction, 93
- 6.2 Equivalent Uniform Annual Cost Model, 93
 - 6.2.1 Description of Model, 93
 - 6.2.2 Fundamental Assumptions, 93
 - 6.2.2.1 Disregard Inflation, 93
 - 6.2.2.2 Constant Interest Rate, 94
 - 6.2.2.3 Disregard Nonquantified Factors, 94
 - 6.2.2.4 Availability of Funds, 94
 - 6.2.2.5 Funds Earn Interest Until Used, 94
 - 6.2.3 The Method, 94
 - 6.2.3.1 Future Single-Payment Present Worth, 94
 - 6.2.3.2 Uniform Series Present Worth, 94
 - 6.2.3.3 Capital Recovery, 95
 - 6.2.4 A Simple Example, 95
 - 6.2.5 Another Example—Rail Grinding Machine, 95
- 6.3 Representative Costs, 96
 - 6.3.1 Onboard Treatments, 96
 - 6.3.1.1 Wheel Truing Machines, 96
 - 6.3.1.2 Dry-Stick Lubrication, 97
 - 6.3.1.3 Resilient Wheels, 97
 - 6.3.1.4 Wheel Vibration Absorbers, 98
 - 6.3.1.5 Visco-Elastic Dampers, 98
 - 6.3.1.6 Ring Damped Wheels, 98
 - 6.3.1.7 Undercar Absorption, 98
 - 6.3.1.8 Skirts, 98
 - 6.3.1.9 Slip-Slide Control, 98
 - 6.3.2 Trackwork Treatments, 99
 - 6.3.2.1 Rail Grinding (In-House), 99
 - 6.3.2.2 Rail Grinding (Contracted), 99
 - 6.3.2.3 Joint Tightening and Maintenance, 100
 - 6.3.2.4 Joint Welding, 100
 - 6.3.2.5 Hardfacing, 100
 - 6.3.2.6 Trackbed Sound Absorption, 100
 - 6.3.2.7 Defect Welding and Grinding, 100
 - 6.3.2.8 Rail Vibration Absorbers, 100
 - 6.3.2.9 Rail Vibration Dampers, 100
 - 6.3.3 Wayside Treatments, 100
 - 6.3.3.1 Station Sound Absorption Treatment, 100
 - 6.3.3.2 Subway Wall and Ventilation Shaft Treatments, 101
 - 6.3.3.3 Sound Barriers, 101
 - 6.3.3.4 Receiver Treatments, 101
- 6.4 References, 101

CHAPTER 6

COST ANALYSIS

6.1 INTRODUCTION

The purpose of this chapter is twofold. First, a basic engineering economic cost calculation method to compare various noise mitigation options is described. Although simple, the basic method should cover most of the scenarios faced by the transit engineer. The cost model may be familiar to engineers and controllers normally faced with the problem of procuring equipment or developing certain programs. The approach here is to motivate transit system planners, controllers, and operators to take the “long view” with respect to noise control treatment selection. The second purpose of the chapter is to present representative cost data (1995 dollars) for various system components used to control noise. Manufacturers and contractors should be consulted for more precise figures when considering treatment alternatives, because prices for materials and labor can vary widely depending on volume, locality, and labor rates.

6.2 EQUIVALENT UNIFORM ANNUAL COST MODEL

An economic model is developed to provide a means for comparing the cost of noise control treatments on a uniform basis. The model incorporates initial expenditures for equipment and products, annual maintenance, operational costs, and salvage values. The methodology is implemented in the computer software package to facilitate cost comparisons. A feature of the software package is a graphic representation of the cash cost per year needed for a specific treatment.

6.2.1 Description of Model

The primary goal of *engineering economic analysis* is to compare the costs of various technical options, which often have widely disparate expenditure schedules and life cycles, on an “apples-to-apples” basis. To do this, the *annual cost method* (also known as the *capital recovery method*) is used to estimate the amount of money one would have to pay annually during the life of the treatment alternative if all of the necessary funds were borrowed at the beginning of the treatment program. This amount is termed the *equivalent uniform annual cost* (EUAC). The annual cost method implicitly assumes that whichever treatment alternative is

chosen, it will continually be renewed up to the life of the longest option considered.

The method does not include a monetary value for the benefit realized by the reduction of noise provided by the various components under consideration, but gives the transit engineer some indication of the costs associated with various alternatives which can then be used in conjunction with other relevant factors to arrive at an informed decision.

The basic method allows for one initial expenditure, a constant yearly expenditure, three periodic expenditure schedules, three singular expenditures, and a final scrap value. The life span of the alternative must be specified, as well as information about the periodic and singular expenses. Finally, an interest rate must be estimated to account for the time value of money.

6.2.2 Fundamental Assumptions

The annual cost method makes many assumptions, some of which may be poor approximations of reality. Nevertheless, they are made to obtain a solution. The assumptions should be kept in mind, and their implications for the results of the analysis should be understood.

Key assumptions used in this economic cost model are as follows:

- Disregard inflation,
- Assume a constant (fixed) interest rate,
- Disregard nonquantified factors,
- Assume that funds are available, and
- Assume all funds earn interest at the effective rate until used.

Following is a brief discussion of each assumption.

6.2.2.1 Disregard Inflation

Accounting for a constant inflation factor in an economic model is undesirable because it adds complexity to the calculations *without affecting the relative results*. If constant inflation were accounted for, the monetary values at the end of the analysis would be closer to those actually realized (within the limits of the gross assumption of constant infla-

tion), but the ranking of the various alternatives on a cost basis would be the same. As was stated previously, the goal of engineering economic analysis is to obtain such a ranking, and the monetary values obtained are only indicative of the actual costs that would be incurred.

6.2.2.2 Constant Interest Rate

Although interest rates fluctuate regularly, a constant effective rate can be reasonably well estimated over any given number of years. Therefore, this assumption, which greatly simplifies the mathematics, is reasonable as long as a good estimate is made.

IMPORTANT NOTE REGARDING INTEREST RATE:
The interest rate a bank offers comprises two components: one component accounts for the “price” paid for the convenience of borrowing the money and the other accounts for inflation. The price component is sometimes referred to as the *real* interest rate. Thus,

$$\text{Bank Rate} = \text{Real Rate} + \text{Inflation Rate}$$

Because this analysis disregards inflation in cost calculations, only the real interest rate should be used. For most economic conditions, the real interest rate is about 3 to 4%.

6.2.2.3 Disregard Nonquantified Factors

The economic model being developed here is a cost model, which is meant to reflect the expenditures one could expect by pursuing any of the various options analyzed. If some element or ramification of a system under consideration does not have a quantified cost associated with it, it cannot be included in the calculation. For example, even if the alternative with the longest life has the lowest EUAC, it may not be the best choice if technological innovations are expected to eclipse the usefulness of the component long before its expected life has been reached. This potentially decisive factor should be considered by the transit engineer, but there is simply no way to include it in the cost analysis being described here, unless the cost can be estimated quantitatively.

6.2.2.4 Availability of Funds

This analysis is used to determine the equivalent uniform annual cost over the life of the project. The component with the highest up-front cost might actually be the least expensive in the long run. For this reason, no technically viable solutions should be excluded from the analysis, and one should assume that sufficient funds will be available for any technically satisfactory option. If this assumption does not turn out to be correct, and alternatives with large initial expenditures are ruled out, the analysis will at least serve to gauge how economically efficient the remaining options are.

6.2.2.5 Funds Earn Interest Until Used

This assumption accounts for the fact that money which is not spent can be “put to work” earning interest payments for future cost obligations. Alternatively, interest does not have to be paid on money which is not borrowed right away. Either way, postponing expenditures will be beneficial if the amount paid down the road is less than the money saved by postponing the expense plus the interest accrued on that amount.

6.2.3 The Method

The EUAC model accounts for the following cash flows:

- Initial expenditure,
- Yearly expenditures (inspection, maintenance, etc.),
- Periodic expenditures (e.g., an operation which occurs biannually),
- Singular expenditures (e.g., a one-time machine rebuild), and
- Final salvage value recovery.

To calculate the EUAC of a system or component, the present value (or present worth) of each of these expenditures is calculated, the present values are summed, and the sum is amortized over the life of the item being considered. These calculations are facilitated by the use of three elementary accounting discount factors to account for the time value of money: the *future single-payment present worth*, the *uniform series present worth*, and the *capital recovery* factors. Each discount factor is described below.

6.2.3.1 Future Single-Payment Present Worth

This factor converts a future single-payment amount to its present value. The factor, designated by P/F, is calculated as

$$P/F = (1+I)^{-n}$$

where I is the annual interest rate and n is the number of years in the future in which the payment will be made. For example, at 5% interest the present value of a \$100 payment to be made in three years is $\$100 \cdot (1.05)^{-3} = \86.38 .

6.2.3.2 Uniform Series Present Worth

This factor converts an annuity payment for n years to the present value of those payments. The factor, designated by P/A, is calculated as

$$P/A = [(1 + I)^n - 1] / [I \cdot (1 + I)^n]$$

where I is the annual interest rate and n is the number of years for which the annuity is paid. For example, at 3% interest the present value of a \$25 annuity for 5 years is $\$25 * [(1.03)^5 - 1] / [0.03 * (1.03)^5] = \114.49 .

6.2.3.3 Capital Recovery

This factor converts a present value to an annuity payment over n years. The factor, designated by A/P, is calculated as

$$A/P = [I * (1 + I)^n] / [(1 + I)^n - 1]$$

where I is the annual interest rate and n is the number of years for which the annuity is paid. For example, at 8% interest the annuity payment over 30 years for a present value of \$250,000 is $\$250,000 * [0.08 * (1.08)^{30}] / [(1.08)^{30} - 1] = \$22,206.86$.

6.2.4 A Simple Example

Consider the EUAC for two components, each of which lasts 3 years. Component A costs \$100 and requires no other expenditures, and Component B costs \$50 and requires \$19 worth of maintenance per year. Both components are worthless at the end of the 3 years, and the real interest rate is 10%

For Component A, the EUAC is simply the \$100 purchase price (already at present value) amortized over the 3 years by the capital recovery discount factor:

$$EUAC(A) = \$100 * [0.10 * (1.10)^3] / [(1.10)^3 - 1] = \$40.21$$

For Component B, the EUAC is the \$50 purchase price plus the present value of the three \$19 yearly expenses all amortized over the 3 years. First, calculate the present value of all the expenses:

		<u>Present Value</u>
Purchase Price	\$50	= \$50.00
First Year Expenses	$\$19 * (1.10)^{-1}$	= \$17.27
Second Year Expenses	$\$19 * (1.10)^{-2}$	= \$15.70
Third Year Expenses	$\$19 * (1.10)^{-3}$	= <u>\$14.27</u>
		\$97.24

(NOTE: The present value of the three yearly expenses, \$47.24, could also be calculated using the P/A discount factor.)

Then amortize the present value over the 3 years:

$$EUAC(B) = \$97.24 * [0.10 * (1.10)^3] / [(1.10)^3 - 1] = \$39.10$$

Thus, Component B, despite having a higher nominal cost ($\$50 + 3 * \$19 = \$107$), is the less expensive alternative over the 3-year period because the \$50 saved in the beginning

accrues enough interest to cover the three \$19 annual expenses and leave a little excess.

If this example is repeated with an interest rate of 5%, $EUAC(A) = \$36.70$ and $EUAC(B) = \$37.40$. At the lower interest rate, the \$50 saved does not earn enough interest to cover the maintenance payments; therefore, Component A, despite its higher initial cost, is the better value, illustrating the importance of estimating an accurate figure for the real interest rate. Again, the real interest rate is the difference between the total “bank” interest rate and the inflation rate.

6.2.5 Another Example—Rail Grinding Machine

The data for two machines (perhaps rail grinding machines) being considered for purchase are as follows:

	<u>Machine A</u>	<u>Machine B</u>
Expected Life (years)	5	10
Initial Cost (\$)	700,000	1,500,000
Final Salvage Value (\$)	50,000	50,000
Yearly Expenses (\$)	100,000	50,000
Overhaul Expenses		
Year	N/A	6
Parts and Labor Less Core (\$)	N/A	180,000

Assume an effective annual real interest rate of 3%.

The present value of the various expenditures for Machine A is

		<u>Present Value</u>
Purchase Price	\$700,000	= \$700,000
Salvage Value	$\$50,000 * (1.03)^{-5}$	= -\$43,100
Yearly Expenses	$\$100,000 * [(1.03)^5 - 1] / [0.03 * (1.03)^5]$	= \$458,000
		<u>\$1,114,900</u>

This figure, amortized over the 5-year life of the machine, is the EUAC:

$$EUAC(A) = \$1,114,900 * [0.03 * (1.03)^5] / [(1.03)^5 - 1] = \$243,400$$

The present value of the various expenditures for Machine B is

		<u>Present Value</u>
Purchase Price	\$1,500,000	= \$1,500,000
Salvage Value	$\$50,000 * (1.03)^{-10}$	= -\$37,200
Yearly Expenses	$\$100,000 * [(1.03)^{10} - 1] / [0.03 * (1.03)^{10}]$	= \$426,500
Overhaul Expenses	$\$180,000 * (1.03)^{-6}$	= <u>\$150,700</u>
		<u>\$2,040,000</u>

Amortizing over the 10-year life of the machine, the EUAC is

$$\begin{aligned} \text{EUAC(B)} &= \$2,040,000 * [0.03 * (1.03)^{10} - 1] / [(1.03)^{10} - 1] \\ &= \$239,200 \end{aligned}$$

At 3% interest rate, Machine B is the more economically efficient option because the lower yearly costs over the life of the machine more than compensate for the higher initial expenditure and the overhaul expenses. At a higher interest rate, say 5%, this would not be true because the savings that come with purchasing the initially less expensive Machine A would accrue enough interest over time to make the higher yearly expenses worthwhile.

Note that although the life of Machine A is only half that of Machine B, a second machine is required at year 6 to continue grinding to year 10. Even with the need to purchase a new machine, the EUAC provides a direct comparison of annual costs for the machines, because the future costs for the second machine would produce the same current EUAC, assuming that all costs change according to the real interest rate. Note that including inflation may change this conclusion.

The selection of the machine may be influenced by non-quantified factors: the more expensive machine may be able grind rail to closer tolerances and provide certain computer-controlled grinding features that the less expensive machine may not. At the lower interest rate, the decision to select the more expensive machine is further motivated by the non-quantified features. At the higher interest rate, the higher EUAC for the more sophisticated machine is balanced to some extent by the nonquantified features, which must be factored into the overall decision-making process. Again, cost should not be the only criterion for selection.

6.3 REPRESENTATIVE COSTS

This section provides representative cost data for the noise control measures being discussed in this manual. As was discussed previously, projected cost calculations require the use of a constant real interest rate. Five percent is assumed for all of the calculations in the estimates that follow, unless otherwise noted.

As indicated, the costs are only representative. Noise control treatments and equipment are rarely off-the-shelf items, and there is some flexibility in costs depending on availability, quantities ordered, level of technological innovation, and patents. The user should therefore contact manufacturers directly to obtain up-to-date costs for initial procurement, installation, maintenance, materials, and salvage. Further, arriving at direct cost comparisons requires knowledge of the number of vehicles using a particular line and the length of the line, two factors which may vary substantially from property to property. For example, BART has approximately 140 mi of track and on the order of 500 vehicles operating in 10-

car consists. A light rail system may have as little as 20 mi of track and 20 or 30 vehicles operating in 1- to 3-car consists. Thus, there are large differences in scale which must be considered. The tables provided here attempt to provide some uniformity in presentation, but direct comparison between onboard and trackwork treatments is very system-specific.

Ancillary cost savings resulting from application of noise control treatments are not directly considered. For example, re-tiring of resilient wheels need not require replacement of the aluminum center, thus providing a cost savings at tread renewal time. There may be reductions in truck vibration and shock loading resulting from use of resilient wheels, which may lead to savings in traction equipment maintenance and reduction of failure rates, but these cost savings are non-quantifiable at present. Rail grinding may actually extend rail life by reducing shock and vibration and by optimizing metal removal rates. These cost savings, if quantifiable, can be worked into the model by simple subtraction from the EUAC or present values.

The costs are obtained in part from the literature, with an adjustment for producer price index changes; from the survey; and from discussion with transit engineers. Costs were considered in 1974 with respect to the MBTA Pilot Study (1); again by Kurzweil et al. in 1981 (2); by Saurenman et al. in a study involving the SEPTA system (3, 4); and in a study of damped wheels at MTA NYCT (5).

6.3.1 Onboard Treatments

Onboard treatments include special wheels, undercar absorption, and other systems and components attached to the transit vehicle. Onboard treatments also include the tuning and maintenance of these components, such as by wheel truing.

6.3.1.1 Wheel Truing Machines

The cost of a wheel truing program depends on the number of vehicles serviced and the interval between truing. The labor costs involved also depend greatly on the type of lathe used (above-floor versus below-floor), although the initial cost of the two types is comparable. Labor for above-floor lathes can be 3 to 7 times that for below-floor lathes. Another type of wheel truing machine is the below-floor milling machine, which is less expensive than the lathe and is considered by some shop personnel to be less accurate than the lathe. The use of below-floor milling machines is also considered by some transit personnel to require greater metal removal when trimming flanges than the use of the lathe-type machine. The capital cost necessary for a wheel truing program is approximately \$700,000 to \$1,500,000, with the lathes at the high end of the range. The lathes can be expected to last for at least 10 years and, assuming a 10% salvage rate, have a salvage value of \$100,000. For a system with 700

vehicles, the yearly cost for the program would be \$300,000 to \$400,000. As shown in Table 6-1, the EUAC for this program would be approximately \$472,000.

6.3.1.2 Dry-Stick Lubrication

Dry-stick friction modifiers and flange lubricators are gaining popularity at light rail transit systems for reducing rail wear and stick-slip. The costs for dry-stick lubrication vary. Because this treatment is still nascent, new products may be expected to come on the market and the cost of existing products might be expected to decline with increasing usage in the years to come. For these reasons, it is especially important to contact suppliers directly for accurate price quotes and product information.

Below is some cost information (1995) provided by several transit agencies and product suppliers. Metro-Dade County reports a capital cost of \$80,000 and maintenance cost of \$15,000 per vehicle per year. The EUAC for this system would be \$25,000 if it lasted 10 years and \$21,000 if it lasted 20 years. WMATA indicated that onboard flange and tread lubrication was estimated to cost about \$500 per truck per month, or about \$12,000 per vehicle per year. This agency did not relay any capital costs. One supplier indicates that the cost of combined flange lubricant and contact friction modifier

includes a one-time cost of \$800 to \$1,000 for brackets, plus 1 hr for installation time and a product cost of about \$1,500 per vehicle per year, assuming four wheels lubricated per vehicle. Based on a survey of various transit systems, the overall costs are \$1,400 per vehicle per year for friction modifier tread lubricant and \$1,200 per vehicle per year for flange lubricant. Thus, there appear to be wide disparities between costs of various onboard lubrication products. Costs should be reviewed with the manufacturer and verified.

6.3.1.3 Resilient Wheels

Resilient wheels include PCC, Acousta-Flex, Penn Bochum, and SAB. Costs range from \$1,600 to \$4,800 per wheel, or roughly \$13,000 to \$38,000 per vehicle. In general, there should be no extra yearly costs incurred with the use of resilient wheels relative to solid steel wheels. Many resilient wheels have replaceable treads and can be overhauled so that the tire centers can remain in service for decades. Costs for replacement treads are on the order of \$1,000 per tread plus mounting labor. The EUAC for a set of eight resilient wheels costing \$3,600 per piece and lasting 30 years, with two rebuilds, is approximately \$2,285 per vehicle per year, assuming the present value of a rebuild is \$1,000 per wheel. Assuming that a vehicle travels about 200,000 mi per year,

TABLE 6-1 COST DATA FOR ONBOARD TREATMENTS

Treatment	Capital Cost - \$ -	Maintenance Cost - \$/yr -	Material Cost/yr - \$/yr -	Salvage Value - \$	Useful Life - Yrs
Slip/Slide Control	5,000 - 10,000/veh	200	200	0	30
Wheel truing	1 mil	200	500	100,000	10
Vehicle skirts	5,500/veh	0	0	0	30
Undercar absorption	3,500 - 5,300/veh	0	0	0	30
Door seals	1,000/veh	100	0	0	10
Dry Stick Friction Modifier	500/veh ¹	300	1,400	0	30
Dry Stick Flange Lubricant	500/veh ¹	300	1,200	0	30
Resilient wheels	30,000/veh ²	1,000 ³	1,000 ³	100	30
Visco-elastic damped wheels	6,400 - 20,000/veh ²	0	0	0	30
Vibration absorbers	4,000 - 5,600/veh ²	0	NA	0	30
Ring dampers	560/veh ²	0	NA	10	10
Steerable trucks	8,000/veh	unknown	0	0	30

- Notes: 1 Cost based on installation of both flange lubrication and tread friction modifier stick holders at 4 wheels
 2 Assumes 8 wheels per vehicle. Costs for light rail articulated vehicles will be higher
 3 Based on \$1,000 per replacement tread and \$1,000 for labor.
 NA Not available

the cost per mile would be on the order of a penny per mile, which is comparable with the cost of automobile tires on a per-mile basis. (The above numbers are for illustrative purposes only and may not correspond to actual costs.)

6.3.1.4 Wheel Vibration Absorbers

Wheel vibration absorbers may cost between about \$500 and \$700 per wheel. There is no significant maintenance cost, though there may be a cost associated with removal of the absorbers from condemned wheels and remounting on new wheels. Salvage value may be considered nil. There may be a nonquantified cost savings in the way of reduced rail corrugation, though this has not been verified. The vibration absorbers can probably be reused, though this should be checked with the manufacturer. Replacement wheels should be machined and tapped to allow mounting of the dampers without the need for machining at the shop. Replacement wheels should be the same design as the original wheels, because the wheel vibration absorbers may be tuned to the specific modal resonances of the wheel. This may place a restriction on available wheel manufacturers, which might add to the cost of the wheels.

6.3.1.5 Visco-Elastic Dampers

Visco-elastic damped wheels include those which have visco-elastic ring dampers or constrained layer damping. Costs range from \$500 to \$2,000 per wheel, or \$8,000 to \$16,000 per vehicle. There are no maintenance costs, though there may be some nonquantified cost impact on wheel inspection or maintenance. Some researchers have assumed that the dampers may be reused once when wheels are replaced, though the cost to transfer the dampers is not known. The cost of transferring the dampers may be mitigated to some extent by having the manufacturer supply the wheels predrilled and machined, ready to accept the dampers. This would be facilitated if the dampers were originally supplied by the wheel manufacturer as part of a new wheel procurement. Salvage value of the dampers should be assumed nil, though the damper manufacturer might be interested in the metal or other reusable cores.

6.3.1.6 Ring Damped Wheels

Costs for steel ring dampers are on the order of \$30 to \$50 per wheel, including machining, when supplied as part of new wheel procurements. This damping treatment is perhaps one of the most economical and requires no maintenance, and dampers are relatively easy to replace, though replacement does not appear to be necessary. Ring dampers might also be reusable with suitably machined replacement wheels, though this should be checked. Salvage value is essentially the salvage value of carbon steel, unless they are reusable by other transit properties.

6.3.1.7 Undercar Absorption

Although undercar absorption yields only modest reductions in noise levels, it does have two strong advantages: it is relatively inexpensive, and its benefits are realized throughout the system. For simple application of glass fiberboard, the cost is \$10 to \$15 per square foot, or \$3,500 to \$5,300 per vehicle for 50% coverage. For 75% coverage the cost would be \$5,300 to \$7,900 per vehicle. If a high degree of shaping and/or protection were required, these estimates could increase substantially. There is no specific maintenance requirement, though there may be an impact on vehicle maintenance if the treatment is not placed judiciously.

Clear areas under the vehicle, over the trucks, are good locations. Areas over HVAC or other auxiliary equipment would probably not be accessible to treatment. Treatment, which can be applied to the interior surface of fixed or demountable skirts, would not impact vehicle maintenance. Plumbing and wiring should not be obscured, though these can be relocated, which would increase the cost of the treatment. There is no salvage value. Useful life should be equivalent to that of the vehicle, here assumed to be 30 years.

6.3.1.8 Skirts

In 1980 the cost of retrofitting a transit vehicle with two full-length skirts and undercar absorption was about \$12,000. Assuming a doubling of producer prices between 1980 and 1995, current costs would be roughly \$24,000. However, skirts and absorption would likely be part of an overall vehicle procurement and thus might be supplied at considerably lower costs than based on 1980 estimates. Vehicle skirts are being supplied with 27 articulated Tri-Met vehicles for a cost of about \$150,000, or about \$5,550 per vehicle or \$1,850 per truck. There are no maintenance costs associated with skirts, though there may be an increased cost associated with removal of the skirt for maintenance of the vehicle. There is no salvage value, other than that which might go with salvage of the vehicle.

6.3.1.9 Slip-Slide Control

Cost figures for slip-slide control are not easily obtained, primarily because slip-slide controls are standard equipment on many vehicles. GO Transit (Toronto) indicated that the cost of slip-slide control is \$2,500 per vehicle per year. Other estimates received by an older eastern rail transit system ranged from about \$5,000 to \$10,000 per vehicle for retrofit. Another East Coast transit system has received estimates of about \$5,000 per vehicle for retrofitting existing transit vehicles. Maintenance costs were not obtained. Salvage value should be assumed nil or, at most, scrap. Cylinders and actuators, however, may have some core value. Advances in technology may eliminate any salvage value for the electronic control systems. The useful life is assumed to be that

of the vehicle, here assumed to be 30 years. However, rebuilding of actuators and cylinders on a scheduled basis may be anticipated, though much of this cost may be necessary regardless of whether slip-slide control is employed.

6.3.2 Trackwork Treatments

Trackwork treatments include rails and rail support components and rail maintenance procedures such as rail grinding and joint tightening. EUAC estimates for all of the trackwork treatments discussed below are presented in Table 6-2.

6.3.2.1 Rail Grinding (In-House)

The cost of any rail grinding program depends on the number of track-miles to be maintained and the interval at which grinding is performed. An in-house grinding program can be economically efficient if sufficient grinding is done to warrant the capital expenditure necessary to instigate it. Most small- and intermediate-sized transit systems can operate a successful program with one grinding machine with between 8 and 20 grinding stones. In cases where grinding time is limited by nonrevenue periods, and lengthy grinding on a frequent basis is necessary to control rail corrugation, more than one grinder may be necessary.

The capital cost of a grinding machine depends on the number of grinding stones, track gauge, and support equipment (such as fire suppression systems). However, doubling the number of grinding stones cuts the grinding time in half, so that substantial labor cost savings might be obtained, and grinding during limited time periods will be facilitated by initially purchasing a 16- or 24-stone grinder rather than an

8-stone grinder. The cost of the equipment can also depend on special considerations such as clearance problems on some light rail systems.

Modern rail grinding machines have life expectancies of 10 to 15 years. Variable costs for rail grinding include labor (five-person crew), replacement of worn grinding stone sets, maintenance, and fuel. Initial capital costs for an in-house grinding program range from \$700,000 to \$1,300,000. Yearly operational costs vary between \$150,000 and \$300,000. For a \$1,000,000 program with \$200,000 in operational costs and a 5% salvage rate, the EUAC would be \$326,000 for yearly grinding. If grinding were done every 3 years, the EUAC would be \$189,000.

6.3.2.2 Rail Grinding (Contracted)

For those transit systems which do not grind often enough to warrant an in-house grinding program, contract grinding is an option. Estimates for contract grinding vary widely, from \$1,000 to \$7,000 per track-mile depending on the amount of track to be ground, grinding time availability, condition of the track and rail, and drayage costs. For a system with 140 track-miles, the average cost of grinding on a yearly basis would be \$560,000 (\$4,000 per track-mile). This is considerably more than the cost of running an in-house grinding program. If, however, grinding were to be done only once every 3 years, the EUAC for contract grinding would drop to approximately \$180,000, thus making contract grinding a feasible alternative to an in-house program. However, grinding intervals should be dictated by rail wear rates, because prolonging grinding may lead to increased rail material removal and excessive replacement cost to maintain low noise condition.

TABLE 6-2 TRACKWORK TREATMENT COSTS

Treatment	Initial Cost \$	Yearly Maintenance Cost \$	Yearly Material Cost	Salvage Value \$	Useful Life - yrs -
Rail Grinding (in house)	0.7 mil to 1.3 mil	0.27/tr-ft ¹	NA	0.05	10 to 15
Rail Grinding (contracted)	NA	NA	NA	NA	NA
Defect Welding & Grinding	NA	NA	NA	NA	NA
Joint Welding	4.1 mil	85/tr-ft	NA	0.1 mil	10
Joint Maintenance	0	0.35 to 0.50/tr-ft	NA	NA	NA
Lubrication	\$10,000/tr-curve	50,000/curve	\$200/tr-curve	0	15
Hard facing	30	Not available	Not available	0	2
Rail Vibration Absorbers	20 to 40/tr-ft	0	0	2	30
Rail Vibration Dampers	20/tr-ft	0	0	0	30
Trackbed Absorption	100/tr-ft	0	0	0	20

Notes: 1 Based on 1 year grinding interval for 140 miles of track at a cost of \$200,000 per year. Actual ground track per year will be considerably less.

NA Not available

6.3.2.3 Joint Tightening and Maintenance

Joint tightening to minimize gaps is expected to cost about \$7 per joint per year in addition to the cost of normal maintenance. There would be reduced rail joint impact and wear, which may reduce batter and extend track life.

6.3.2.4 Joint Welding

The costs of rail joint welding and finishing are expected to be about \$450,000 per track-mile, or \$85 per track-foot. For 39-ft rail sections, the cost would be about \$1,660 per rail joint. A cost of \$4,100,000 is estimated for the rail welding car, though this would likely be a contractor operation. More exact cost data should be obtained from rail contractors.

6.3.2.5 Hardfacing

The cost of hardfacing, whereby a very hard material is let into the rail head running surface to control rail wear and corrugation, ranges from \$15 to \$40 per rail-foot, or \$158,400 to \$422,400 per track-mile. The cost depends on how much rail is hardfaced. To date, most hardfacing applications within the United States and Canada were for rail wear control at curves and not for corrugation reduction on tangent track. Assuming 20% of a 140-track-mile system were hardfaced and that the hardfacing would last 10 years, the EUAC for this would be approximately \$1,165,000.

6.3.2.6 Trackbed Sound Absorption

Trackbed sound absorption may be an effective noise control measure for limited spacial applications such as stations and subways. Absorption in the form of 3-lb per cubic foot glass fiberboard encased in 3-mil-thick Tedlar, protected by perforated glass fiber or a powder-coated metal sheet, could be installed for a minimum cost of about \$10 per square foot. At this price, it would cost approximately \$300,000 to treat an underground station with a 750-ft-long platform (assuming treatment would extend half the length of the platform into the tunnel at each end of the station at each track and that the treatment width is about 10 ft wide). Note that ballast provides substantial sound absorption which may be very important in subways.

6.3.2.7 Defect Welding and Grinding

No data have been collected from transit systems on defect welding and grinding. Assuming a crew of four are required (flagger, welder, grinder, and supervisor), the cost of defect welding and grinding should about \$150 per hour. Assuming that the time required to weld and grind a defect is about $\frac{1}{2}$ to 1 hour, the cost per defect would be about \$75 to \$150 per

defect. If numerous defects exist, the cost should be balanced against rail replacement and or extensive rail grinding to remove defects. Equipment costs have not been determined.

6.3.2.8 Rail Vibration Absorbers

No cost data have been obtained for rail vibration absorbers. However, considering their size and design, costs could be on the order of \$50 to \$100 per absorber. Assuming that one absorber is installed every 5 ft (every other direct fixation fastener), the cost would be about \$20 to \$40 per track-foot. Maintenance should be negligible, though rail replacement would be complicated by the need to remove the absorbers. Tightening of absorber mountings might be necessary, analogous to normal joint maintenance. The absorbers should be reusable on new rail. Salvage value should be equivalent to that for scrap, unless they can be sold to another property. Useful life should be 30 years or more.

6.3.2.9 Rail Vibration Dampers

No cost data have been obtained for rail vibration dampers. However, their structure suggests a cost comparable to that of an inexpensive resilient direct fixation fastener consisting of a rolled plate and elastomer pad. Assuming that one damper is installed every 2.5 ft, or between successive direct fixation fasteners, the cost could be on the order of \$40 per track-foot. Salvage value at the end of its useful life, assumed to be 30 years, is likely equivalent to that for scrap steel. Scrap value of \$0.50 per damper is assumed, or about \$0.40 per track-foot.

6.3.3 Wayside Treatments

Wayside treatment costs are summarized in Table 6-3. Some of the wayside noise control options have a EUAC on the order of \$10 per foot of track, while rail grinding may be on the order of \$1 per foot, a considerable cost savings in favor of trackwork maintenance.

6.3.3. Station Sound Absorption Treatment

The cost for station sound absorption treatment is typically about \$10 per square foot, based on a design consisting of 1 to 2 in. of glass fiber sound-absorbing board with a perforated cover. However, special architectural designs, lay-in acoustical tile ceilings, etc., may be more costly. There is little maintenance cost, because the installations are considered permanent. There may be replacement costs as units become damaged as a result of other maintenance activities. There is no salvage value. Underplatform treatment will typically cost about \$10 per square foot for glass fiber sound absorbing board.

TABLE 6-3 WAYSIDE TREATMENT COSTS

Treatment	Initial Cost - \$ -	Yearly Maintenance Cost - \$/yr -	Yearly Material Cost - \$/yr -	Salvage Value - \$ -	Useful Life - yr -
Subway wall treatment	250/tr-ft ¹	0	0	0	30
Station treatment	7 to 10/sq ft	0	0	0	30
Fan and Vent shaft treatment	10/sq ft	0	0	0	30
Sound barrier walls	200/tr-ft ³	0	0	1/Sq ft	30
Berms	200/tr-ft ³	NA	0	1/Sq ft	30
Receiver treatments	200 to 800/tr-ft ²	NA	0	0	30

Notes: 1 Based on upper half of 17 foot diameter circular tunnel treated at \$10/sq.ft.
 2 Assuming one receiver every 25 feet (densely populated) at \$5,000 to \$20,000 per receiver.
 NA Not available

6.3.3.2 Subway Wall and Ventilation Shaft Treatments

Subway wall treatment consisting of spray-on cementitious sound absorption typically costs on the order of \$7 to \$10 per square foot, installed. There are no maintenance costs or salvage value. Useful life should be 20 to 30 years.

6.3.3.3 Sound Barriers

Costs for sound barriers are on the order of \$15 to \$20 per square foot and vary according to local labor and material costs. Barrier heights range from 6 to 12 ft depending on proximity to the track. Per 100 ft of a 9-ft-high wall, the construction cost would be around \$16,000. Such a wall can be expected to last 30 years or more; therefore, the EUAC per foot of wall is approximately \$10.

6.3.3.4 Receiver Treatments

Receiver treatments include enhancing the building facade and provision of forced air ventilation or air conditioning. There may also be instances in which interior noise control is advisable. The costs associated with receiver treatments range from about \$5,000 per dwelling to \$20,000 per dwelling, depending on whether forced ventilation is required, the number of windows treated, local codes, labor rates, and material costs. Also, there may be unknown costs related to pest damage and operating costs of forced air ven-

tilation. For these reasons, receiver treatment should be the last treatment to consider.

6.4 REFERENCES

1. Kurzweil, L. G., R. Lotz, and E. G. Apgar, *Noise Assessment and Abatement in Rapid Transit Systems* (Report on the MBTA Pilot Study), Transportation Systems Center, Urban Mass Transportation Administration, U.S. Department of Transportation, UMTA-MA-06-0025-74-8 (September 1974), pp. 3-10.
2. Kurzweil, L. G., and L. E. Wittig, *Wheel-Rail Noise Control—A Critical Evaluation* (Interim Report), prepared by Bolt Beranek & Newman, Inc., for Transportation Systems Center, Urban Mass Transportation Administration, U.S. Dept. of Transportation, UMTA-MA-06-0099-81-1 (January 1981), pp. A-2.
3. Saurenman, H. J., R. L. Shipley, and G. P. Wilson, *In-Service Performance and Costs of Methods to Control Urban Rail System Noise* (Final Report), prepared by Wilson, Ihrig & Associates, Inc., and DeLeuw Cather & Co. for Transportation Systems Center, Urban Mass Transportation Administration, U.S. Dept. of Transportation, UMTA-MA-06-0099-80-1 (December 1979), pp. 6-1 to 6-8.
4. Shipley, R. L., and H. J. Saurenman, *In-Service Performance and Costs of Methods to Control Urban Rail System Noise* (Initial Test Series Report), prepared by Wilson, Ihrig & Associates, Inc., and DeLeuw Cather & Co. for Transportation Systems Center, Urban Mass Transportation Administration, U.S. Department of Transportation, UMTA-MA-06-0025-78-7 (August 1978).
5. Manning, J. E., *In-Service Evaluation of Four Types of Damped Subway Car Wheels* (Unpublished Report), Cambridge Collaborative, March 22, 1985.

This page left intentionally blank.

CHAPTER 7 ONBOARD TREATMENTS

- 7.1 Introduction, 105
- 7.2 Wheel Truing, 105
 - 7.2.1 Wheel Truing Machines and Manufacturers, 105
 - 7.2.2 Noise Reduction Effectiveness, 106
 - 7.2.3 Wheel Tread Profiles, 106
 - 7.2.4 Cost-Benefit Considerations, 107
- 7.3 Braking Systems, 107
- 7.4 Traction Fault Detection and Slip-Slide Control, 107
 - 7.4.1 Effectiveness in Preventing Wheel Flats, 108
 - 7.4.2 Costs, 108
- 7.5 Resilient Treads, 108
 - 7.5.1 Performance, 108
 - 7.5.2 Costs, 109
- 7.6 Damped Treads, 109
- 7.7 Nitinol Tread Wheels, 109
 - 7.7.1 Noise Reduction Performance, 109
 - 7.7.2 Wear Reduction Performance, 109
 - 7.7.3 Costs, 109
- 7.8 Resilient Wheels, 110
 - 7.8.1 Products, 110
 - 7.8.2 Noise Reduction Effectiveness, 112
 - 7.8.2.1 Tangent Track Performance, 112
 - 7.8.2.2 Curved Track Performance, 113
 - 7.8.3 Site-Specific Conditions, 114
 - 7.8.3.1 Tread Brakes, 114
 - 7.8.3.2 Disk Brakes, 115
 - 7.8.3.3 Truck Shock and Vibration Reduction, 115
 - 7.8.3.4 Corrugation, 115
 - 7.8.4 Costs, 116
- 7.9 Damped Wheels, 117
 - 7.9.1 Products, 117
 - 7.9.2 Noise Reduction Effectiveness, 119
 - 7.9.2.1 Products, 119
 - 7.9.2.2 Site-Specific Conditions, 121
 - 7.9.2.3 Costs, 122
- 7.10 Undercar Absorption, 122
- 7.11 Skirts, 122
- 7.12 Steerable Trucks, 123
- 7.13 Soft Versus Stiff Primary Suspensions, 123
- 7.14 Onboard Lubrication, 124
 - 7.14.1 Flange Lubrication, 124
 - 7.14.2 Oil Drop and Spray Systems, 124

- 7.14.3 Dry-Stick Lubricants, 125
 - 7.14.3.1 Systems Using Dry-Stick Lubricants, 125
 - 7.14.3.2 Manufacturers, 125
 - 7.14.3.3 Noise Reduction Effectiveness, 125
 - 7.14.3.4 Costs, 130
 - 7.14.3.5 Site-Specific Conditions, 131
 - 7.14.3.6 Application Techniques, 132
- 7.15 Car Body Sound Insulation, 132
 - 7.15.1 Vehicle Procurement Specifications, 132
 - 7.15.2 Sound Transmission Loss Requirements, 133
 - 7.15.3 Car Body Designs, 134
 - 7.15.4 Doors, 135
- 7.16 References, 137

CHAPTER 7

ONBOARD TREATMENTS

7.1 INTRODUCTION

This chapter discusses various vehicle treatments for controlling wheel/rail noise. Much of the information is based on work conducted by UMTA (now FTA) during the late 1970s and early 1980s, a period that may be termed the “golden age” of rail transit noise control research. This early work concerned primarily wheel truing, slip-slide control, resilient wheels, and damped wheels. Vehicle noise control has advanced marginally since the 1970s, though noise control investigations have been continued by various operating agencies, and papers have appeared in the literature from time to time.

Treatments or provisions which may now be considered standard at modern rail transit systems include wheel truing and provision of slip-slide control systems, which, in combination with effective rail grinding, result in low levels of wheel/rail rolling noise on tangent and moderately curved track. With these basic noise control provisions, wheel/rail rolling noise is normally not a significant environmental problem. There remains, however, wheel squeal, for which no entirely satisfactory solution has yet been developed. Resilient wheels, damped wheels, and flange lubrication have been developed to address wheel squeal, all of which provide some degree of control.

The car body design, though not normally considered with respect to wheel/rail wayside noise (I), is very important in controlling vehicle interior noise, especially in subways, where wheel squeal and howl caused by stick-slip vibration of the wheels and rail corrugation are capable of reaching 100 dBA within the vehicle. Vehicle skirts recently have been provided with some new transit vehicles, such as at the Denver system, though there is little other experience with this type of treatment, and the degree of noise reduction is limited to a few decibels.

Recently, researchers experimented with active noise control to reduce car interior noise. The success and practicality of active noise control remains to be seen, given the complexity and distributed nature of wheel/rail interaction. Nevertheless, active noise control treatments bear watching. For example, there are certain piezo-electric damping treatments that might be useful in controlling wheel squeal. This manual describes the characteristics and performance of various treatments that may be applied to a transit vehicle, whether

standard or not, relying on published reports, general literature, and in-house data collected by the authors.

7.2 WHEEL TRUING

Wheel truing is the front-line defense against wheel/rail noise. Without an effective wheel truing program, transit system efforts at noise control are severely hampered, and substantial additional cost beyond that which might reasonably be expected for a well-maintained transit system would be required. Without wheel truing, rolling noise levels are roughly 5 to 10 dB above normal rolling noise levels of well-trued wheels and smooth ground rail. Additional noise control provisions such as sound barriers and receiver treatments might be needed if wheel truing (and rail grinding) are not performed. Higher sound barriers and more effective sound insulation of dwellings might be required at systems with poorly maintained wheels than at systems that are well maintained. Wheel truing has systemwide effectiveness and thus may provide greater benefit per dollar than a fixed noise control treatment. There are also ancillary benefits to wheel truing which should not be ignored, such as control of ground-borne noise and vibration, improved truck dynamics, and reduced wear.

7.2.1 Wheel Truing Machines and Manufacturers

There are three types of commercially available wheel truing machines. One type is a lathe which cuts material from the wheel tread with a stationary cutting bar as the wheel rotates about its axis, represented by the Hegenscheidt wheel truing lathes. The second type of wheel truing machine is based on a milling machine concept, which removes tread material with a rotating cutter head held in a stationary position as the wheel rotates incrementally. An example is the Simpson-Stanray milling machine, an underfloor milling machine which does not require removal of the wheel or axle set for truing. A third type is the belt grinder, which has been used by TTC. BART experimented with the belt grinder during or before startup, but was unable to make it work successfully. Noise reduction performance data for belt grinders were not obtained for this study and are not considered further.

Wheel truing accuracy has a direct bearing on wheel/rail noise control, for two reasons. The first is that uneven cutting will increase wheel/rail noise and groundborne noise and vibration. The second is that wheels not trued to the same dimensions will be subject to excessive slip and wear, thus increasing wheel roughness and noise. This is particularly important with respect to monomotor trucks, where all four wheels must be trued to exacting tolerances.

The lathe is considered by some transit vehicle maintenance engineers to be the most accurate of the wheel truing machines. However, the milling machine is usually less expensive than the lathe and is reasonably efficient to operate. A discussion with BART engineers indicated that truing with the lathe type of truing machine requires less metal removal than truing with the milling type of machine when trimming flange throats.

7.2.2 Noise Reduction Effectiveness

Wheel truing tests at SEPTA indicated measurable and consistent reductions of noise on both tangent and curved track. Wheels trued with an under-the-floor milling machine were 0 to 2 dBA noisier than new wheels trued with a lathe, considered at the time to be the result of the cutter marks left by the cutting bar. The effect of the cutting marks on noise levels lessened after a few days of running. The cutting marks left by a milling-machine-type truer are on the order of a fraction of $\frac{1}{8}$ in. in dimension, so that the frequency of any noise associated with the cutting marks should be in excess of 5,000 Hz at normal vehicle speeds. Further, more recent measurements conducted at BART indicate that wheels trued with a milling-machine-type truer are no noisier than wheels trued with BART's wheel truing lathe.

Tri-Met employs a Hegenscheidt wheel truing lathe to true each wheel on a semiannual basis. Tri-Met uses Bochum 54 resilient wheels on Bombardier vehicles. Noise levels are maintained at about 80 dBA at 50 ft from tangent ballast-and-tie track for 55-mph two-car trains when the rail is in good condition, without corrugation.

On rough rail, the full noise reduction benefits of wheel truing are not fully realized, because the roughness of the rail dominates the noise generation process. However, wheel truing will still produce noise reductions on unground rail that is in good condition, free of corrugation and other surface defects. This is especially true if the untrued wheels have wheel flats and other surface defects.

The SEPTA tests at curved track showed that wheel squeal levels with new and trued wheels are essentially equivalent, suggesting that wheel truing as performed by SEPTA has little effect on wheel squeal.

Maintaining a wheel truing schedule sufficient to control wheel roughness and reduce wheel concavity, or false flanging, and operating it with a well-trained and conscientious machinist is likely to be more important with respect to noise control than the actual type of wheel truing machine, though

one should consider metal removal rates for each type of machine and the type of truing required. Systems which have numerous curves may experience a greater degree of flange wear as opposed to tread wear and thus require trimming of the flange on a relatively frequent basis. In this case, the lathe type of truer might be the most economical if it removes less material than the milling-machine-type truer. Manufacturers should be questioned closely on the characteristics of their types of machines before making a final selection. Larger systems may wish to consider having both types of truing machines.

7.2.3 Wheel Tread Profiles

The effect of wheel tread profile on wheel rail noise is not clearly known. The principal concern in selecting a tread profile should be minimizing rail corrugation rates, optimizing the contact patch geometry and stiffness, obtaining acceptable ride quality, and controlling wheel and rail wear. Increasing the wheel taper is usually associated with an increase in possibly undesirable hunting of the truck. (BART uses a cylindrical wheel profile to effectively eliminate hunting.) The wheel tread and rail head profile control the contact patch size and shape, which in turn have an effect on corrugation growth rates, fatigue, and possibly spin-slip or roll-slip motion of the wheel. For example, squaring up the contact patch so that the lateral dimension is comparable with the longitudinal dimension has been claimed to reduce corrugation growth rates at the Vancouver Skytrain by reducing spin-slip corrugation (2). The Skytrain system employs a UTDC steerable truck with small diameter conical wheel treads. The conical taper has been conjectured to excite spin-slip motion in the presence of high wheel/rail conformity, and reduction of conformity by rail grinding and wheel truing appears to be beneficial.

Contact width is believed to influence rolling noise at tangent track, regardless of corrugation, as discussed in Chapter 10. One school suggests that wide contact widths induce spin-creep noise, while another school indicates that wide contact widths tend to average out rail roughness across the rail head.

Measurements at BART suggest that a narrow contact width is most desirable. The wayside noise produced by a single BART vehicle traveling at 80 mph on tangent ballast-and-tie track with smooth ground rail is about 80 dBA at 50 ft, making the BART vehicle one of the quietest. In fact, the wheel/rail noise component is comparable to noise from other sources such as the traction motors, cooling fans, and aerodynamic sources under the car. This conclusion is based on data taken at the BART Hayward test track, where the rail head was ground to produce a contact patch width of about $\frac{5}{8}$ in., and measurements indicated that the rail head ball radii were 8 in. and 11 in. The narrow contact width and the cylindrical tread profile used by BART limit spin-torques, thus limiting spin-slip. The small contact patch area also reduces

the contact patch stiffness, which further reduces noise above the contact resonance frequency. Tread wear will produce a certain degree of concavity in the tread profile which will increase wheel/rail conformity, as is readily observable at BART mainline track. Maintaining a narrow contact width may not be practical without frequent wheel truing.

Conversely, theoretical analyses indicate that the roughness averaged over the rail head with wide conformal contact is lower than with a narrow contact width (3). The reduction of average roughness is of greater significance with respect to reducing rolling noise than reducing contact stiffness by reducing the contact width, as described in Chapter 4. Wear and corrugation rate reduction should be overriding concerns in selecting contact patch size and shape, because both of these adversely affect wayside noise levels.

The contact strip should be centered over the rails' cross-sectional center of gravity to minimize vibration couples acting on the rail. This would reduce the tendency of the rail to undergo bending of the rail web and thus reduce noise associated with this mode of vibration. However, at least one system (Vancouver Skytrain) chooses to vary the contact strip position to reduce rutting of the wheel tread. Using a cylindrical wheel with a canted rail, such as used at BART, tends to shift the contact patch to the field side of the rail head, thus inducing lateral bending vibration of the rail web.

Wheel squeal at large radius curves can be controlled to some extent with conical wheel treads and longitudinal compliance in the primary suspension. During curving, a rolling radius differential may be developed with conical tapers and may allow the high rail wheel to travel faster than the low rail wheel, thus reducing or eliminating longitudinal creep. However, wheel squeal is caused primarily by lateral slip, in turn caused by crabbing of the axle set, as discussed in Chapter 4. To control lateral slip, some longitudinal compliance is required in the journal suspension to allow the axles to align themselves with the curve radius and reduce lateral slip. For radii greater than about 700 to 800 ft, wheel squeal from typical transit vehicles is not expected, regardless of tread profile, due to the nature of the friction-creep curve. Regardless of curve radius, systems with cylindrical wheel treads may experience greater incidence of wheel squeal and roll-slip-induced rolling noise than systems with tapered wheel treads.

7.2.4 Cost-Benefit Considerations

Wheel truing results in greater wheel tread life, lower truck shock and vibration, and lower wheel/rail noise. This translates directly into longer life cycles for wheels, reduced maintenance of trucks and truck-mounted equipment, reduced ballast pulverization, reduced maintenance of trackwork, and lower noise mitigation costs. The benefits of wheel truing are supported by the fact that almost every major rail transit operator has an effective wheel truing program. Costs for wheel truing machines are discussed in Chapter 6.

7.3 BRAKING SYSTEMS

Substantial noise level differences exist between vehicles with tread-braked systems and disc-braked systems. Further, slip-slide control systems provide an effective tool for maintaining wheel condition, thus minimizing noise and maintenance costs.

Noise levels for tread-braked systems are reported to be about 10 dB higher than for disc-braked systems, due to wear of the tread caused by brake shoes. Composition tread brakes roughen the wheel tread less than cast iron tread brakes and thus produce about 3 to 5 dBA lower noise levels than cast iron tread brake systems (4, 5).

Recent data collected for intercity trains in Europe indicate a direct correlation between wheel roughness and noise measured at 0.5 and 1 m from the near rail at about rail height. Some of the results of 1/3-octave band data are presented in Figure 7-1 for 89-mph trains measured after varying periods of wear. The data are not entirely representative of wayside noise, because efforts were made to exclude rail radiated noise. The data indicate that vehicles relying solely on disc brakes produce the lowest rolling noise levels. A close second, however, are vehicles with disc brakes and sintered tread brake blocks. The sintered blocks produced a concave wheel tread surface which was suggested as a reason for the slightly higher noise levels relative to those for the disc-brake-only system, even though the wheel running surface appeared to be smoother for the disc- and sintered-block-braked vehicles than for the disc-brake-only vehicles. Surprisingly, vehicles with disc and cast iron block brakes produced higher noise levels than vehicles with cast iron block brakes only. The peak at about 630 Hz for vehicles with disc and cast iron brakes is related to polygonalization of the tread at a wavelength of about 6.3 cm (6).

Experience to date suggests that vehicles with disc brakes only have the smoothest wheel treads and produce the lowest levels of noise compared with vehicles with tread brakes of any type.

7.4 TRACTION FAULT DETECTION AND SLIP-SLIDE CONTROL

Traction fault detection and slip-slide control systems are particularly effective in inhibiting formation of wheel flats, especially in wet weather, where friction braking can easily lock wheels and induce slip. Thus, traction fault detection and slip-slide control systems are some of the most effective means available to the vehicle manufacturer to control wheel flats and, thus, rolling noise (7). Traction fault detection systems have been used on at least 30 older MTA NYCT vehicles and are designed to reduce slip during braking by monitoring and servoing both brake cylinder pressure and motor currents. Slip-slide or spin-slide control systems monitor axle speeds and adjust braking or tractive effort on each axle to equalize axle speeds and thus control slip during both

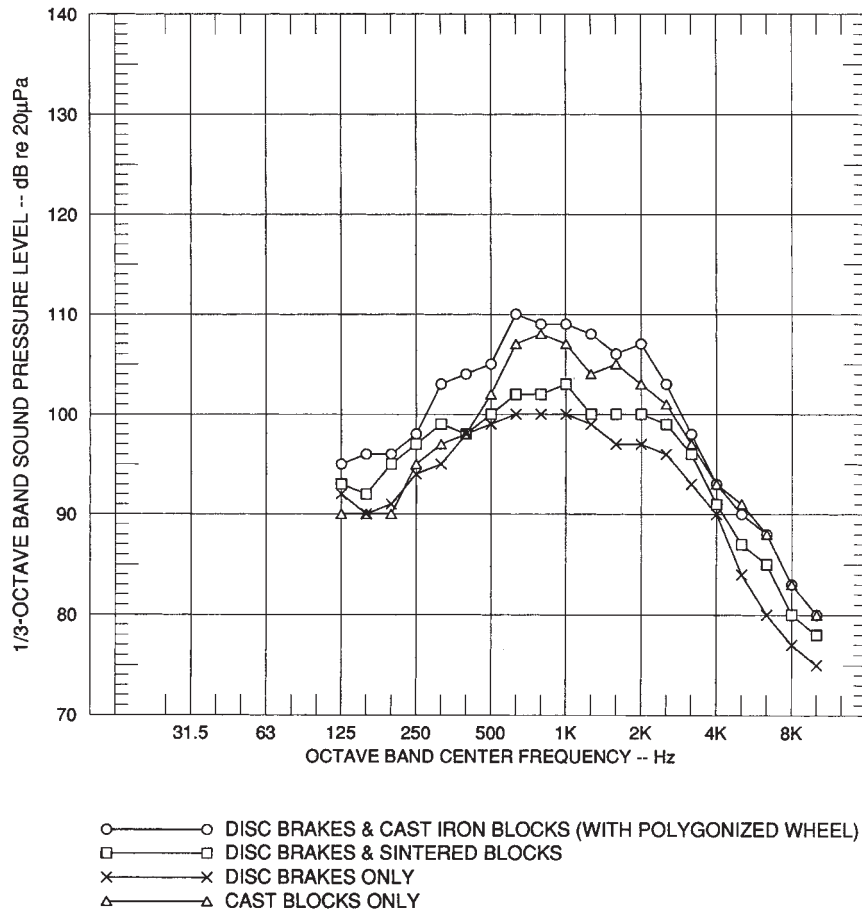

FIGURE 7-1 EFFECT OF BRAKING SYSTEMS ON WHEEL/RAIL ROLLING NOISE - AVERAGE NOISE LEVELS AT 0.5 AND 1 METER FROM NEAR RAIL OF 89 MPH INTERCITY TRAINS

braking and acceleration. Slip-slide control systems are thus more advanced than traction fault detection systems.

7.4.1 Effectiveness in Preventing Wheel Flats

The MTA NYCT reports that 50% fewer wheel flats occur with both traction fault detection systems and slip-slide control systems (survey questionnaire) (8). Metro Dade County reports that its slip-slide control system is not 100% effective and that small flats occur at times (survey questionnaire). Other transit systems may experience less than 100% effectiveness. A 50% reduction of wheel flat occurrence translates to a 50% reduction in wheel truing effort and a significant increase in tread life. Frequent wheel truing may result in excessive removal of tread material, thus reducing tread life.

7.4.2 Costs

The costs for dynamic brake control systems with traction fault detection or slip-slide control systems are not easily determined, primarily because these braking systems usually

come standard with the vehicle; thus their costs are not broken out. SEPTA indicates that the costs for a microprocessor controlled system with active sensing is \$10,000 per vehicle, though they are in a bidding process for the system (9). The MBTA has recently received bids for slip-slide control retrofits of between \$5,000 and \$10,000 per vehicle. A cost of \$10,000 per vehicle should be assumed unless other data are obtained to the contrary.

7.5 RESILIENT TREADS

Resilient treads have been proposed to reduce contact stiffness and thus vibration and noise (10). The resilient tread consists of a steel band surrounding the wheel rim. A portion of the rim is relieved by machining a channel, which is bridged by the tread, as shown in Figure 7-2. The resilience is caused by bending of the tread over the relieved area.

7.5.1 Performance

Resilient treads have been considered theoretically and experimentally under laboratory conditions, but no practical

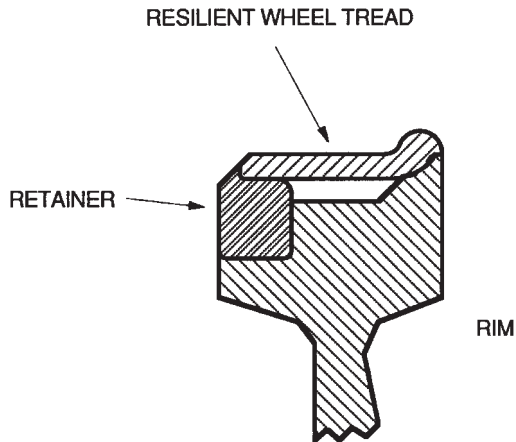

FIGURE 7-2 RESILIENT TREAD DESIGN (REMINGTON, 1983)

examples of resilient tread technologies for rail application have been implemented. From a theoretical perspective, greater compliance at the wheel contact area may result in lower noise levels at high frequencies, and laboratory tests with rolling rigs indicate that the A-weighted noise radiated by wheels fitted with resilient treads is reduced in level by 3 to 6 dB (11).

7.5.2 Costs

Cost data have not been obtained for resilient tread designs. Costs would include additional machining of the tire, including drilling and tapping, and addition of the resilient tread and retaining rings. Costs may be offset to some extent by replacing the tread, rather than by grinding. However, the tires would still be subject to flange wear, which might limit tread life. The flange and tread cannot be turned or milled to a significantly smaller diameter, thus decreasing the life of the tire. There may be possibilities for improving the design, however. For instance, the tread and flange might be forged as an integral unit, so that both tread and flange would be removed together. An added feature is that wheel truing might no longer be needed, because a wheel could be reconditioned simply by changing the tire in situ. The tread would then be salvaged, and the material might be reused in forging new treads. (Replaceable tires are a selling point for resilient wheels such as the Bochum 84 or SAB wheels.) Further, wheel diameters would be carefully controlled by tread replacement rather than by truing. Considering the cost of truing, including labor and capital expenditure, there may be some cost advantages associated with a replaceable resilient tread over conventional wheels.

7.6 DAMPED TREADS

High damping alloys have been investigated as a means of controlling contact patch resonance and corrugation. There

has been some success demonstrated in roller rigs in the laboratory, though there has been no field application to date (12). High damping alloys for treads are not considered a practical noise control option for the purposes of this project.

7.7 NITINOL TREAD WHEELS

A nickel-titanium (Nitinol) tread consists of a band of Nitinol alloy measuring, perhaps $\frac{3}{8}$ in. thick by 2 in. wide, as illustrated in Figure 7-3. Nitinol is a superelastic material which has a lower modulus of elasticity than steel, can undergo considerable recoverable strain, and has a negative coefficient of thermal expansion (13). This potentially exciting material deserves additional study and testing for transit application.

7.7.1 Noise Reduction Performance

Nitinol alloy treads have been studied theoretically and evaluated under laboratory conditions with a roller rig to determine their potential for reducing rolling noise (14). The laboratory tests indicate that Nitinol treads may reduce wheel/rail rolling noise by 3 to 5 dB relative to standard steel wheels. Of particular value may be elimination of stick-slip vibration at curves, which may substantially reduce or eliminate wheel squeal (15).

7.7.2 Wear Reduction Performance

The Nitinol treads were produced by Raychem Corp. and subjected to laboratory evaluation of wear and friction-creep characteristics at the Illinois Institute of Technology (16). Nitinol provides a lower material modulus, thus reducing contact stiffness, and improves wheel/rail adhesion by way of greater wheel/rail conformity and resistance to lubricating effects of rail surface contamination. The effectiveness of Nitinol as a wear-resistant material has not been demonstrated in transit application, but laboratory tests indicate that wear is reduced with the Nitinol tread by way of contact stress reduction.

7.7.3 Costs

The costs of Nitinol in 1978 was about \$500/lb, thus making it relatively expensive compared with other noise control provisions. Today, costs are considerably lower, about \$20 to \$50/lb, making the material cost of a 30-in.-diameter Nitinol tread about \$350 to \$860. Machining costs are probably about \$20 per tread, so that the overall cost per tread would range between \$400 and \$1,000 per tread. The replacement rate due to wear is not known, though the wear properties are claimed to be excellent. The tire is likely to be condemned due to normal flange wear rather than wear of the Nitinol tread. A Niti-

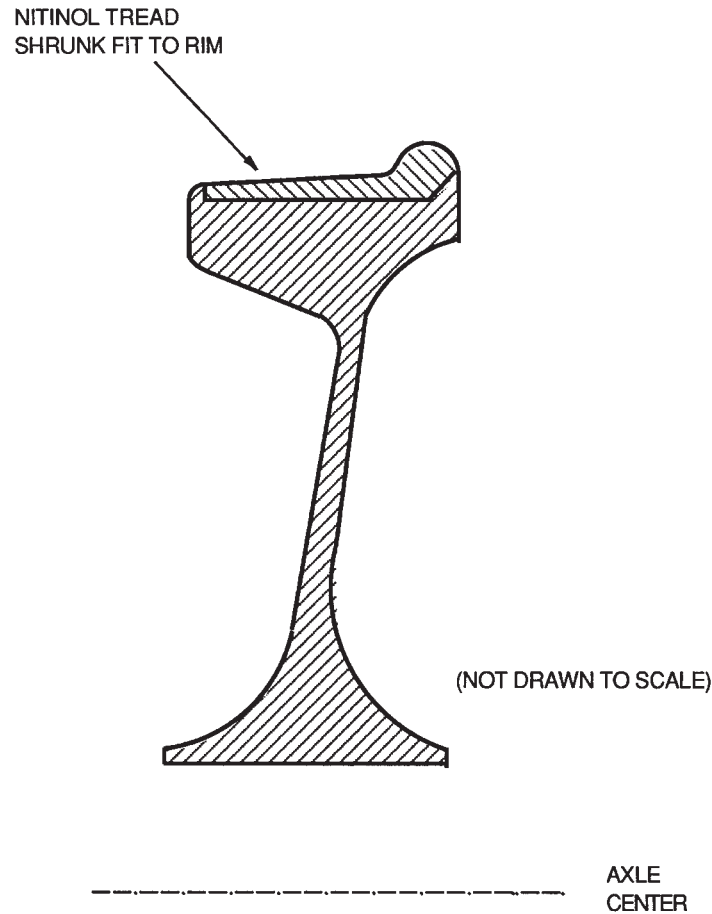

FIGURE 7-3 CONCEPTUAL DESIGN OF NITINOL TREAD

nol tread with integral flange may be attractive and could be replaced rather than trued by conventional techniques.

As with the resilient tread design discussed above, wheels might be reconditioned simply by replacing the tread. In this case, the reconditioning process would involve cutting the existing tread from the rim, cryogenically cooling a new tread, expanding the supercooled new tread with a hydraulic tread expander, placing the new tread over the wheel rim, and allowing the tread to come to room temperature, whereupon it shrinks over the rim, ensuring a snug mounting, without retainers and mounting bolts. This would represent a major change from conventional shop practice, for which cost impacts are not known. Cost impacts may well be favorable.

7.8 RESILIENT WHEELS

Resilient wheels are used on many light rail transit vehicles and some heavy rail transit vehicles for reducing wheel squeal at curves. Resilient wheels are constructed with a resilient element between the tire and wheel center. The resilient wheel is particularly effective in reducing wheel squeal noise, because the material damping of the elastomer

springs may overcome the negative damping of the friction force versus creep velocity characteristic. In addition, the tread of the resilient wheel is not rigidly constrained, so that the tread may follow the rail without undergoing lateral slip for significant distances, thus preventing stick-slip vibration. The resilient element also offers some vibration isolation between the tire and wheel center, which may be beneficial in reducing noise, if only slightly, and reduces the unsprung mass of the wheel set at frequencies between about 100 and 500 Hz.

7.8.1 Products

There exist a number of suppliers of resilient wheels, attesting to their success and acceptance in the industry. Examples include the Presidents Conference Committee (PCC), Bochum, SAB, and Acousta-Flex wheels. The Bochum and SAB wheels are used widely in the United States by light rail transit vehicles. The various wheels that have been incorporated at transit systems are described below.

Presidents Conference Committee (PCC) Wheels. The PCC wheel, the first resilient wheel, was constructed of steel

discs and rubber inserts intended to reduce shock and vibration impacts on vehicle trucks, or bogies. The wheel was introduced by the PCC of the American Transit Association. The PCC wheel was employed on the PCC cars used at many street car systems throughout the United States, but was not used widely on other vehicles.

Variants of the PCC wheel include the Penn Machine Co. PCC Standard Resilient Wheel with $\frac{3}{16}$ -in. static deflection and the PCC Super Resilient Wheel with $\frac{3}{8}$ -in. static deflection, achieved by employing rubber in shear. This degree of deflection causes heat buildup in the elastomer, with a possible loss of rolling efficiency at high speeds and heavy loads, and possible failure when tried on heavy rail subway systems (17). However, the Chicago CTA, the MTA NYCT, and other systems have had success with these wheels. The Chicago CTA replaced the PCC wheels with solid wheels because of cost and parts availability, rather than problems with reliability (18).

Acousta Flex. The Acousta Flex wheel, developed by Standard Steel, working with the Bay Area Rapid Transit District (BART) in the mid 1960s, features a 6061-T6 aluminum alloy center threaded with a carbon steel rim with silicone rubber elastomer separating the rim and center in the threaded area, as illustrated in Figure 7-4. The design is

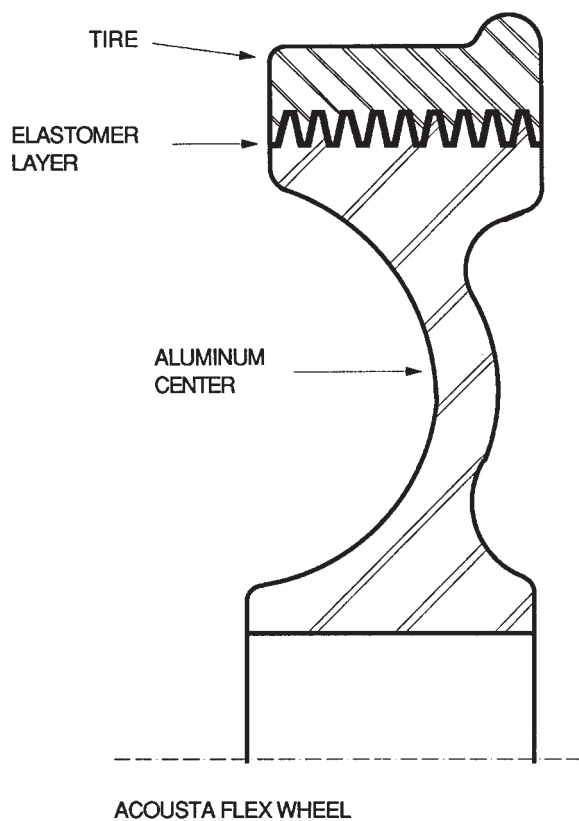

FIGURE 7-4 ACOUSTA FLEX RESILIENT WHEEL TESTED AT BART

completed with a carbon steel tire shrink-fitted to the rim, electrical shunts, and a steel locking ring. The tire may be removed and replaced with another to extend service life of the wheel. The silicone rubber is $\frac{3}{16}$ in. thick and is injected into the threaded region between the center and rim.

The Acousta Flex wheel was mounted on the State-of-the-Art-Car (SOAC) developed by the UMTA and was delivered to light rail transit systems at San Francisco and Boston. A set of Acousta Flex wheels was mounted on Car 107 for testing at BART and was subjected to revenue service at BART on a single vehicle for a number of years.

Bochum. The Bochum resilient wheel, illustrated in Figure 7-5, was initially developed in Europe by Bochumer Verein A.G. (a subsidiary of Fried Krupp Huttenwerke A.G.) and is one of the most widely used of the resilient wheels at U.S. transit systems. The Penn Bochum radial deflection is designed to be on the order of 0.040 in. to 0.050 in., primarily to reduce shock and vibration of axle and truck-mounted equipment, based on work conducted for the PCC. Penn Machine Co. is licensed to manufacture and/or distribute the wheel in the United States. The Bochum wheel comes in two types: the Penn Cushion Wheel Bochum 54 and the Penn Bochum 84.

The Penn Cushion Wheel Bochum 54 employs rubber blocks in compression between a steel tire and aluminum center. The rubber elements are not vulcanized to the rim or tire. Internal electrical shunts are incorporated between the tire and rim, though some systems provide an external strap between the tire and rim, which eliminates the possibility of pitting of the interior surface of the tire caused by electrical arcing or resistive heat buildup. There is a concern that pitting would introduce stress concentrations and possibly contribute to fatigue of the tire. SEPTA has observed that there appear to be problems with the electrical continuity caused by failure of electrical leads resulting from tire rotation. BART has run a set of Bochum wheels with external shunts for several years on a single car without difficulty. The Bochum wheel weighs considerably less than a standard wheel, because of the aluminum center.

The Penn Cushion Wheel Bochum 84 is similar to the Bochum 54, except that a removable ring is employed to retain the elastomer and tire tread, thus allowing retreading without pressing the wheel from the axle or requiring demounting of the truck and axle. The manufacturer indicates that the Bochum 84 tire may be removed entirely with hand tools. The Bochum 84 wheel is currently used by the MBTA and will be used by the Portland Tri-Met for the center trucks of the new low-floor-height vehicles now in procurement. The tire of the Penn Bochum wheel may be returned to the factory for replacement when worn excessively.

Some of the more interesting and noteworthy benefits of the Bochum wheel are listed by the manufacturer's representatives as follows (19):

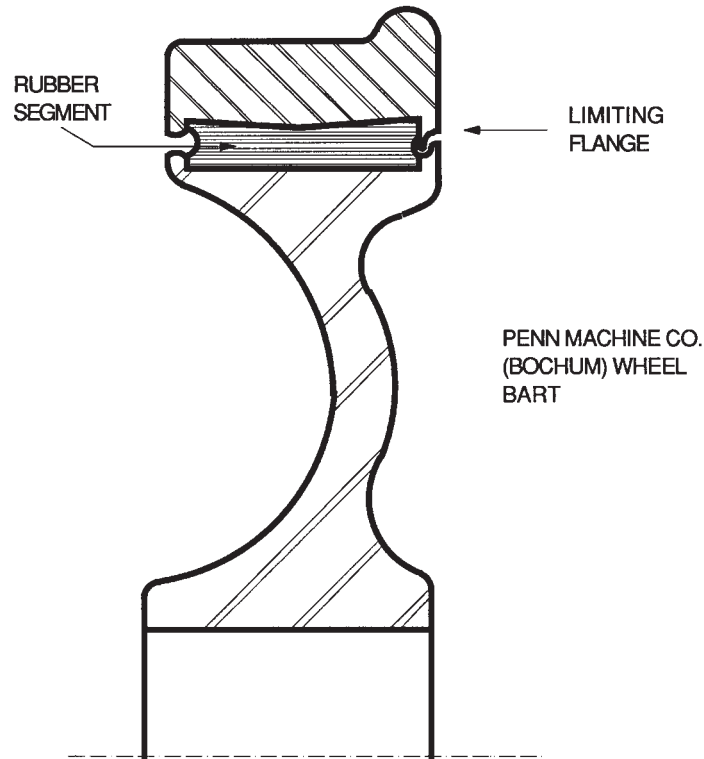

FIGURE 7-5 BOCHUM WHEEL USED AT BART ON CAR 107

- High-frequency squeal almost completely eliminated at curves in excess of 100-ft radius,
- Substantial elimination of flat spotting,
- Substantial reduction of impact forces,
- Reduction of flange and rail (gauge face) wear,
- Annular spring effect on acceleration and braking,
- No recorded cases of rail corrugation, and
- No recorded wheel failures of the 50,000 in use as of 1975. (A failure was reported for tread braked vehicles at SEPTA during testing (20).)

In contradiction to no recorded cases of rail corrugation, rail corrugation has been observed on embedded girder rail and ballasted track with 115-lb/yard rail at the Portland Tri-Met. SEPTA has also observed rail corrugation at embedded track.

The above list is impressive and deserves further evaluation before selection by a particular transit system. For example, rail corrugation is a common occurrence at many light rail transit systems employing resilient wheels, including the Bochum wheel, though corrugation has not been attributed directly to the resilient wheel.

Penn Super Cushion Wheel. The Penn Machine Co. provides a high compliance resilient wheel featuring a rubber-in-shear isolator. The design is in use at the Greater Cleveland RTA, SEPTA, and Toronto Transit UTDC systems. No performance data have been obtained for this wheel.

Bochum Composite Resilient and Damped Wheel. VSG also provides a vibration absorber system which is attached to the wheel tire to augment the squeal noise reduction effectiveness of the Bochum resilient wheels. No test data have been obtained, but the combination is expected to reduce wheel squeal occurrence more than a single resilient or damped wheel would.

SAB Wheel. The SAB wheel, illustrated in Figure 7-6, provides greater vertical compliance than the Bochum wheel, without sacrificing lateral stiffness. The SAB wheel is used on a number of light rail systems, including SEPTA, MBTA, and the San Jose LRT.

7.8.2 Noise Reduction Effectiveness

Comprehensive measurements of noise reduction effectiveness of resilient wheels were made in 1972 at BART during the Prototype Car 107 tests (21), in 1979 at SEPTA (22), and in 1982 at the MBTA Green Line (23). Additional tests have been conducted by the London Transport (24). These data are discussed below with respect to tangent and curved track.

7.8.2.1 Tangent Track Performance

Tests conducted at SEPTA indicate that resilient wheels are largely ineffective in reducing running noise on tangent

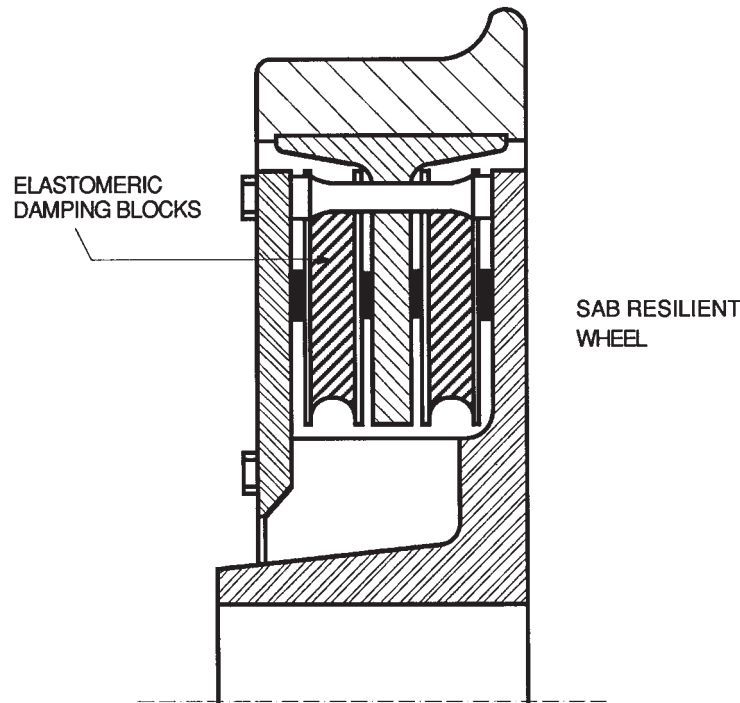

FIGURE 7-6 SAB RESILIENT WHEEL

track (contrary to some manufacturers' claims) (25). The wayside noise reductions were 0 to 2 dB on tangent track with resilient wheels relative to solid wheels. The data obtained at BART indicate that the noise reduction on tangent ballast-and-tie track with smooth ground rail was on the order of 0 to 1 dBA, similar to the results obtained at SEPTA. The interior noise was described subjectively as lower with the Penn Bochum wheel than with the standard wheel. At the MBTA, test data indicate no significant difference between standard solid and resilient Acousta-Flex and SAB wheels at the Huntington Avenue Station for train speeds on the order of 25 to 30 mph.

7.8.2.2 Curved Track Performance

A comparison of squeal noise reductions achieved with the Penn Bochum, Acousta-Flex, and SAB wheels is presented in Table 7-1 for tests conducted at BART, SEPTA, and MBTA. The Penn Bochum, Acousta Flex, and SAB wheels are all very effective in reducing wheel squeal and howl on smooth ground rail at curves. The BART Car 107 tests indicate reduction or elimination of 500 Hz wheel/rail howl at curves with ground rail. Measured reductions of car interior noise were 12 to 18 dBA at a 540-ft radius curve for the Penn Bochum wheel on ground rail, with similar noise reductions outside the vehicle. The Acousta Flex wheel provided noise reductions of 0 to 2 dBA on unground rail

at the same curve. At a shorter 530-ft radius curve, the tests indicated car interior noise reductions of 3 dBA for the Penn Bochum on ground rail and 5 dBA reduction for the Acousta Flex on unground rail. At the squeal frequencies above 1,000 Hz, the noise reductions were greater, as shown in Table 7-2.

Examples of octave band noise levels obtained for BART Car 107 are provided in Figure 7-7. The peak at 500 Hz is due to low-frequency squeal or howl, believed to be caused by vibration of the tire in a transverse mode. The Bochum wheel was effective in eliminating the 500 Hz component. The AcoustaFlex wheel is less resilient than the Bochum and was ineffective on unground rail and marginally effective on ground rail in reducing the peak at 500 Hz.

The SEPTA tests indicate that the Bochum wheel was the most effective resilient wheel in reducing wheel squeal at frequencies above 1,000 Hz, followed by the Acousta Flex and then by the SAB. This squeal mode is believed to be caused by bending vibration of the tire, with little strain energy storage in the web or axle, a mode that may be contrasted with the vibration mode at 500 Hz. The SAB wheel was less effective than the former two because it had a lower loss factor than those of either the Penn Bochum or Acousta Flex wheels.

Wayside curving A-weighted noise reductions were 8 to 10 dBA for the Penn Bochum and Acousta Flex wheels and 3 to 4 dBA for the SAB wheel. At the squeal frequencies,

TABLE 7-1 NOISE REDUCTION EFFECTIVENESS OF RESILIENT WHEELS AT CURVES - NOISE LEVELS WITH RESILIENT WHEELS RELATIVE TO THOSE WITHOUT

System	Track Type	Wheel Type	Relative Noise Level		
			Wayside	Interior	At Squeal Frequency
			dBA	dBA	dB
SEPTA	All Tangent Track, Welded and Jointed	Acousta Flex	0 to -1	0 to -2	--
		Penn Bochum	0 to -1	0 to -2	--
		SAB	0 to -1	0 to -2	--
	Curve Track	Acousta Flex	-8 to -10	-1 to -2	-5 to -30
		Penn Bochum	-8 to -10	-1 to -2	-20 to -30
		SAB	-3 to -4	0 to -1	0 to -30
BART	Ballast & Tie, Continuous welded Rail	Acousta Flex	0 to -2	0 to -2	--
		Penn Bochum	0 to -2	0 to -2	--
	Curve, DF Track in subway	Acousta Flex	-3 to -9	-1 to -5	-3 to -25
		Penn Bochum	-9 to -16	-8 to -18	-15 to -30
LONDON TRANSPORT	Tunnel	Penn Bochum	--	-5	--
		SAB	--	-3	--
MBTA	Lechmere Station Loops	Acousta Flex	-13	-11	--
		SAB	-14	-17	--

typically above 1,000 Hz, the Penn Bochum produced a 20 to 30 dBA noise reduction, followed by the Acousta Flex with a 5 to 30 dB reduction, and then by the SAB with a 0 to 30 dB reduction. The reduction by 30 dB at the squeal frequency is due to elimination of the squeal. London Transport reports a total noise reduction of 3 and 5 dBA at curved track with the use of the Penn Bochum and SAB wheels, respectively.

Recent measurements were conducted at Sacramento RTD and at the Los Angeles Blue Line (26), both with Bochum resilient wheels and onboard lubrication with HPF and LCF dry-stick lubricant. The curve at Sacramento is embedded ballast-and-tie track, with concrete pavement between the rails. At Los Angeles, specifically Long Beach, the track is resiliently supported with an elastomer pavement between the rails and at either side. The results at Sacramento indicate that squeal occurs at the 82-ft radius curves, while at the 100-ft radius curve, squeal occurrence is very low and limited to a pure tone at about 500 Hz. At the 90- and 100-ft radius curves at the Los Angeles Blue Line, squeal is nonexistent.

How much of the squeal noise control at the Blue Line curves is due to the Bochum wheel and how much is due to the HPF and LCF onboard lubrication is not known, and squeal is observable at larger radius ballast-and-tie track curves in the Blue Line maintenance yard. The combination of resilient wheels with onboard lubrication, $\frac{1}{4}$ in. wider wheel gauge, $\frac{1}{2}$ -in. track gauge widening at curves, 115-lb/yd rail, elastomer grade crossing, and resilient rail support appears to be effective for controlling squeal.

Portland Tri-Met vehicles use resilient Bochum wheels on monomotor trucks. Measurements were conducted at Tri-Met 82-ft radius embedded track curves at a time when oil drop lubricators were used on two cars of the fleet. The embedded track consisted of girder rail embedded in a solid urethane elastomer, poured in a concrete trough. Wheel squeal with the Bochum wheels was not observed during periods of high humidity and dampness of the rail, but was significant during dry periods. The squeal at Tri-Met was not very different from that observed at the Sacramento 82-ft radius curve. At the larger radius ballast-and-tie curves, the squeal was also significant.

In summary, the effectiveness of resilient wheels in controlling squeal is mixed at short radius curves. However, squeal appears to be well controlled on curves of 100 ft or larger radius by a combination of resilient wheels, onboard tread lubrication with a friction enhancer, tighter gauge, and rubberized grade crossing.

7.8.3 Site-Specific Conditions

Discussed below are certain site-specific limitations that may apply to selection of resilient wheels.

7.8.3.1 Tread Brakes

The measurements at SEPTA demonstrated that resilient wheels with elastomer springs are not entirely compatible with tread braked systems due to heat buildup caused by friction between the brake shoe and tread. Both the SAB

TABLE 7-2 SQUEAL NOISE REDUCTIONS OBSERVED FOR VISCO-ELASTICALLY DAMPED WHEELS AT SHORT RADIUS CURVES

TEST CONDITION				A-WEIGHTED LEVEL	OCTAVE BAND FREQUENCY - HZ		
Curve Radius	Speed	Location	Rail		500	1,000	2,000
feet	mph			dBA	dB	dB	dB
540	35	Interior	Unground	0	1	1	8
			Ground	7	7	5	12
		Exterior	Unground	0	0	0	10
			Ground	6	5	5	10
	18	Interior	Unground	2	2	2	7
			Ground	9	4	8	10
		Exterior	Unground	5	4	3	13
			Ground	4	-1	5	3
530	18	Interior	Unground	6	0	6	22
			Ground	0	1	0	-4
		Exterior	Unground	10	3	6	19
			Ground	-1	-2	-1	-2

Note: Negative values indicate higher noise levels.

and Penn Bochum wheels failed in this manner. Two of the elastomer blocks of one of the Penn Bochum wheels contained defects which were exacerbated by heat caused by exclusive use of the tread brakes after failure of the dynamic braking system. The SAB wheels on one of the axles suffered severe damage after application of the hand brake (ostensibly for extended periods of time) during revenue service. The Acousta Flex wheel was removed during testing due to bond failure, possibly caused by incomplete bonding during manufacture. The problems with the resilient wheels were discovered before any structural failure of the wheels.

There are several examples of the successful use of resilient wheels on vehicles with tread brakes. One is the original PCC streetcar, in use since the 1930s. Prior to 1974, London Transport evaluated SAB and Bochum wheels for several years of revenue service. The SAB wheels were run 367,000 km on transit cars with tread brakes, and 53,000 km of service were with a car with no dynamic braking. The Bochum wheels were operated for 212,000 km of revenue service with no problems caused by heat from braking (27).

7.8.3.2 Disc Brakes

BART, which uses disc brakes on all vehicles, ran Bochum resilient wheels on Car 104 for roughly 10 to 12 years, with one rebuild, and the Acousta Flex wheels on Car 107 for less time, without serious problems (28). There were some difficulties with shunts, which were solved by adding external cable shunts. Interestingly, the original Bochum

wheels tested in 1972 have been overhauled and are now in service on rehabilitated Car 596, the only car of the BART fleet of 500 or more cars with resilient wheels.

7.8.3.3 Truck Shock and Vibration Reduction

A perhaps very valuable ancillary benefit of resilient wheels is the reduction of truck shock and vibration, the reason for the development of the PCC resilient wheel. BART Cars 104 and 107, with resilient wheels, are believed to have experienced less truck maintenance problems than the other vehicles, though the information is entirely anecdotal and without corroboration with written record. BART has experienced significant failure rates during the early years of operation of cars fitted with rigid wheels, though car reliability with standard wheels is much improved and considered acceptable. At the very least, the survivability of Cars 104 and 107 appears to be unimpaired by the use of resilient wheels. Again, these observations are purely anecdotal and not supported by quantitative data.

7.8.3.4 Corrugation

The Cleveland LRT RTA reports (survey questionnaire) the occurrence of ripple corrugation at station stops with resilient wheels on light rail vehicles and no problems with solid steel wheels on the heavy rail system. (No wheel/rail noise problems are reported, however.)

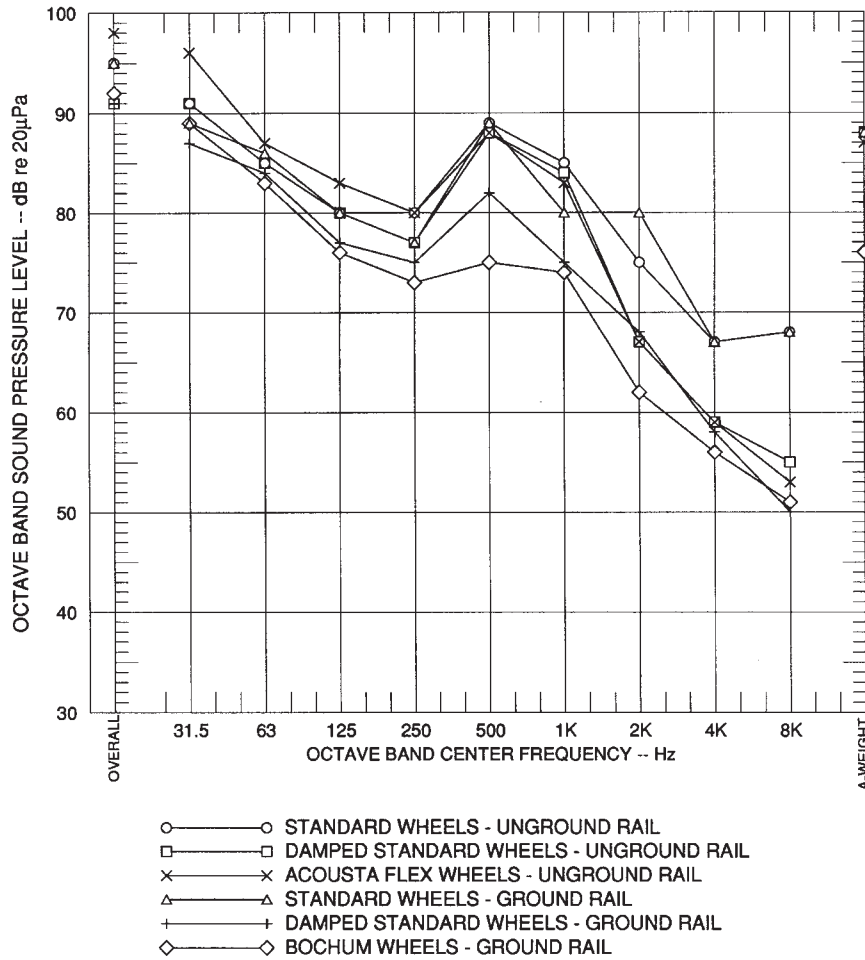

FIGURE 7-7 CAR INTERIOR NOISE LEVELS FOR BART PROTOTYPE CAR 107 IN BOX SUBWAY ON 540-FT RADIUS CURVE - 35 MPH

The Pittsburgh system is evidently experiencing corrugation at various sections of track and also uses the Bochum wheel. Part or all of the problem may be related to deferred rail grinding, which might otherwise control this problem.

There appears to be significant rail corrugation at certain light rail embedded tracks incorporating girder rail embedded in solid urethane elastomer. Examples include the Portland Tri-Met, where significant groundborne noise and vibration from corrugated embedded track has been observed (29), and the system at Calgary, Alberta. Both of these systems employ Bochum resilient wheels. Subsequent rail grinding appears to have alleviated this problem. Portland is designing new embedded tracks to have a lower rail support modulus than that of urethane elastomer embedded track, by employing resilient rail fasteners. How well the resilient embedded track works with the resilient wheels is not known yet, but rail corrugation appears to be under control at the Los Angeles Blue Line, which has a resilient rail support for the embedded track (30).

TTC received numerous complaints concerning ground vibration after introduction of the Canadian light rail vehicles with Bochum resilient wheels. TTC vigorously investigated the problem and decided to keep the Bochum wheel and control ground vibration with rail grinding and wheel truing (31). The problem was identified with high radial stiffness, and resilient wheels with lower radial stiffness evidently exhibited less tendency to become rough and generate ground vibration. However, TTC determined that wheel truing and maintaining rolling diameter tolerances for all wheels was sufficient to justify retaining the Bochum wheel (32).

7.8.4 Costs

The costs for Bochum wheels range between \$1,800 and \$3,000 per wheel, depending on size and type (33), and costs vary from procurement to procurement. The cost of a replacement tread is about \$1,000, delivered. Labor for tread replacement may also be about \$1,000 per

wheel, depending on local labor rates and shop practices. The tread replacement cost is driven by a need to remove the wheel from the vehicle. The new Bochum 84 wheel is designed to allow tread replacement in situ. Costs for the SAB and other resilient wheels have not been established.

There may be significant cost savings achieved with resilient wheels with respect to reduced truck maintenance resulting from reducing truck shock and vibration. The PCC resilient wheel was developed with this in mind.

7.9 DAMPED WHEELS

Damped wheels reduce noise by absorbing bending vibration energy stored in the tire and wheel web. Damped treatments come in a variety of configurations, the most economical of which is the ring damper, a frictional (or Coulomb) damper consisting of a steel ring let into the inner diameter of the wheel rim or tire. Other configurations include visco-elastic damping rings, vibration absorbers attached to the wheel rim, and constrained layer dampers attached to the rim. Most of these are effective in controlling wheel squeal at curves, but have little effect on wheel/rail noise on tangent track.

An advantage of the damped wheel relative to the resilient wheel is that wheel squeal can be controlled without concern over stability of the wheel. The tread of the resilient wheel tire can deflect relative to the wheel center, which may not be acceptable for certain types of track. Stuttgart is evidently replacing resilient wheels with rigid wheels fitted with vibration absorbers.

Vibration absorbers attached to the tire and designed to absorb vibration energy over a range of frequencies from 400 Hz to 5,000 Hz can be effective in reducing wheel squeal. Usually, high-frequency squeal at frequencies above about 1,000 Hz is most significant. However, the low-frequency transverse vibration of the tire at roughly 500 to 1,000 Hz might be associated with corrugation formation, and damping of these vibration modes might reduce rail corrugation rates and associated noise.

A study of the vibration modes of the wheel will aid in the identification of appropriate damping treatments. Constrained layer dampers must be applied at locations involving maximum bending strain. Vibration absorbers, on the other hand, should be mounted at locations of maximum vibration velocity. For transverse bending of a wheel, maximum bending strain and velocity occur at the tire. Significant bending of the wheel center may also be involved, in which case a constrained layer damping treatment would be effective if applied to the web of the wheel, but a vibration absorber would not be effective if mounted at the web, or worse, at the hub.

For radial vibration deformation of the wheel, constrained layer damping treatments would be ineffective if applied to

the wheel center, but a vibration absorber applied to the rim with effective axis in the radial direction would be effective. A vibration absorber capable of absorbing both radial and transverse vibration at the tire appears to be a very attractive approach to controlling both radial and transverse modes of wheel vibration.

7.9.1 Products

Commercially available damping systems include the following.

Krupp Tuned Vibration Absorbers. The Krupp tuned vibration absorber wheel has been offered by Krupp-Stahl AG of Germany since the late 1970s. The design, illustrated in Figure 7-8, consists of multiple stainless steel dampers bolted to a steel rim, which, in turn, is bolted to the rim or tire of the wheel. A variant of the design tested at the MTA NYCT was bolted to the field side of the tire with T-slots machined into the tire. Other variations of mounting have been developed and investigated. The damper assembly includes variable thickness damping blades, each tuned to specific modal frequencies of the wheel. The weight of the damper assembly is 44 lb, but some material is removed from existing tread for mounting, limiting the overall weight increase to less than 10 lb. At the MTA NYCT, 40 lb of material were removed from the wheel for testing, giving a net weight increase of about 4 lb (34).

Adtranz. Wheel vibration absorbers are provided by MAN/GHH and have been distributed by AEG Transportation (now Adtranz) for Deutsche Aerospace. The manufacturer's literature indicates that these units are very effective in reducing noise at resonance peaks above 500 Hz. AEG

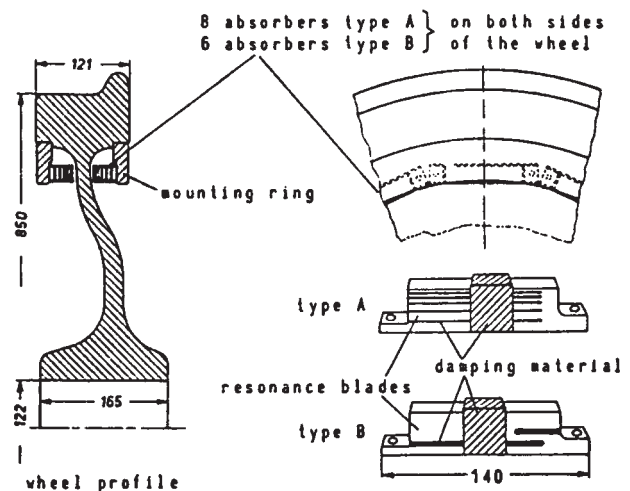

FIGURE 7-8 KRUPP TUNED VIBRATION ABSORBER

has marketed a vibration absorber called a broad band wheel noise vibration absorber, developed by Innovative Noise Control Technologies (INCT). Both Adtranz and INCT are part of Deutsche Aerospace AG (DASA) and Daimler Benz Group.

The vibration absorber is a fin-type absorber with multiple bending elements mounted on the tire and extending radially inward toward the center of the hub. Adtranz indicates that the absorber design has been in use in Europe since 1980, including by the ICE. Currently, Adtranz is offering a block vibration absorber (referred to as VICON) which is compact and lightweight and may be tuned to wheel squeal frequencies. Tests conducted by Adtranz at the WMATA Metro indicate that these block absorbers are effective in reducing wheel squeal at 250-ft radius curves.

Bochum Composite Resilient and Damped Wheel. VSG, through Penn Machine, provides a resilient Bochum wheel with vibration absorbers attached to the tire to augment the squeal reduction effectiveness of the Bochum resilient wheel. The damper system consists of leaf springs and is applied to the Bochum 54 and Bochum 86 wheels. As discussed above, the Bochum wheel does not completely eliminate wheel squeal at short radius curves, and addition of properly tuned vibration absorbers to the tire would be expected to significantly reduce remaining squeal noise.

Ring Damped Wheels. A generic ring damped wheel consists of a mild steel ring let into the inner surface of the steel

rim, as illustrated in Figure 7-9. This configuration is in use at the Chicago CTA and is effective in controlling wheel squeal (35). The damping arises from Coulomb friction between the ring and the confining groove. No drilling and tapping are required to mount the damper.

Visco-Elastic Ring Damped Wheel. A variant of the generic ring damped wheel is the Soundcoat Co. ring damped wheel. The ring damper consists of a 0.625-in.-diameter steel rod coated with Soundcoat DYAD damping treatment. The ring is let into the inner diameter surface of the steel tire and bonded in place. At New York, the ring was installed in a standard MTA NYCT wheel with a groove cut for the purpose on the field side. An advantage of the visco-elastic ring damped wheel over the generic Coulomb ring damper is that damping action will not be impeded by contamination between the ring and tire or freezing due to corrosion. The visco-elastic ring damper, dependent on bending of the tire tread for effectiveness, would not effectively control transverse rotational rigid vibration of the tire.

Sumitomo Ring Damper. The Sumitomo ring damper consists of a damping layer bonded between two concentric steel rings. The assembly is force-fitted to the interior surface of the wheel rim at the field side, positively retained by four screws. This type of damper would be most effective in controlling bending vibration (squeal above 1,000 Hz) of the tire and ineffective in controlling rigid transverse rotational vibration of the tire.

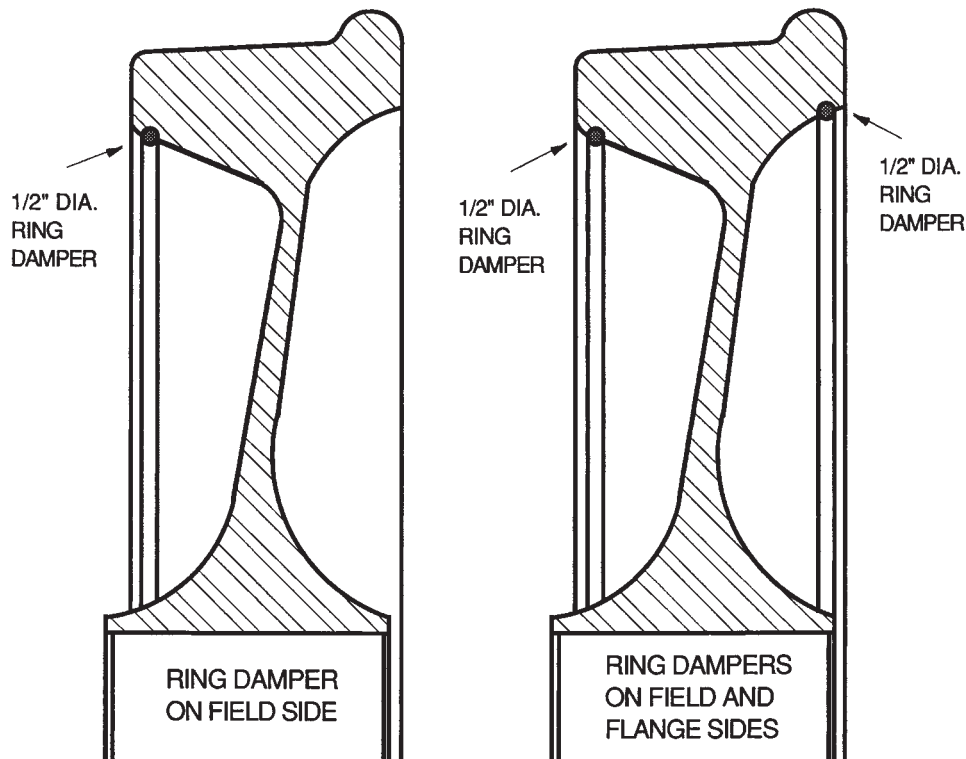
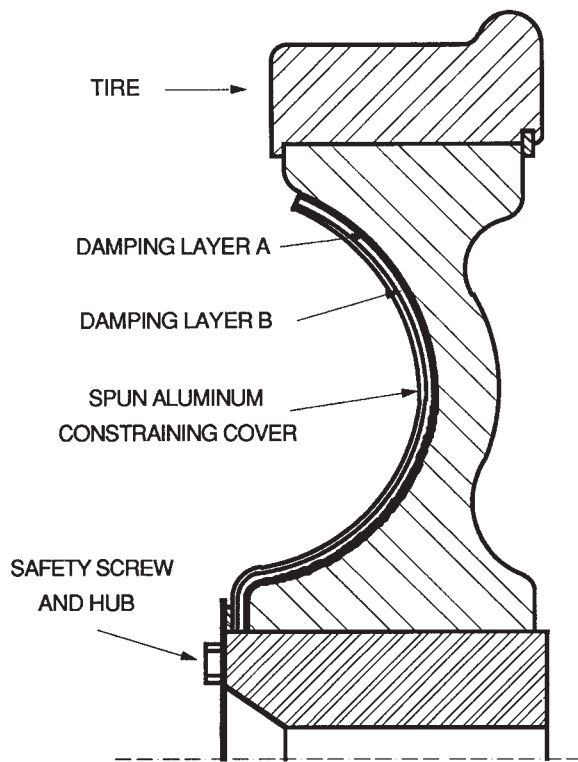

FIGURE 7-9 RING DAMPED WHEELS

Soundcoat Constrained Layer Damped Wheels. The Soundcoat Co. provides a constrained layer damper consisting of a layer of DYAD damping treatment adhered to the side of the rim of the wheel and constrained with a steel angle rolled into a ring, with positive mechanical retention. This configuration has evidently been implemented at the Paris Metro and was tested at the MTA NYCT. The damper would be effective in controlling bending vibration of the tire and ineffective in controlling rigid transverse rotational vibration of the tire.

Wheel Center Constrained Layer Damper. A second type of constrained layer damper, not commercially available, consists of a layer of Soundcoat visco-elastic damping treatment constrained between a spun aluminum dish and the gauge side of an aluminum centered wheel. The design (Figure 7-10) was evaluated at BART (36). The design is included in the report because it represents one of the earliest designs evaluated on a modern U.S. transit system.

Constrained Layer Acoustic Absorber (Klockner-Werke). The Acoustic Absorber consists of a series of concentric circular 1-mm-thick sheet metal annular discs separated by 2 mm of visco-elastic damping material, or thermoplastic. When the assembly is bolted to the wheel, metal-to-metal con-



BART STANDARD WHEEL WITH
CONSTRAINED DAMPING LAYERS

FIGURE 7-10 BART CONSTRAINED LAYER DAMPER
FOR WHEEL CENTER

tact is avoided. The absorbers are manufactured by Klockner-Werke AG. No performance data have been obtained.

7.9.2 Noise Reduction Effectiveness

The noise reductions of various damped wheels were measured at BART on Prototype Car 107 (37), at SEPTA (38), and at MTA NYCT (39). The BART tests involved measurement of the noise reduction performance of a dish-shaped constrained layer damper on the BART Prototype Car 107, and the SEPTA tests included a measurement of the generic ring damper. The tests at the MTA NYCT included the (1) generic ring damper, (2) Soundcoat visco-elastic ring damper, (3) Sumitomo visco-elastic ring damper, (4) Soundcoat constrained layer damper, and (5) the Krupp tuned vibration absorber.

The description of squeal noise reduction performance is complicated by the intermittent nature of wheel squeal. Squeal occurrence is affected by humidity, contaminants, lubrication, turning radius, and so forth. When squeal does occur, it may reach levels in excess of 100 dBA at perhaps 25 ft from the vehicle, and the maximum level may vary over a range of 10 dB or more. With damping, wheel squeal noise is usually reduced, and there is usually greater uniformity of passby noise levels.

Ranges of observed A-weighted noise reductions for tangent and curved track are presented in Table 7-3 for most of the damped wheels identified above. The levels are based on the worst-case differences between maximum and minimum noise levels observed for the damped wheel and the comparable undamped wheel. Thus, the ranges are based on the minimum as well as maximum observed noise for the damped wheels and thus are exaggerated to some extent. The best indicator of performance is whether the squeal is eliminated, which is difficult to determine from the literature unless noted therein or indicated by inspection of narrow band or 1/3-octave band spectra.

7.9.2.1 Products

BART Constrained Layer Damping Dish. The viscous damping plate, described in Figure 7-10, was evaluated on the BART Prototype Car 107. The results indicated no significant noise reduction on tangent welded track. On curved track, the results were mixed. At a 540-ft radius curve, the squeal noise reduction at the important 500 Hz octave relative to the standard wheel was insignificant for unground rail and about 7 or 8 dB on ground rail. At higher frequencies, the noise reduction was about 10 dB in the 1,000 and 2,000 Hz octaves. A-weighted noise reductions were on the order of 4 to 6 dB, limited by the performance at 500 Hz. A summary of the observed noise reductions is presented in Table 7-2. On unground rail, the peak in the noise spectra was at about 500 Hz. After rail grinding, the peak in the squeal frequency shifted upward to 1,000 to 2,000 Hz, where the damping

treatment was more effective. The reason for the frequency shift of squeal noise was not determined, nor was the rail grinding procedure described in the report.

There are certain attractive features of the dish-shaped visco-elastic constrained layer damping treatment for the wheel center. The treatment may be applied to the interior side of the wheel, allowing inspection from the field side for wheel web flaws. A second feature is that no machining is required of the tire or tread to accommodate a constrained layer dish damper. Thus, there is no stress concentration resulting from modification of the tire or machining costs for retrofit.

The dish-shaped dampers do not appear to be as effective in reducing squeal noise as the ring dampers, either visco-elastic or Coulomb type, perhaps because the mode shape associated with squeal noise primarily involves distortion of the tire or tread, as opposed to bending of the wheel center. That is, most of the strain energy associated with wheel squeal is in the tire. Finally, the dish damper at BART was not as effective as the Bochum resilient wheel in reducing curving noise.

Soundcoat Constrained Layer Damped Wheel. The Soundcoat constrained layer damped wheel was evaluated at the MTA NYCT and found to be effective at all frequencies. The damping treatment was applied to a standard MTA NYCT 34-in.-diameter wheel for testing. Wheel squeal was virtually eliminated, as indicated by the lack of discrete frequency squeal components in passby noise spectra, relative to the standard MTA NYCT wheel. After 17 months of service, squeal at 2,325 and 4,175 Hz was obtained. Maximum A-weighted noise levels were 82 to 86 dBA after 17 months, compared with 81 to 83 dBA when new. Degradation may be attributed to wear of the rail and wheel, which may affect tribological properties and wheel and rail contours. That is, wear of the tire tread may reduce or eliminate tread taper, thus reducing or eliminating rolling radius differential and increasing slip between the tire and rail. Another possibility is that wheel flange and/or rail gauge face wear allowed an increase in crabbing angle and thus lateral slip.

Visco-Elastic Ring Damper. The Soundcoat and Sumitomo visco-elastic ring dampers were tested at the MTA NYCT and found to be as or more effective than the Soundcoat constrained layer damped wheel. Both of these dampers place damping treatment directly against the tire, where it is most effective in absorbing bending vibration of the tire. The narrow band spectra for selected samples of noise obtained during curve negotiation indicate little evidence of wheel squeal components, though the resonant response of the associated vibration mode can be observed.

Generic Ring Damped (Coulomb) Wheels. The noise reduction effectiveness of ring damped wheels was evaluated at SEPTA and at the Chicago CTA (40, 41). Tests at SEPTA indicate that the ring damped wheels exhibit a damping factor comparable to that of the SAB wheel (which is a factor of 8 to 10 less than those of the Bochum 54 and Acousta Flex

wheels) at frequencies above about 1,400 Hz. Above 1,400 Hz, squeal noise was reduced, and below 1,400 Hz, little noise reduction was obtained, possibly because there was little bending strain in the tire at these lower frequencies. After several months of service, the rings became impacted or frozen in their grooves due to corrosion and foreign material such as brake and steel dust. When frozen in their grooves, the rings lose their frictional damping characteristics.

Wheel squeal noise reductions on the order of 9 to 11 dB were observed for ring dampers that were not frozen in place. With the rings frozen, the noise reduction was on the order of 3 and 5 dB for ground and unground track, respectively. The noise reduction effectiveness of ring damped wheels on tangent track at SEPTA was on the order of 2.5 dBA or less, with the maximum reductions on worn or jointed track. For continuous welded rail, the noise reductions were not significant, as has been observed at other systems. The greatest tangent track noise reduction was observed in the car interior, while wayside noise levels were reduced less than 1.6 dB.

At the Chicago CTA, interior noise reductions of 1 to 15 dB and 5 to 20 dB were observed for squeal noise components at curved track. At tangent track, running noise reductions for welded track were limited to 2 dB (42). Other tests indicated a 2 dB noise reduction on tangent jointed track and 0 dB on tangent welded track, consistent with the results obtained for the SEPTA system (43).

Krupp Tuned Vibration Absorber. The Krupp tuned vibration absorber is illustrated in Figure 7-8. Wheel squeal noise was inhibited by the Krupp tuned vibration absorber during tests at the MTA NYCT. Further, the vibration modes associated with wheel squeal components appear to be completely eliminated. However, tests after 17 months of service were inconclusive, because the Krupp vibration absorber was tested on a vehicle with another vehicle with standard wheels, which produced squeal. The data suggest, however, that squeal is also absent from the passby noise for the vehicle equipped with the Krupp tuned vibration absorber.

Adtranz (AEG DASA & GHH/MNN) Vibration Absorber. Manufacturer's data provided by Adtranz indicate substantial reduction of noise by GHH/MNN vibration absorbers at discrete frequencies above 500 Hz. The noise reduction applies to squeal at curves, and the manufacturer indicates a 20 to 30 dBA noise reduction. The wheels are about 4% heavier with the absorbers than without. AEG reports that the AEG DASA vibration absorbers reduce wheel squeal noise at the 250-ft radius curve at the WMATA West Falls Church maintenance yard (44). The newer block vibration absorbers currently promoted by Adtranz have been tested at WMATA with significant reduction of squeal noise.

Constrained Layer Acoustic Absorber (Klockner-Werke). The Klockner-Werke Acoustic Absorber was

TABLE 7-3 NOISE REDUCTION EFFECTIVENESS OF VARIOUS DAMPED WHEELS

Damper	Test Location	Damper Condition	Track Type	Noise Reduction	
				A-Weighted	Squeal Frequency
				dBA	dB
Generic Ring Damper	SEPTA	?	Tangent Welded & Jointed	0 to 1	--
		New	Curve	2 to 11	10 to 25
		Seized	Curve	0 to 5	0 to 5
	CTA	?	Tangent Jointed	1 to 2	--
			Tangent Welded	0	--
			Curve	3 to 8	5 to 20
	NYCTA	New	Curve	21	24
London Transport	?	Tangent	0	--	
Constrained Layer Dish Damper	BART	New	Tangent Welded Ballast & Tie	0	--
			Curve	10	25
The Soundcoat Co. Visco-Elastic Ring Damper	NYCTA	New	Curve	8 to 25	Eliminated
		After 17 months	Curve	11 to 22	Eliminated
The Soundcoat Co. Constrained Layer Damped Wheel	NYCTA	New	Curve	7 to 24	Eliminated
		17 Months	Curve	11 to 18	--
The Sumitomo Constrained Layer Damping Ring	NYCTA	New	Curve	9 to 27	Eliminated
		17 Months	Curve	13 to 20	--
Krupp Tuned Vibration Absorber	NYCTA	New	Curve	8 to 25	Eliminated
		17 Months	Curve	12 to 19	--

tested by the Deutsche Bundesbahn on 250 km/hr intercity coaches (45). The results of the tests indicate that the noise reduction produced by the absorber is about 5 dB for trued wheels and ground rail at tangent track when integrated over a frequency range of about 600 to 3,800 Hz. The authors indicate that the result would be similar for A-weighted noise levels. The wheel/rail roar noise reduction performance of the absorber on tangent track is one of the highest reported. At frequencies above 1,000 Hz, noise reductions on the order of 10 dB or more were obtained. However, the noise reduction provided by the absorber was small or nonexistent at frequencies below 1,000 Hz, where much of transit wheel/rail noise at tangent track occurs. Systems with tangent track A-weighted noise dominated by noise energy at frequencies less than 1,000 Hz might not benefit from such an absorber, similar to the result obtained for the BART constrained layer dish absorber. Finally, the test data indicate that the source height for the wheels with absorber is close to the top of rail, suggesting that the dominant source of noise at frequencies above 1,000 Hz may be the rail when the resonances of the wheel are effectively damped.

7.9.2.2 Site-Specific Conditions

Temperature. Vibration absorbers, dynamic absorbers, or dampers which absorb vibration energy with a visco-elastic elastomer are affected by temperature. However, no data have been supplied concerning the performance of vibration absorbers at low or very low temperature. Fortunately, the windows of residential and commercial buildings are likely to be closed during cold periods, so that the temperature dependence of the absorbers may not be particularly important. Pedestrian traffic would still be exposed to squeal. In subways, temperatures are more uniform, so that vibration absorber performance may not be lessened during the winter. Visco-elastic damping materials may be optimized for various temperature ranges. Before selecting a vibration absorber for application in cold climates, the manufacturer should provide data concerning cold weather performance.

Dust and Debris—Freezing. Squeal noise reduction effectiveness of SEPTA ring dampers was lost as a result of dirt and other material freezing the damping ring in the retaining groove. The Chicago CTA reports no such problem, however.

Wheel Tire Design. Wheel tread designs may be such that mounting of damper assemblies to the tread may compromise the fatigue resistance of the tread. Care must be taken in selecting and mounting damper assemblies. Usually, a stress analysis should be performed, and the manufacturer of the damping treatment should warrant the product against damage to the tire resulting from mounting.

Outboard Disc Brakes. Outboard disc brakes may interfere with mounting of damper assemblies to the exterior of the wheel. AEG mounted the DASA absorbers on the inboard side of the wheel to avoid this problem during tests at WMATA. However, they would be less easily inspected on the inboard side. Wheel vibration absorbers appear to be mounted on the flange side of the wheel in most applications, which may help protect the absorber from damage by track-side appurtenances and equipment.

7.9.2.3 Costs

The approximate cost for tuned vibration absorbers is expected to range between \$500 and \$1,000 per wheel. In sufficient quantities, these costs might be reduced further. Preparation of the wheels and mounting of the absorbers may cost an additional \$1,000 per wheel. However, assuming that the mounting holes can be drilled and tapped in about 4 hours of shop time, the mounting cost, at \$75 per hour, may be on the order of \$300. Both procurement and mounting costs must be considered.

The various constrained layer damping treatments tested at the MTA NYCT cost about \$1,000 to \$1,200 per wheel, including mounting, at the time of the tests in the 1980s. Applying a producer price index of 1.5 would make these costs closer to \$1,500 to \$1,800 per wheel. However, these costs should be reduced considerably for large quantities, and costs of the order of those for block vibration absorbers would not be unexpected.

The ring damper costs about \$35 per wheel. The groove may be machined into the tire during manufacturing, so that the cost for providing the groove may be minimal.

No cost data were obtained from operating U.S. transit systems, due to lack of application, except for the ring dampers.

7.10 UNDERCAR ABSORPTION

Undercar absorption was evaluated on the BART Prototype Car 107 in 1970 (46). Car interior noise data collected over the X-End truck (between the doors) at 60 and 80 mph on ballast-and-tie tangent track with ground rail indicate a 3 to 4 dB noise reduction with either standard or damped wheels. Maximum effectiveness was obtained at the 500 Hz and higher octave bands. These results are particularly encouraging because the ballast already contributes substantial sound absorption. The undercar treatment was applied

over the trucks and consisted of 140 sq ft of Microacoustic duct liner of 1 in. thickness. Propulsion system noise is a dominant source of undercar noise on ballast-and-tie track for the BART vehicle on smooth ground continuous rail. Undercar sound absorption is expected to be effective in controlling noise between the underside of the vehicle floor and top of the truck.

Measurements of car interior noise at the 19th and 12th Street curves in the BART subway indicate 0 to 2 dBA noise reduction with the use of undercar absorption, including a reduction of squeal and howling noise by about 2 dB. The reduction is most significant in the 250 to 4,000 Hz octave bands. However, in the subway, most of the sound transmitted into the car interior is radiated outward from the vehicle truck area and reflected from the subway walls, and this sound energy would not be absorbed directly by the undercar sound absorption.

Wheel/rail noise that is radiated inward and upward and reflects from the underside of the vehicle will tend to find its way into the train tunnel annulus if it is not absorbed and then into the car interior, subject to transmission loss of the car body. Undercar sound absorption can remove this component, but would leave the noise radiated outward from the wheels and rail unabsorbed. Thus, no more than 1 or 2 dB noise reduction would be expected from undercar absorption over the truck area, as is supported by the data. Essentially the same result, about 3 dB reduction, is obtained with scale model predictions, though the results apply primarily to vehicles with substantial undercar equipment noise (47). To the extent that there is no significant absorption in subways with direct fixation track, provision of sound absorbing materials throughout the entire underside of the vehicle would, presumably, have a significant effect on reverberant sound levels in the subway.

Undercar absorption, which is relatively inexpensive, typically on the order of \$10 per sq ft for glass fiberboard, would also reduce undercar equipment noise and would be effective systemwide. Installed costs for absorption may be considerable, depending on the degree of protection and shaping required. Costs were estimated to be \$40 per sq ft in 1980 (48). More definitive cost data should be acquired before selecting undercar absorption as a treatment. Undercar absorption should be considered for obtaining additional noise control provided that interference with maintenance would not occur. Ideally, new car procurements should include undercar absorption provided by the manufacturer.

7.11 SKIRTS

Vehicle skirts have been proposed as a noise control treatment for both wheel/rail and traction system noise. Wheel/rail noise reductions at tangent track are expected to be minimal, because the rail and lower part of the wheel remain exposed. Earlier researchers have indicated that the noise reduction may be limited to 0 to 3 dB (49). Wheel

squeal should be reduced to the extent that squeal noise is radiated from the upper as well as lower portions of the wheel. The interior surfaces of the skirts should be treated with acoustical absorption to enhance their effectiveness.

Wheel skirts have been incorporated into the Denver light rail transit system vehicles supplied by Siemens Duewag, though no noise reduction data were obtained for this vehicle. Portland Tri-Met plans to use low-floor-height vehicles with vehicle skirts, and unofficial measurement data indicate that noise reductions attributed to the skirts are about 2 dB.

A detailed study of vehicle skirt noise reduction in combination with undercar absorption and absorptive barriers was undertaken with model experiments and applied to measured noise levels from PATCO trains (50). The results are applicable primarily to vehicles with substantial undercar equipment noise, such as from propulsion system fans and gear boxes. The results do not indicate that skirts would be effective for controlling wheel/rail noise. The results for vehicle skirts in combination with absorptive sound barriers located close to the vehicle, as on an aerial structure, suggest that reduction of wheel/rail noise might be substantial, due to the narrow path required for propagation of sound between the exterior skirt surface and absorptive surface of the wall. In this case, the noise reduction of the combined treatment was predicted to exceed the sum of the noise reductions for the individual treatments by 2 dB. The total noise reductions are expected to be in excess of 10 dB. Without barriers, however, the undercar equipment noise reduction for skirts is estimated to be 5 to 9 dBA for half and full skirts, respectively, with undercar absorption. Again, for wheel/rail noise, which is not shielded by the skirt, the noise reduction may be less than 3 dB.

Test results were reported for the Shinkansen high-speed trains fitted with skirts extended to within 150 mm of the top of rail and with some sound absorption applied to the interior surface of the skirts (51). Some noise reduction was obtained for sections of track without barriers, and no noise reductions were obtained by the extended skirts at sections of track with barriers, suggesting that the skirts have limited usefulness for wheel/rail noise control.

Site-specific limitations may include clearance problems for third rail systems and maintenance and inspection limitations. Retrofit may be limited due to interference with truck-mounted equipment.

Costs were roughly estimated in 1980 to be about \$12,000 per vehicle for two full-length skirts and undercar absorption (52). Assuming a doubling of producer prices, the current costs would be roughly \$24,000 today. However, skirts and absorption would likely be part of an overall vehicle procurement and thus might be supplied at considerably lower costs than based on estimates of 1980. For instance, the Denver light rail system uses Siemens-Duewag vehicles with skirts, and presumable cost data have been developed. The skirts supplied to the Portland low-floor-height vehicle evidently cost about \$5,000 per vehicle.

7.12 STEERABLE TRUCKS

Steerable trucks have been proposed as a measure for controlling wheel squeal at curves. The TTC Scarborough line and the Vancouver Skytrain employ steerable trucks manufactured by the UTDC. Steerable trucks have axles that are linked in such a way that the axles point toward the center of the curve during negotiation, which eliminates lateral creep due to the finite wheel base of the truck. Rigid axle systems require that some longitudinal slip must occur, unless the curve radius is large enough to allow a rolling radius differential to develop. In this case, the wheel tread must be tapered, and the contact patches must be offset to the low rail side with, perhaps, gauge widening to allow roll without slip. On trucks with cross-linked axles, the steering is affected by the interaction between the wheel and rail, which deforms the primary suspension sufficiently to steer the truck (self-steered). If the axles are linked to the car body, the car body provides the steering forces (force-steered), in which case the steering is accommodated by deformation of the primary suspension or by a pivot. A major advantage of steerable trucks is the reduced wheel and rail wear, reduced energy consumption, and possibly improved ride quality. Reduced wear might offset the initial costs of steerable trucks (53).

At short radius curves, corrugation due to stick-slip can still occur, leading to roughened wheels and thus wayside noise. Examples include the TTC Scarborough line, which experienced severe herringbone corrugation at very short radius curves. The problem was exacerbated by friction in the truck suspension which prevented complete steerability.

7.13 SOFT VERSUS STIFF PRIMARY SUSPENSIONS

Trucks with soft primary suspension systems appear to produce lower levels of noise than equivalent trucks with stiff suspensions. Reductions on the order of 3 to 5 dBA for wayside noise and 8 to 9 dBA for car interior noise under some conditions are reported for modified Chicago CTA 2000 series vehicles with soft journal bushing suspensions versus CTA 2200 series vehicles. (This might be due to better vibration isolation between the car body and truck components, rather than entirely due to reduction of airborne wheel/rail noise.) Typical interior noise reductions were 4 to 5 dBA for ballast-and-tie track in subways and were less with jointed track in subway and on aerial structures (54).

The reduction of interior noise with reduced primary suspension stiffness is understandable, due to reduced force transmissibility across the primary suspension. However, an explanation for the reduction of wayside noise is less obvious, particularly if one assumes that most of the A-weighted noise contribution is at frequencies above perhaps 125 Hz, well above the primary suspension resonance frequency. One possibility is that the truck with soft journal bushing suspensions was better able to position itself on the track, thus

reducing stick-slip- or spin-slip-generated rolling noise. Less squeal noise would be expected with soft primary suspensions relative to stiff suspensions, due to better alignment of the axle with curve radii. However, this requires softness in the longitudinal direction, as opposed to the vertical direction, to allow the axles to steer themselves, a condition which has some impact on ride quality and stability.

In contrast, BART has one of the stiffest primary suspension systems and one of the quietest transit vehicles when the wheels are well trued and the rail is ground smooth. Further, tests at BART indicate little noise reduction by softening the primary suspension (55).

7.14 ONBOARD LUBRICATION

Onboard lubrication is used to lubricate the wheel flanges and enhance friction and tractive characteristics of the tread and rail. Flange lubrication is generally a friction reducer, designed to reduce wear and frictional forces. The tread lubrication is generally a friction enhancer, designed to flatten the friction versus creep curve and reduce or eliminate stick-slip between the tread and rail head running surfaces.

7.14.1 Flange Lubrication

Flange lubricant can be either in solid form (stick), grease, or oil. Of the three, grease has been found to be most effective in reducing rail and wheel wear at railroads. Solid lubricants and greases have both been used for noise reduction. However, if not properly controlled, the grease lubricant can find its way onto the top of the rail, leading to wheel-slip and poor train braking. (Note: This is also the case with wayside lubricators.) Ensuring that only the curves are lubricated is also difficult (though not always necessary). Dry-stick lubrication has become popular at light rail transit systems such as the Los Angeles Blue Line and Sacramento RTD, and Portland Tri-Met is experimenting with onboard dry-stick lubrication as well. The Portland Tri-Met system has also employed oil dispenser lubricators on two of the vehicles to control wheel squeal.

Advantages of onboard lubrication include ability to inspect and install new lubricant in the shop. A key advantage is the potential for increased control of the lubricant dispensing process and the use of equipment not kept at isolated field locations but brought back into maintenance shop areas on a periodic basis. In addition, the vehicular-mounted systems permit maintenance and inspection to be carried out in more convenient central locations, such as in yards or shops.

In recent years, a great deal of attention has been focused on improving vehicle-mounted lubrication systems. Consequently, there have emerged three distinct types of vehicle-mounted lubrication systems:

- High-rail vehicle systems (grease only),
- Locomotive- or car-mounted systems (grease, oil, or stick),
- Dedicated lubricator car (grease only).

In general, for grease application, the benefits of the vehicle-mounted systems, to some extent, are similar for all three types of systems. In all cases, applying the lubricant from a moving vehicle results in a uniform distribution of lubricant along the track. The specific locations where the lubricant is to be applied can be controlled from onboard the vehicle through either manual controls or through automatic sensing systems (for curves). In addition, lubricant can be applied continuously along the right of way, through both tangents and curves, if desired. However, a proper amount of lubricant must be applied. This necessitates frequent applications by the various lubrication systems, depending on the type of system and the amount of lubricant applied.

Vehicle (car- and locomotive-mounted) lubricators apply a predetermined measure of lubricant (grease, oil, or solid) to the wheel flange as the vehicle moves along the track. This lubricant is then deposited onto the gauge face of the rail by the wheel flange. There is no requirement for the lubricant to be carried along the track by the wheel. In fact, the required properties of the lubricant used in this type of system are that the grease remains where it is deposited and does not carry. (Thus, the direct properties of the lubricant are different for vehicleborne and wayside lubricators.)

The primary benefits of vehicle-mounted lubricator systems are noise reduction, energy savings (fuel reduction), and wheel wear reduction. The ability to reduce rail wear, particularly on sharp curves, is much more limited with vehicle-mounted systems than with wayside lubricator systems, including those systems with curve sensors, which increase the lubricant output (oil or grease) on curves.

Vehicle-mounted lubricators encompass a broad range of systems, which can be further defined by the type of lubricant used: solid, oil, or grease. In the rail transit environment, car-mounted stick lubricators can be mounted on every car in the fleet.

7.14.2 Oil Drop and Spray Systems

Onboard lubrication includes systems which drop oil, spray water, and apply lubricants to the wheel flange and tread. Oil drop and water spray systems have been in use for some time, exemplified by the Portland Tri-Met system's use of oil drops to lubricate the wheels of two vehicles out of the entire fleet to control wheel squeal at short radius curves.

An onboard lubrication system that uses oil as the active lubricant is the REBS wheel flange lubrication system, consisting of an oil pressurization and feed system mounted directly on the truck. The compressed air from braking systems may be used for pressurization. Lubricant is delivered to the flange through a nozzle as an oil-enriched spray with a droplet size on the order of 0.4 mm, producing a film thickness of about 0.001 mm. The lubricant is described by the manufacturer as biologically degradable and nonpolluting. No noise reduction data have been obtained, though the product is reputed by the manufacturer to reduce noise (56).

7.14.3 Dry-Stick Lubricants

Perhaps the most interesting development in wheel/rail noise and wear control are low coefficient of friction (LCF) flange lubricants and high positive friction (HPF) tread friction modifiers. An excellent review of onboard lubrication has been presented by Kramer (57). These onboard dry-stick lubricants have received widespread application among light rail transit systems and have been subjected to substantial operational testing, with mixed results.

Friction modifiers are distinct from conventional lubrication products. The HPF friction modifier applied to the tread running surface is not intended to reduce friction, but to modify the slope of the friction versus creep curve and reduce or eliminate the negative damping associated with stick-slip vibration and, perhaps, periodic roll-slip or spin-slip behavior which may contribute to short pitch or “roaring rail” corrugation.

LCF lubricants are applied to the flange to control flange and gauge face wear and should not be confused with HPF products, even though both of these products may be applied in dry form and supplied by the same manufacturer. Both LCF and HPF are applied in combination by several light rail systems to the flange and wheel tread, respectively, to improve traction and perhaps reduce wheel squeal and rail corrugation.

7.14.3.1 Systems Using Dry-Stick Lubricants

Systems that have tested dry-stick lubricants include the following:

- WMATA
- Los Angeles Blue Line and Green Line
- Portland Tri-Met
- BART
- Pittsburgh
- Vancouver Skytrain
- PATH (planning to test)
- Sacramento RTD
- Denver.

Certain British, European, and Asian systems, including the following, have considered, experimented with, or are using dry lubricants (58):

Docklands Light Rail (U.K.)	RATP Paris Metro (France)
British Rail (U.K.)	ET Bilbao (Spain)
FEVE (Spain)	Helsinki Metro (Finland)
Renfe (Spain)	AKN Hamburg (Germany)
DSB (Copenhagen)	Reinsbahn Dusseldorf
VAG Nurnberg (Germany)	(Germany)
Rostock (Germany)	Singapore MRT
London Underground	(Singapore)
(U.K.)	

The success or acceptability of the dry lubricants is not known for all of the above systems.

7.14.3.2 Manufacturers

Manufacturers of onboard lubrication products include the following:

- E/M Corp.—Manufacturer of Glidemaster.
- Kelsan Lubrication—LCF, HPF and HPF II high positive friction, and VHPF very high positive friction dry-stick treatments.
- Phymet, Inc.—This treatment, named Micropoly, is described as a high-density, miroporous polyethylene, with 65% 40-weight gear oil by weight, with particles of Teflon and molydisulfide and other additives (59). A Phymet product has been applied by the Metro-Dade County system (60).
- KLS Lubriquip—Solid-stick wheel flange lubricant. This product was tested by WMATA and discontinued (61).
- A&K Railroad Material—Manufacturer of Abbalube flange lubricant.
- REBS—Wheel flange lubrication for rail-mounted vehicles.

The Association of American Railroads is experimenting with a permanent film lubrication for application to railroads. The permanent film would be porous and impregnated with lubricant. No reports or test data have been obtained.

7.14.3.3 Noise Reduction Effectiveness

There are two types of noise reduction addressed by dry-lubricant technology: (1) wheel squeal at curved track and (2) noise caused by “roaring rail” corrugation on tangent or moderately curved track.

7.14.3.3.1 Curved Track

Friction modifiers such as the Kelsan HPF, in combination with LCF stick treatments, may inhibit stick-slip motion at curves, thus inhibiting wheel squeal. To the extent that wheel squeal is eliminated, noise reductions on the order of 20 dBA may be obtained. The results would not be dissimilar to conventional lubrication with water, oil, or grease. In practice, the use of lubricants for noise reduction has met with significant variations in reported rates of success. Some of the reported benefits of using the higher friction dry lubricants are as follows:

St. Louis MetroLink. The St. Louis MetroLink employs graphite lubricator sticks for wheel flange lubrication. The sticks are supplied by Kelsan Lubricants Ltd. at a capital cost of \$25,000 (62). This would presumably be the LCF flange

lubricant. No significant wheel squeal is reported at curves. Some gauge widening is employed at curves, and the vehicles are by Siemens-Duewag with monomotor trucks and resilient Bochum wheels (63).

Sacramento Light Rail. Tests at the Sacramento Light Rail Academy Way train yard using both wayside and onboard noise measurements showed noise reductions with the combined use of an LCF and HPF lubricant applied to the flange and tread, respectively, of 5 to 28 dBA at curves. Figure 7-11 presents one such set of measurement data (64). In this case, the lubricants were supplied by Century Lubricating Oils. (Kelsan is now a supplier of these products.) All of the vehicles are lubricated with both LCF and HPF dry-stick lubricant, though only a single axle of the idling truck of each vehicle is so lubricated. The Sacramento RTD uses resilient Bochum 54 wheels.

Sacramento RTD indicates that before application of dry-stick lubrication, complaints concerning noise regularly occurred. After application, no or few noise complaints occurred. A major advantage of the HPF treatment is improved braking, and the Sacramento RTD is pleased with the lubricant. Additional 1/3-octave band test data collected by this author are presented in Figures 7-12 and 7-13 for 100- and 82-ft radius

curves, respectively, with two-car Sacramento RTD vehicles. These data indicate the statistical variation of squeal noise as well as the energy-averaged squeal noise level during curve negotiation and the total noise exposure level for 16 vehicles, which may be used in calculating day-night or L_{eq} sound levels.

The L_{eq} levels are most relevant. The curves were adjacent to one another and were constructed of the same track forms, though of different radii. The gauge faces of the rails are lubricated by hand daily with a nonflowing grease (SWEPCO 604). The results clearly show frequent occurrence of squeal at the 82-ft radius curve and only moderate occurrence of squeal at the 100-ft radius curve. Squeal at the 500- and 630-Hz third octave bands occurs at both curves. Only the 82-ft radius curve produced high levels of squeal at the 1,600-Hz third octave band. Inspection of the rail at the 82-ft radius curves revealed a spotty surface, with residue presumably left by the friction modifier. The rail at the 100-ft radius curve was smoothly polished (65).

WMATA. Tests on a 300-ft radius curve at the New Carrollton yard showed wayside noise level reductions of 16 to 17 dBA between dry and lubricated (stick lube) conditions. The results are presented in Table 7-4. WMATA tested the

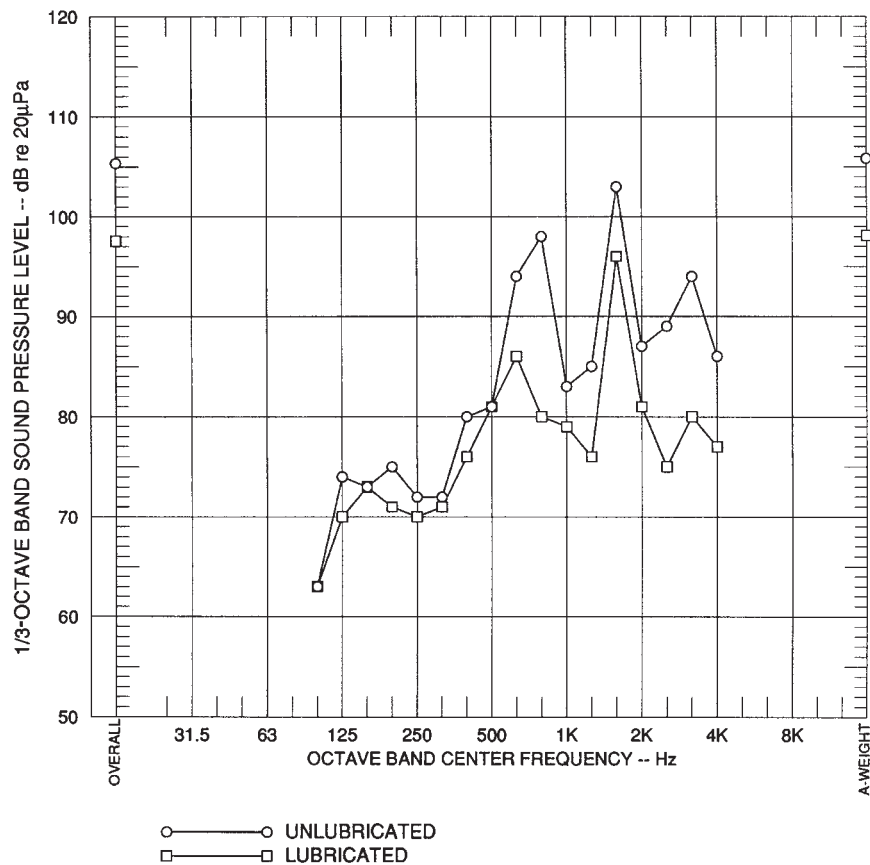

FIGURE 7-11 WHEEL SQUEAL MAXIMUM NOISE LEVELS AT SACRAMENTO RTD LIGHT RAIL SYSTEM WITH AND WITHOUT HIGH POSITIVE FRICTION LUBRICANT

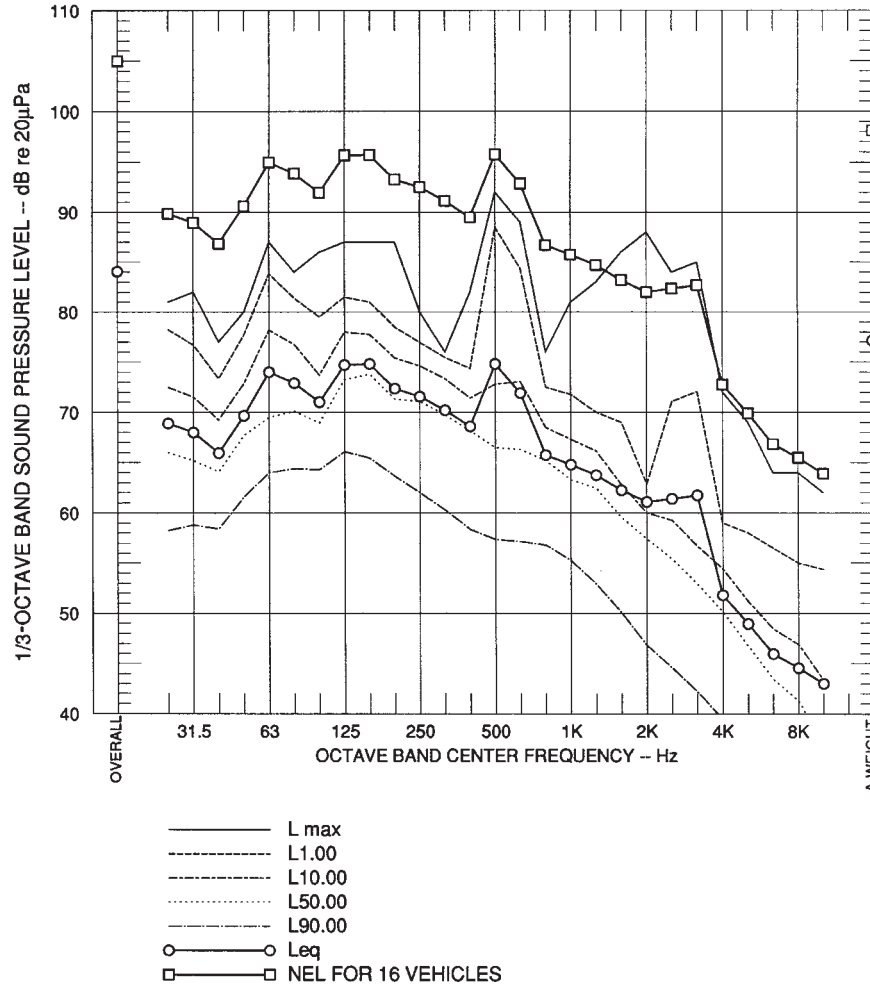

FIGURE 7-12 CURVING NOISE AT SACRAMENTO RTD, 23 FT INSIDE OF 100-FT RADIUS CURVE - TRAINS AT 7 MPH

Century Oils LCF Series (now distributed by Kelsan Lubrication) and KLS Lubriquip solid-stick flange treatments and found that the mounting brackets produced rattles and that the materials produced a squeal noise (66). Followup conversation with WMATA indicated that the noise reduction was moderate, but the cost was prohibitive, and, therefore, WMATA discontinued evaluation of the materials.

Portland Tri-Met. Portland Tri-Met is experimenting with combined Kelsan LCF flange lubricant and Kelsan HPF applied to the flange and tread surfaces of Bochum wheels on the center idling trucks of the entire fleet of articulated light rail transit vehicles. The lubricants were applied in late summer and early fall of 1994. No noticeable wheel squeal noise reductions were observed at short radius (82-ft) curves, nor have any noise reductions been observed at tangent track sections during the period in which the lubricators were installed. However, the weather was wet during the observation period. Tri-Met reinstalled the lubrication systems on all vehicles and had plans to conduct noise reduction tests dur-

ing the summer of 1996. Tri-Met has indicated that the wheel flanges are more polished than before treatment.

Los Angeles Blue Line. The Los Angeles Blue Line has Kelsan LCF and Kelsan HPF dry-stick lubricators applied to the flanges and treads, respectively, on each driven truck of each of the light rail vehicles. The Los Angeles MTA indicates that there is a lack of wheel squeal at curves, which include 90- and 100-ft radius curves in embedded track. The Los Angeles Blue Line embedded track consists of 115-lb/yd rail in resilient rail supports and has Bochum resilient wheels. The wheel flange gauge is wider than standard, and 1/2-in. gauge widening is employed at embedded track curves.

Observations by this author indicate that the short radius curves in Long Beach are smoothly polished and that there is a complete absence of squeal. However, squeal was observed at ballast-and-tie curved track in the Blue Line shops, which experiences less traffic than the embedded curves, but should be lubricated to the same degree on a per vehicle passage basis.

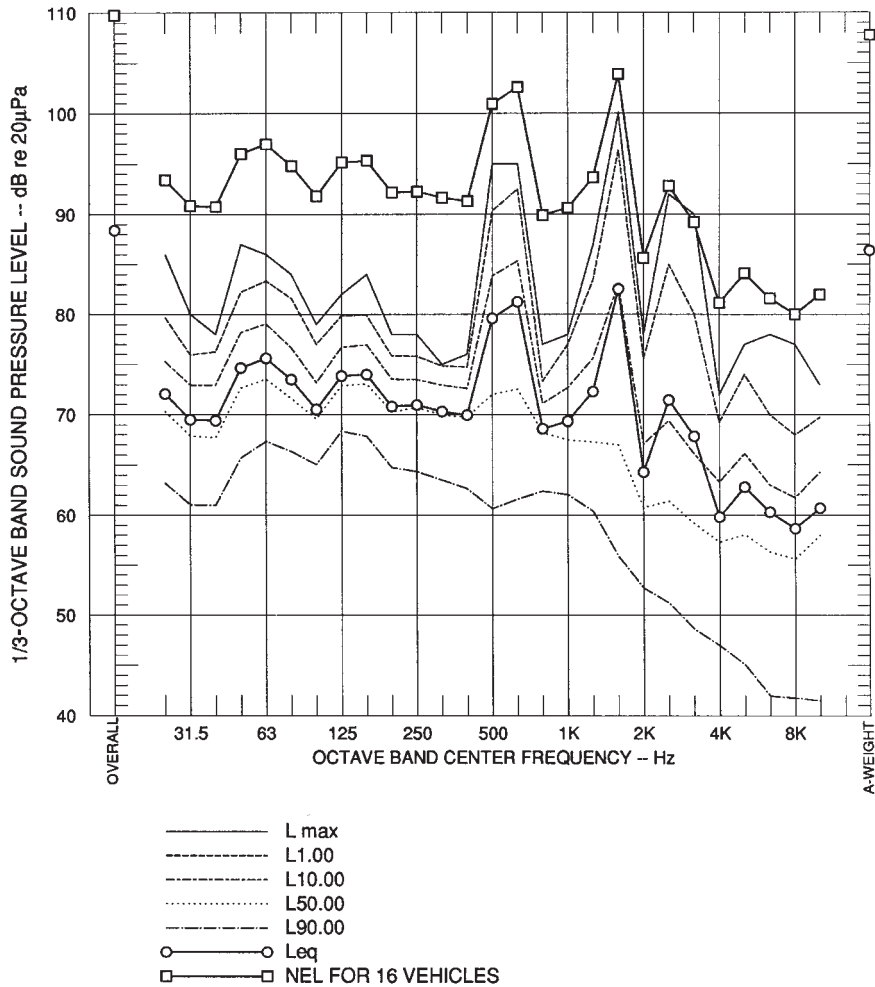

FIGURE 7-13 CURVING NOISE SACRAMENTO RTD, 51 FEET INSIDE OF 82-FT RADIUS CURVE - TRAINS AT 7 MPH

Santa Clara Transportation Agency. The Santa Clara Transportation Agency tested the Century Lubricating Oils HPF and LCF spring-loaded stick friction modifiers and found a 0 to 2 dB squeal noise reduction. Testing was discontinued when the dry sticks broke or were lost after less than 2,000 mi. The agency employs SAB resilient wheels

and rigidly embedded track in concrete. As of this writing, the agency has decided to try the dry-stick lubricants again, though no data are available.

The curve radius and use of resilient wheels appear to be larger factors in controlling wheel squeal than use of the HPF or LCF flange lubricant. However, the lack of squeal at the

TABLE 7-4 WHEEL SQUEAL NOISE REDUCTION DUE TO LUBRICATION AT CURVE - WMATA

TRACK CONDITION	MAXIMUM LEVEL - DBA -	STANDARD DEVIATION - DB -	SOUND EXPOSURE LEVEL - DBA -	STANDARD DEVIATION - DB -	DURATION - SEC -
DRY	103	2.7	109	2.9	29-32
LUBRICATED	87	9.0	93	6.2	25
LUBRICATED NEW APPLICATION	79	4.1	88	3.5	24

Los Angeles Blue Line 90- and 100-ft radius curves suggests that either (1) the lubrication of two axle sets of each vehicle is more effective in reducing squeal than lubrication of a single axle set as at Sacramento or (2) the embedded track design at Los Angeles with resilient rail support and elastomer road surface is more effective in reducing squeal than the ballast-and-tie track with asphalt and concrete road surface used at Sacramento.

The most popular theory of wheel squeal, discussed in Chapter 5, holds that damping of the track by rubberized grade crossing should have little effectiveness in controlling squeal. The Los Angeles Blue Line employs $\frac{1}{2}$ -in. gauge widening at the embedded curves, but also has a $\frac{1}{4}$ in. wider wheel flange gauge than other transit vehicles. The result is that there may be less crabbing of the truck in the curve than a normal standard gauge vehicle, which may reduce squeal. Another difference is that concavity of the tread running surface profile is evident in the tread profile of worn wheels at Sacramento, while at the Los Angeles Blue Line, wear appears to be less and the wheel treads appear to have a certain amount of taper. Thus, a rolling radius differential is promoted at the curves of the Los Angeles Blue Line, with attendant self-steering of the axles, thus, perhaps, lessening slip and squeal.

The concavity of the tread profile at the Sacramento RTD would not promote a rolling radius differential and self-steering, and thus may exacerbate squeal. At the Los Angeles Blue Line, the combined effect of wider wheel set gauge, tapered tread profile, curve radii of 90 ft or greater, resilient wheels, 115-lb/yd rail, and rubberized grade crossing and HPF tread and LCF flange lubrication may inhibit squeal.

7.14.3.3.2 Tangent Track

A modest noise reduction of at least 2 dB of wayside noise at tangent track in good condition is possible, due to reduction of roll-slip or other stick-slip behavior by use of friction modifiers, even with the rail in otherwise smooth condition. This mechanism of noise generation is considered significant by a number of researchers. (See section on theory of wheel/rail noise generation.) Modification of the friction versus creep velocity curve to avoid a negative slope of friction versus creep velocity would, presumably, tend to inhibit roll-slip behavior. The HPF friction modifier is designed to do this by mixing with oxides and wear debris from the rail and tread and forming a film which provides an effective friction coefficient of between 0.2 and 0.4, with a positive friction versus creep velocity slope. A good test of the effect of solid friction modifiers on tangent track rolling noise requires extensive running in over a period of several days or weeks to allow mixing of the friction modifier with surface oxides on the rail running rail surface.

The greatest potential for rolling noise reduction with use of friction modifiers may be in reducing rail corrugation rates. Reduction of corrugation rate is theoretically possible

for a treatment which eliminates the negative friction effect at the contact patch. Prevention of corrugation, either by friction modification, rail grinding, or a combination of both, can result in 10 to 15 dB noise reduction relative to poorly maintained, corrugated rail. Friction modifiers alone applied to corrugated or rough rail would probably not reduce noise, though the manufacturers indicate that a noise reduction of at least 2 dB may be expected in this case. More likely, a combination of profile grinding and application of a friction modifier to lengthen grinding intervals represents a most effective rail maintenance procedure, as indicated by the Vancouver Skytrain. Regardless of whether a friction modifier is used, there is no substitute for effective rail grinding. Following is a discussion of the experiences of various transit systems with HPF and tangent track noise control.

Vancouver Skytrain. The Vancouver Skytrain employs the Centrac HPF friction modifier and reports that noise levels actually go up if lubrication is suspended, even with frequent rail grinding (67). Further, the friction modifier is beneficial in reducing rail corrugation growth. The Skytrain vehicle has a steerable truck manufactured by UTDC with small wheel size and conical treads. Skytrain engages in frequent profile grinding and wheel truing.

BART. BART experimented with a solid lubricant applied to all wheels of a test train at the Hayward Test Track (68). Measurements of interior and exterior noise were conducted before and after treatment on recently ground tangent track in excellent condition. Approximately 80 runs were conducted by the train after treatment and prior to measuring the noise. The exterior test results are illustrated in Figure 7-14. Field test personnel indicated that the trains subjectively sounded quieter (after a period of a few days), but the objective test data indicated a 1.5 dBA increase in exterior noise at 50 mph. The interior noise test results, not shown here, indicated a 1 to 2 dB increase at 50 and 70 mph, with little change in spectrum.

The lack of agreement between subjective assessment of the noise and qualitative test data is an example of the difficulty and danger inherent in basing conclusions regarding noise reduction effectiveness on judgment, especially when changes in noise level are small or insignificant, as in the case of these test data. A 1 to 2 dB change in noise level is barely perceptible to the average person.

Santa Clara Transportation Agency. The Santa Clara Transportation Agency tested the Century Lubricating Oils HPF and LCF spring-loaded stick friction modifiers and found no rolling noise reduction. Testing was discontinued when the dry sticks broke or were lost after less than 2,000 mi.

Sacramento RTD. Wayside noise at 50 ft from a ballast-and-tie track were measured at the Sacramento RTD system. Train speeds were on the order of 50 mph. The results are presented in Figure 7-15, which indicates that wayside noise

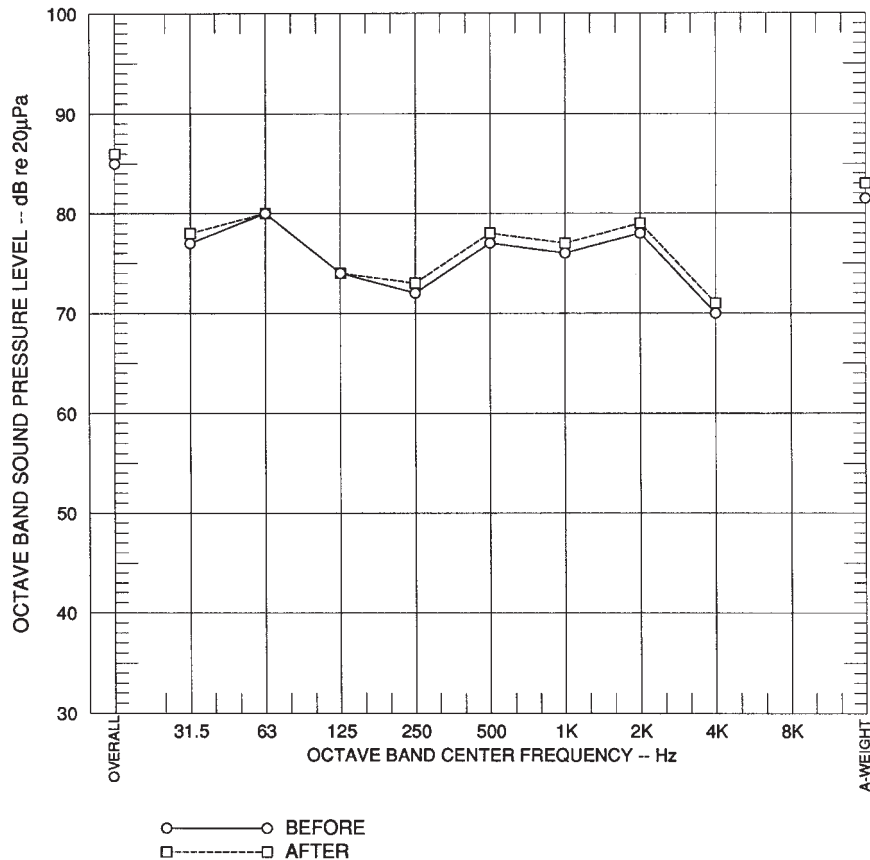

FIGURE 7-14 WAYSIDE NOISE AT 50 FEET FROM BALLAST-AND-TIE TRACK AT BART HAYWARD TEST TRACK BEFORE AND AFTER APPLICATION OF SOLID-STICK LUBRICANT

is on the order of 86 to 89 dBA at this section of track. Noise levels for trains at 50 ft from the adjacent track were about 83 to 85 dBA (not shown). A substantial pure tone component exists at about 630- and 800-Hz third octaves, related to rail corrugation. These results were obtained about 2 years after rail grinding with a Loram horizontal rail grinder. Major conclusions are (1) rail corrugation is not prevented by the HPF treatment, (2) corrugation is reemerging within a 2-year period after grinding, and (3) wayside noise levels are not necessarily reduced by the HPF dry-stick lubrication.

Measured wayside noise levels for systems with and without HPF treatment are compared in Figure 7-16. These data are for light rail vehicles traveling at between 45 and 55 mph on ballast-and-tie track. The data shown for Portland Tri-Met were obtained in 1989, several years after startup and pre-revenue service grinding, without HPF dry-stick lubrication. The data shown for the Sacramento RTD and Los Angeles Blue Line were obtained within 2 and 1.5 years after grinding, respectively, with a Loram horizontal axis grinder and with at least 1 year of application of HPF dry-stick lubrication. (The data were collected in May and June 1995.)

The data obtained for the Sacramento RTD and Los Angeles Blue Line clearly show a pronounced peak at about 800

Hz due to a wave in the rail head, confirmed by data obtained at varying speeds. Visual observation suggests that the wave is minor rail corrugation. However, the rail grinder could conceivably have contributed to the wave as well, though one might expect that the grinding artifact would have been worn away with time. (The same horizontal axis grinder was used at the Sacramento RTD and Los Angeles Blue Line.)

During the measurement, wheel/rail howl was observed, further suggesting the presence of corrugation. The results do not indicate that the dry-stick lubrication is effective in preventing rail corrugation, nor that it is effective in reducing noise levels relative to those observed at the Portland Tri-Met system for trains running without dry-stick lubrication. This is not to say that HPF does not reduce noise or corrugation rates, only that these data do not indicate this. Tri-Met has also met with substantial corrugation noise prior to recent rail grinding efforts and experimentation with HPF dry-stick lubrication.

7.14.3.4 Costs

The costs for friction modifiers vary. Metro-Dade County reports a capital cost of \$80,000 and maintenance cost of \$15,000 per vehicle per year for the Phymet solid lubricant

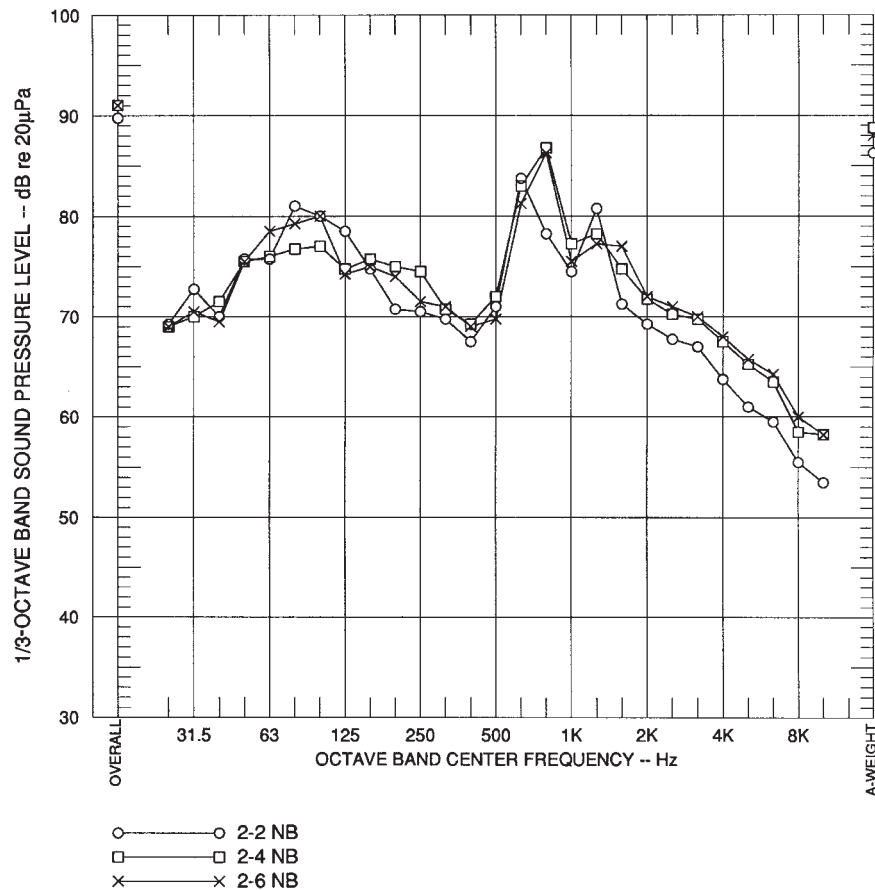

FIGURE 7-15 TANGENT TRACK PASSBY NOISE FOR SACRAMENTO RTD TRAINS WITH RESILIENT WHEELS AND HPF DRY-STICK LUBRICATION

system. Phymet has not been contacted regarding projected costs. However, these costs would be presumed to be competitive with those of other solid-stick lubricants.

The Bi-State Development Agency employs graphite lubricator sticks for wheel flange lubrication at the St. Louis MetroLink. The sticks are supplied by Kelsan Lubricants Ltd. at a capital cost of \$25,000. This would presumably be the LCF flange lubricant.

WMATA indicated that onboard flange and tread lubrication was estimated to cost about \$500 per truck per month, or about \$12,000 per vehicle per year.

Kelsan Lubricants Inc. indicates that the cost of combined LCF and HPF lubrication includes a one-time cost of \$800 to \$1,000 for brackets plus perhaps 1 hour installation time, followed by a product cost of about \$1,500 per vehicle per year, assuming four wheels per vehicle are lubricated. Product installation time is estimated to be about 10 min per vehicle during normal servicing, at 16,000- to 18,000-mi intervals. Based on a survey of various transit systems, the overall costs are \$1,400 per vehicle per year for HPF tread lubricant and \$1,200 per vehicle per year for LCF flange lubricant. Lubricant usage varies with degree of tread and

flange roughness. Kelsan further indicated that users report that surface finish improves dramatically over time, with the result that stick usage should drop over time, and bears further investigation.

7.14.3.5 Site-Specific Conditions

There are no published data concerning site-specific conditions, though wet weather could conceivably wash much of the lubricant from the rail, thus inhibiting formation of the oxide/lubricant film over time. This may be a reason why the dry-stick lubrication experiment by Portland Tri-Met was inconclusive as of this writing.

No data have been obtained concerning the environmental hazards of dry-stick lubricant. According to one report, the HPF material consists of a polyester resin with molybdenum disulfide (69). The manufacturer of HPF indicates that the material is manufactured from polyester and rare earths.

An engineer at WMATA expressed a concern with respect to train signaling due to excessive resistance caused by tread lubrication. Similar concerns were identified by Kramer (70).

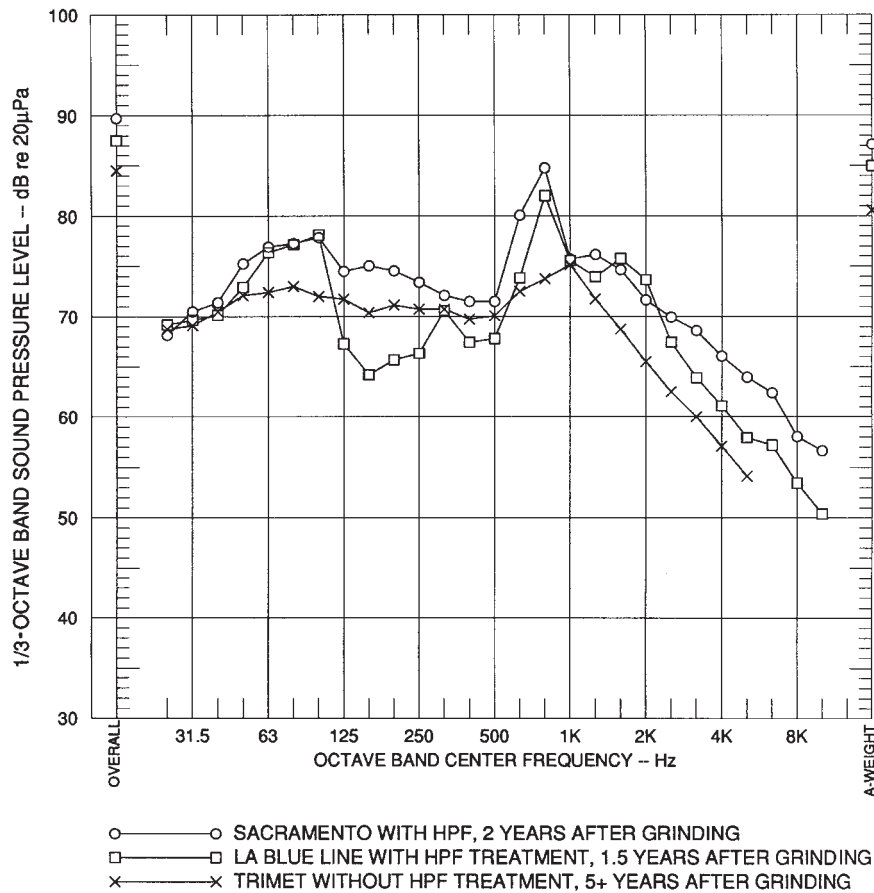

FIGURE 7-16 COMPARISON OF WAYSIDE NOISE LEVELS FOR LIGHT RAIL TRANSIT VEHICLES ON BALLAST-AND-TIE TRACK WITH AND WITHOUT HPF SOLID LUBRICANT - RESILIENT WHEELS

However, no difficulties with train signaling were reported by Los Angeles Blue Line or Sacramento RTD.

7.14.3.6 Application Techniques

Onboard application of dry-stick lubricants is accomplished by spring-loaded brackets which apply the stick lubricant directly to the flange and tread surfaces. The greatest difficulty experienced with applying dry lubricants as onboard treatment for wheel/rail noise control appears to be rattling noise from the brackets and failure of the brackets. Proper design of the brackets should eliminate these problems. Figure 7-17 illustrates the mounting brackets used at the Sacramento RTD and Los Angeles Blue Line. Both LCF and HPF flange lubricators are shown.

Care must be exercised during bracket installation to ensure that the brackets do not make noise, as was reported by some systems. The manufacturer should warrant that the brackets will not squeal or rattle during vehicle use.

7.15 CAR BODY SOUND INSULATION

An effective car body design is important for controlling car interior noise and patron and vehicle operator noise expo-

sure. Although no data have been obtained, ridership may be affected by noise, and systems interested in attracting patronage and improving ridership can ill afford to have unnecessarily high car interior noise levels. Modern transit vehicles today are quiet compared with vehicles built before 1960. However, older vehicles are still in use, and, at some systems, vehicles may be operated in a subway with open windows, as with streetcars, thus exposing patrons to very high noise levels, sufficient to prevent conversation of any sort during passage through tunnels. Further, the noise from corrugated rail and wheel squeal in tunnels can be uncomfortable to patrons.

7.15.1 Vehicle Procurement Specifications

The primary purpose of reducing vehicle noise is to produce a reasonably pleasant environment for patrons, allow conversation with normal vocal effort, and reduce overall patron and operator noise exposure. The inclusion of vehicle noise criteria or standards as part of vehicle procurement specifications is one of the best methods of ensuring that noise exposure goals are achieved. To this end, the APTA guidelines discussed earlier in this manual are designed to ensure that state-of-the-art techniques are used to minimize

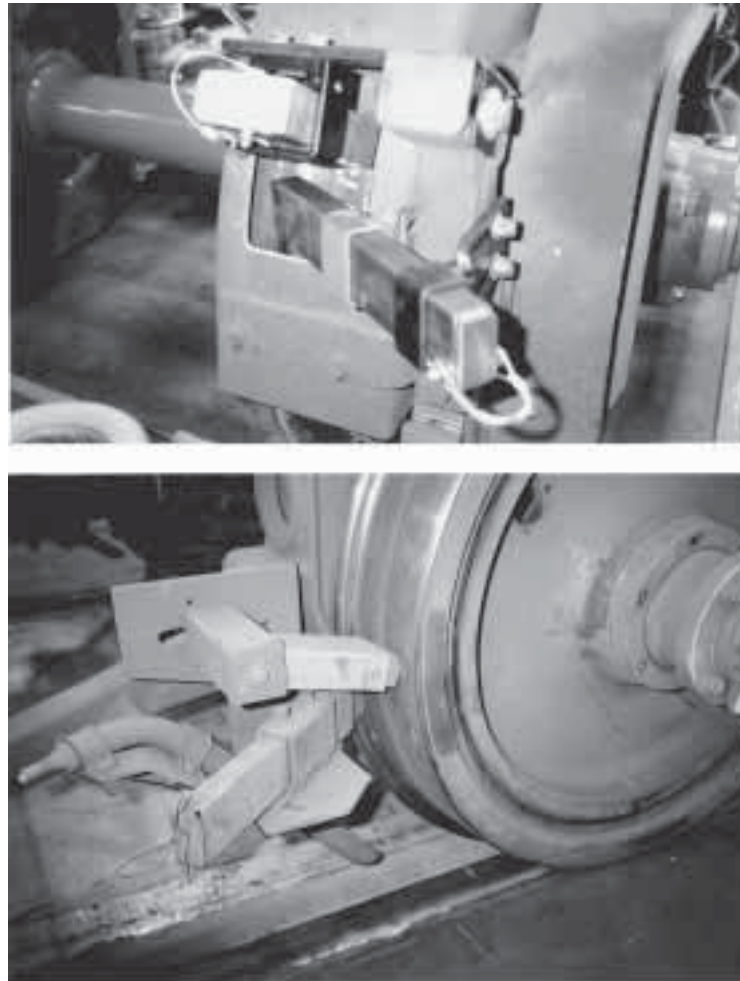

FIGURE 7-17 LCF AND HPF MOUNTING BRACKETS AT SACRAMENTO RTD (UPPER PHOTO) AND LOS ANGELES BLUE LINE (LOWER)

noise and create a reasonably pleasant interior noise environment. Meeting APTA guidelines means that at low speeds on ballast-and-tie track, the subjective rating of the interior noise is “quiet,” while at high speeds in subways the level is “intrusive” but not annoying. The vehicle noise design goals given in the APTA guidelines are based on a balance between desirable and economically feasible noise environments. The noise limits provided in the guidelines are achievable and practical and are based on measurements of modern rail transit vehicle noise.

7.15.2 Sound Transmission Loss Requirements

Sufficient sound insulation or transmission loss of the car body floor, wall, and ceiling assemblies is necessary to achieve the design goal interior noise levels of the APTA guidelines. At speeds in excess of about 50 km/hr, noise from the air conditioning systems and other auxiliaries is

dominated by propulsion system and wheel/rail noise. In subways, wheel/rail noise is normally the dominant source. Because both of these sources are outside of the car body shell, the transmission loss of the floor, walls, ceiling, windows, and doors determine the interior noise of the car, especially when operating at high speed. The transmission loss of the floor is most important for operation on at-grade ballast-and-tie track or concrete aerial structures, because the dominant noise sources are located beneath the floor, and sound is radiated away from the vehicle. The transmission loss of the walls, ceiling, windows, and especially the doors are most important for operation in subways, where the sound energy is confined to the train tunnel annulus.

The sound energy transmitted by mechanical vibration from the trucks to the body of a modern transit vehicle supported by air springs is normally far below the airborne sound energy transmitted through the car body elements. Therefore, enhancement of the transmission loss of the car

body elements is one of the best available means of reducing car interior noise. Efforts directed at detecting body leaks and effectively sealing them are usually successful and desirable. Even on modern transit vehicles, door seals become worn, or they are removed during the course of maintenance. Replacement of door seals may be sufficient to return a transit vehicle to its original noise control performance.

A field sound transmission loss test is desirable to determine whether the transmission loss of the car body elements is sufficient to achieve car interior noise limits. The required sound transmission loss at each of four frequencies for the various car body elements are usually part of modern new car procurement specifications. The sound transmission loss test procedures are outlined in ASTM E 336-71, as revised, Recommended Practice for the Measurement of Airborne Sound Insulation in Buildings. (An example of sound transmission loss requirements is provided in Table 17 of that document, excerpted from the Chicago CTA transit car procurement specifications for the 2600 Series vehicles.)

7.15.3 Car Body Designs

The vehicle shell should be a nonhomogeneous sandwich barrier composed of two impervious barriers separated by a layer of sound absorbing material. The sandwich wall type provides superior transmission loss for the equivalent mass of the wall. The superior performance of the sandwich wall is now generally recognized and has been successfully incorporated into numerous transit vehicle designs. When the separation of the impervious layers is too small, or the areal density of one or both of the barriers is too low, there is a loss of sound isolation in the low- and mid-frequency ranges.

Figures 7-18, 7-19, and 7-20 illustrate the floor, wall, and ceiling constructions for the State-of-the-Art-Car (SOAC) tested at the Transportation Test Center in Pueblo, Colorado, and at various transit systems. A new transit vehicle utilizing these features for car body construction would meet the sound transmission loss requirements of the CTA specifications or other similar new vehicle specifications. The sound transmission loss effectiveness of these elements must not be reduced by flanking paths around windows, doors, ventilation ducts, floor penetrations for cables and pipes, through-wall penetrations for heating elements, and so forth. Flanking paths can be minimized by proper design and careful workmanship of window molds and door paths (effective brush seals) and proper sealing of any necessary penetrations through the inner liner or through the floor. Usually, sealing the floor penetrations is the most critical requirement. Older transit vehicles can be modified to significantly improve the interior noise environments. Possible improvements include sealing doors and windows and providing forced air ventilation or conditioning.

The life expectancy of the vehicle must be considered in the cost of any retrofit. If the vehicle is to be retired within 5 years or so, the cost effectiveness of acoustically improving the car is questionable. However, if there still is a long life expectancy or if the car is to be rebuilt for nonacoustical reasons, a significant improvement in the vehicle acoustics can be achieved at a relatively low cost. An extensive study done at the MTA NYCT to determine ways of quieting older subway cars showed that 10 to 15 dB noise reduction, in most cases, could be achieved inside the car by treating door seals, traction motor fan, and floor, for an estimated cost of less than \$25,000 per car (1979 dollars), exclusive of air conditioning costs. However, noise from traction systems, ancillary equipment, and fans must be considered in designing an overall noise control strategy.

TABLE 7-5 SOUND TRANSMISSION LOSS REQUIREMENTS FOR CAR BODY COMPONENTS (72)

OCTAVE BAND CENTER FREQUENCY	ENTIRE FLOOR	WALLS AND WINDOWS	CEILING OR ROOF	DOORS
250	27	23	23	14
500	35	31	31	22
1,000	38	34	34	25
2,000	38	34	34	25

Note: The sound transmission loss shall be averaged over each characteristic section of the car body defined in the above table, and must include the influence of all sound energy which transmits through all weak areas such as apertures, door seals, air ducts, or openings for supply and return ducts.

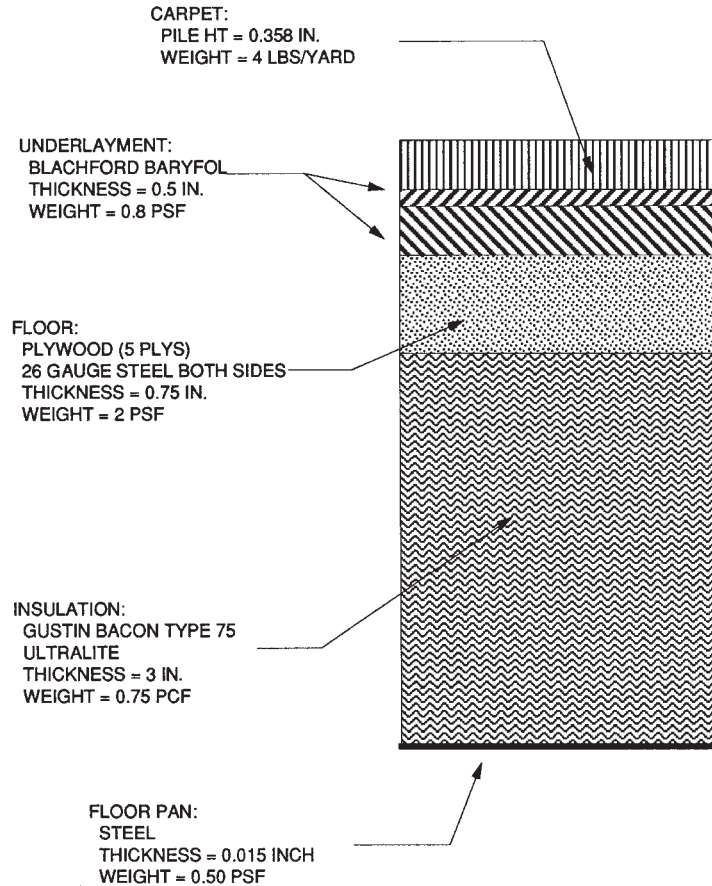

FIGURE 7-18 CAR BODY NOISE REDUCTION FEATURES, FLOOR

7.15.4 Doors

There are three types of doors typically used on rail transit vehicles:

- Sliding doors—The doors slide on an upper and lower track into and out of a pocket in the wall of the car.
- Bifold doors—Each of the two door parts is hinged in the middle and at the connection to the car wall, so that as they open or close from the center, the door simply folds out of the way against the car wall. The bifold door is not generally used in new cars due to access requirements for disabled patrons.
- Plug doors—Similar to the sliding door configuration, the doors slide on a track which takes them outside of the vehicle wall instead of sliding into a car wall pocket.

Plug doors are used on the SLRV and provide superior sound insulation characteristics due to their positive sealing nature, whereas both sliding and bifold doors allow sound leakage along the vertical edges of the door as well as at the door tracks. The sound insulation characteristics of the bifold door are less desirable than those of the other two configura-

tions. Not only are there leaks about the periphery of the door, but the hinged joint also provides a sound transmission path. Further, the light weight of the bifold door usually does not provide sufficient sound insulation for a modern transit vehicle.

Door operation noise must be considered in the overall noise control of the transit vehicle. Sliding doors are the type in use at most newer transit systems. These doors are fast operating and are generally efficient and relatively quiet when moving. However, due to their size and weight, significant impact noise can be generated when the doors are unlocked and when the doors are closed. The bifold doors may also generate significant impact noise when unlocking or when closing, though they are typically quieter than the other two configurations.

An example of the importance of door seals in controlling noise between the doors of a BART transit vehicle is illustrated in Figure 7-21 (71). In this example, the A-weighted noise level between the doors of a 20+-year-old BART vehicle traveling in subway on ground rail with worn or nonexistent door seals was 91 dBA. Replacement of the seals reduced the noise level to about 85 dBA. Further, sealing the door joints and jams with aluminized duct tape reduced the

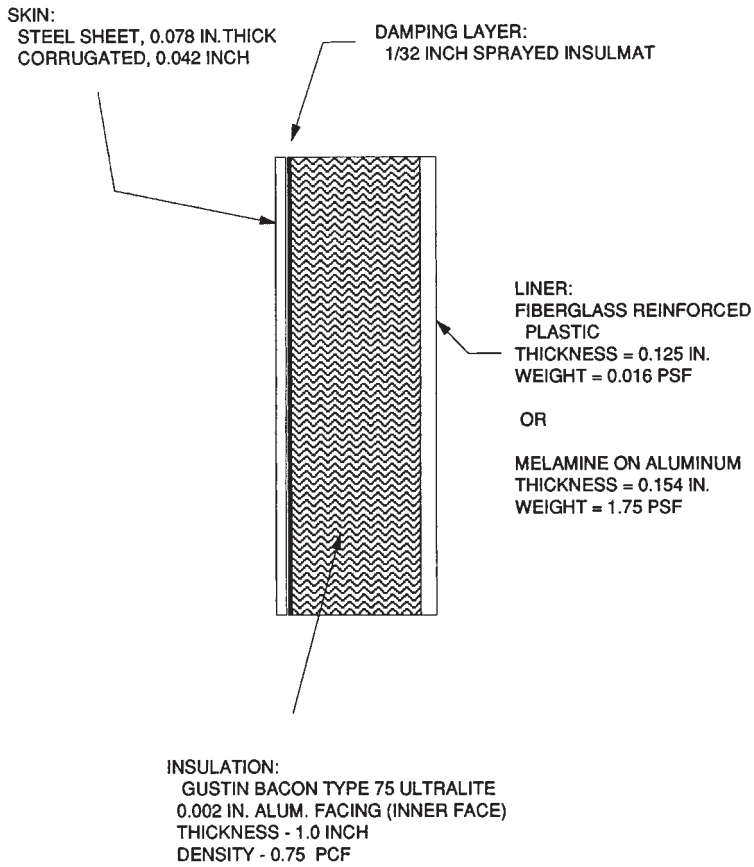

FIGURE 7-19 CAR BODY NOISE REDUCTION FEATURES, WALL

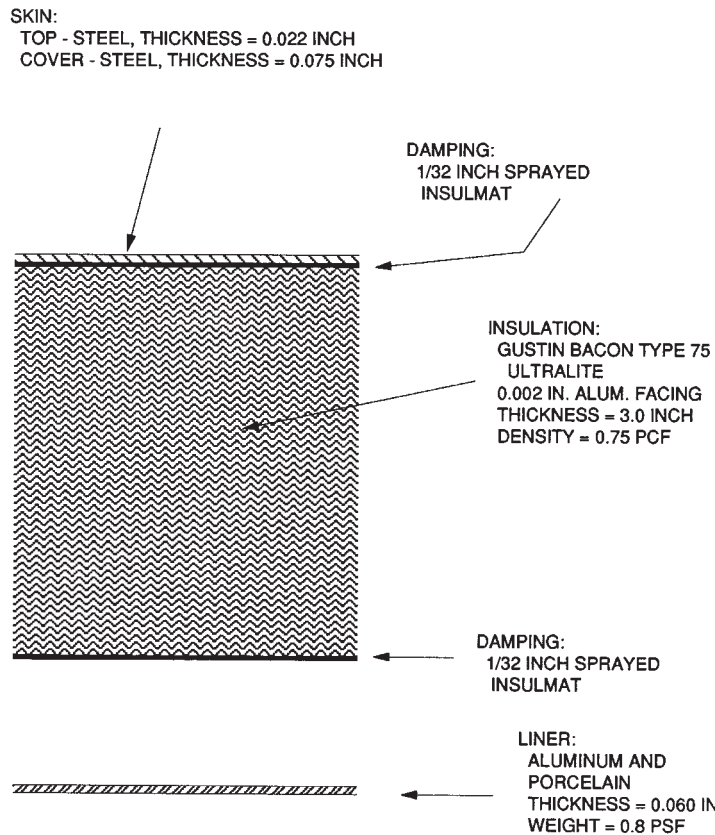

FIGURE 7-20 CAR BODY NOISE REDUCTION FEATURES,
CEILING

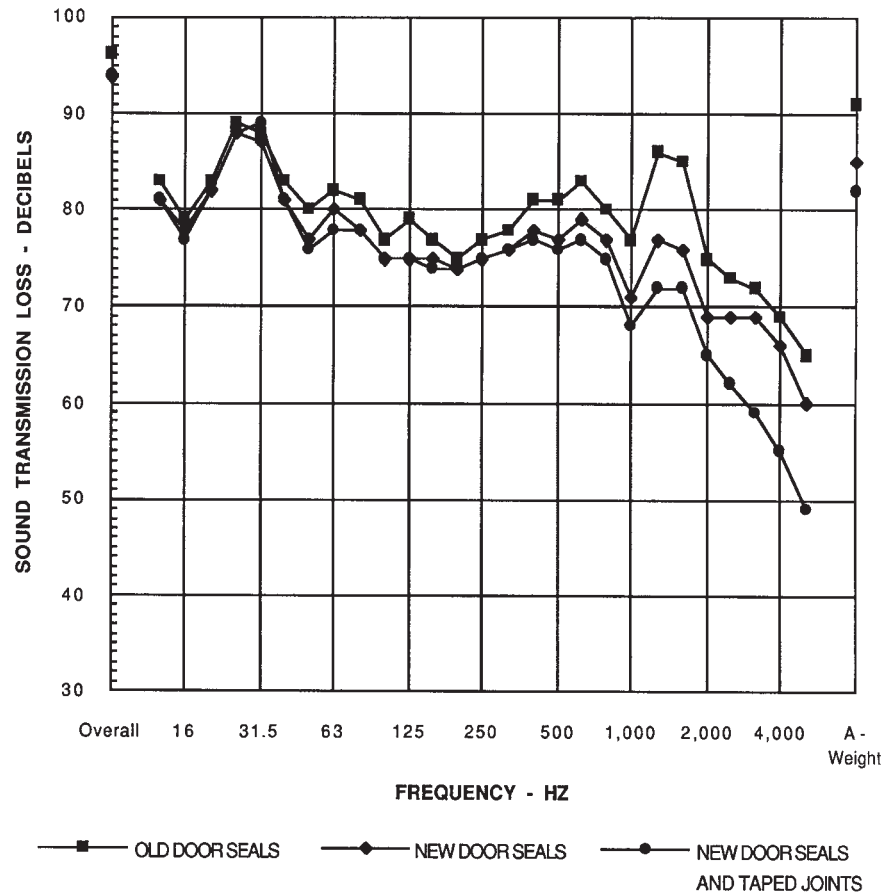

FIGURE 7-21 NOISE LEVELS BETWEEN SLIDING DOORS OF BART CARS IN SUBWAY AT 66 MPH ON GROUND RAIL

noise to about 81 dBA. These data clearly show the importance of door seals in maintaining an acceptable car interior noise level, both for new and existing vehicles. (The peak in the spectrum at about 1,250 Hz is due to a rail grinding pattern. Removal of this pattern would further reduce car interior A-weighted noise.)

7.16 REFERENCES

1. Fischer, H.M., "Noise Generation by Railroad Coaches," *Journal of Sound and Vibration*, Vol. 66, No. 3 (1979), pp. 333-349.
2. Kalousek, J., and K.L. Johnson, "An Investigation of Short Pitch Wheel and Rail Corrugations on the Vancouver Mass Transit System," *Proc., Instn. Mech. Engrs.*, Vol. 206 (1992).
3. Remington, P.J., *Wheel/Rail Rolling Noise Generation and Control*, TCRP Project C3, BBN Systems and Technologies, for Wilson, Ihrig & Associates, Inc. (September 1994).
4. Nelson, P. J., ed., *Transportation Noise Reference Book*, Butterworths, London (1987), Chapter 15.
5. Kurzweil, L.G., and L.E. Wittig, *Wheel/Rail Noise Control—A Critical Evaluation*, Bolt Beranek & Newman, Inc., for UMTA/U.S.DOT, Report UMTA-MA-06-0099-81-1, p. 81.
6. Dittrich, M.G., F.J.W. Biegstraaten, P.C.G.J. Dings, and D.J. Thompson, "Wheel Roughness and Railway Rolling Noise—The Influence of Braking Systems and Mileage," *Rail Engineering International*, No. 3. (1994), pp. 17-19.
7. Abbot, D.J., *Rail/Wheel Noise: A Rolling Stock Manufacturer's Perspective*, ABB Transportation Ltd., U.K.
8. Kurzweil, L.G., and L.E. Wittig, *Wheel/Rail Noise Control—A Critical Evaluation*, Interim Report, Bolt, Beranek & Newman, Inc., for UMTA/U.S. DOT (January 1981), pp. 73-75.
9. Survey questionnaire.
10. Remington, P. J., N. R. Dixon, and L. E. Wittig, *Control of Wheel/Rail Noise and Vibration*, Final Report, Bolt, Beranek & Newman, Inc., for Transportation Systems Center/U.S. DOT, NTIS Report UMTA-MA-06-0099-82-5 (April 1983), pp. 289-317.
11. Remington, P. J., N. R. Dixon, and L. E. Wittig, *Control of Wheel/Rail Noise and Vibration*, Final Report, Bolt, Beranek & Newman, Inc., for Transportation Systems Center/U.S. DOT, NTIS Report UMTA-MA-06-0099-82-5 (April 1983), p. 309.
12. Suda, Y., and H. Komine, "Contact Vibration With High Damping Alloy," *Contact Mechanics and Wear of Wheel/Rail Systems*, Preliminary Proceedings, J. Kalousek, ed. (1994).
13. Duerig, T.W., K.N. Melton, D. Stockel, and C.M. Wayman, *Engineering Aspects of Shape Memory Alloys*, Butterworth-Heinemann, London (1990), p. 21.
14. Remington, P. J., N. R. Dixon, and L. E. Wittig, *Control of Wheel/Rail Noise and Vibration*, Final Report, Bolt, Beranek & Newman, Inc., for Transportation Systems Center/U.S. DOT,

- NTIS Report UMTA-MA-06-0099-82-5 (April 1983), pp. 271–289.
15. Personal communication with J. Kremme, formerly of Raychem Corp., inventor of Nitinol wheel treads.
 16. Kumar, S., P. Matic, A. Parmaksizglu, C. Sciammarella, and S. Rao Kilaparti, *Preliminary Investigation of Nitinol Wheel/Rail Steel Adhesion Creep and Wear Characteristics*, Final Report, Illinois Institute of Technology, for Raychem Corp., Report IIT-TRANS-78-5 (June 1978), 50 pp.
 17. Quilter, R. J., and E. L. Van Sickle, “Quiet Progressive a Railroad Wheel,” *Metropolitan* (March-April 1975), pp. 10–12.
 18. Personal communication from W. Keevil of Chicago CTA.
 19. Quilter, R. J., and E. L. Van Sickle, “Quiet Progressive a Railroad Wheel,” *Metropolitan* (March-April 1975), pp. 10–12.
 20. Saurenman, H.J., R.L. Shipley, and G.P. Wilson, *In-Service Performance and Costs of Methods to Control Urban Rail System Noise*, Final Report, Wilson, Ihrig & Associates, Inc., for UMTA/U.S. DOT, Report UMTA-MA-06-0099-80-1 (December 1979).
 21. Wilson, G.P., *BARTD Car 107 Noise Tests with Standard, Damped, and Resilient Wheels*, Wilson, Ihrig & Associates, Inc., for Parsons, Brinckerhoff Tudor-Bechtel (June 21, 1972).
 22. Saurenman, H.J., R.L. Shipley, and G.P. Wilson, *In-Service Performance and Costs of Methods to Control Urban Rail System Noise*, Final Report, Wilson, Ihrig & Associates, Inc., for UMTA/U.S. DOT, Report UMTA-MA-06-0099-80-1 (December 1979).
 23. Rickley, E.J., and M.J. Brien, *Noise Test-Resilient Wheels Massachusetts Bay Transportation Authority Green Line*, Final Report, Transportation Systems Center, for UMTA/U.S. DOT, Report UMTA-MA-06-0099-82-4 (November 1982).
 24. London Transport, Office of the Scientific Advisor, “Report on the Effectiveness of Noise Damping Rings on Train Wheels,” *Investigations into Noise on Railways*, Laboratory Investigation 128/X215 (September 30, 1974).
 25. Quilter, R. J., and E. L. Van Sickle, “Quiet Progressive a Railroad Wheel,” *Metropolitan* (March-April 1975), pp. 10–12.
 26. Nelson, J.T., Wheel/Rail Noise at the Los Angeles Blue Line, Technical Memorandum for TCRP Project C3.
 27. Rutty, F. G. *Resilient Wheels—Experience of London Transport*, London Transport Report 8/74-c239 (revised September 13, 1974).
 28. Personal communication with BART engineers, and personal knowledge of the author.
 29. Personal observation of the author.
 30. Nelson, J.T., Wheel/Rail Noise at the Los Angeles Blue Line, Technical Memorandum for TCRP Project C3 (1996).
 31. *CLRV Noise and Vibration Study*, Final Report, Toronto Transit Commission, CLRV Noise and Vibration Study Working Committee (March 1983).
 32. *CLRV Noise and Vibration Study*, Final Report, Toronto Transit Commission, CLRV Noise and Vibration Study Working Committee (March 1993), pp. 1–5.
 33. Correspondence from Penn Machine to Wilson, Ihrig & Associates, Inc. (November 9, 1994).
 34. Manning, J. E. *In-Service Evaluation of Four Types of Damped Subway Car Wheels*, U.S. DOT (draft).
 35. Personal communication with W. Keevil of Chicago CTA.
 36. Wilson, G.P., *BARTD Prototype Car 107 Noise Tests With Standard, Damped, and Resilient Wheels*, Final Report, Wilson, Ihrig & Associates, Inc., for Parsons, Brinckerhoff Tudor-Bechtel (June 21, 1972), p. 17.
 37. Wilson, G.P., *BARTD Prototype Car 107 Noise Tests With Standard, Damped, and Resilient Wheels*, Final Report, Wilson, Ihrig & Associates, Inc., for Parsons, Brinckerhoff Tudor-Bechtel (June 21, 1972), p. 17.
 38. Saurenman, H.J., R.L. Shipley, and G.P. Wilson, *In-Service Performance and Costs of Methods to Control Urban Rail System Noise*, Wilson, Ihrig & Associates, Inc., for UMTA/U.S. DOT, Report UMTA-MA-06-0099-80-1 (draft).
 39. Manning, J. E., *In-Service Evaluation of Four Types of Damped Subway Car Wheels*, U.S. DOT (draft).
 40. Wolfe, S.L., *Noise and Vibration Test Report—2400 Series Rapid Transit Cars*, Final Report, Wilson, Ihrig & Associates, Inc. (June 1977).
 41. CTA Ring Damped Wheel Noise Test Report, Boeing Vertol Interoffice Memorandum (May 19, 1975).
 42. Wolfe, S. L., *Noise and Vibration Test Report—2400 Series Rapid Transit Cars*, Final Report, Wilson, Ihrig & Associates, Inc. (June 1977).
 43. CTA Ring Damped Wheel Noise Test Report, Boeing Vertol Interoffice Memorandum (May 19, 1975).
 44. Adtranz report concerning test results at WMATA West Falls Church yard (1996).
 45. Barsikov, B., W.F. King III, and E. Pfizenmaier, Wheel/Rail Noise Generated by a High Speed Train Investigated with a Line Array of Microphones, *Journal of Sound and Vibration*, Vol. 118, No. 1 (1987), pp. 99–122.
 46. Wilson, G.P., *BART Prototype Car 107 Noise Tests with Standard, Damped and Resilient Wheels: Ballast and Tie Tangent Track and Short Radius Subway Curves*, Final Report, Wilson, Ihrig & Associates, Inc., for Parsons Brinckerhoff Tudor-Bechtel (June 21, 1972), p. 14.
 47. Hanson, C.E., M. Schafer, D. Towers, and K. Eldred, *Noise Control for Rapid Transit Cars on Elevated Structures: Preliminary Investigation of Vehicle Skirts, Undercar Absorption, and Noise Barriers*, Final Report, Bolt, Beranek & Newman, Inc., for UMTA/U.S. DOT, Report UMTA-MA-06-0099-80-4, p. 13.
 48. Hanson, C.E., M. Schafer, D. Towers, and K. Eldred, *Noise Control for Rapid Transit Cars on Elevated Structures: Preliminary Investigation of Vehicle Skirts, Undercar Absorption, and Noise Barriers*, Final Report, Bolt, Beranek & Newman, Inc., for UMTA/U.S. DOT, Report UMTA-MA-06-0099-80-4, p. 33.
 49. Kurzweil, L.G., and L.E. Wittig, *Wheel/Rail Noise Control—A Critical Evaluation*, Interim Report, Bolt, Beranek & Newman, Inc., for UMTA/U.S. DOT (January 1981), pp. 78–79.
 50. Hanson, C.E., M. Schafer, D. Towers, and K. Eldred, *Noise Control for Rapid Transit Cars on Elevated Structures: Preliminary Investigation of Vehicle Skirts, Undercar Absorption, and Noise Barriers*, Final Report, Bolt, Beranek & Newman, Inc., for UMTA/U.S. DOT, Report UMTA-MA-06-0099-80-4.
 51. Ban, Y., and T. Miyamoto, Noise Control of High-Speed Railways, *Journal of Sound and Vibration*, Vol. 43, No. 2 (1975), pp. 273–280.
 52. Hanson, C.E., M. Schafer, D. Towers, and K. Eldred, *Noise Control for Rapid Transit Cars on Elevated Structures: Preliminary Investigation of Vehicle Skirts, Undercar Absorption, and*

- Noise Barriers*, Final Report, Bolt, Beranek & Newman, Inc., for UMTA/U.S. DOT, Report UMTA-MA-06-0099-80-4, p. 32.
53. Kurzweil, L.G., and L.E. Wittig, *Wheel/Rail Noise Control—A Critical Evaluation*, Interim Report, Bolt, Beranek & Newman, Inc., for UMTA/U.S. DOT, Report UMTA-MA-0099-81-1, pp. 75–77.
 54. Wilson, G. P., *Noise Levels From Operations of CTA Rail Transit Trains*, Wilson, Ihrig & Associates, Inc., for Chicago Transit Authority (May 1977).
 55. Lee, P.Y., Wilson, Ihrig & Associates, Inc., Letter Report to K. Thorn-Olsen, Parsons, Brinckerhoff Tudor-Bechtel, concerning BARTD Prototype Car 107 tests with standard and soft rubber axle bushings (April 17, 1972).
 56. Manufacturer's literature supplied by American Track Systems, Inc., Shrewsbury, PA.
 57. Kramer, J.K., "Rail Lubrication: A Solid Future?", *Railway Track and Structures* (November 1994), pp. 31–33.
 58. Century Lubricating Oils trade literature, provided by Kelsan, Inc.
 59. Kramer, J.K., "Rail Lubrication: A Solid Future?", *Railway Track and Structures* (November 1994), p. 31.
 60. TCRP Project C3 survey questionnaire return.
 61. TCRP Project C3 survey questionnaire return.
 62. TCRP Project C3 survey questionnaire return.
 63. Personal communication with St. Louis MetroLink engineers.
 64. Letter Report from Navcon Engineering to Century Lubricating Oils concerning acoustical measurements performed by Navcon at Sacramento, January 8, 1992 (obtained from Kelsan Lubricants, Inc.).
 65. Nelson, J.T., *Wheel/Rail Noise at the Sacramento Regional Transit System*, Technical Memorandum on TCRP Project C3, Wilson, Ihrig & Associates, Inc., for Transit Cooperative Research Program (May 16, 1995), pp. 23–32.
 66. TCRP Project C3 survey questionnaire return.
 67. Vidan, J., B.C. Transit, private communication.
 68. Wilson, G. P., Letter Report to Jerry McCleary, San Francisco Bay Area Rapid Transit District (October 29, 1993).
 69. Letter Report to Jeff Meloy, Century Lubricating Oils, from M. Staiano, Staiano Engineering, summarizing the results of field tests at WMATA (January 2, 1992) (available from Kelsan Lubricants).
 70. Kramer, J.K., "Rail Lubrication: A Solid Future?", *Railway Track and Structures* (November 1994), p. 33.
 71. Jue, D.A., and J.T. Nelson, *BART A&B Car Rehabilitation Car Interior Noise Tests, Original B-Cars with New Doors*, Wilson, Ihrig & Associates, Inc., for Booz, Allen, Hamilton, Inc. (December 15, 1995).
 72. Saurenman, H.J., J.T. Nelson, and G.P. Wilson, *Handbook of Urban Rail Noise and Vibration Control*, Wilson, Ihrig & Associates, Inc., for UMTA/U.S. DOT, DOT-TSC-UMTA-81-72, NTIS UMTA-MA-06-0099-82-1 (February 1982).
-

This page left intentionally blank.

CHAPTER 8 TRACKWORK TREATMENTS

- 8.1 Introduction, 143
- 8.2 Rail Grinding, 143
 - 8.2.1 Overview of Rail Grinding, 143
 - 8.2.1.1 Surface Defects (Level 1), 146
 - 8.2.1.2 Profile Grinding (Level 2), 147
 - 8.2.1.3 Rail Grinders, 154
 - 8.2.1.4 Economics of Rail Grinding, 154
 - 8.2.1.5 Limitations, 156
- 8.3 Gauge Widening versus Narrowing, 156
- 8.4 Double Restrained Curves, 156
- 8.5 Rail Joint Welding, 157
 - 8.5.1 Noise Reduction Effectiveness, 157
 - 8.5.2 Site-Specific Conditions, 157
 - 8.5.3 Costs, 157
- 8.6 Rail Vibration Absorbers, 157
 - 8.6.1 Products, 157
 - 8.6.2 Noise Reduction Effectiveness, 157
 - 8.6.3 Site Considerations, 158
 - 8.6.3.1 Elevated Structures, 158
 - 8.6.3.2 Temperature, 158
 - 8.6.3.3 Snow/Ice, 158
 - 8.6.3.4 Ballast-and-Tie Track, 158
 - 8.6.4 Cost, 158
- 8.7 Rail Dampers, 158
- 8.8 Resilient Rail Fasteners, 159
 - 8.8.1 Characteristics, 160
 - 8.8.1.1 Static Stiffness, 160
 - 8.8.1.2 Dynamic versus Static Stiffness, 160
 - 8.8.1.3 Top Plate Bending, 160
 - 8.8.2 Rail Damping, 160
 - 8.8.3 Products, 160
 - 8.8.4 Steel Elevated Structures, 160
 - 8.8.5 Costs, 161
 - 8.8.6 Site-Specific Conditions, 161
- 8.9 Special Trackwork, 161
 - 8.9.1 Types of Frogs and Manufacturers, 161
 - 8.9.1.1 Rail Bound Manganese Frogs, 161
 - 8.9.1.2 Welded Vee Frogs, 161
 - 8.9.1.3 Flange Bearing Frogs, 161
 - 8.9.1.4 Moveable Point Frogs, 162
 - 8.9.1.5 Spring Frogs, 162
 - 8.9.2 Noise Reduction Effectiveness, 162
 - 8.9.3 Costs, 162
 - 8.9.4 Site-Specific Conditions, 163

- 8.10 Rail Lubrication, 163
 - 8.10.1 Background, 163
 - 8.10.2 Acoustical Benefits, 164
 - 8.10.3 Lubrication Application Techniques, 164
 - 8.10.4 Current Railroad and Transit Practices, 165
 - 8.10.5 Rail Lubrication Cautions, 165
 - 8.10.6 Economic Considerations, 166
 - 8.10.7 Lubricant Products and Manufacturers, 166
 - 8.10.8 Site-Specific Conditions, 166
 - 8.10.8.1 Temperature, 166
 - 8.10.8.2 Rainfall, 166
 - 8.10.8.3 Track Grade, 166
 - 8.10.8.4 Electrical Contact, 166
 - 8.10.8.5 Environmental Pollution, 167
- 8.11 Ballasted Track, 167
- 8.12 Trackbed Sound Absorption, 167
- 8.13 Hardfacing, 167
 - 8.13.1 Noise Reduction Effectiveness, 168
 - 8.13.1.1 Corrugation Control, 168
 - 8.13.1.2 Wheel Squeal, 169
 - 8.13.2 Costs versus Benefits with Respect to Wear Reduction, 169
 - 8.13.3 Site-Specific Conditions, 170
- 8.14 Rail Head Damping Inlay (AQ-FLEX), 170
- 8.15 Head Hardened, Fully Heat-Treated, and Alloy Rail, 170
- 8.16 Frictionless Rail, 170
- 8.17 References, 171

CHAPTER 8

TRACKWORK TREATMENTS

8.1 INTRODUCTION

This chapter presents a discussion of trackwork treatments for wheel/rail noise. Trackwork treatments include those treatments that would be applied directly to the track or between the rails, as distinguished from application to the structure supporting the track; in this latter case, the treatment would fall under the heading of wayside treatments. Thus, aerial structure sound barriers would not be considered a trackwork treatment. Trackwork treatments include not only materials such as rail inlays, but procedures such as rail grinding.

The principal proven trackwork treatments include rail grinding, for which an extensive discussion summarizing the basic philosophy of profile grinding and how it applies to transit systems is provided. Wayside lubrication is of particular importance for controlling wheel squeal. Continuous welded rail is effective in reducing or eliminating rail-related impact noise. Other treatments include rail joint welding, vibration damping systems, certain types of resilient fasteners and special trackwork, and hardfacing. Dry-stick lubricants are discussed with respect to onboard treatments in Chapter 7.

8.2 RAIL GRINDING

Rail grinding combined with wheel truing is the most effective and important means for controlling wheel/rail noise and maintaining track in good working condition. With ground rail and trued wheels, tangent track wheel/rail noise is comparable with the combined noise from traction motors, gears, fans, and undercar air turbulence, and is usually acceptable to wayside receivers, provided they are not located in close proximity to the track. Indeed, when complaints concerning wheel/rail noise do occur, excessively rough or corrugated rail is usually involved, producing a harsh sound with identifiable pure tones.

A case in point is provided by the Los Angeles light rail system, which received complaints concerning wayside noise from aerial structure track located about 75 ft from the nearest homes. The track was part of the new Green Line, and, although the rail was ground prior to startup and passby noise levels were within design criteria, a periodic grinding pattern was evident in the rail, and there was some residual

roughness that was not removed by the horizontal axis grinder. After grinding with a new profile grinder, wayside noise levels were reduced by about 6 dB, and members of the neighborhood expressed the opinion that the wayside noise was acceptable and no higher than that from automobile traffic passing on the boulevard between the neighborhood and residences. Thus, no extraordinary measures were needed at this location to satisfy the community. Enough cannot be said in favor of an effective rail grinding program, which must be accompanied by an equally effective wheel truing program.

8.2.1 Overview of Rail Grinding

Rail grinding is the removal of rail metal from the running surface of the rail head through the use of rotating grinding stones or wheels, or grinding blocks. The grinding stones are operated by high horsepower grinding motors mounted on rail grinding equipment, which may consist of multiple cars. Depending on size, as few as eight or as many as 120 grinding motors (and thus stones) can be mounted on the grinding equipment. Grinding blocks are mounted on special grinding cars and are simply run over the surface of the rail head at moderate vehicle speed. Most of the discussion presented below concerns rotary stone grinders.

Other grinding block systems use oscillating blocks but these have not been used to any extent in North America. They have, however, been used in Austria and other European countries.

The actual position of the grinding motor on the rail head is controlled by the angle of the grinding motor. By rotating the grinding motor with respect to the rail head, the contact band moves across the rail head. The relative position of this contact band or grinding “facet” (which is of the order of $\frac{1}{4}$ in. wide) is a function of motor angle. (Note: the relationship is not symmetrical about the rail head because of the cant of the rail.) Larger grinding facets have been observed, but accompanied by periodic grinding pattern in the facet, suggesting excessive grinding force and tool chatter. Further, using multiple, narrow facets produces a lower average roughness than would a single or double facet grinding profile.

The range of angles through which the grinding motors can rotate varies with machine type and design. Figure 8-1 illustrates three sets of angle ranges corresponding to three

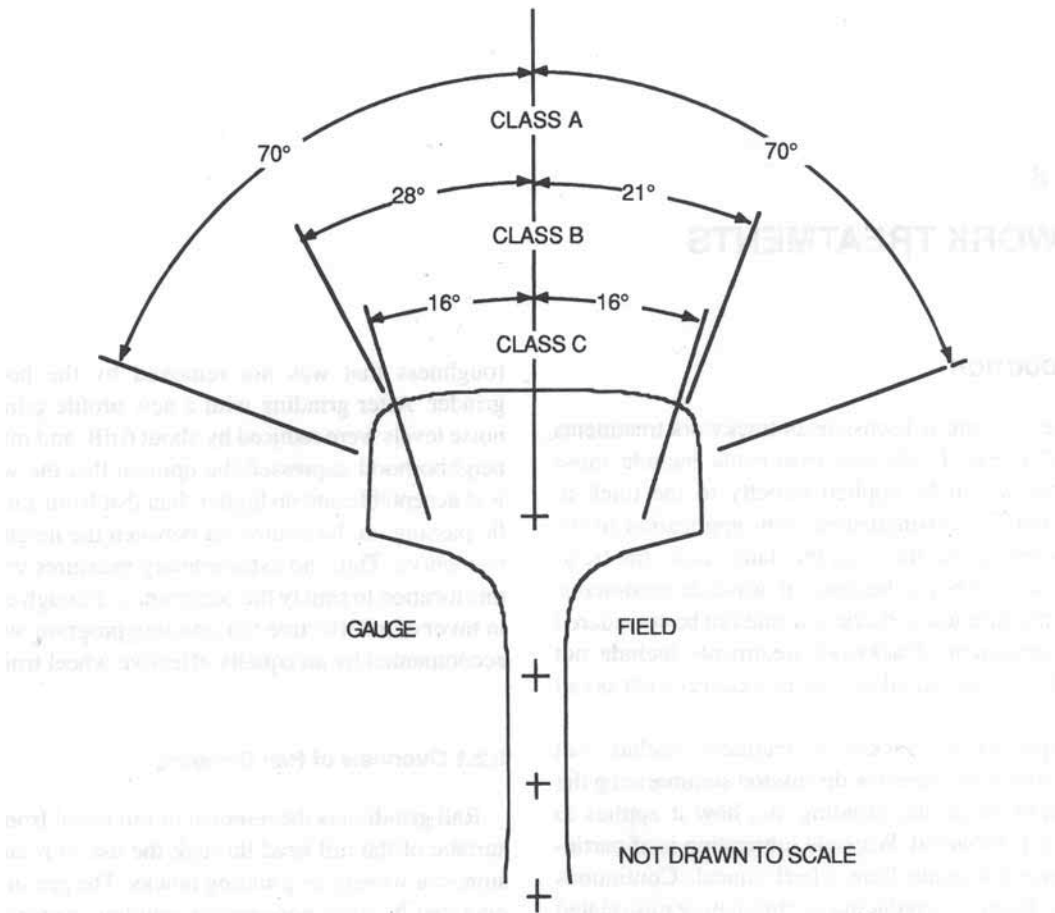

FIGURE 8-1 RANGE OF MOTOR ANGLES FOR DIFFERENT EQUIPMENT CLASSES (ZETA-TECH, INC.)

classes of grinding equipment. As can be seen from this figure, Class A has the widest range of motion and Class C, the narrowest.

Metal removal refers to the depth of metal removed by the grinding equipment in a single pass of the equipment, and is usually given in thousandths of an inch. The different factors that influence the amount of metal removed per pass by a grinding machine are

- Grinding power,
- Grinding speed,
- Power setting of individual motors,
- Location on rail head,
- Specific type of defect (for isolated defects),
- Grinding stone composition, and
- Effectiveness of grinding equipment with respect to active long wave grinding and automatic load control.

Of these parameters, the grinding power, equal to the number of grinding motors multiplied by the horsepower of the motors, is probably the most important. Figure 8-2 illustrates a direct correlation between grinding horsepower and metal

removal. The largest machines, such as the 1960 horsepower and the 2400 horsepower machines, are used primarily on heavy freight railroads. Transit and commuter rail equipment usually have a smaller number of motors, with a lower total grinding horsepower in the range of 240 to 480 horsepower.

Rail grinding has been used by freight railroads and transit systems since the late 1930s for the elimination of rail surface defects. Those early applications used relatively unsophisticated rail grinding cars for the elimination of corrugations, engine burns, and batter at rail ends. Subsequent applications of rail grinding extended rail grinding to almost all types of rail surface defects to include corrugation, joint batter, weld batter, engine burns, flaking and shelling, and the grinding of mill scale from new rail.

Traditional defect elimination or rail “rectification” remained the primary focus of rail grinding from the 1930s until the 1980s. In recent years, traditional grinding practice has evolved from the defect elimination approach to the recently emerging rail “maintenance” or “preventive” grinding approaches. The latter approach does not allow surface defects to develop to any significant extent, but rather attempts to eliminate the development of these surface

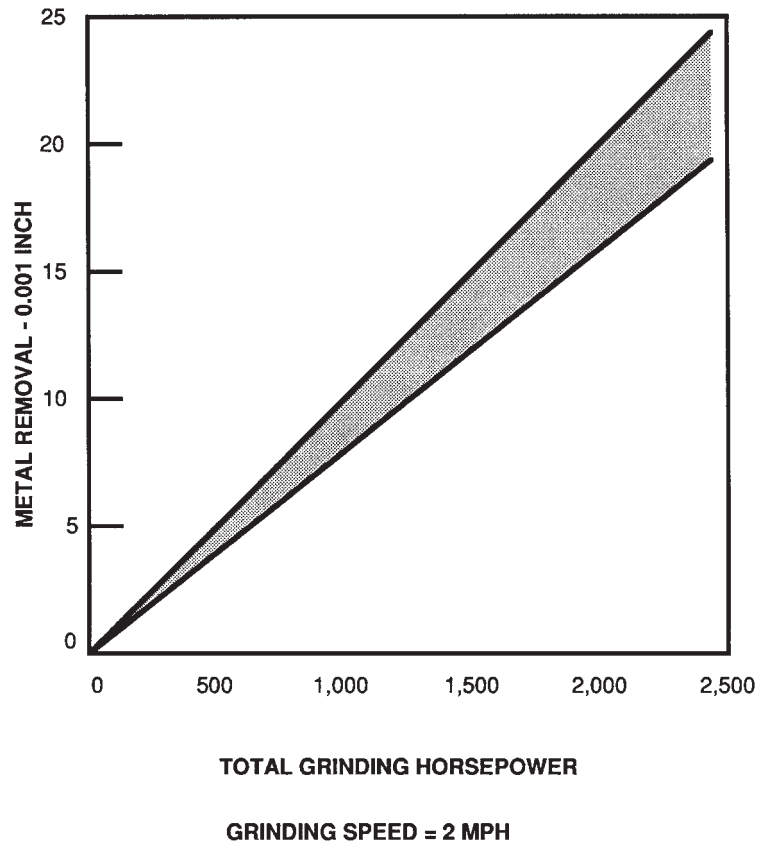

FIGURE 8-2 RELATIONSHIP BETWEEN GRINDING HORSEPOWER AND METAL REMOVAL (ZETA-TECH, INC.)

defects before they emerge on the rail head. The preventive grinding approach also makes extensive use of rail profile grinding techniques to control the shape of the rail head and the wheel/rail contact zones.

The evolution from traditional grinding to the emerging practices of profile control and maintenance grinding has resulted in a significant broadening of rail maintenance, and has introduced the potential for increasing the service life (and thus reducing the cost) of rail. Profile control and maintenance

grinding have also led to significant improvements in wheel/rail dynamic interaction and the reduction of wheel/rail forces in both the vertical and horizontal planes. This reduction in dynamic interaction (and forces) results in improved ride quality, noise reduction, and reduced damage to both the track structure and the rolling stock. Specific improvements in rail and wheel performances and lives also occur.

Rail grinding, as required by transit systems, can be divided into two broad categories, based on the specific

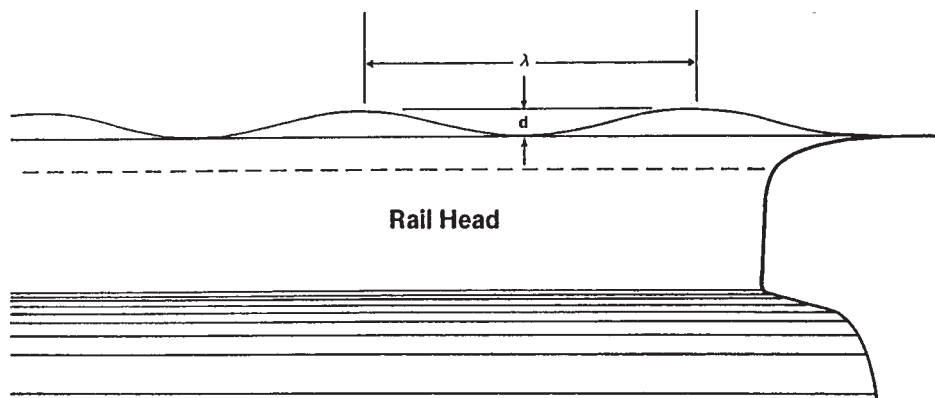

FIGURE 8-3 RAIL GRINDING WAVELENGTH

objective and method of achieving that objective. These will be described in the following sections.

8.2.1.1 Surface Defects (Level 1)

Control and/or elimination of defects on the top surface of the rail head is a traditional area of rail grinding that has direct impact on transit systems. Because these surface defects represent locations where vertical wheel/rail dynamic activity is initiated, their elimination or control results in a reduction in noise, vibration, and vertical rolling and impact forces. While defect removal grinding has traditionally been one of the remedial type actions, i.e., elimination of defects after they appear on the rail head, earlier and more aggressive grinding have led to better control of this class of defects and the consequential reduction of their adverse impact on overall operations and costs.

Surface defects normally manifest themselves on the top central area of the rail head. Thus, this type of grinding usually requires relatively limited grinding motor positioning capability and pattern adjustment. The focus of this grinding is generally the removal of metal in this top central area of the rail head as illustrated by the Class C coverage of the rail head in Figure 8-1. These surface defect grinding applications include grinding of the following classes of rail surface defects:

Corrugations. A primary focus of grinding is the removal of rail corrugations with a special emphasis on roaring rail (very short wavelength or "short pitch") corrugations with

wavelengths between 1 and 3 in. (Longer wavelengths will also require elimination, when encountered.) These corrugations will vary in depth from 0.005 in. (the smallest depth that can be measured with a traditional straight-edge and taper gauge) to 0.010 in. and greater, and they are located within a broad band at the center of the rail head (for roaring rail and long wave corrugations). In most cases, the traditional motor angle range of ± 16 degrees is adequate to remove these defects, which can extend for long lengths of track.

For corrugations with a wavelength greater than 10 in. (the diameter of the grinding wheel) a long wavelength grinding system is required to effectively reduce the amplitude of the corrugations (Figures 8-3 and 8-4). This does not appear to be a significant type of corrugation on transit systems except that long wavelength corrugations have been identified with higher speed operations. Further, long wavelength corrugations will contribute to groundborne noise and vibration, and their removal should be included in any grinding program.

Welds. Weld grinding reduces wheel/rail impact noise and helps to control corrugation. Welds are ground either to remove high/low welds from the welding plant (see new rail) or to remove batter that occurs at the surface of the weld, generally at or near the fusion zone or the heat-affected zone of the weld. This occurs frequently near field welds, where the surface hardness can vary significantly from the parent metal, through the heat-affected zones and fusion zones. The depth of the batter can range from 0.005 in. to over 0.050 in., and its length from several inches to 36 in. (the standard length for measuring joints or welds). Note: a long wavelength grinding feature may be required to effectively grind this class of defects. Battered welds can extend (transversely) across the top of the rail head; however, they can normally be covered by a motor angle range of ± 16 degrees.

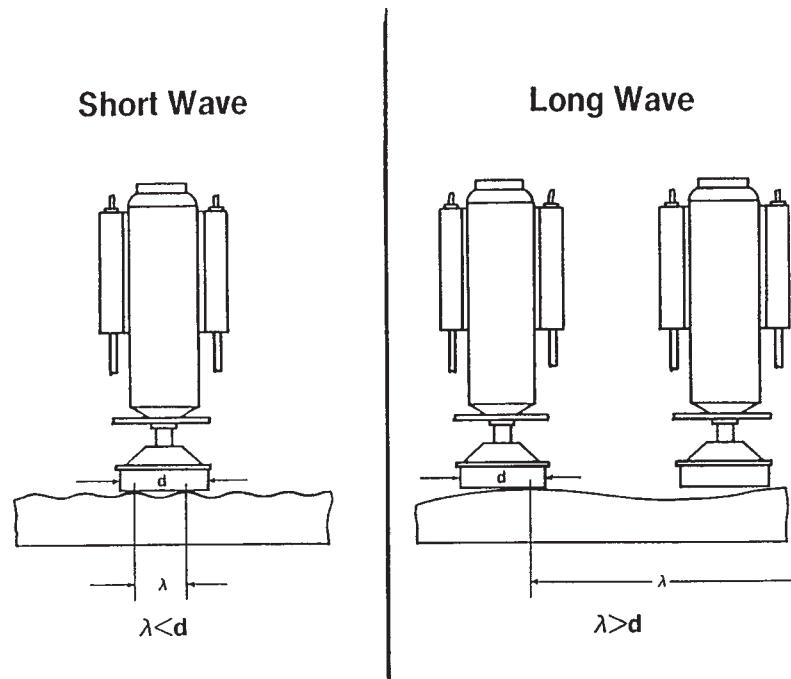

FIGURE 8-4 EFFECT OF LONG WAVELENGTH CORRUGATION ON RAIL GRINDING

Battered Joints. While joints are not a significant problem on transit systems (they are usually replaced by field welds), they do exist and they should be monitored for batter. Joint batter, which may contribute to unnecessary impact noise due to excessive gap and/or misalignment, is traditionally measured over a 36 in. length (18 in. on either side of the joint), and, as such, it has a long wavelength character, thus requiring a long wavelength grinding system for effective grinding. Joint batter can range from 0.010 to 0.250 in., although grinding out joint batter deeper than 0.050 to 0.060 in. is generally uneconomical. (Repair by welding is usually required for greater depths.) Battered joints usually extend across the top of the rail head, but they can normally be covered by a motor angle range of ± 16 degrees.

Wheel Burns. Wheel burns may contribute to excessive impact noise. Wheel burns are not a major concern on transit systems, but they should be removed from the surface of the rail head. Wheel burns range in depth from 0.010 to 0.250 in., but grinding out wheel burns deeper than 0.050 in. is generally uneconomical. (Repair by welding is usually required for greater depths.) Wheel burns are normally found on the top central area of the rail head, and are normally covered by a ± 16 degree motor angle range. A related problem concerns imperfections in the rail running surface due to repeated stopping of wheels at the same location, which may be exacerbated by automated train control systems and friction brake application at the end of deceleration.

New Rail. New rail is usually ground within the first several months of installation to remove rail surface mill scale, rail surface roughness, surface blemishes, and high/low welds from the welding plant. Mill scale is a very fine layer on the surface of the rail head, less than 0.010 in depth, and is usually removed by a light grinding pass. Rail welds are generally high (most railroad welding plant standards try to eliminate low welds, and consequently accept high welds), usually 0.005 to 0.020 in., and therefore rail grinding is very effective in their elimination.

Block grinding as practiced by the CTA and TTC involve moderate speed grinding passes with abrasive blocks. Relatively little material is removed with each pass, thus requiring multiple passes. An advantage of block grinding is that grinding trains may be interspersed between revenue service trains. The disadvantage of block grinders is that rail profile is not maintained, and a large number of passes may be required to remove even minor surface defects.

Horizontal axis grinders employ a grinding stone positioned so that the edge of the grinding stone contacts the rail. This type of grinder cannot grind a profile into the rail head as can a vertical axis grinder, though it can remove surface defects.

8.2.1.2 Profile Grinding (Level 2)

Rail profile grinding refers to the method of controlling and maintaining the shape of the rail head (hence the term "profile") by grinding the head of the rail. Profile grinding

goes beyond the basic defect removal approach of conventional grinding and addresses the control of the shape of the rail and the associated interaction between the wheel and the rail. Profile grinding is relatively new to transit properties, being done only at a few, such as Vancouver, MARTA (I) and Los Angeles. The MBTA has recently completed profile grinding on much of the Blue and Green Lines, with clearly positive results. Thus, profile grinding has not had extensive review with respect to noise control at U.S. transit systems, but it is gaining in popularity.

Shaping the rail head and influencing wheel/rail interaction are major differences between simple defect removal and profile grinding approaches. Traditional defect elimination grinding tends to flatten the rail, while profile grinding grinds a specific contour or profile into the rail head. (Contour grinding is used to restore the original shape or profile of the rail head, while profile grinding is used to give the rail head a special profile other than its original rail profile.) Through control of the rail head shape, the locations of wheel/rail contact, and thus the interaction between the wheels and the rail head, can be controlled. Profile grinding has a substantial influence on ride quality, by controlling truck hunting. Profile grinding has been used at the Vancouver Skytrain as a noise reduction feature to reduce wheel/rail conformity and spin-slip, resulting in lower rail wear and corrugation rates, and lower noise due to both rail surface degradation and spin-slip. Kalousek has suggested that spin-slip contributes to wayside noise, even without significant wear or corrugation (2).

Elimination of surface defects, if present, is the necessary first step in profile grinding. Thus, for rail with surface defects and plastic flow, profile grinding can be a three-step process:

- 1) The initial step consists of one or more grinding passes which eliminate any surface defects present.
- 2) The second step consists of one or more grinding passes which effectively reshape the deformed rail head.
- 3) The third and final step (if necessary) grinds the final rail head profile.

8.2.1.2.1 Grinding at Curves

Rail profile grinding at curved track, as is currently practiced in North America, encompasses three general areas of rail maintenance:

- Control of gauge face wear (and lateral wheel/rail curving) of the high rail on curves and on tangents (as applicable).
- Control of short wave corrugations, on the low rail on curves.
- Control of gauge corner surface fatigue, to include both spalling and shelling, on the high rail on curves.

While all three purposes can be achieved through the proper use of rail profile grinding, they generally cannot all be addressed simultaneously. Thus, the profile that is best suited for the control of one of these maintenance areas may not be the best for the other two problem areas, even though it may be possible to derive benefit in all three areas by proper profile selection. Therefore, prioritizing rail problems for a given track location and selecting the optimum rail head profile for that problem location is necessary to get the greatest benefit from profile grinding.

The use of rail profile grinding to control wheel/rail interaction, wheel/rail contact, and (thus) rail wear at curves was developed and introduced by the mining railroads of Western Australia during the late 1970s. The focus of this research and subsequent implementation was the reduction of gauge face wear of rail on low and moderate curvature track, through the optimization of the “steering” of conventional three-piece freight car trucks. The results were the development of a set of asymmetric rail head profiles (i.e., asymmetric about the center line of the rail head), with a separate profile for the high and low rails of the same curve. In addition, for tangent track, where “hunting” wear was noted, special tangent profiles were developed to control this form of wheel/rail behavior, and the resulting rail head wear.

The initial profile grinding concept was designed to make use of the steering of the conventional three-piece freight car truck generated by the conicity of the wheelset. This generates a shifting of the wheelset (“outward”) toward the outer or high rail of the curve, resulting in the outer wheel riding on the larger radius portion of its tread, and the inner wheel riding on the smaller radius portion of its tread. The difference between these radii, known as the “rolling radius dif-

ferential,” compensates for the difference in length, around the curve, between the high and low rails. In addition, this rolling radius differential generates a longitudinal creep force (which is, in fact, a partial wheel slippage in the longitudinal direction) which tends to align the axles into a radial position (with equally distributed misalignment of the two axles). The result of this is a degree of self-steering that reduces flanging on relatively shallow curves, and has the potential for eliminating flanging on curves less than 3 degrees (based on a 1:20 wheel conicity). This has a beneficial effect in reducing lateral creep and thus wheel squeal at curves. (Note: the effect of this self-steering is reduced when the conicity of the wheel set is reduced (i.e., for 1:40 wheels). (Systems such as BART and Chicago CTA which employ cylindrical wheels cannot benefit from this self-steering effect. Further, systems that do not true wheels sufficiently and have concave wheel tread profiles may not benefit from this self-steering effect.)

In order to maximize this rolling radius differential, and still maintain sufficient wheel/rail contact area to avoid excessive contact stresses, the profiling approach presented in Figure 8-5 was developed. This profile shifts the wheel/rail contact patch on the high rail toward the gauge side of the rail head. On the low rail, the contact zone is moved toward the field side of the rail head. In this manner the rolling radius differential is emphasized, and lateral forces generated by the three-piece truck while curving are reduced. As a direct result, lateral gauge face wear is also reduced.

Profile grinding to modify contact patch location and increase rolling radius differential is in a sense similar to gauge widening, but does not actually affect the gauge. Contact patch shifting may be considered by some to be preferable to gauge widening. Gauge widening will reduce wheel

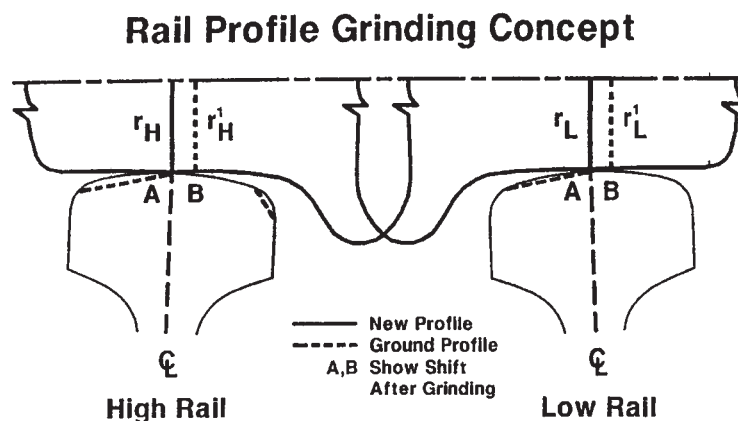

Ground Contours of High and Low Rails Shift Point of Wheel Contact from A to B, Increasing Differential Rolling Radius to an Extent Making Wheelset Self-Steering on Curves Up to Somewhat Over Two Degrees of Curvature. Gauge Corner of High Rail is also Relieved Slightly to Avoid Contact with Flange Throat.

FIGURE 8-5 PROFILE GRINDING TO IMPROVE CAR STEERING

squeal for conically profiled wheel treads, by allowing the axle set to position itself such that the circumference of surface contact on the field side is larger than the contact line circumference on the gauge side. Tight gauge would force the contact patch locations close to the fillets of the flanges, limiting the ability of the wheel set to effect differential wheel rotation. However, tight gauge would introduce other problems, such as excessive flange and gauge face wear, since the truck must necessarily travel through the curve, with axles not perpendicular to the rail, so that tight gauge should not be a part of normal track design. Excessive gauge widening at short radius curves, however, will promote truck crabbing, and thus severe angle of attack and resulting flange wear, evidenced by a sharp gauge corner. Squeal also accompanies this type of curving performance, though it is not clear if the squeal is due to flange and gauge face rubbing, lateral creep, or both. There are some transit engineers who suggest that gauge widening is not desirable at curves because of increased lateral slip, provided that a tight gauge condition does not occur, and some have suggested that gauge widening is a hold-over from steam locomotive railroading days when very long wheel bases were involved. Thus, asymmetrical profile grinding to effect rolling radius differential appears to be preferable to gauge widening at curves. (However, see the discussion in this chapter concerning gauge widening.)

Rail profiles deteriorate with traffic. In one set of tests, the profiles lasted only 10 MGT (in non-lubricated heavy axle load freight operations) and were completely gone after 20 MGT of traffic. Profile life can be extended with head hardened, fully heat treated, or alloy rail. Further, rail profile life will be longer with light-axle-load rail transit vehicles than with heavy-axle-load freight. However, rapid gauge face wear occurs at light rail short radius curves, and may require reprofiling on a relatively frequent basis. Reducing crab angle to a minimum and preventing flanging by maintaining standard gauge throughout the curve may alleviate this problem if a tight gauge condition can be avoided.

8.2.1.2.2 Control of Corrugations

A second area where benefit has been derived from profile grinding is in the area of corrugation control at curves. In the case of North American applications, this refers to the control of the heavy-axle-load short-wavelength corrugations found on the low rail of curves. These corrugations generally have *wavelengths in the range of 12 to 24 in.* on wood tie track. This is not usually the case for the roaring rail or short-pitch corrugations at transit systems, where the wavelength range is between 1 and 4 in.

These freight railroad corrugations are generally associated with high contact stresses generated when the false flange of a worn wheel runs on the field side of the low rail. This contact, which is counter-formal (i.e., the curvature of the two bodies in contact are opposite to each other), causes

significantly higher wheel/rail contact stresses than the other (conformal) wheel/rail contact configurations. When this high contact stress is located near the field side of the low rail, severe plastic deformations and corresponding short wavelength corrugations can result.

Profile grinding has been used to control these short wavelength (“freight”) corrugations on North American freight railroads. By grinding the field side of the low rail to shift the contact point toward the center of the rail head, the high stress producing false flange contact is avoided. In recent tests on North American freight railroads, profile grinding to control the regrowth of corrugations was found to be significantly more effective in slowing regrowth of corrugation than conventional (defect elimination) grinding patterns. However, while this technique has been shown to be effective for control of freight type corrugations, there is no real evidence of its use or benefits for the control of corrugations typical of transit or passenger (high speed, lighter axle load) operations.

Again, the short wave freight corrugations referred to here differ in appearance (wavelength and amplitude distribution), and, perhaps, in initiation mechanism, from the roaring rail or short pitch class of corrugations most commonly associated with transit and passenger operations. (Control of short pitch corrugation via rail grinding is discussed in Chapter 10 to this report.)

A 16-stone profile grinder is preferable to an 8-stone profile grinder for grinding corrugations, due to the metal removal required. Production grinding to remove corrugations may require 20 passes with an 8-stone grinder, while a 16-stone grinder can accomplish the task in one-half the time (3).

8.2.1.2.3 Control of Gauge Corner Fatigue

The third area of benefit associated with rail profile grinding is in the control of rail surface fatigue, and in particular fatigue defects at the gauge corner of the rail head. This includes both surface fatigue defects, such as spalling, and subsurface fatigue defects, such as gauge corner shelling, commonly found on heavy axle load freight operations. In a severe flanging condition, such as at a sharp curve, single-point contact between the throat of the wheel and the gauge corner of the rail will frequently result. *In the case of heavy-axle-load freight traffic*, this type of contact generates very high contact stresses in the region of the gauge corner of the high rail. These high stresses can result in gauge corner fatigue problems, including cracking and spalling.

To relieve these high contact stresses, grinding of the gauge corner of the rail can shift the wheel/rail contact points away from this corner and into a more central location on the rail head. The grinding required to shift this contact away from the gauge corner requires grinding on the gauge corner of the high rail. This grinding of the gauge corner can result in a decrease in both surface fatigue spalling and subsurface fatigue shelling, by wearing away the surface fatigue dam-

aged rail steel, and relocating the point of maximum rail stress before fatigue damage can initiate a failure defect.

In the case of sharper curves, where flanging takes place, a second contact point between the flange of the wheel and the gauge face of the rail can occur, thus generating “two-point” contact between the wheel and the rail. This change in wheel rail contact, from one-point to two-point contact, can result in a deterioration in truck curving performance, and a corresponding increase in wheel/rail flanging forces. The result of this can be an increase in gauge face wear and, perhaps, noise, if no other action is taken. *Therefore, this type of gauge corner profile grinding should be used primarily in those areas where rail fatigue and not rail wear is the dominant rail failure mode.*

Single-point contact will result in the most efficient curving performance of the wheelsets and the lowest level of lateral wheel rail forces. Reduced wheel squeal might also be a possible benefit, though this has not been demonstrated. Thus, in the case of light-axle-load passenger operations, such as with transit systems, where fatigue failure at the gauge corner is not a problem, but rail and wheel wear is of primary import, *profile grinding for fatigue control through the initiation of two-point contact should be avoided.*

8.2.1.2.4 Tangent Track

Reducing wheel/rail conformity by profile grinding can reduce corrugation growth rates on tangent track. Reduction of conformal contact across the rail head reduces the tendency for spin-slip behavior. Conversely, increasing conformal contact may average rail roughness over the contact patch, thus reducing the effective rail roughness (4). These are two conflicting arguments that need to be resolved. For the present, reducing conformal contact across the rail head appears to be most desirable from the standpoint of reducing rail corrugation rate.

Profile grinding is also used to control wheel wear, or rutting. The Vancouver Skytrain employs contour grinding to vary the contact patch location from one section of track to another, thus spreading the wear on the wheel surface. This results in lessened wheel/rail conformity which would otherwise result because of wheel wear. The LACMTA is using similar procedures on the Blue Line and Green Line.

8.2.1.2.5 Noise Reduction Effectiveness

Rail grinding affects two causes of wheel/rail noise: (1) rail roughness due to surface defects and general surface roughness and (2) rail corrugation. General surfacing of the rail by grinding reduces the random roughness produced by general wear, and measurable broad band noise reductions may be obtained by reducing this roughness. For example, measurements at SEPTA (5) indicated that rail grinding produced small but consistent noise reductions on tangent track, limited by propulsion system noise, and little or no reduction

of squeal noise at curved track. Rail grinding at continuous welded rail sections produced 0 to 2 dBA noise reduction at the wayside. However, there was little evidence of corrugation, pitting, or spalling which would be removed by grinding. Corrugation induced noise is one of the most severe forms of wheel/rail noise. Figure 8-6 compares noise levels for different rail corrugation depths and wavelengths with noise levels for uncorrugated rail. Even low corrugation amplitudes of 0.002 in. are capable of producing the characteristic roaring rail or wheel/rail howl, roughly 10 dB higher than noise levels for smooth ground rail (6).

Corrugated rail noise may be exacerbated by loss of contact between the wheel and rail, producing chatter and an irritating howling sound. The literature suggests that loss of contact occurs on high-speed systems when the corrugation depth exceeds about 40 microns, or about 0.0016 in., peak to valley. At lower speeds, greater corrugation amplitudes would be required to induce contact separation. These magnitudes are supported by rough calculations. For example, if an 800-lb wheel is displaced at a zero-to-peak amplitude of 0.001 in. at 500 Hz, the resulting acceleration of the wheel is about 25 g, and the reaction force of the wheel is roughly 20,000 lb, twice the static load for a typical transit vehicle wheel. Looking in the other direction, only 3.5 mil displacement of a 1-yd length of 115-lb rail at a frequency of 500 Hz would produce a dynamic load of 10,000 lb, comparable with the static contact load. These numbers are controlled by contact stiffness, rail bending stiffness, and masses, but their order-of-magnitudes indicate that small corrugation amplitudes are sufficient to overcome contact static load. Further, they are consistent with the evidence for the (nonlinear) relationship between noise level differences for corrugated rails with amplitudes of 0.002 and 0.004 in. and uncorrugated rail shown in Figure 8-6.

One might expect that corrugation rates would be highest when dynamic wheel/rail contact forces approach or exceed the static contact force. At low vertical contact force, lateral creep and abrasive wear of the rail surface may occur. Contact separation might also contribute to plastic flow and differential periodic work hardening. *Thus, the problem of maintaining wheel/rail contact and controlling corrugation rate is greater with transit vehicle wheel/rail static contact loads of 10,000 lb than for heavy haul freight wheel/rail contact loads of perhaps 25,000 to 30,000 lb. Rail grinding is thus more critical and necessary on a transit system than on a heavy haul freight system to control corrugation.*

Regardless of whether or not contact separation occurs, rail corrugation produces unnecessarily high and objectionable noise levels both at the wayside and inside the vehicle. The noise reduction achievable with rail grinding depends, of course, on the degree of wear and corrugation existing prior to rail grinding.

BART. BART is concerned about vehicle interior noise during passage through tunnels, specifically the Transbay Tube, and with wayside community noise. The rails in the Transbay Tube are subject to corrugation, with depths on the

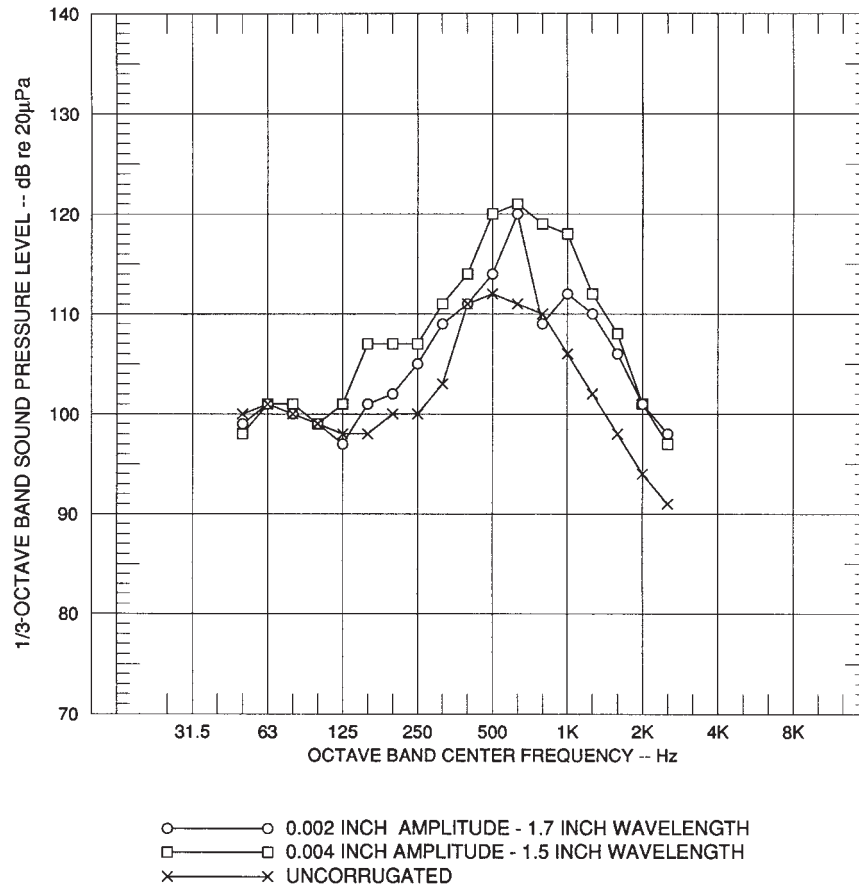

FIGURE 8-6 EFFECT OF CORRUGATION AMPLITUDE ON WHEEL/RAIL NOISE

order of 0.010 in. (questionnaire return) (7). Grinding frequency is low because of low track availability. Other subway sections are in similar condition. BART has made great progress recently in grinding sections of track, enabled in part by purchase of a Pandrol-Jackson grinder that can travel to and from grinding sites at reasonable speed, thus maximizing grinding time during nonrevenue hours.

Figure 8-7 illustrates the noise reduction at corrugated BART ballast-and-tie track due to rail grinding at Level 1, that is, grinding to remove corrugations. In this example, a very pronounced peak occurs in the 1/3-octave band spectrum at 500 Hz, which, coincidentally, corresponds to a wheelset resonance frequency. After rail grinding, the discrete frequency component was reduced by about 13 dB, resulting in a much smoother spectrum, without the harshness normally associated with corrugated rail. The A-weighted levels were reduced from about 98 dBA to about 79 dBA. With the elimination of the harsh sound due to the peak at 500 Hz, the qualitative effect of rail grinding is considerably greater than indicated simply on the basis of A-weighted noise reductions.

A second example of rail grinding effectiveness at a BART concrete aerial structure is provided in Figure 8-8. As at the ballast-and-tie section, the corrugation produced a sub-

stantial pure tone concentrated at the 500 Hz octave band. The grinding removed the corrugation, but introduced a short pitch roughness which produced a peak in the noise spectrum at about 800 Hz. An inspection by this author of BART's rails indicates a short wave periodic pattern on the rail head, which would produce the discrete frequency component at high frequencies for moderate train speeds. The pattern appears to be produced by the grinding operation, which includes grinding two large, 7/8- to 1-in. wide facets to remove surface defects, and then grinding a 45-degree bevel at either side of the rail head. Thus, no radius is provided at the rail head, relying, instead, on subsequent wear to improve the rail head profile. Further, the contact patch boundary may easily coincide with the edge between the bevel and the ground running surface. Where the 45-degree bevel is not used, the field side of the wear strip may run onto unground portions of the rail, and the edge of the strip may be irregular. Scratch marks and regular waves produced by tool chatter and debris accumulation by the grinding stone are identified as possible causes of whistling rail, though grinding induced noise is believed to be reduced to some extent by wear. SPENO is taking steps to identify and reduce or eliminate the cause of post-rail grinding whistle (8).

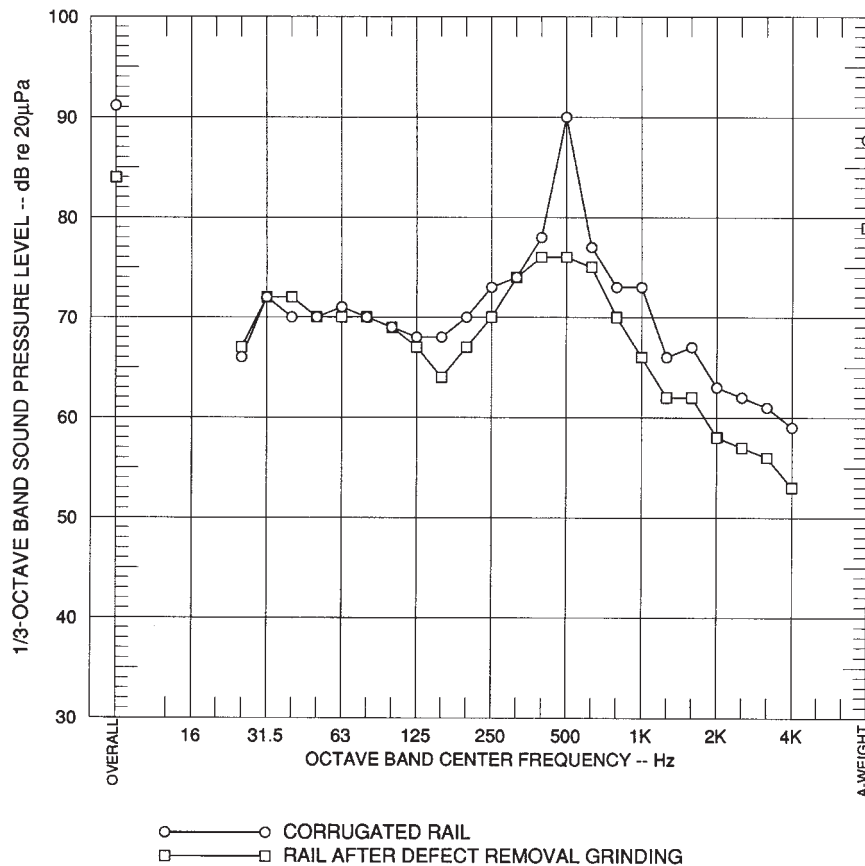

FIGURE 8-7 WAYSIDE NOISE FROM BALLAST-AND-TIE TRACK BEFORE AND AFTER DEFECT REMOVAL GRINDING

Shinkansen (Japan). A periodic wave introduced by rail grinding is reported for the Shinkansen system in Japan (9). The wavelength appears to be about 1.3 in., similar in length to that at BART. Trains traveling at about 70 mph over this grinding wavelength would produce a discrete frequency component at about 1,000 Hz, also similar to the frequency component obtained at BART. Rail grinding at the Shinkansen line is done with SPENO grinding cars with rotary stones with 6 or 8 heads. Rail head defects are corrected as soon as discovered with a grinding machine which can treat 2 to 3 m of rail in one operation. Mainline sections of track are ground at 12- to 24-month intervals, and rails in noise sensitive areas are ground twice per year. Material removal is about 0.03 mm, or about 1 mil, per grinding pass. The grinder makes 3 to 5 round trips on the same section of rail, removing a total of about 0.3 to 0.5 mm, or about 10 to 20 mils. Projecting ahead for a 6-month grinding interval in noise sensitive areas, the grinding operations would evidently remove about 0.4 in. of rail in 10 years.

However, wayside noise levels at the Shinkansen increase at about 2 dBA per year, requiring removal of only about 50 µm, or 1.3 µin., every 12 months to maintain optimally low wayside noise. (Wayside wheel/rail noise levels at 25 m from the Shinkansen track for 230-km/hr trains are indicated to be about 65 to 66 dBA on ballast-and-tie track and 68 to

69 dBA on slab track, with a 2-m sound barrier wall and 60 kg/m rail. These noise levels are surprisingly low considering the speeds involved. The environmental noise limit standard is 75 dBA.) Rail welds are carefully ground to remove imperfections and thus impact noise (10).

Portland Tri-Met. Tri-Met has recently ground entire sections of track to reduce wayside noise levels due to corrugation. Specific areas of concern include ballast-and-tie sections where train speeds of 55 mph occur. Grinding was performed with a LORAM grinding machine with horizontal axis grinding stones, which remove corrugation and rail defects, but do not profile the rail head. Wayside noise levels were on the order of 90 dBA at 50 ft from the track center before rail grinding, and were reduced to about 80 dBA after grinding. However, a little over a year after grinding, noise levels increased to about 86 to 87 dBA, with re-emergent visible corrugation. Only a limited amount of material was removed, so that work hardening may not have been ground out. The only other prior grinding was before startup in the 1980s.

MARTA. MARTA is engaged in an "aggressive" rail profile grinding program. MARTA recently purchased a Fair-

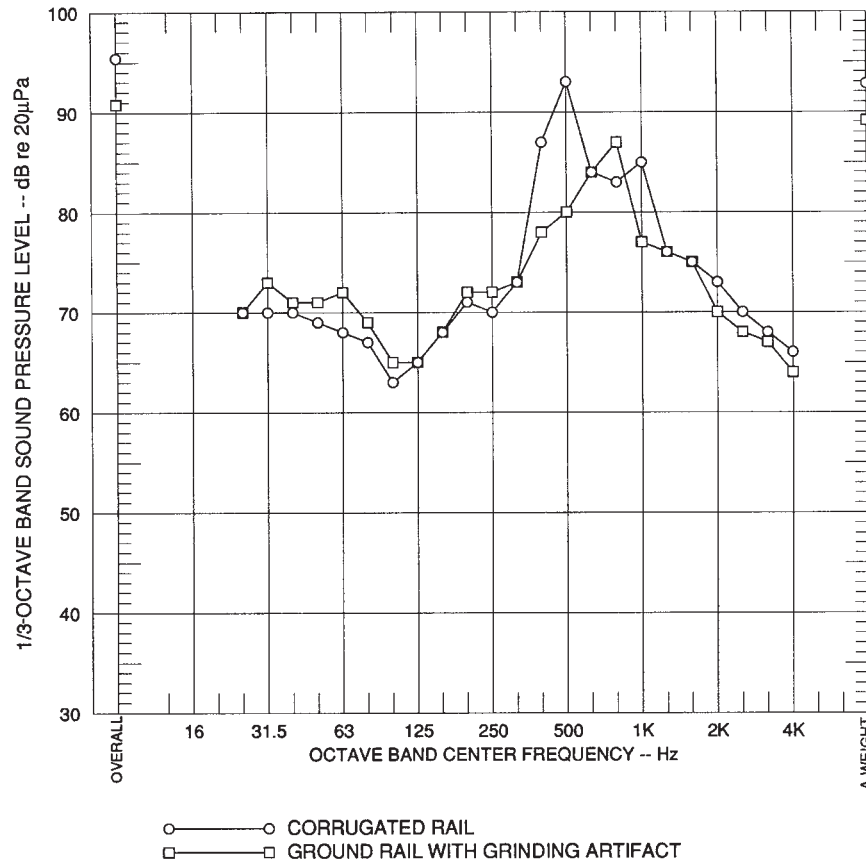

FIGURE 8-8 EFFECT OF GRINDING ARTIFACT ON WAYSIDE NOISE AT 50 FEET FROM CONCRETE AERIAL STRUCTURE WITH DIRECT FIXATION FASTENERS

mont RGH8 grinder with eight 20-horsepower hydraulic grinding motors. Grinding axes can be set and controlled from the operator's console, and a computer can be used to set up to 99 grinding profiles. Six-inch stones are used for turnouts and 10 stones are used for tangent track. Grinding is done at 80% of maximum horsepower for regular grinding, and 40% of maximum horsepower for polishing or finishing work. MARTA intends to remove about 0.002 in. of material from tangent track rails on a yearly basis. Material removal at turnouts is on the order of 0.005 in. per pass at the rail head and 0.015 in. per pass at the gauge corner. Grinding is performed to achieve total relief of the gauge and field corners and maintain a contact patch width of 1 to 1.5 in. MARTA can evidently maintain rail in good condition with relatively limited grinding of tangent track, no doubt because of its grinding program employed since startup. MARTA's first grinding was performed before revenue service to remove mill scale, rust, and minor mill defects. Subsequently, MARTA contracted to have about 0.002 inch ground off on an annual basis, though no profiling was performed. In 1987, MARTA experienced problems with spalling, and engaged in profile grinding with excellent results, and profile grinding has been employed ever since. As a result of MARTA's grinding pro-

gram, rail corrugation has not emerged, even on direct fixation track where corrugation is often experienced, such as at BART. MARTA's continual attention to rail maintenance clearly illustrates the benefit in preventing rail corrugation and, by extension, excessive noise (11).

WMATA. WMATA grinds rail on an annual basis or whenever corrugation depths reach 0.010 in. (survey questionnaire). Discussions with one of the engineering staff at WMATA indicate that rail corrugation has not been a serious problem at most of the WMATA system. WMATA owns a LORAM horizontal axis grinder. Defect removal rail grinding appears to be effective in controlling rail degradation and wear, even though the rail is not re-profiled.

TTC. The Toronto Transit Commission regularly grinds with block grinders at 6-week intervals (survey questionnaire). Grinding operations are performed at heavy rail subway sections, embedded light rail track, and the Scarborough automated guideway system. Rail corrugation is evidently under control.

CTA. The Chicago CTA employs block grinding techniques between revenue trains. Block grinders are reputed to

provide the smoothest of rail surfaces, and thus the lowest noise, compared with rotary stone grinders (12). However, block grinders are incapable of profiling the rail, and grinding must be conducted often, though grinding may be performed at high speed.

LACMTA. The Los Angeles County Metropolitan Transit Authority has recently procured a Fairmont Tamper profile grinding machine. Noise reductions achieved with the new grinding at the Blue Line were 12 dB on rail that had been ground within the 3 years prior to profile grinding. Noise reductions of about 6 dB were obtained at the Green Line at a location where vigorous community reaction was experienced as a consequence of a pure tone in the wayside noise spectrum, even though the rail had been ground prior to start-up by a horizontal axis grinder. The community complaints were received immediately after start-up, in spite of the fact that wayside noise levels were within the design criteria, and in spite of the presence of an active railroad and a 4-lane boulevard between the residences and the Green Line. After profile grinding, the residents indicate that the noise is no higher than the local automobile traffic and acceptable. This is a success story that should not be minimized, since additional and relatively expensive site specific treatments were being considered prior to profile grinding.

8.2.1.3 Rail Grinders

Following below are examples of commercial rail grinding manufacturers.

LORAM. The LORAM Rotra grinder is a grinder (LR Series) with horizontal axis rotary stones, capable of removing surface defects and corrugation, but incapable of profile grinding. LORAM also provides vertical axis grinders capable of profile grinding. The LORAM LR grinder can grind short radius curves and embedded track, which is particularly useful at light rail systems such as Tri-Met, LA Blue Line, and others. (Loram Maintenance of Way, Inc., Hamel, MN 55340)

Pandrol-Jackson: Production Transit Grinder. This is a vertical axis rotary stone grinding train capable of removing both rail defects, corrugations, and reprofiling, and is capable of grinding switches and frogs. The grinding train consist may be configured with between 8 and 24 stones. Up to 7 transverse profiles can be ground under computer control. Computerized longitudinal and transverse profile measuring systems are provided, with the ability to overlay transverse profiles with desired grinding profiles. Wavelengths up to roughly 6 ft can be removed, which is particularly important for groundborne noise and vibration control. The grinder can travel to the grinding site at 50 mph on certain grades. Pandrol-Jackson also offers a software package called Graphical Grinding Plan Software (Pandrol-Jackson, Inc., Hoffman Estates, IL 60195).

Fairmont Tamper. Fairmont Tamper offers a variety of grinders. The Model RGH8 (used by MARTA) is called a Precision Maintenance Grinder, which restores rail head profiles and grinds switches, turnouts, grade crossings, and other areas not ground by larger grinders. The grinding speed is 6.5 mph. The grinder has 8 independently positioned stones. A second grinder may be connected to form a 16-stone grinder operated by a single person, which reduces the grinding time required to remove a certain amount of metal. Options include embedded track capability, pattern storage and retrieval for up to 99 patterns, and a "rail corrugation recorder system" that displays grinding data before and after grinding. (Fairmont Tamper, Cayce-West Columbia, SC 29171-0020)

SEPTA has developed a split truck design for negotiation of curves with radii as low as 33 ft in transit, though its minimum curve radius grinding capability has not been determined (13).

8.2.1.4 Economics of Rail Grinding

A primary benefit associated with increased grinding is a significant reduction in the rate of wear of the rails in track. This benefit is due to profile grinding which controls the steering of the wheelset around a curve. Improving wheel/rail contact geometry and steering can significantly reduce rail (and also wheel) wear. A second benefit is also associated with the reduction and/or elimination of rail surface defects such as corrugations, pits, spalls, battered welds, etc. These defects have the effect of reducing rail life, particularly if they get so deep that they can not be removed. Defects cause excessive wayside and interior noise, and excessive vibration of the trucks and truck mounted equipment. While profile grinding can be used to reduce these defects, they can also be removed by conventional "defect" grinding techniques.

Additional benefits associated with profile grinding include a reduction in wheel wear rate which is commensurate with a reduction of rail wear rate. In addition, elimination of corrugations and surface defects will provide benefits in the area of surfacing, energy (fuel) consumption, and maintenance. These latter benefits are associated with the reduction in wheel/rail vibration and impact associated with the elimination of rail surface defects.

The analysis presented here is for the economics of conventional (defect) grinding for the elimination of rail surface defects (corrugations, etc.) only. For the purpose of this economic analysis, grinding will be accomplished through the use of conventional grinding machines such as a 20-motor, fully adjustable self-propelled grinding machine of the type being increasingly used in transit environments. The analysis is conservative, since it will compare *no grinding* to two levels of grinding: conventional (defect) grinding and profile grinding (which also includes reduction in wear of the rail and wheel). The analysis is based on that performed previously for a major transit system (SEPTA).

For the purpose of this analysis, three levels of grinding will be analyzed:

- Level 0: No Grinding
- Level 1: Defect Grinding: Elimination of corrugations and other surface defects
- Level 2: Profile Grinding: Control of wheel/rail contact and wear as well as surface defects (thus this includes benefits beyond that associated with corrugation elimination).

The analysis performed was on 79 mi of curved track on a large transit system which was analyzed as a function of traffic density ranging from under 1 MGT per year (corresponding to less than 200 cars per week) to a maximum of 7 MGT per year (corresponding to several thousand cars per week). The average density is approximately 3.5 MGT (or approximately 1000 cars per week).

Based on the above densities, and a detailed breakdown of curvature, the following annual rail replacement needs were determined for the curved track on the system. (Note: tangent track was *not* considered in this analysis since grinding will not significantly affect the rate of replacement of tangent track, except where tangent track noise due to corrugations and surface defects is a factor. Thus, the analysis presented here is conservative and *underestimates* the savings associated with rail grinding on tangent track where corrugations or other surface defects are present. The rail replacement requirements presented here are not the full system requirements but rather the curve requirements only.)

The following analysis assumes a low to moderate level of lubrication on these curves.

Annual Curve Rail Replacement Requirements; Curve Only Division: (total standard and premium rail)

- Grinding Level 0: 3.3 mi
- Grinding Level 1: 2.3 mi
- Grinding Level 2: 1.8 mi

Thus, a conventional (defect) grinding program can save approximately 1 mi of rail per year, and a profile grinding program can save 1.5 mi of replacement rail each year.

Converting these mileages into costs: for a conventional level of grinding, rail only savings, amount to annual savings of approximately \$240,000. For profile grinding, savings associated with rail only, amount to approximately \$370,000 per year. (Note: these savings do not include any wheel cost savings, surfacing savings, or fuel (energy) savings.) If only a moderate level of wheel life extension is claimed for profile grinding (a very conservative set of values), then savings of between \$155,000 and \$290,000 per year could be

achieved, based on the level and extent of grinding. Additional savings, associated with a reduction in vibration and impact to the track, translates into reduced surfacing requirements on the corrugated track (or track with other surface defects). Likewise, elimination of surface defects reduces the energy loss in the truck suspension system associated with the vibrations induced by these surface defects. Reduction of vibration of trucks and truck mounted equipment may reduce maintenance requirements and equipment failures. The costs (and thus savings) associated with these areas depend on the level of severity of the surface defects. Analysis of two levels, moderate surface defects and severe surface defects, generates savings as shown in Table 8-1. Thus, total savings could range between \$400,000 and \$650,000 per year. To this, one must add the non-monetary benefit of reducing wheel/rail noise impacts on the community and transit patrons.

Note that grinding costs and savings vary by type of grinder, local labor rates, materials, available track time, and other factors which cannot be considered here. Each transit system must review costs prior to implementation or modification of a rail grinding program.

However, there is a cost associated with providing effective grinding, which will be briefly reviewed here. Rail grinding can be provided by a full service grinding contractor, or by the railroad's own forces using a purchased rail grinding machine. This analysis will be based on a full service rail grinding contractor providing a 20-stone-self-propelled rail grinder with fully adjustable motors, such as would be most effective for profile grinding. (Note: if the grinder used does not have fully adjustable motor capabilities, then the cost of profile grinding can be significantly higher due to the need to constantly adjust motor positions, which is a time and labor intensive activity for grinding motors that are manually adjustable.)

Noting that the pass-mile requirements for the curved track only are between 360 pass miles (defect grinding) and 540 pass miles (profile grinding) per year, the cost of grinding can be determined based on availability of track time for the grinder. Assuming 4 hours of working time (spark time) exclusive of travel and clearance time, a cost per pass mile of approximately \$500 can be achieved using a contract service. This translates into an annual grinding cost of \$185,000 (defect grinding only) to \$277,000 (profile grinding). These costs are based on having a defined rail grinding program on hand when the contract grinder is available and having a fully defined pattern, program, and all support functions on hand.

These costs and savings are summarized in Table 8-2. As can be seen from Table 8-2, the net savings due to grinding

TABLE 8-1 SAVINGS ASSOCIATED WITH LEVEL OF GRINDING

	Moderate Defects	Severe Defects
Surfacing Savings	\$ 2,000	\$ 4,800
Energy Savings	\$ 3,000	\$ 6,000

TABLE 8-2 ECONOMICS OF RAIL GRINDING FOR VARIOUS LEVELS

	Defect Grinding - Level 1	Profile Grinding - Level 2
	Annual Savings/Cost	Annual Savings/Cost
Rail Savings	\$243,079	\$ 367,119
Wheel Savings*	\$ 0	\$ 293,091#
Surfacing Savings**	\$ 4,806	\$ 4,806
Energy (Fuel) Savings**	\$ 6,310	\$ 6,310
Total Savings	\$ 254,195	\$ 671,326
Cost of Grinding	\$ 184,500	\$ 276,750
Net Savings	\$ 69,695	\$ 394,576
Return on Investment	38%	143%

* Savings from profile grinding only

** Savings from corrugation/surface defect control (also achieved by profile grinding)

Maximum savings

NOTE: This does not include savings on tangent track with corrugations.

varies significantly, based on whether conventional or profile grinding is performed. For conventional grinding, the net savings is on the order of \$70,000 per year corresponding to a return on investment (ROI) for grinding of approximately 38%. For profile grinding, the net savings ranges between \$250,000 and \$400,000 per year. This corresponds to an ROI of between 90% and 143%. Finally, if rail savings *only* were considered, the net savings due to grinding would still be between \$60,000 (defect grinding) and \$90,000 (profile grinding) per year, corresponding to an ROI of approximately 33%.

Grinding costs at SEPTA include a capital cost of approximately \$700,000 to \$800,000 for an 8-stone profile grinder with computer control. In addition, a capital cost of \$200,000 should be added for an environmental car which vacuums up the grinding dust and debris. Operating costs include labor and benefits for a grinder, mechanic, foreman, and two flagmen, plus material costs for roughly two sets of grinding stones per 4 hours of grinding. With this configuration, SEPTA is able to grind an average of 500 ft of track per day, including multiple passes (14).

8.2.1.5 Limitations

Care must be exercised in grinding wood tie-and-ballast or wood tie track on aerial structures to ensure that fire is not caused. The practice at some systems is to follow the grinder and douse fires that may occur. On these systems, less intensive grinding may be appropriate. Some grinders may have difficulty negotiating curves in tunnels, or may be unable to grind rail at very short radius curves. Vertical axis grindings may be unable to grind embedded girder rail without special provision.

8.3 GAUGE WIDENING VERSUS NARROWING

Discussions with various track designers indicate that gauge widening appears to be a holdover from steam loco-

motive days, and is not specifically necessary to prevent excessive flange wear. In fact, gauge widening promotes crabbing, since the natural tendency of a truck is to crab its way through a curve, with the high rail wheel of the leading axle riding against the high rail. On the other hand, gauge widening allows the development of a rolling radius differential where tapered wheel profiles are used, which can be further accentuated with asymmetrical grinding of the rail head as described above. SEPTA has observed that the wheel and rail gauges used on trolley systems typically vary by only $\frac{1}{8}$ in. The slight variation in gauges necessitates widening in curves to prevent the flanges from binding.

The first known short radius curved track with gauge narrowing has recently been installed. In the summer of 1996, the Portland Tri-Met has replaced the embedded girder rail at some downtown 83-ft radius curves with low carbon steel rail set in cork-impregnated Icosit with $\frac{1}{4}$ -in. gauge narrowing. The running surface and gauge face of the rails were treated with Reflex and Eteka 5 hardfacing, respectively. No squeal has been observed with this newly replaced rail, where before, squeal was a regular occurrence (15). The Portland Tri-Met also employs resilient Bochum wheels, which further help to control squeal relative to solid steel wheels.

8.4 DOUBLE RESTRAINED CURVES

Double restraining rails can be employed to reduce crab angle and promote turning of the truck at gauge widened curves. In this case, the high rail wheel can be brought away from the high rail by the low rail restraining rail, and the low rail wheel can be moved toward the high rail by the high rail restraining rail, thus reducing crab angle and lateral slip, as well as preventing flange contact with the high or low rail. The restraining rail separation would have to be controlled to prevent binding of the wheel set, or climbing of the flange onto the restraining rail. Further, the restraining rails may be liberally lubricated to prevent squeal from developing because of friction between the wheel and restraining rail. This technique has not been studied in detail, but may repre-

sent an avenue for further investigation of wheel squeal noise control. SEPTA has indicated that restraining rails produce squeal, and that it has obtained a significant noise reduction with high rail gauge face and restraining rail lubrication.

8.5 RAIL JOINT WELDING

Rail joint welding reduces impact noise otherwise generated by wheels rolling over the rail joint gap. The MTA NYCT is involved in extensive rail joint welding on at-grade structures, though not on elevated structures. Apart from noise reductions, conversion to continuous welded rail reduces track degradation and maintenance. Field welding involves welding the joint and grinding the running surface very carefully to avoid impact noise caused by dips. Thermitic or electric arc welding is used. Flash butt welding has been used to avoid removing or replacing the rail. Automated flash butt welding cars can be procured for this purpose (16).

8.5.1 Noise Reduction Effectiveness

Joint welding and grinding would be expected to similarly reduce noise to levels consistent with continuous welded rail, provided that the rail is of similar quality and smoothness. A good rule of thumb is that welding of rail joints and grinding will reduce A-weighted noise levels by about 5 dB. Measurements at SEPTA (17) indicate about a 3 to 4 dBA way-side noise reduction after the first grinding of jointed ballast-and-tie track, ostensibly caused by improved rail joint alignment, while reductions due to rail grinding at other sections of track produced 0 to 2 dB noise reduction. The 3 to 4 dB improvement is indicative of the noise reduction that may be achieved by welding and grinding rail joints.

8.5.2 Site-Specific Conditions

The strength of steel elevated structures must be considered when deciding whether to convert to continuous welded rail. Thermal loads induce rail shrinkage or expansion, which necessarily must be resisted by the elevated structure, unless a provision is made for controlled slip via the rail clips. Rail welding has not been considered for the MTA NYCT elevated structures for this reason. However, at concrete or composite steel and reinforced concrete aerial structures, such as at BART, continuous welded rail is used, evidently without adverse effect. Longitudinal slip is designed into the rail clip assemblies to limit longitudinal track loads on the structures. Rail replacement procedures may also play a role in welding or use of welded rail. At the MTA NYCT, rail is replaced in panels consisting of two rails, cross-ties, and fasteners. This approach minimizes installation time and avoids interruption of train service. Replacement of continuous welded rail requires cutting the rail, installing a new section, and re-welding. At curves, high rail wear may necessitate frequent rail replacement, in which case continuous welded rail may not be economical.

8.5.3 Costs

The cost of field welding has been estimated at about \$250 per joint in 1974, or about \$13 per track foot (18). Applying a producer-price-index (PPI) ratio of 2.5 for prices today relative to 1974 indicates that current prices should be in the range of \$600 to \$700 per joint, or about \$30 to \$35 per track foot.

8.6 RAIL VIBRATION ABSORBERS

Rail vibration absorbers consist of resonant mechanical elements which are attached to the rail flange to absorb vibration energy. Though rail vibration absorbers have been proposed as noise control treatments from time to time, they have not been employed within the United States. They have been tested and employed in Europe. The rail vibration absorber is a treatment that may prove valuable at certain site specific locations.

8.6.1 Products

Deutsche Aerospace provides a rail dynamic absorber consisting of a multiple leaf unit weighing about 50 lb which is clamped to the underside of the rail. The technology is licensed to AEG Pittsburgh Daimler Benz Aerospace. AEG is now operating under the name of Adtranz. The model number of the absorber is AMSA 7.

8.6.2 Noise Reduction Effectiveness

Data provided by the manufacturer's representative indicate about 3 to 5 dB rail vibration reduction at 1/3-octave band frequencies between 300 and 2,000 Hz for 111 km/hr Deutsche Bundesbahn transit trains on tangent track. Absorbers were mounted on each rail, one between each rail fastener. The weight of each absorber is 50 lb. If one were to simply increase the weight of 115/yard rail by 50 lb per yard, a reduction of rail vibration above the rail-on-fastener resonance frequency and the wheel's first radial resonance frequency of 500 to 600 Hz by about 3 dB might be expected, simply from the added mass. The rail vibration reduction exceeds 3 dB at frequencies above about 700 Hz, and above this frequency the reduction is about 2 dB greater than what might be expected on the basis of mass ratios. Nevertheless, the vibration absorbers would be expected to reduce vibration transmission along the rail, which reduces the effective noise radiation length of the rail, and may help to control so-called "singing rail." Rail vibration absorbers might be effective in eliminating the pinned-pinned resonance of the rail due to discrete fastener supports. There is a distinct possibility that the absorbers might be useful in reducing rail corrugation rates.

No data were provided for wheel squeal noise reduction, but the possibility may exist that squeal noise might be reduced. However, theory of wheel squeal suggests that rail damping treatment should be of little effectiveness in reducing wheel squeal. Experiments are needed to determine any squeal noise reduction that might be obtained.

8.6.3 Site Considerations

A number of site specific considerations must be considered. The possible problems listed below are hypothetical, because of the lack of experience with application at U. S. transit systems.

8.6.3.1 Elevated Structures

There may be some reticence to use vibration absorbers clamped to the underside of rails on aerial structures or open deck steel elevated structures such as in New York, because of concern over safety for people underneath the structure who might be struck by falling absorbers. This problem should be controllable through use of some method of positive retention and inspection. Further, addition of 50 lbs per rail between each tie may cause concern over weight, a concern at older transit systems such as the MTA NYCT and Chicago CTA.

8.6.3.2 Temperature

Deutsche Aerospace did not provide an indication of the temperature range of the AMSA 7 vibration absorber. However, absorbers utilizing an elastomer element and optimized for moderate to high temperatures may lose a portion of their effectiveness at low frequencies. This may be of little importance during winter months when windows in cold climates are kept closed.

8.6.3.3 Snow/Ice

The leaf vibration absorber such as provided by Deutsche Aerospace would appear to be susceptible to freezing in sub-freezing weather with snow.

8.6.3.4 Ballast-and-Tie Track

Vibration absorbers may be impractical on ballast-and-tie track unless they can be positioned clear of ballast. Further, the ballast-and-tie track may provide substantial energy absorption without vibration absorbers, so that the addition of the absorber would provide little additional noise reduction. However, a “singing rail” phenomenon at 500 to 1,000 Hz has been observed at ballasted track with concrete ties and Pandrol clips, where there is little absorption of vibration energy along the rail. In this case, vibration absorbers might prove very effective.

8.6.4 Cost

The costs of rail vibration absorbers is difficult to establish for the U.S. market, due to lack of use. However, they should not cost more than a typical resilient direct fixation fastener. Recent estimates for the cost of a conceptual vibration absorber design were about \$50 to \$100 per absorber. Assuming that absorbers are placed between every other fastener pair, the cost per track foot would be about \$20 to \$40 per track foot. If greater noise reduction is needed, requiring an absorber in each fastener bay, the cost would be \$40 to \$80 per track foot.

8.7 RAIL DAMPERS

A rail damper is a visco-elastic constrained layer damping system applied to the rail web to control wheel squeal, such as the Phoenix AG Noise Absorber Type A-4.1, illustrated in Figure 8-9. This product is held against the rail web with a spring clip, which reaches under and about the rail foot. The treatment can be applied with minimal disturbance of track, provided that it may be made short enough to fit between the

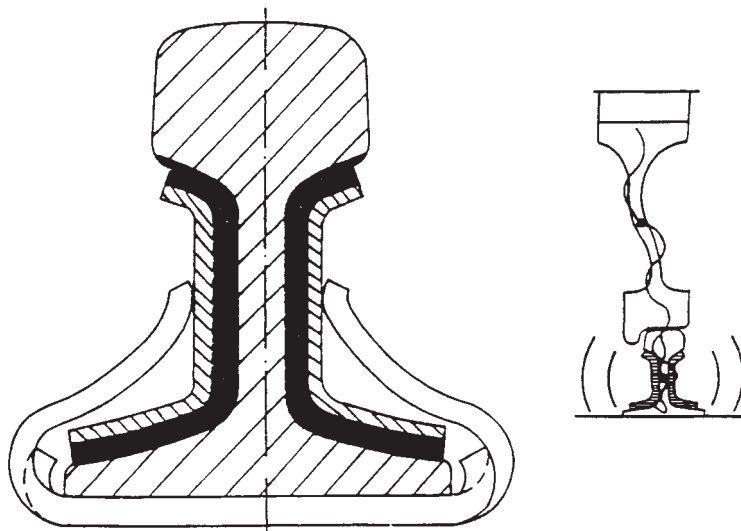

FIGURE 8-9 RAIL VIBRATION DAMPERS (PHOENIX AG TYPE 799323)

track fixation. The product has been produced in Europe for type S 41, S 49, and S 54 rails. Installations include:

- Stuttgarter Strassenbaum (October 1991)
- Societe De Transport Charleroi (Belgium, May 1992)
- Leipziger Verkehrsbetriebe (September 1992)
- Stadtwerke Frankfurt (September 1992)

The product has been installed and tested at the MBTA Green Line Government Center Station (19). The results of the tests are illustrated in Figure 8-10, which indicate that the damping treatment was effective at eliminating a component of squeal at 1,600 Hz. A second component of squeal at 4,000 Hz was not controlled, with the result that the A-weighted noise reduction was not great. Even so, the energy averaged A-weighted noise reductions were on the order of 2 to 5 dB, and a qualitative improvement should be obtained with elimination of the 1,600 Hz component. Identification and treatment of the source of the 4,000 Hz component of squeal would yield further A-weighted noise reductions, with further qualitative improvement.

Extension of these test results to other systems represents an intriguing wheel squeal noise control possibility. However, additional testing at other systems with different curve radii and different types of wheels is recommended. For example, testing of solid wheels at ballast-and-tie curves of

radii on the order of 300 ft would be desirable to determine effectiveness for heavy rail systems.

8.8 RESILIENT RAIL FASTENERS

Resilient rail fasteners are effective in controlling wheel/rail noise to the extent that they provide vibration isolation between the rail and structure and reduce looseness in the rail fixation relative to standard ballast-and-tie track with tie plates and cut-spikes. They are not normally considered as a noise reducing treatment, however, except where vibration isolation is needed to control structure borne noise radiation from aerial structures or groundborne noise and vibration. These latter types of noise are not specifically within the jurisdiction of this manual, though aerial structure noise control is discussed below with respect to fastener design. There may even be a tendency for increased levels of wayside noise with resilient direct fixation fasteners relative to, for example, ballast-and-tie track, due to lack of sound absorption normally provided by the ballast. The design of resilient direct fixation track and resilient fasteners may have a significant effect on rail corrugation growth rates, though insufficient field test data exist to adequately define desirable characteristics for minimizing corrugation. Accordingly, those fastener characteristics which might have an influence on corrugation are discussed below.

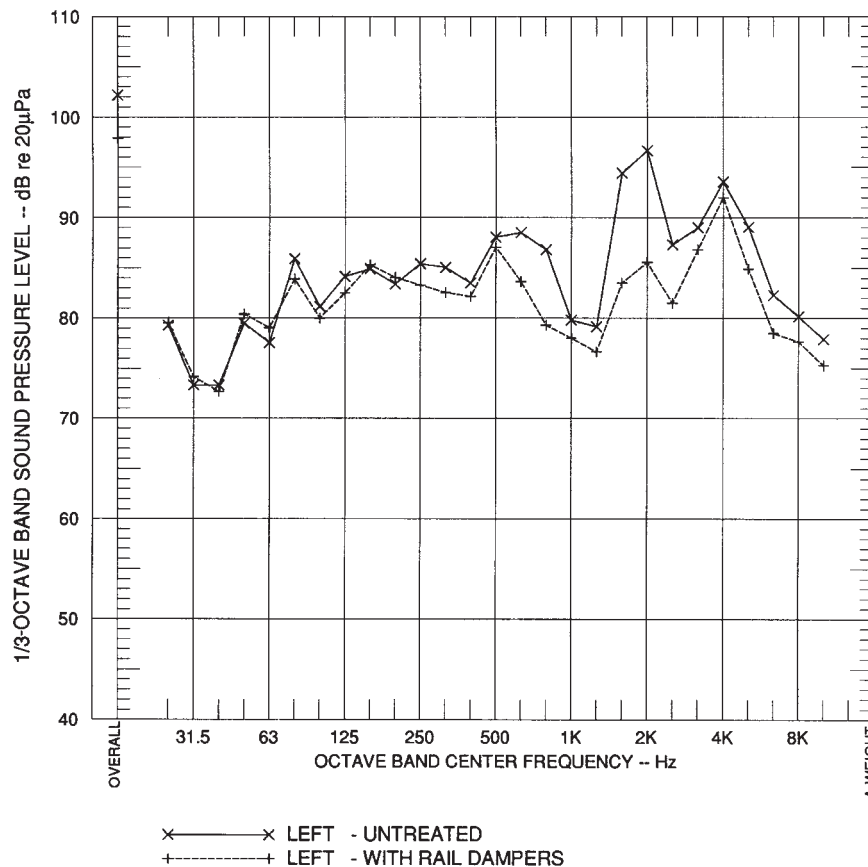

FIGURE 8-10 WHEEL SQUEAL NOISE LEVELS AT THE LEFT-HAND MEASUREMENT LOCATION, 10 FEET FROM THE NEAR RAIL

8.8.1 Characteristics

Rail fastener characteristics are described below.

8.8.1.1 Static Stiffness

The static stiffness is the principal design parameter used to describe a resilient direct fixation fastener. The static stiffness of modern direct fixation fasteners ranges from about 50,000 lb/in. for Clouth's "Cologne Egg," or its equivalent provided by Advanced Track, to about 110,000 lb/in., represented by the Lord Corporation fasteners supplied to BART and LACMTA. Earlier fasteners, such as the TTC or BART Landis fastener, have stiffnesses on the order of 250,000 lb/in. or more. Fasteners consisting of rolled top plates and thin neoprene pads have very high stiffnesses, often in excess of 1,000,000 lb/in. These fasteners should probably not be classified as resilient, because their stiffness may exceed the roadbed stiffness, especially on aerial structures.

8.8.1.2 Dynamic versus Static Stiffness

An important factor in resilient fastener vibration isolation performance is its dynamic stiffness. The dynamic stiffness is normally significantly greater than the static stiffness, because of the hysteretic nature of elastomers. Failing to account for the dynamic stiffness may result in insufficient vibration isolation. Further, the dynamic stiffness may vary considerably from one design to the next, even if the static stiffnesses are equivalent, because of variations in elastomer properties.

The dynamic stiffness is normally described in terms of the ratio of dynamic-to-static-stiffness. The dynamic stiffness of modern resilient direct fixation fasteners manufactured with natural rubber elastomer exhibit a ratio of dynamic-to-static stiffness of about 1.4 or less. Fasteners with synthetic rubber or high durometer elastomers exhibit ratios as much as 1.7 or 2, and are undesirable for vibration isolation.

Very stiff fasteners may impede rail motion at frequencies in the range of 250 to 500 Hz, thus reducing noise radiation by the rail. On the other hand, the rail-on-fastener resonance frequency for very stiff fasteners may be within the range of corrugation frequencies associated with short pitch rail corrugation, and thus may contribute to rail corrugation.

8.8.1.3 Top Plate Bending

The typical resilient fastener has a cast or rolled top plate bonded to an elastomer element. The resonance frequency of the top plate in bending is typically about 600 Hz or higher, and the stiffness of the fastener increases dramatically with frequency prior to this resonance, and thereafter decreases sharply at the resonance frequency. Depending on the mass of the top plate and stiffness, the input mechanical impedance of the fastener also reaches a minimum at the rigid-body resonance of the plate on the fastener stiffness, which usually occurs at frequencies below 500 Hz for modern fasteners. The frequency range above 500 Hz is also comparable with the

pinned-pinned mode of rail vertical vibration due to discrete rail support. The wheel also exhibits lateral vibration modes and a radial anti-resonances above 300 or 400 Hz. These various modes of vibration may combine to exacerbate wheel/rail noise, especially on direct fixation track. Moreover, all of these frequencies are comparable with frequencies associated with short-pitch corrugation. Increasing the top plate resonance frequency in excess of about 1,000 Hz to separate the top plate resonance frequency from rail corrugation frequencies would be consistent with good design practice to reduce corrugation, though this has not been substantiated. The resilient fasteners currently being installed at BART at the new extensions were specified to have a top plate resonance in excess of 800 Hz to avoid coincidence with the rail corrugation frequency typically occurring at about 500 Hz. Fasteners utilizing a cast top plate with thick rail seat area provide high top plate stiffness. Examples include fasteners supplied to BART, LACMTA, and MTA NYCT. (See the discussion concerning top-plate bending and rail corrugation in Chapter 10.)

8.8.2 Rail Damping

Remington has developed a theory of rail fastener performance which includes damping provided by the elastomer, thus predicting a reduction of rail vibration and rail radiated noise. At least part of the noise reduction achieved at steel elevated structures by resilient fasteners relative to standard tie plates and wood ties with cut spikes is due to this damping effect. Just as rail vibration absorbers absorb rail vibration energy, resilient elastomer fasteners also may absorb vibration energy. The degree of vibration and noise reduction is dependent on fastener design, but there is a possibility of tuning the fastener to enhance its vibration absorbing properties by exploiting the 1/4-wave resonance of the elastomer (20). No fastener has yet been constructed to maximize its vibration energy absorbing capability, but such an approach remains attractive. Such a fastener could evidently be constructed with an elastomer thickness on the order of 1 to 2 in.

The top plate bending resonance might conceivably be exploited to absorb vibration energy at the resonance frequency. Although removing the coincidence between rail corrugation frequencies and top plate bending resonance frequency appears to be desirable, tuning the top plate bending resonance and elastomer damping to maximize energy absorption at 500 to 1,000 Hz is attractive. Further study is required.

8.8.3 Products

Resilient fasteners are currently supplied for U.S. transit systems by a number of firms, including Lord Corporation; Advanced Track/Goodyear; American Track Systems, Inc.; Transit Products, Inc.; Landis Sales, Inc.; Clouth Gummiwerke; and Phoenix USA.

8.8.4 Steel Elevated Structures

Resilient fasteners have been incorporated into the wood tie trackwork on steel elevated structures and very soft fas-

teners have been used at composite concrete deck and steel box girder aerial structures to control noise. Very soft fasteners provide the rail with greater support compliance, allowing the rail to vibrate at higher amplitude than would be the case with very stiff fasteners, but provide greater vibration isolation between the rail and supporting structure. The net effect of reducing fastener stiffness on wheel/rail A-weighted noise may be nil or limited to a few decibels. For example, wayside noise levels at MTA NYCT steel elevated structures appear to be about 1 to 2 dBA lower with soft fasteners of static stiffness on the order of 100,000 lb/in. static compared to resilient fasteners with static stiffness greater than 200,000 lb/in. (21). Similar results have been obtained at BART (22). Low frequency structure radiated noise is reduced at WMATA and MTA NYCT over a limited frequency range on concrete deck/steel box composite aerial structures, though the A-weighted noise reduction is limited (23).

Resilient rail fasteners with positive retention rail clips, such as Pandrol clips, eliminate clatter between the rail and tie plate, thus reducing impact forces and noise on older systems which otherwise use wood ties and standard tie plates, such as the MTA NYCT and CTA. MTA NYCT has replaced all steel elevated structure track with resilient rail fasteners, wood ties, and new rail. The noise reduction benefit obtained just by eliminating the standard tie plate in favor of resilient rail fasteners is on the order of 3 to 6 dBA, based on single event noise exposure measurements (24).

The radiation of noise from steel elevated structures is very complex, involving not only wheel/rail interaction but structural responses that are difficult if not impossible to quantify. The most comprehensive effort in this regard includes work developed by Remington (25). By far, the most effective treatments for elevated structure noise control appear to be elastomer fasteners combined with continuous welded rail or jointed rail with tight rail joints, rail grinding, and wheel truing. Since retro-fit of most of the steel elevated structures with resilient fasteners, the MTA NYCT has received very few complaints concerning noise (26).

8.8.5 Costs

Costs for resilient fasteners vary considerably from procurement to procurement, depending on quantities ordered, and the degree of qualification testing required. Typical costs range between \$50 and \$100 per fastener, including anchor bolts, anchors, and clips. Benefits may include reduced rail maintenance with direct fixation track relative to ballast-and-tie track, and reduced track maintenance for wood ties and resilient fasteners on older structures relative to standard tie plates with cut-spikes.

8.8.6 Site-Specific Conditions

Site-specific conditions include the following:

Temperature range and longitudinal slip requirements. High temperature variations may induce substantial longitudinal expansion and contraction of the rail, which may be of serious concern with respect to elevated structures. Rail

buckling must be considered. Fastener rail clips are normally specified to allow longitudinal slip to accommodate rail expansion and contraction.

Corrosion and electrolysis. Direct fixation fasteners are effective insulators. However, condensation and moisture within tunnels, coupled with electrolysis, may cause fasteners to deteriorate, for which certain remedies have been developed, such as galvanizing or coating with rust inhibitors. Stray currents must also be considered.

8.9 SPECIAL TRACKWORK

Special trackwork includes switches, turnouts, and crossovers. Significant impact noise may be generated by wheels traversing frog gaps associated with special trackwork. Impact noise may be controlled by grinding the frog to provide as smooth a transition as possible for each wheel to pass from one side of the flangeway to the other. Special frogs, including moveable point, swing nose, and spring frogs, have been developed to minimize impact forces by eliminating the fixed gap associated with the frog. Because the frog gap is the major cause of the increase in noise when a train passes through a turnout, the use of special frogs to reduce special trackwork noise is a practical noise control provision for many transit systems.

8.9.1 Types of Frogs and Manufacturers

The various types of frogs and their manufacturers are discussed below.

8.9.1.1 Rail Bound Manganese Frogs

Rail bound manganese frogs are used at many transit systems, and serve as the baseline for the purpose of discussing noise control. These frogs include a fixed gap and conventional rail wrapped around a manganese center. This places the wear resisting element at the discontinuities of the frog, which reduces wear, but generates the impact noise previously discussed when wheels traverse the fixed gap. In addition, there are two joint gaps just before and after the manganese insert which also produce noise. The typical cost of a rail bound manganese frog is approximately \$6,000 (1994 dollars).

8.9.1.2 Welded Vee Frogs

Welded vee frogs are fixed gap frogs constructed from standard rolled rail. The welded vee holds together two tapered rails with a continuous longitudinal weld. This design eliminates the two joint gaps associated with the rail bound manganese frog, but does not eliminate the fixed gap.

8.9.1.3 Flange Bearing Frogs

Flange bearing frogs provide support to the wheel flange while traversing the frog gap in embedded track. A properly installed frog supports the flange, maintains the wheel height

through the frog, and reduces the impact forces associated with the wheel traversing the gap. The depth of the flange support below the top of rail is critical in providing a smooth transition through the gap. If this support is too high or too low, then the transition is not smooth and the impact noise is not eliminated.

8.9.1.4 Moveable Point Frogs

Moveable point frogs, also known as swing nose frogs, are perhaps the most effective at eliminating the impact noise associated with fixed gap frogs. Modern movable point frogs have been developed in Europe for high speed railways, and current applications in North America include limited use on the AMTRAK Northeast Corridor, limited use on heavy freight railroads to reduce frog maintenance, and use on transit systems such as Vancouver ALRT and Detroit CATS where the small diameter wheels cannot safely traverse a frog gap. The gap of the frog is eliminated by laterally moving the nose of the frog in a direction corresponding to the direction of train travel. The moveable point frog generally requires additional signalling, switch control circuits, and an additional switch machine to move the point of the frog. The additional cost of the moveable point frog has been estimated to be as high as \$100,000 when the additional design, construction, material, and maintenance costs are considered. Manufacturers of moveable point frogs include (1) Voest-Alpine, (2) Cogifer, and (3) Balfour-Beatty.

8.9.1.5 Spring Frogs

Spring frogs also eliminate the impact noise associated with fixed gap frogs for trains traversing the frog in a normal tangent direction. The spring frog includes a spring loaded point which maintains the continuity of the rail running surface for normal tangent operations. For diverging movements, the normally closed frog is pushed open by the wheel flange. There may be additional noise associated with trains making diverging movements, because the train wheels must still pass through the fixed portion of the frog. Thus, use of these frogs in noise sensitive areas where a significant number of diverging movements will occur will not significantly mitigate the noise impacts associated with standard frogs. The additional cost of a spring frog is on the order of \$12,000, compared to approximately \$6,000 for a standard frog. Manufacturers of the spring frog include Voest-Alpine.

8.9.2 Noise Reduction Effectiveness

There are limited data regarding the noise reduction achieved with moveable point or spring frogs relative to standard frogs. Typical wayside noise levels for standard frogs are 6 to 10 dBA higher than normal rolling noise levels on tangent track with continuous welded rail, although levels as

high as 15 dBA over normal have been measured at SF Muni for older style embedded track turnouts for operations at speeds less than 25 mph at a distance of 25 ft. This increase may be speed related, because the wheel/rail rolling noise generated at low speed is considerably less than for higher speed operations, so that impact noise may be dominant at low speeds. The difference between impact noise and rolling noise is less for high speed operations than for low speed operations, and impact noise may be masked by rolling noise at high speed. This appears to be true for AMTRAK operations on the Northeast Corridor, where wayside noise measurements showed virtually no difference for operations on standard ballast-and-tie track with a #20 rail bound manganese frog and a #30 movable point frog. However, impact noise from BART trains traversing well used special trackwork at 70 mph is quite audible.

In July 1992, a series of tests of both wayside noise and vibration were performed at the BART test track to obtain a quantitative evaluation of the reduction of noise due to the use of a movable point frog. Measurements were made at the same location on different dates with standard ballast-and-tie track, a #10 rail bound manganese frog and a #10 moveable point frog. The frogs were installed on the near rail of the test track, though entire turnout assemblies were not installed. Wayside noise test results obtained at 25 ft and 50 ft from the track centerline indicate that train operations on the moveable point frog totally eliminated the impact noise, but generated a strange howling or whining noise as each wheel passed over the frog. The cause of the aberrant noise is unknown and is uncharacteristic of other movable point or spring frogs which have been evaluated on a qualitative basis. The noise could be due to improper installation.

Only limited noise data for spring frogs have been obtained. Interior noise data obtained by WIA indicate that the spring frogs installed at a crossover in the subway connector of the Howard-Dan Ryan Line in Chicago are effective at controlling impact noise.

No quantitative data for the noise characteristics of modern flange bearing frogs have been located, although the mechanism for reducing impact noise of light rail trains operating at slow speeds on embedded track in streets appears promising.

Some manufacturers have claimed that wayside noise is reduced with the use of welded-Vee frogs. Measurements made on the BART Concord Line for in-service conditions indicate that wayside impact noise due to trains traversing welded-Vee frogs are generally 6 to 10 dBA greater than for standard ballast-and-tie track. This increase is typical of the rail bound manganese frog, which suggests that the welded-Vee frog does not provide effective impact noise reduction.

8.9.3 Costs

As previously indicated, moveable point frogs have been used on a limited basis by mainline heavy haul railroads to

reduce maintenance costs. However, as previously indicated, the capital costs of moveable point frogs are greater than any of the others discussed here. The cost of a turnout with moveable point frog can be on the order of \$100,000 higher than the cost with a standard frog.

Reduced maintenance costs are expected for the frog for rail transit applications as well as for freight, although frog maintenance is generally not a major cost factor for transit systems. Increased maintenance associated with the additional switch machine and other signalling equipment may negate the benefit of reduced maintenance of the frog for transit system operations.

The cost of the spring frog is estimated to be about \$12,000, or \$6,000 more than the cost of a standard rail bound manganese frog. Thus, the cost of a spring frog is considerably less than that of a moveable point frog.

8.9.4 Site-Specific Conditions

The ability to use moveable point frogs, spring frogs or flange bearing frogs is dependent on a number of factors, including:

- Turnout size and train speed – High turnout speeds may be accommodated with moveable point frogs. Thus they are applicable to large turnouts. Spring frogs must be limited to turnouts of low train speed (approximately 15 mph) for diverging movements, and are most practical for turnouts of short radius. Although the use of flange bearing frogs is not speed limited for most transit use, the noise reduction benefits will be most readily realized for low speed operations typical of light rail transit operating on embedded track.
- Spring frogs are generally unsuitable for modern signalling systems which require positive directional indicators.
- Spring frogs will not eliminate the impact noise of the wheels traversing the frog gap for diverging movements, and thus the noise reduction capability where diverging movements are routine is limited.
- Spring frogs, unless heated, are not practical in sub-freezing weather. At the CTA, spring frogs are exclusively used in subway applications.

8.10 RAIL LUBRICATION

This section concerns wayside lubrication approaches to controlling wheel squeal and wear at curves. Onboard lubrication is discussed in Chapter 7, and much of the discussion presented there is also applicable to this section.

There are two views concerning the generation of squeal, both of which may be correct. The first and most attractive theory holds that wheel squeal is caused by lateral creep and stick-slip of the tread across the rail head, with inhibition of squeal by flange contact (27). The second and popular theory

is that wheel squeal is caused by flange contact and associated stick-slip excitation of the rail and wheel. Except for inhibition of squeal by flange contact, both of these squeal-generating mechanisms may exist, though the physics of the latter theory are not described in the literature. The former squeal generating mechanism is described in Chapter 4.

8.10.1 Background

When a vehicle travels around a curve, the flange of the outside leading wheel of the each truck bears against the gauge face of the outside rail (high rail) of the curve, causing side or gauge face wear. The flange contact at the high rail induces a torque on the truck, causing the truck to crab in the curve, possibly inducing trailing wheel flange contact at the low rail, and increasing lateral creep across the rail head. Thus, substantial wear may occur at the gauge face of both the high and low rails. In addition, a stick-slip mechanism can be introduced, whereby friction-induced vibration at the wheel tread/rail head interface can generate noise, i.e., squeal. Thus, lubrication, as used in the rail transit environment, is generally used to address one or both of these two problems, i.e., wear and noise. Many transit properties apply lubricant to reduce the squeal noise noted above, although reduction of rail and wheel wear is the primary criterion for lubrication.

Lubrication is fundamentally limited in controlling wheel squeal, because tread and rail running surfaces cannot be lubricated without loss of adhesion and braking effectiveness. Loss of braking effectiveness may result in wheel flattening, which produces excessive rolling noise, a counter-productive result of improper lubrication. As noted above, the most attractive theory of wheel squeal holds that lateral creep of the tread across the rail running surface is the primary source of squeal, rather than flange contact, yet only the flange may be lubricated, and then only lightly, although lubrication of the flange may improve curving, reduce crab angle, and, thus, reduce squeal.

Aural and visual observations at the MBTA Green, Blue, and Red Line's restrained curves indicate that wheel squeal is associated with substantial lateral creep and flange contact, even with lubricated restraining rails (28). The possibility exists that adjustment and lubrication of the low rail restraining rail to prevent excessive crabbing and flange contact at the high rail might reduce the propensity for lateral stick-slip between the rail running surface and tread. At double restrained curves, the high rail restraining rail can be adjusted to further reduce crabbing angle and flange contact at the low rail. There is no limitation on lubrication of the restraining rails, since these contact the back side of the wheel tire and flange, and exploitation of lubricated restraining rails to control curving appears to be worth pursuing for squeal reduction. Wheel squeal also occurs at the Sacramento RTD 82-ft-radius restrained curves without high rail flange contact (29), suggesting that lubricating restraining rails will not entirely solve the problem of wheel squeal.

To reduce wear, lubrication with a low coefficient of friction lubricant between the wheel flanges and the gauge face of the rail is commonly used. Lubrication of the gauge face of the high rail in curves has been used over 50 years to reduce the rate of wear of the rail, particularly gauge face wear in curves. However, only in the last decade has hard research data become available to support the significance of benefits associated with rail lubrication. These benefits include not only wheel and rail wear reduction, but also reduction in energy (fuel) consumption.

Lubrication procedures for noise reduction are not as well defined as for wear reduction. Some properties rely on a layer of lubricant between the wheel flange and the rail gauge face to reduce slip-stick around the curve and thus reduce noise. Another approach that has been advocated is the application of a high friction lubricant, or friction modifier, to the wheel tread, to modify the friction versus creep curve of the wheel tread and the top of the rail head, an approach intended to directly reduce the stick-slip squeal mechanism noted above. (These latter procedures are discussed with respect to onboard treatments.) One railroad property has experimented with hand application of the friction modifier to the rail head to control squeal. An intriguing possibility is automatic application of friction modifiers to the wheel tread by wayside applicators as the wheel enters a curve, though such equipment are not available.

8.10.2 Acoustical Benefits

Characterizing squeal noise is difficult, because of the intermittent or unpredictable occurrence of squeal. There are two methods: (1) maximum level and (2) root-mean-square, or energy equivalent level, over the duration of curving. The former method addresses the audibility of squeal noise, and also addresses the degree of discomfort experienced by persons located close to the track (e.g., pedestrians at street corners, or transit patrons in vehicles with open windows). The latter procedure addresses the duration and occurrence of the squeal noise, useful for predicting community noise levels such as energy equivalent level (L_{eq}) and day-night level (L_{dn}). Both peak and energy equivalent measures should be employed, and noise reduction methods should attempt to reduce both.

From a practical point of view, the maximum squeal noise level reduction is not as important as elimination or reduction of the duration or occurrence of squeal. Once a regenerative system begins to squeal, the amplitude tends to saturate, limited only by material damping and friction in the system. Still, lubrication does tend to reduce the amplitude and duration of squeal noise, and, thus, is attractive, even if squeal is not entirely eliminated. A lubrication procedure should be deemed at least marginally successful even if it only reduces the occurrence and not the amplitude of squeal. A reduction of the occurrence or duration of wheel squeal by a factor of two will reduce wayside energy equivalent noise levels by 3 dB, even though the maximum level is unaffected.

The noise reduction effectiveness of lubrication can be substantial at curved track. Without lubrication, wheel squeal maximum noise levels may exceed 100 dBA (Toronto reports levels as high as 110 dBA, though the measurement distances are not known). With lubrication, passby noise levels have been reduced to those of rolling and auxiliary equipment noise. Thus, typical noise reductions are on the order of 15 to 25 dBA.

An automatic wayside lubricator employed at SEPTA is effective in reducing squeal at a turnaround. Both rails are fitted with flange lubricators, and there is some migration of lubricant to the rail head. Squeal is eliminated for most of the curve. However, at the end of the curve, there is some re-emergence of squeal, attributed to loss of lubricant.

8.10.3 Lubrication Application Techniques

The techniques of lubricating the rail head vary significantly, depending on operating environments and external factors. While rail lubrication techniques have been in use for many years, they have met with varying degrees of success. In general, the two approaches that can be utilized in rail lubrication include wayside lubrication (with lubricators that are permanently located at fixed points in the track), and onboard lubrication (lubricators that are mounted on a moving vehicle.) The discussion presented below concerns wayside lubrication systems, while onboard lubrication is discussed in Chapter 7.

Wayside lubrication is the traditional approach that has been used by railroads and transit systems for many years. Most of these lubricators use some form of mechanical applicator system, such as a wiping bar, to apply a predefined amount of lubricant to each passing wheel flange. Thus, every wheel of every train gets a small amount of lubricant applied to its flange, which in turn carries the lubricant along and applies it to the rail (or rails) for a distance beyond the lubricator. This carrying distance is limited, however, so that wayside lubricators must be located at periodic intervals along the curve. Very often the level of lubrication varies with distance from the lubricator, climate (temperature and rainfall), train speed, grease characteristics and other factors. In addition, the remote nature of wayside lubricators makes inspection and maintenance difficult. Recent developments in wayside lubricator technology include more reliable wheel sensing and applicator systems, and more specific attention on lubricator inspection and maintenance.

The wayside lubricator is fixed to the track near the beginning of a curve, and dispenses a small amount of lubricant to each wheel flange of a train passing over it. This lubricant is in turn deposited along the curve, on that part of the rail that is in contact with the wheel flange. A film of lubricant is thus applied to the high rail for the complete length of the curve. If wheel squeal is indeed produced by lateral creep of the wheel tread across the rail head, the success of flange lubrication in reducing wheel squeal may

be due to unintended migration of small amounts of lubricant to these surfaces.

For very limited circumstances, hand application of lubricants can also be used. However, hand lubrication should be used on a spot basis only, since it is extremely difficult and expensive to manually apply lubricant on a regular basis through the length of a curve. Wayside lubricators have traditionally been used for wear reduction, while hand application has been used for both wear and noise reduction (and also derailment prevention).

Dry lubricants which provide a low coefficient of friction are applied to the wheel flange by stick lubricators attached to the vehicle. LCF dry lubricants reduce the coefficient of friction to about 0.06, which may be compared to 0.02 to 0.04 for liquid lubricants. A particular advantage of dry lubricants is that they may be less likely to migrate from the flange area to the running surface of the rail, and thus less likely to compromise traction.

Water spray by wayside applicators have been used at several systems to control wheel squeal. An example is the TTC, which uses water sprays during the summer months to control squeal, and rail corrugation and wear, at curves. Both the high and low rails are thus treated. The system is evidently made by the TTC. Water spray is used at the SRT system at both high and low rails during the summer (survey questionnaire return). Water spray has been reported to reduce wheel squeal by 18 dBA at a short radius curve at the WMATA system (30). However, water spray could not be used during winter periods of freezing weather, and was thus not utilized as a long-term noise control method.

8.10.4 Current Railroad and Transit Practices

Current practice in the railroad and transit industries is to lubricate the rail to reduce wheel and rail wear, and to a lesser extent noise. Actual practices have been evolving in the last decade, with an increasing use of lubrication due to the definable and measurable benefits associated with lubrication.

Virtually all of the transit systems in the United States are using wayside lubricators (though one was on an experimental basis). In addition, while a few problems with sliding trains have been reported, these appear to have been corrected by proper attention to and maintenance of the lubricators. For large properties such as MTA NYCT and CTA a large number of wayside lubricators are currently in use. Other systems also use hand lubrication for noise control.

8.10.5 Rail Lubrication Cautions

While the benefits of rail lubrication have been well documented, there are a few cautions in regard to the lubrication of the rail (and the wheel). While most of these caveats refer to greases, they can also apply to onboard stick lubricants which are misapplied or not properly placed. While these

cautions in no way detract from the benefits of rail lubrication, there are potential problem areas that may arise as a transit system's lubrication program is expanded.

These cautions can be divided into three basic areas:

1. Over-lubrication,
2. Wheel/Rail dynamics, and
3. Wear versus fatigue.

The concerns regarding over-lubrication are generally well known. Over-lubrication has been generally defined as the condition where lubrication is present *on top* of the running surface of the rail (this is not the case with the high-friction lubricant intended to be applied to the rail head or wheel tread), though this may be the very mechanism which produces effective wheel squeal noise reduction. With over-lubrication, several classes of problems stemming from operating difficulties associated with wheel-slip can arise. These problems include the slipping of trains during stops, particularly station stops, and the stalling of trains on grades, due to the reduction of the coefficient of friction between the wheel and the rail (and the corresponding reduction in effective traction). Other operating problems associated with train handling, train action, or general operations, can also occur. Over-lubrication frequently occurs when the wayside lubricators are made to produce a higher output level than appropriate in an attempt to extend the distance covered by the lubricator (i.e., extend the "carry" of the lubricant).

In addition to these operating problems, maintenance problems due to over-lubrication can occur, including the formation of wheel burns (and their associated rail and track problems) due to wheel slippage on lubricated rail heads. Also, decreased efficiency of ultrasonic inspection equipment can occur if a layer of lubrication and dirt is built up on top of the rail.

The second class of concerns associated with lubrication has been reported recently as a result of an investigation into the effect of lubrication on wheel/rail forces. Specifically, these concerns are associated with the lubrication of one rail of either a curve or a section of tangent track. As the lubrication increases on *one rail*, the wheel/rail forces, the corresponding L/V ratios, and the associated railhead lateral deflections (dynamic gauge widening), all increase. However, when lubrication is simultaneously applied to the other rail, so that both rails are lubricated, both the forces and the corresponding deflections decrease.

The third area of concern regarding the increased use of lubrication is the emergence of rail fatigue, both surface and internal, as the dominant failure criterion for curves as well as tangent track. This is usually not a serious concern for transit systems with their lighter axle loads.

In general, the documented benefits of rail lubrication indicate that increased application of rail lubrication is economically justifiable for general rail application. In fact, lubrication offers the potential for significant savings in several

areas of railway operations, including wheel and rail wear and fuel consumption. However, like any maintenance procedure, rail transit personnel should be aware of the potential problems associated with this procedure.

8.10.6 Economic Considerations

The economics of lubrication for rail and wheel wear are extremely significant with high ROIs (return on investment) reported for conditions where wear has been reduced by effective use of lubrication. To the extent that high noise levels due to stick-slip vibration are occasioned by high wheel and rail wear rates, rail lubrication for noise control should result in a positive ROI. For example, recent experience at SEPTA indicates that the ROI due to increased rail and wheel life is between 85 to 90% for moderate to good lubrication at curves, energy savings notwithstanding. The return on freight railroads is even greater, due to the heavier axle loads and more severe operating environment. This order of magnitude of benefit has been experienced at other properties as well (31).

8.10.7 Lubricant Products and Manufacturers

Lubricant products and manufacturers include

- Lubriquip
- Century Lubricating Oils: Centurail Track PL graphite grease
- D. A. Stuart Co., SURBOND 71 MT6 Grease
- Texaco 904
- Moliplex EP-2 non-graphite grease (WMATA)
- Exxon Corporation: Van Estan No. 10
- Superior Graphite Company, #30, #32, #37 flange lubricants
- Intek, Railube 1200 (Represented by American Track Systems)
- SWEPCO 604

Examples of automatic lubrication systems include

- Rails Co. Electro/Pneumatic (used by TTC)
- SRS Clic-o-Automatic (used by TTC)
- X Electric (Used by WMATA)

The Toronto Transit Commission lubricates both the high and low rails and restraining rail during the winter with Rails Co. Electro/Pneumatic and SRS Clic-o-Automatic wayside lubricators and SURBOND 71MT6 grease. At the surface track system, grease is manually applied during the winter, at high, low, and restraining (girder) rails at loops. At the SRT system, grease (SURBOND) is used on the high rail only during the winter, using a Clic-o-Automatic system (questionnaire return).

The St. Louis Metrolink manually lubricates the restraining rail at curves, employing a Century Lubricants Centurail Track PL graphite grease.

SEPTA manually applies a graphite grease made by various manufacturers to the restraining rails, and also employs an automatic lubrication system at one of its rail loops (questionnaire and personal observation).

The Port Authority Trans-Hudson Corporation employs track-mounted grease lubrication, and also employs Texaco 904 or Exxon Van Estan No. 10 to high and restraining rails, using automatic and manual applicators. The cost is indicated by the survey questionnaire response by PATH as \$400,000 per year.

8.10.8 Site-Specific Conditions

Local conditions must be considered in selecting a lubrication program. These include temperature, rainfall, grade, electrical contact, and environmental pollution.

8.10.8.1 Temperature

Water sprays are not practical in exterior environments where cold weather may freeze the water. The TTC has developed a systems whereby water is used in the summer months and grease in the winter.

8.10.8.2 Rainfall

High rainfall may wash away some of the lubricant. This is particularly relevant to dry-stick friction modifiers, or other dry lubricants such as graphite, or lubricants that are carried in volatile liquids which dry after application.

8.10.8.3 Track Grade

Excessive grade may preclude use of grease as a lubricant since traction may be lost. Lubricants are normally applied to the flange to avoid loss of traction, though some lubricant necessarily migrates to the rail running surface. Water sprays may remain as a viable option, since friction is not seriously affected by the water, provided that freezing temperatures are not encountered.

8.10.8.4 Electrical Contact

There is some concern over loss of electrical contact resulting from the use of lubricants. Water sprays may induce corrosion which is not conducive to electrical contact, and might not be advisable in lightly used track or where signalling may be affected.

8.10.8.5 Environmental Pollution

Environmental degradation by lubricants is a serious consideration. Water sprays would likely pose less of a problem than grease or oil. Lubricants should be biodegradable to the maximum extent possible.

8.11 BALLASTED TRACK

Ballasted track provides substantial sound absorption and reduces wheel rail noise at both wayside and subway areas by about 5 dB relative to direct fixation track, the differences in rail dynamics notwithstanding. These assumptions are supported by measurements at the BART system (32). At the Chicago CTA station platforms, the noise level with ballasted track are up to 15 dBA quieter than at stations with concrete trackbeds (33) (though this may be related to differences in rail condition).

8.12 TRACKBED SOUND ABSORPTION

Installation of sound absorption between the rails, placed directly on the invert with a positive retention system, will absorb some of the sound energy radiated by the rails and wheels (as well as traction power system noise), in a manner analogous to ballasted track. This approach is not particularly attractive due to the need for cleaning, oil spills, or other contamination. Nevertheless, there may be areas where use of between rail absorption might be attractive, such as at curves for reduction of squeal noise inside the vehicle.

8.13 HARDFACING

Rail head treatment or “hardfacing” is the application of a hard alloy metal inlay to the rail head, gauge face, or gauge corner to inhibit excessive rail wear. The procedure involves cutting or grinding a groove in the rail surface and welding a bead of material into the groove (Figure 8-11).

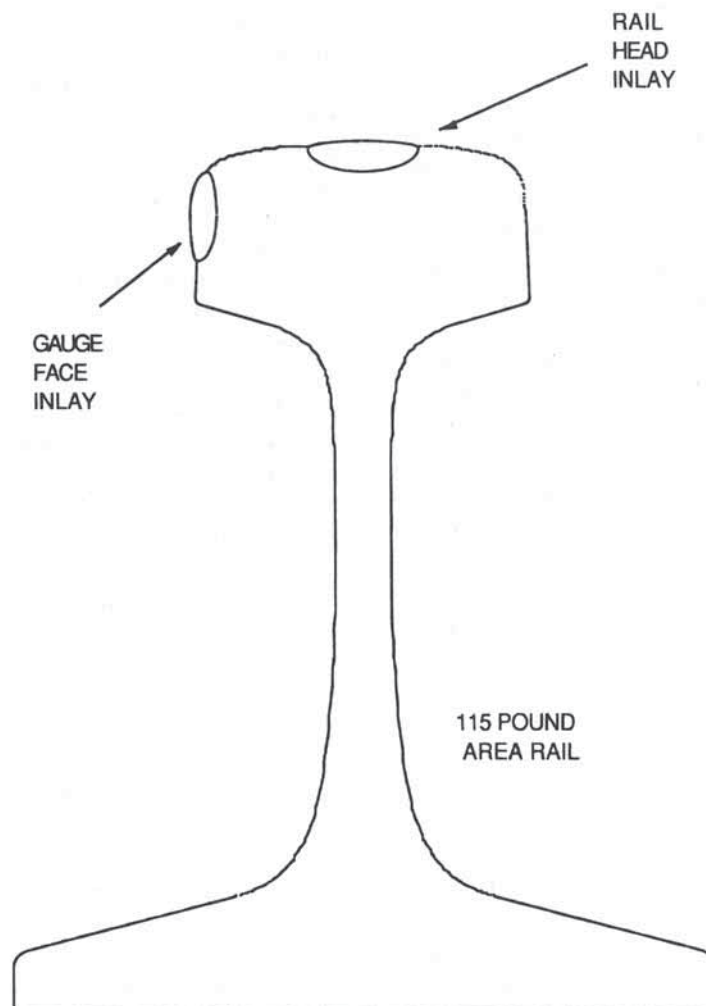

FIGURE 8-11 RAIL HARDFACING

The technique was developed by Electro Thermite GmbH, Germany, and has been used on a limited basis on transit systems in the United States, primarily for wear reduction. The technique has been in use in Europe since the early 1980s for rail corrugation control, and has received some limited use in the United States with little success for squeal noise control.

The general treatment, called by the trade name “Riflex,” actually consists of three different materials:

- Riflex—used for corrugation control,
- Eteka-5—used for gauge face wear control, and
- Anti-Screech—used for squeal noise control.

The material placed on top of the rail is for corrugation and noise control (Riflex) and the material placed on the gauge face of the railhead is for control of gauge face wear (Eteka-5), particularly in sharp curves. Rail with a combination of the two, referred to as “Combi Rail,” consists of weld beads on both the top and gauge face of the railhead. The Anti-Screech treatment is intended for reduction of wheel squeal. All three systems are produced in the same way, though different alloy fillers are used for each of the three.

The Riflex treatment for rail corrugation control uses a very hard material, exceeding Rockwell C 58 and 587 BHN (Hultgren Ball). As such, the treatment is harder than alloy rails such as Cr/Si high-strength steel alloy, and is designed to support the wheel without any surface degradation, thus preventing the formation of corrugations. The Eteka-5 material is fairly ductile when applied, allowing for bending of the rail to fit tight radii curves, but quickly hardens to 470 to 500 BHN. The Anti-Screech is a babbitt-like material which remains soft. All three materials can be welded into CWR strings by either electric flash or thermit welding processes.

The Riflex and Eteka-5 treatments are deposited into a groove at the top and/or gauge face of the railhead (Figure 8-11). The shop procedure includes (1) grinding a 20 mm-wide by 5-mm deep groove into the top (or gauge face) of the rail; (2) welding a bead of the alloy into the groove (and extending beyond it); (3) finish grinding the bead; and (4) roller straightening the finished rail. Pre-heat and submerged arc welding are used to deposit the Riflex alloy in two passes so that the height of the filler is well above the rail head. The filler is then rough ground with a stone at various angles and finished with a longitudinal belt sander parallel with the rail. The finished surface of the filler is between 1 mm and 2 mm above the top of the rail. The rail is then straightened, inspected for defects, and shipped. The material is intended for use with low carbon steels. All three products may be applied to embedded girder rail because no straightening is required. The welding process induces considerable distortion of the rail, which may have

some adverse impact on field installation, which should be investigated with the supplier.

The hard Riflex alloys are magnetic, so that they do not interfere with magnetic rail brakes. (The babbitt-like soft Anti-Screech may not be magnetic, though this has not been verified with the manufacturer.) Further, there is no known problem with signalling or current conduction.

8.13.1 Noise Reduction Effectiveness

Hardfacing is a relatively new and largely unproven technique for the control of noise, corrugation and/or wear (34), and its main attraction is evidently the control of wear at curves. However, to the extent that it is effective in controlling corrugation, it would be very effective in controlling corrugation noise. Further, reduction of wheel squeal is a significant benefit. These are discussed below.

8.13.1.1 Corrugation Control

Wear rates with and without Riflex evaluated under laboratory simulation indicated a wear rate of about 0.1 mm per 100 million gross tonnes with Riflex versus 0.5 mm per 100 million gross tonnes without Riflex, amounting to 75% to 80% reduction in wear rate (35). Wheel wear rate was not adversely affected. The running surface of the Riflex treatment remained narrow, while that of the untreated rail broadened very rapidly with increasing load. The wheel wear surface of the test apparatus remained narrow, resulting in minor “grooving” of the wheel tread, for wheel supported by the Riflex rail, while the tread wear band remained broad with the untreated rail. While the laboratory simulation did not represent field conditions with actual vehicles and truck dynamics, the test results indicate that substantial rates of wear reductions are achievable.

Orgo-Thermit Inc. provided numerous photographs of before and after treatment of rail running surfaces, suggesting very favorable performance of Riflex in reducing corrugation rates, or, in some cases, inhibiting formation of corrugation. Examples include the Paris Metro, Frankfurt, Hannover, Stockholm, and Darmstadt systems. These examples include both tangent and curved track, and both ballast-and-tie and embedded track. Tests on the Paris Metro showed that Riflex resisted corrugation for 3 years and 84 MGT at a location where standard rails corrugated within four days. Orgo-Thermite has indicated that Riflex is effective in controlling or inhibiting corrugation at curved track. Examples include Darmstadt, and Hannover.

To the extent that the weldment may exhibit considerable parametric variation, or variation of effective contact width, rolling noise on Riflex would be expected to exceed rolling noise on standard, well-ground rail. No data have been obtained to verify this, however.

8.13.1.2 Wheel Squeal

Wheel squeal is caused by negative damping resulting from a negative slope of the friction versus creep velocity curve for the wheel/rail interface. Van Ruiten (1988) indicates that wheel squeal will be inhibited if the material damping of the wheel and rail is greater than the negative damping due to negative friction-creep curve. Flattening the friction-creep curve will reduce negative damping and reduce or inhibit squeal. The friction versus creep curve can be modified by chemical treatment or hard-surfacing of the rails with the babbit-like anti-screech material (36).

Modification of the friction-creep characteristic through chemical means is well founded. Surface segregation of aluminum in steels, for example, can modify the frictional characteristics of the contact zone (37). The friction-creep slope is perhaps steepest when the metals are of identical composition, as is the usual case at modern transit systems where wheel treads and rails are both manufactured from carbon steel. However, if an alloy is introduced into the rail head, or other “contaminant,” the slope of the friction versus creep curve can be modified, and, perhaps, inhibit squeal.

Hardfacing with Riflex Anti-Screech was evaluated at curved ballast-and-tie track in one of the maintenance yards at the WMATA system. Initially, the treatment was successful in eliminating squeal, reducing passby noise levels by about 20 dB. However, after 3 months of service, passby noise levels were reduced by only about 14 dB, relative to pretreatment noise levels, and there was occasional squeal noise. After 6 months of service, “chronic squeal reappeared” (38). Further, conversations with WMATA personnel indicate that the treatment was effective enough in controlling noise to replace it. The cause of the loss of performance is likely due to wear of the material, allowing wheel tread contact with the native rail steel.

The CTA has a 150-ft radius curve at the Linden Terminal treated with Riflex, though this curve is not in regular service. Wheel squeal is completely absent during a test with a train operated at walking speed. However, the vehicles also incorporate ring dampers, which are effective in controlling noise at curves, so that it is not clear how much of the squeal noise inhibition is due to Riflex and how much is due to ring dampers.

The SEPTA system has employed the Riflex Eteka-5 treatment at short radius curves, and found the treatment to be of limited effectiveness with respect to noise control. However, the treatment is effective in reducing rail wear at curves, and SEPTA intends to continue the treatment, because the cost of treatment is considerably less than rail replacement costs on the order of \$400 to 500 per 39-ft section of standard “T” rail.

One of the principal problems with application of Riflex to U.S. transit system rails is that it has been applied to high carbon steel rails. An effective design might include installation of low carbon steel at curves and treatment with Riflex throughout the curve and short transitions at either end. How-

ever, this approach has to be compared with simply installing head hardened or alloy rail.

8.13.2 Costs versus Benefits with Respect to Wear Reduction

The Riflex/Eteka-5 treatment is usually performed on the rails prior to installation in track. The major differences between the Riflex rails and the standard carbon (or premium; i.e., alloy or heat treated) rails are the initial costs and the relative lives. (Note: the term Riflex is used to refer to the entire range of materials to include Riflex, Eteka-5, Anti-Screech, etc.) Because of the special work performed on the Riflex rails, the initial cost of these rails are significantly higher than that of standard or premium rails.

The initial cost is estimated to be about \$1,500 per rail section, which may be compared with \$400 (year 1995) per standard carbon steel rail section. There may be benefits which further reduce the cost of the treatment, or even produce a positive return on the investment. To assess the relative benefits and costs of the Riflex and Eteka-5 rails, it is necessary not to simply look at first costs, but to examine the total costs of maintaining the rails over the life of the rails. This type of analysis, often referred to as life-cycle costing, combines the initial costs, with the value of the future maintenance activities and future replacement costs.

A present worth analysis is carried out. The present worth analysis determines the cost or value of future maintenance and replacement activities in terms of costs *today*. This has the effect of converting a future stream of costs, be they maintenance, replacement, or other, into an equivalent *first* cost, so that various options, with different costs and maintenance streams, can be readily compared. Furthermore, this comparison is made on the basis of an “equivalent” initial or first cost (i.e., all future costs are brought forward to add to the initial cost to obtain a combined equivalent total cost, at the time of initial purchase or installation.) (This cost can be expressed in terms of an annuity cost, which may be more favorable for cost comparisons, as is the approach used in Chapter 6.)

The benefits of Riflex/Anti-Screech are compared with the costs of hand lubrication at curves on a daily basis, particularly sharp curves. (Note: hand lubrication is carried out by transit systems in limited high noise level areas.)

- Cost of the Riflex is \$1,500 per rail section (as opposed to standard rail which costs approximately \$400 per rail)
- Daily hand lubrication of the rail by a track inspector: \$1.39 per day; 260 days/year (\$362 per year)
- For a rail life of 20 years (reasonable for moderate curvatures on high density lines or sharp curves on moderate density lines) the ROI is 75%.
- For a 15-year life the ROI is 40%.

Thus, this analysis indicates that Riflex can be an attractive alternative to hand lubrication for the purpose of wear

reduction at curves, provided that the Reflex survives over the anticipated life. Analysis of the benefits of Reflex for corrugation control show that it can be a cost effective alternative to grinding, with an improved ROI over rail grinding when the rail has a life of greater than 15 years.

However, the noise reducing capability of Reflex has not been shown to be good or reliable, and where Anti-Screech was effective at WMATA, its life expectancy was limited to months rather than years. This experience suggests that hand lubrication may, in the end, be preferable to Reflex for wheel squeal reduction, regardless of wear reduction capabilities. The reduction of corrugation remains as a possible positive benefit. Great care should be exercised in the selection of rail head inlays for noise control purposes.

8.13.3 Site-Specific Conditions

Reflex evidently cannot be applied to alloy rail, and thus may have limited usefulness at existing sections of track with alloy steel rail rails. This may have been the reason for the loss of performance of the Anti-Screech at WMATA, where the Anti-Screech was reputed to have curled out of the groove.

8.14 RAIL HEAD DAMPING INLAY (AQ-FLEX)

Elektro-Thermit GmbH, Germany, provides rail head treatment by the trade name of AQ-Flex, consisting of a synthetic resin glued to a groove in the rail head, for the reduction of squeal. The procedure has been applied for at least a year at German rapid transit systems, and can be applied to all grades of steel. No operational data have been obtained, but two transit operators which have employed the treatment are

Stadwerke am Main
Verkesbetriebe ZGW
Hanauer Lanstrasse 345
60314 Frankfurt/Main

Chemitzer Verkehrs
Zwickauer Strasse 164
09116 Chemnitz

Elektro-Thermit indicates that there is a subjective reduction of wheel squeal, though no data have been provided.

The vulcanization process is used with all types of rails and is applied so that the wheel does not come into contact with the resin based filler material. The noise is evidently supposed to be reduced by the material damping provided by the resin inlay. The treatment is intended as a substitute for Anti-Screech inlay treatment, also supplied by the same manufacturer. There are significant questions regarding actual performance, wear, and squeal noise reduction.

8.15 HEAD HARDENED, FULLY HEAT-TREATED, AND ALLOY RAIL

Head hardened and fully heat-treated rail are used by many properties for controlling rail wear and corrugation at short radius curves. A recent survey indicates that heat-treated and alloy steel rails exhibit substantially lower corrugation rates (39). No literature have been found concerning the stick-slip characteristics of carbon steel wheels on alloy steel rails.

8.16 FRICTIONLESS RAIL

The MBTA has installed 119-lb/yd rail with modified rail head section at the high rail of the Government Center curve of the Green Line to control wheel squeal. Figure 8-12 illustrates the rail section used. Also included in the track is 132-lb/yd restraining rail at the low rail. Automatic flange lubrication systems lubricate the back side of the wheel flange and thus the contact between the wheel and restraining rail. The trucks have resilient SAB wheels. The MBTA indicated that there was some reduction of noise after installation of the frictionless rail, but, after a period of time, the wheel squeal returned, ostensibly because of wear (40). Visual inspection of the curve indicates that there is substantial crabbing of the truck as it negotiates the curve, with the lead high rail wheel flange rubbing the gauge face of the rail and the trailing low rail wheel flange rubbing against the low rail gauge face; the guard rail is not preventing flange contact at the high rail. Moreover, the crab angle, or creep angle, between the rail and wheels is severe at the leading axle. Most or all of the squeal appears to be coming from the high rail side of the truck. Immediately after installation of the frictionless rail, flanging at the high rail might have been inhibited by the restraining rail. The reduced rail head width would help to reduce flange contact by effectively increasing gauge, though track gauge was measured to be 4'-8⁷/₈"', only 3/8" gauge widening. The noise reduction is attributed by the MBTA to reduction of friction by the reduced rail section, rather than by or in addition to flange contact inhibition. The return of wheel squeal noise suggests that if there was a change of wheel/rail contact friction, it reverted to normal conditions. There is the distinct possibility that reduction of flange contact with the frictionless rail was the principal cause of the initial noise reduction, and that re-establishment of flange contact because of wear of the restraining rail is the cause of the re-emergence of squeal. This could be checked by reducing the flange way between the restraining rail and low rail, which would also reduce the crab angle or creep angle between the wheel tread and rail. If this is successful, the same operating conditions could be obtained with standard rail profiles, rather than frictionless rail, by simply moving the tie plate further out. However, the contact area would be wider for the standard rail section relative to the frictionless rail section. At the present, the frictionless rail does not appear to be effective over the long term.

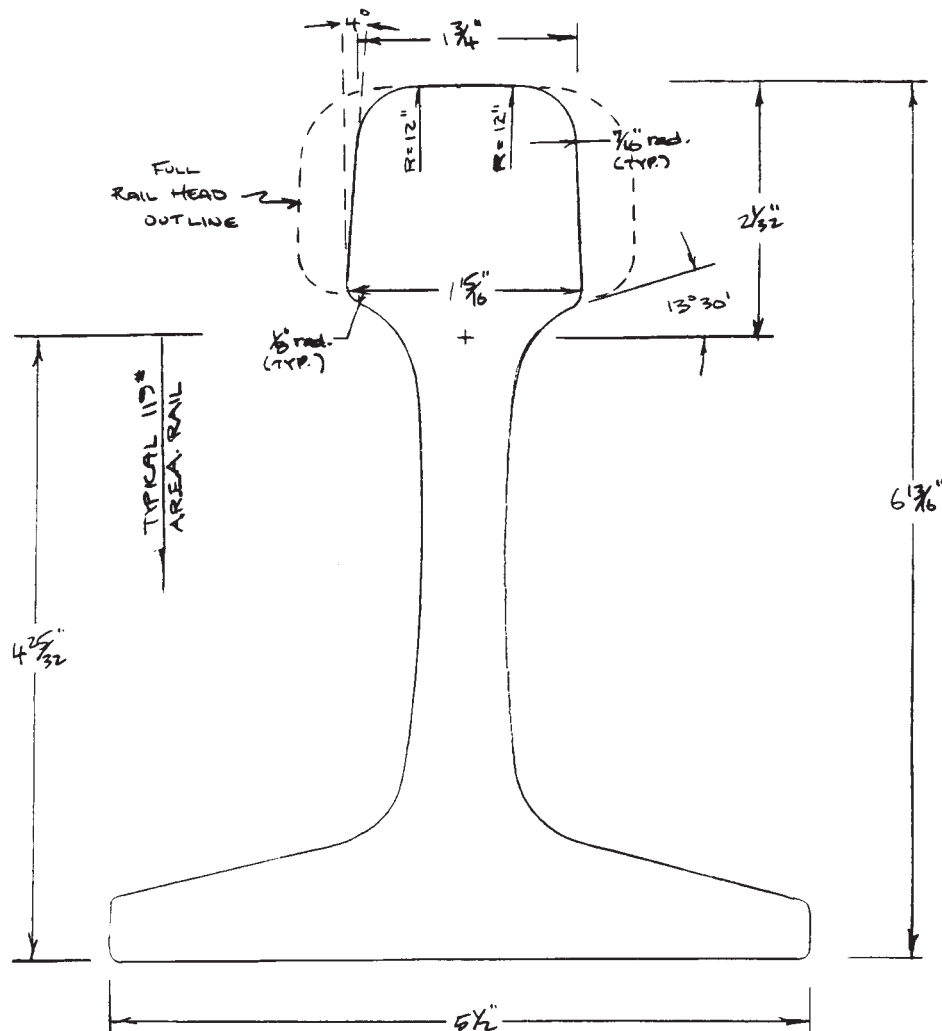

FIGURE 8-12 FRICTIONLESS RAIL PROFILE - MBTA

8.17 REFERENCES

- Jordan, H. R., "MARTA Rail Grinding Practices," Unpublished paper (1994).
- Kalousek, J., and K. L. Johnson, "An Investigation of Short Pitch Wheel and Rail Corrugation on the Vancouver Skytrain Mass Transit System," *Proc., Instn. Mech. Engrs.*, Part F, Vol. 206 (F2), pp. 127-135 (1992).
- Bohara, T., SEPTA, private communication.
- Remington, P. J., *Wheel/Rail Rolling Noise Generation and Control*, Report No. 8020, BBN Systems and Technology, for Wilson, Ihrig & Associates, Inc., TCRP Project C3, Interim Report, Appendix A, p. 39 (October 1994).
- Saurenman, H. J., R. L. Shipley, and G.P. Wilson, *In-Service Performance and Costs of Methods to Control Urban Rail System Noise*, UMTA-MA-06-0099-80-1, Wilson, Ihrig & Associates, Inc., for U.S. DOT/UMTA, Chapter 4, pg. 11 (December 1979).
- Data obtained from J. Cooper of Speno International SA, derived from an article by F. Birman, "Schaffung Annehmlicher Fahrt durch Schienenschleifen" (Obtaining Acceptable Ride by Rail Grinding), *Glaser's Annalen* (April 1956).
- Daniels, L. E., *Rail Transit Corrugations*, Maryland Mass Transit Administration, for U.S. DOT/FTA, FTA-MD-06-0141-93-1, pp. 8-19 (December 1993).
- Cooper, J., "A New Look at Noise and Rail Grinding," *Contact Mechanics and Wear of Wheel/Rail Systems*, Preliminary Proceedings, Ed., J. Kalousek (1994).
- Sunaga, Y., and K. Shi-ina, "A Control of the Rail Surface Roughness for Reduction of Wheel/Rail Noise," *Quarterly Report of the RTRI (Japan)*, Vol. 32, No. 3, pp. 138-144 (September 1991).
- Sunaga, Y., and K. Shi-ina, "A Control of the Rail Surface Roughness for Reduction of Wheel/Rail Noise," *Quarterly Report of the RTRI (Japan)*, Vol. 32, No. 3, pp. 138-144 (September 1991).
- Jordan, H. R., "MARTA Rail Grinding Practices," Unpublished paper (1994) and followup telephone conversation.
- Remington, P. J., N. R. Dixon, and L. E. Wittig, *Control of Wheel/Rail Noise*, Bolt, Beranek and Newman, Inc., for U.S. DOT/UMTA, UMTA-MA-06-0-0099-82-5, p. 265.
- Bohara, T., SEPTA, Private communication (1996).
- Bohara, T., SEPTA, Private communication (1996).

15. Private communication with S. Fassman of BRW, Inc. (September 1996).
 16. Kurzweil, L. G., and L. Wittig, *A Critical Evaluation of Wheel/Rail Noise Control*, Paper Presented at the APTA 1980 Rapid Transit Conference, San Francisco, CA., June 16–19, 1980.
 17. Saurenman, J., R. L. Shipley, and G. P. Wilson, *In-Service Performance and Costs of Methods to Control Urban Rail System Noise*, Wilson, Ihrig, & Associates, Inc., for U.S. DOT/UMTA, UMTA-MA-06-0099-80-1, Chapter 4, p. 6 (December 1979).
 18. Kurzweil, L. G., R. Lotz, and E. G. Apgar, *Noise Assessment and Abatement in Rapid Transit Systems*, (Report on the MBTA Pilot Study), UMTA-MA-06-0025-74-8, pp. 3–13 (September 1974).
 19. Nelson, J. T., “Appendix C: Phoenix Rail Damper Wheel Squeal Noise and Reduction Tests,” *Wheel Rail Noise Control for Rail Transit Operations*, TCRP Project C3, Wilson, Ihrig and Associates, Inc., for the Transportation Research Board (1996).
 20. Remington, P. J., L. E. Wittig, and R. L. Bronsdon, *Prediction of Noise Reduction in Urban Rail Elevated Structures*, Bolt Beranek & Newman, Inc., for U.S. DOT, DOT-TSC-1531, p. 6 (July 1982).
 21. Nelson, T., and G. P. Wilson, *Noise Reduction Effectiveness of Resilient Rail Fasteners on Steel Solid Web Stringer Elevated Structures*, Vol. I, New York City Transit Authority, for U.S. DOT/UMTA, UMTA-NY-06-0087-89-2 (March 1989).
 22. *San Francisco Bay Area Rapid Transit District Demonstration Project*, Technical Report Number 8: Acoustic Studies, Parsons Brinckerhoff-Tudor-Bechtel, NTIS-PB-179-353 (June 1968).
 23. Various tests reports prepared for DeLeuw Cather Co. and Washington Metropolitan Area Transit Authority by Wilson, Ihrig & Associates, Inc., concerning the Rockville Pike A-Route aerial structure noise (mid 1980’s).
 24. Ungar, E., and L. E. Wittig, *Wayside Noise of Elevated Rail Transit Structures: Analysis of Published Data and Supplementary Measurements*, Bolt Beranek and Newman, Inc., for U.S. DOT/TSC, p. C-5 (May 1980).
 25. Remington, P. J., L. E. Wittig, and R.L. Bronsdon, *Prediction of Noise Reduction in Urban Rail Elevated Structures*, Bolt Beranek and Newman, Inc., for U.S. DOT/UMTA (July 1982).
 26. Conversation with W. Jehle of the NYCTA (1994).
 27. Remington, P. J., Wheel Squeal and Impact Noise: What Do We Know? What Don’t We Know? Where Do We Go from Here, *Journal of Sound and Vibration*, Vol. 116, No. 2 (July 1987), pp. 339-354.
 28. Personal observations by the author at the MBTA Green, Blue and Red Lines, July 20, 1995.
 29. Nelson, J. T., Wheel/Rail Noise at the Sacramento Regional Transit System, TCRP Project C3 Technical Memorandum, May 16, 1995, Pg. 23.
 30. Staiano, M. A., and G. Sastry, *Rail Transit Car Wheel Squeal Noise Control*, Paper presented at the Transportation Research Board 69th Annual Meeting, January 7-11, 1990
 31. Zarembski & Bohara, *Controlling Rail and Wheel Wear on Commuter Operations*, Bulletin of the AREA
 32. Wilson G. P., Noise and Vibration Characteristics of High-Speed Transit Vehicles, Technical Report by Wilson, Ihrig & Associates, Inc. For U.S. DOT, Report No. OST-ONA-71-7 (June 1971).
 33. Wilson, G. P., *Noise Levels from Operations of CTA Rail Transit Trains*, Prepared for Chicago Transit Authority by Wilson, Ihrig & Associates, Inc. (May 1977).
 34. “Riflex Comes to North America,” *Modern Railroads*, p. 52 (July 1985).
 35. Leykauf, G., “Wear Behavior of Riflex-Rails and its Effect on Wheel Wear,” *Nahverkehrs-Praxis* (August 1985).
 36. Abbot, D. J., *Rail/Wheel Noise: A Rolling Stock Manufacturer’s Perspective*, ABB Transportation, Ltd, UK (1993).
 37. Hutchings, I. M., *Tribology: Friction and Wear of Engineering Materials*, Ann Arbor: CRC Press, pp. 38–40 (1992).
 38. Staiano, M. A., and G. Sastry, *Rail Transit Car Wheel Squeal Noise Control*, Paper No. 890745, presented at the 69th annual meeting of the Transportation Research Board, Washington, D.C., January 7-11, 1990.
 39. Daniels, E., *Rail Transit Corrugations*, Maryland Mass Transit Administration, for U.S. DOT/UMTA, FTA-MD-06-0141-93-1, p. 30.
 40. Discussion with G. Donaghey of MBTA Engineering and Maintenance Department, July 20, 1995.
-

CHAPTER 9 WAYSIDE TREATMENTS

- 9.1 Introduction, 175
- 9.2 Sound Barrier, 175
 - 9.2.1 Source-Receiver Path, 175
 - 9.2.2 Sound Barrier Attenuation Prediction, 175
 - 9.2.3 Absorptive Sound Barriers, 177
 - 9.2.4 Practical Design Considerations, 177
 - 9.2.5 Case Studies, 178
 - 9.2.6 Source Height, 178
 - 9.2.7 Berms, 179
- 9.3 Subway Wall Treatment, 179
- 9.4 Acoustical Treatment of Stations, 179
 - 9.4.1 Design Guidelines, 180
 - 9.4.2 Materials, 180
 - 9.4.3 Mounting, 181
 - 9.4.4 Treatment Locations, 181
 - 9.4.5 Example of Typical Station Treatment, 181
 - 9.4.6 Sound Barriers, 182
 - 9.4.7 Treatment Effectiveness, 182
 - 9.4.8 Underplatform Treatment, 183
 - 9.4.9 Mezzanine, Entrance, and Corridor Treatments, 184
 - 9.4.10 Other Design Considerations, 185
- 9.5 Fan and Vent Shaft Treatment, 185
 - 9.5.1 Procedures for Attenuating Vent Shaft Noise, 185
 - 9.5.1.1 Straight Ducts, 186
 - 9.5.1.2 Lined Bends, 187
 - 9.5.1.3 Plenums, 190
 - 9.5.1.4 Vent Shaft Entrances, 191
 - 9.5.1.5 Fan Attenuators, 192
 - 9.5.1.6 Fan Rooms, 192
 - 9.5.2 Fan and Vent Shaft Noise Prediction, 192
 - 9.5.3 Sound Absorbing Materials, 194
 - 9.5.3.1 Spray-On Materials, 195
 - 9.5.3.2 Glass-Fiber Boards and Blankets, 195
 - 9.5.3.3 Cellular Glass Blocks, 196
- 9.6 Receiver Treatments, 196
- 9.7 References, 196

This page left intentionally blank.

CHAPTER 9

WAYSIDE TREATMENTS

9.1 INTRODUCTION

Wayside treatments and structure treatments are applied separately of the vehicle, and trackwork, and include sound barriers, open cuts, tunnel wall sound absorption, station treatment, and receiver sound insulation. Each of these treatments is discussed below in respective sections.

9.2 SOUND BARRIER

A sound barrier is any solid obstruction which blocks the line-of-sight from a sound source to a receiver, and is one of the most effective noise control treatments after other treatments such as rail grinding and wheel truing, resilient wheels, and lubrication, are included in the design. Well-designed vehicle and track systems nevertheless produce wayside noise, and, because of close proximity of residences or other sensitive receivers, a sound barrier may be required to provide additional noise reduction over that provided by onboard and trackwork treatments, as well as provide a visual barrier between residential properties and a transportation corridor. Examples of sound barriers include concrete block or powder-coated sheet metal walls erected at the right-of-way line, or, preferably, at about 9 to 10 ft from the track center, and aerial structure mounted panels. Existing topography, earth berms, depressed rail corridor cuts, the edge of an aerial structure, and buildings can act as sound barriers. Barriers are commonly bare, without sound absorption; these are the least costly and most easily maintained. Absorptive barriers are used in special situations where barrier height must be limited, or where the geometry of the vehicle and barrier is such that sound absorption might be effective in controlling reflections, such as on an aerial structure. Sound barriers are most effective if placed close to the track or close to the receiver.

9.2.1 Source-Receiver Path

The sound attenuation provided by a barrier is not generally significant unless the sound source is blocked from the receiver's view. Once the direct path from source to receiver is blocked, the only remaining sound paths are

- Over the top of the barrier,
- Directly through the barrier, or
- A reflected path over the barrier.

The amount of sound energy that passes over the barrier can be reduced by increasing barrier height and length. The sound that passes directly through the barrier can be reduced to a sufficient level with essentially any wall material that has the structural integrity to stand by itself. As a general rule, a surface density of 4 lb/ft² is sufficient (*I*). Barrier design should minimize reflected sound from surfaces that direct sound over the barrier.

9.2.2 Sound Barrier Attenuation Prediction

Figure 9-1 shows the barrier source-path-receiver relationship. The wheels and rail are the sound source, the direct path to the receiver is indicated as *C*, and the diffracted path over the barrier is indicated as *A* and *B*.

The acoustical performance of a barrier is represented by its insertion loss for each octave band frequency. The insertion loss, at a given receptor location, is the difference in the octave band sound pressure levels before and after the barrier is “inserted” (constructed):

$$IL_{\text{barrier}} = L_{p(\text{before})} - L_{p(\text{after})} \text{ dB}$$

This definition of barrier performance avoids the ambiguity which arises because the barrier, besides introducing attenuation due to diffraction, also reduces the attenuation due to the ground by increasing the height of the ray path above the ground. The effect of ground attenuation is often ignored for distances less than 100 ft between track center and receiver to obtain a conservative estimate of insertion loss. The following section uses the terms “insertion loss” and “attenuation” interchangeably, even though “insertion loss” has the more precise meaning.

Predictions of attenuation achieved with a barrier are based on the path length difference between the direct path and the diffracted path, assuming a characteristic spectrum of noise. Detailed calculations are made for each octave or 1/3-octave band, based on the Fresnel Number associated with the band center frequency and path length difference. Given the source, barrier, and receiver geometry illustrated in Figure 9-1, the path length difference is

$$D = A + B - C \tag{Eq. 9.1}$$

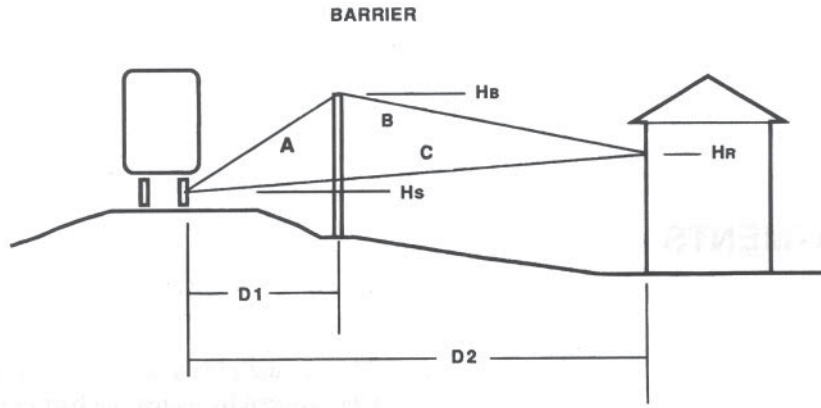

FIGURE 9-1 SOUND BARRIER SOURCE-PATH-RECEIVER RELATIONSHIP

where

$$A = ((H_B - H_S)^2 + D_1^2)^{1/2}$$

$$B = ((H_B - H_R)^2 + (D_2 - D_1)^2)^{1/2}$$

$$C = ((H_S - H_R)^2 + D_2^2)^{1/2}$$

H_S = Source Height
 H_B = Barrier Height
 H_R = Receiver Height

The distance, $(A + B)$, is the shortest path over the barrier's top edge from the source to the receiver and C is the direct distance through the barrier from the source to the receiver. For rail transit systems, the source is usually assumed to be at axle height (1.5 ft above the rail) at the near rail or the track center line, though detailed octave band calculations could consider source heights as a function of octave band.

The following formula for theoretical point-source barrier insertion loss (2) has been used in many sound barrier prediction methodologies:

$$IL = (20 \text{ Log } (2pN)^{1/2} / \tan h (2pN)^{1/2}) + 5 \text{ dB for } N \geq -0.2, 0 \text{ otherwise} \quad \text{Eq. 9.2}$$

where

- $N = \pm 2/\lambda (P)$
- λ = wavelength of sound, m
- d = straight-line distance between source and receiver, m
- P = Path-length difference
- +sign = receiver in the shadow zone
- sign = receiver in the bright zone

For an incoherent line source, such as a moving train, the barrier insertion loss becomes (3)

$$IL = -10 \log [1/\Delta\alpha 10^{-(IL_{point}/10)}] \quad \text{Eq. 9.3}$$

where

$\Delta\alpha$ is the aspect angle of the closest part of the line source. The barrier insertion loss for an incoherent line source includes the effect of directivity of sound radiation. Rail tran-

sit noise radiation has been shown to follow a dipole radiation pattern (4,5). The effect of the dipole radiation pattern is to reduce the contribution of noise from portions of the track at large angle of incidence relative to the track, compared with the contribution from portions of the track immediately opposite the receiver.

For a given path length difference, the barrier insertion loss is a function of frequency. Barriers are more effective at controlling high-frequency, short-wavelength sound than low-frequency, long-wavelength sound. Based on a typical frequency spectrum for rail transit noise, equations can be developed to calculate insertion loss as a function of path length difference specifically for transit systems.

Figure 9-2 presents curves that illustrate insertion loss based on various assumptions. The top curve is a theoretical curve based on Equations 9.2 and 9.3, ignoring the effect of directivity. The theory predicts 5 dBA attenuation even for very small path length differences; however, this cannot be depended upon for field installations, and is usually ignored in practical situations. For example, the 5 dB attenuation at grazing incidence is due to interruption of the line of site between the reflected image source on a hard surface and the receiver. For typical transit systems, there is usually no reflected image due to absorption by existing ballast or ground cover. Similarly, transit systems on aerial structures do not produce a significant virtual image source due to shielding afforded by the edge of the structure. An elevated receiver, looking down on an aerial structure with direct fixation track, would observe a virtual image of wheel rail noise reflected from the aerial structure deck. Similarly, a virtual image would exist for embedded track, for which the 5 dB attenuation at grazing incidence would apply. The following equation is suggested for use with non-absorptive transit barriers (6).

$$IL = \text{MIN}[12 \text{ or } 5.3 \log(P) + 6.7] \quad \text{Eq. 9.4}$$

Figure 9-2 presents examples of measured barrier insertion loss for several field installations. One example is the

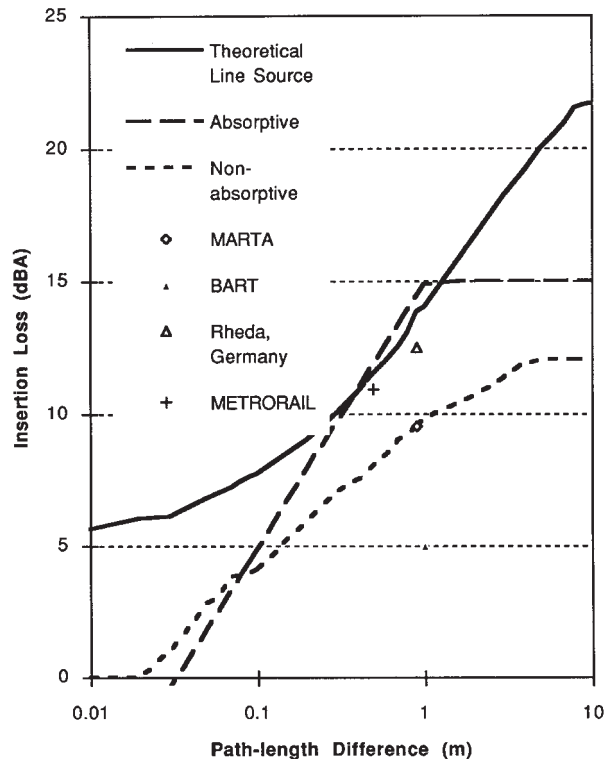

FIGURE 9-2 SOUND BARRIER INSERTION LOSS FOR RAIL TRANSIT SYSTEMS

measured insertion loss for barriers on a MARTA elevated structure. As indicated in Figure 9-2, the theoretical insertion loss curve overestimates the insertion loss achieved with the MARTA aerial structure barriers. Equation 9.4 was developed to reflect the attenuation measured at MARTA. Using this equation will result in a conservative barrier design which will be effective over a wide range of meteorological conditions. Since wind, thermal gradients, and other conditions can significantly change the performance of a barrier, the theoretical curve defined by Equations 9.1 and 9.2 should not be used directly for design purposes.

9.2.3 Absorptive Sound Barriers

The following equation has been developed to account for the improved insertion loss provided by barriers with sound absorptive material on the side of the barrier facing the tracks (7):

$$IL = \text{MIN}[15 \text{ or } 10 \log(P) + 9.7] \quad \text{Eq. 9.5}$$

As can be seen in Figure 9-2, the insertion loss calculated from Equation 9.5 approaches the theoretical line source curve for path length differences between 0.3 and 1 m. However, experimental data do not indicate that absorption is as

effective as predicted by Equation 9.5. On ballast-and-tie track, for example, there is already substantial absorption provided by the ballast, and the additional absorption applied to the barrier may have a limited effect. On aerial structures with direct fixation track and closed decks, addition of absorption to the trackside surface of the aerial structure sound barriers is usually assumed to provide about 3 dB additional insertion loss.

Transit system barrier insertion loss predictions become more complicated in actual barrier designs. For example, the equations given above are for infinitely long barriers; not for finite length barriers. Because noise radiation from a rail transit vehicle has a dipole radiation pattern, the prediction of barrier performance with the infinite barrier assumption is usually adequate for maximum sound levels. However, if energy equivalent noise levels are to be considered, as recommended by the Federal Transit Administration (8), then the overall passby signature must be considered, which places greater demand on barrier calculations.

Some designers have attempted to use the FHWA STAMINA 2.0 computer model for rail transit noise prediction, employing *ad hoc* noise emission levels developed for transit vehicles. STAMINA assumes a monopole radiation pattern in design, so that it is not entirely appropriate, though the results are reasonably accurate within a few decibels and adequate for design. STAMINA may over-predict noise levels to some extent.

9.2.4 Practical Design Considerations

Despite the problems associated with applying complex theoretical models of sound barrier insertion loss, adequate barrier design can be developed following relatively simple design principles. A general rule of thumb is that 5 dBA attenuation is relatively easy to obtain; 10 dBA attenuation can be achieved with careful attention to the barrier design; and 15 dBA is usually the physical limit in field installations of barriers, although it is difficult to achieve with practical designs. Barrier theory indicates that attenuations up to 25 or 30 dBA can be achieved, and laboratory experiments have generally proved the validity of the theory. However, the theory does not include the effects of temperature variations, air turbulence, ground effects, reflections, and incoherent line sources, all of which act to reduce the effectiveness of barriers. The following are design guidelines:

- The barrier must break the line-of-sight path between the noise source and the receiver and block all possible sound propagation paths from the source to the receiver.
- Open areas in the barrier, such as maintenance access ports, for example, should be kept as small as possible. They provide flanking paths for the sound to “short circuit” the barrier.
- The barrier should be constructed of a material that is sufficiently heavy to control the transmission of sound

through the barrier. In most cases, virtually any material that is sufficiently strong to withstand wind loads and provide structural support will also be sufficiently massive to control sound transmission through the barrier.

- Barriers must block both the direct path and any reflected paths between the source and the receiver.
- The most effective location for barriers is either close to the noise source or close to the receiver.

In almost all cases, these basic guidelines will result in a barrier with 5 to 8 dBA attenuation. To obtain greater attenuation, more care must be taken in the design of the barrier.

9.2.5 Case Studies

Shown in Figure 9-2 are the attenuations that were achieved with barriers on aerial structures at BART and MARTA. As discussed previously, the nonabsorptive insertion loss curve was developed to reflect the MARTA insertion loss data. In contrast, the BART barriers are 4 to 5 dBA less effective than predicted by the nonabsorptive insertion loss curve, due to a gap between halves of the elevated structure and, to a lesser extent, a gap at the bottom of the barrier. Measurements of the BART barriers with the gap at the bottom plugged by rubber gasketing material reduced the wayside noise levels further by 1 to 2 dBA, illustrating the importance of designing barriers with minimal openings.

Sound insertion loss measurements were conducted for barriers constructed on an elevated structure of the Miami Dade County Metrorail system. (9) The goal of the insertion loss measurements was to determine the effect of sound absorption material on the side of the barrier facing the tracks, and the effect of filling a 1- to 2-in. gap between barrier panels at each pier and a 1-in. gap at the junction of the barrier and the guideway. The measurements indicated insertion losses of 8 dBA with no sound absorption treatment, 9 dBA with barrier/guideway gap sealed, 10 dBA with barrier/guideway and barrier panel gaps sealed, and 11 dBA with all gaps sealed and sound absorption treatment. That is, the sound absorption treatment provided approximately 1 dBA of benefit at rail height. The measurements also indicated 3 dBA of benefit at a receiver height higher than the top of the barrier, suggesting that sound absorption material is only of significant benefit in the case where receptor locations are above the barrier top. Recent discussions with the Miami Metrorail staff indicate that these barriers were dismantled because of the degradation due to weather of the sheet metal barrier material and absorptive material. The Metrorail insertion loss data for absorptive barriers are shown in Figure 9-2 and are in close agreement with the absorptive barrier design curve.

A rail barrier insertion loss measurement program in Germany was conducted with intercity trains to determine the effects of various barrier top configurations (10). The barrier tops included a standard vertical wall, a slant-top, and a

y-top. For a 2-m high absorptive barrier 3.8 m from the track centerline, 13 dBA attenuation is reported. This value is also shown on Figure 9-2 for comparison with the absorptive barrier design curve. For a slant-top absorptive barrier, 14 dBA attenuation is reported. The y-top absorptive barrier achieved 16 dBA attenuation. Barrier insertion loss generally increases with increasing width or complexity of the barrier top. However, the cost of a barrier with a complex top is generally equivalent to a taller conventional barrier with equivalent insertion loss. One may conjecture that the improved performance of the y-top barrier is due to locating the crown of the barrier closer to the source, thus increasing the source-receiver path-length difference.

Another example of a nonstandard barrier top design is cylindrical absorber-topped barrier. The barrier consists of a vertical wall with a cylinder of sound absorptive material along the top. This type of barrier is being used in Japan to shield residents from highway noise. Insertion loss measurements show that these barriers can be 1.5 to 2 m lower than an acoustically equivalent conventional barrier. The cost of these barriers is expected to be approximately the same as a higher conventional barrier with equivalent insertion loss.

9.2.6 Source Height

Source heights can be considered in detailed calculations of sound barrier insertion losses for individual 1/3- or 1/1-octave bands, using the Fresnel Number in the calculations, and more complex formulas than those provided for single-number (for example, A-weighted sound level) determinations. However, source heights are difficult to define, though there are some isolated literature which shed light on source height as a function of frequency.

Barsikov et al. (1987) has measured source heights for trued wheels on smooth ground rail to be about 0.2 m above the top of rail for frequencies in excess of about 1,000 Hz for high-speed trains. With a damping treatment applied to the face of the wheel center to damp resonances in the wheel, the source heights are reduced to the top-of-rail, consistent with assuming that the rail is the dominant radiator. Beguet et al. (1988) provided data on source heights for low speed trains of 60 and 100 km/hr. At 250 Hz, the source location is prominent at the center of the wheel, though one must remember that the wavelength of sound at 250 Hz is about 4 ft, larger than the diameter of the wheel, so that localizing the source at the center of the wheel may not be subject to interpretation. At the 500 and 1,000 Hz octaves, the source appears to be concentrated at the wheel/rail contact point. At 2,000 Hz, the source appears to be distributed over the surface of the wheel, and is believed to be related to the modal behavior of the wheel.

Sources were investigated at the Deutsche Bundesbahn in Europe (11) and the results of these studies indicate

- The main sound source is the wheel disc at frequencies above 1,600 Hz.
- Between 500 and 800 Hz, the truck frame appears to be most important. (This may not be directly applicable to rail transit systems at lower speeds than those of the Deutsche Bundesbahn which produce substantial air turbulence in the region of the truck).
- The rail does not appear to be a significant source of noise over the important frequency range of noise radiation, though when the ties and ballast are included, the rails may dominate at frequencies less than 250 Hz.
- The car body is not a significant source of noise.

Tests at the SNCF indicate that the running gear, as apposed to the rail and car body, is the major source of noise in the 500, 1,000, and 2,000 Hz octave bands for various railroad vehicles (not transit). The definition of running gear was not provided, but is assumed to include the wheels, gearbox, and motor (12). These data suggest that a reasonable source height for barrier calculations is that of the axle center.

For practical design calculations, the source should be assumed to be at the axle elevation, over the near rail. This will produce conservative estimates of insertion loss, and will result in over design of the barrier by, at most, about 1.5 ft. However, the assumption of source at axle height for wheel squeal is not necessarily conservative, because much of the noise energy is radiated by the wheel.

9.2.7 Berms

Berms are an attractive alternative to sound barrier walls. Further, berms appear to provide additional sound absorption over walls of equivalent height. The reason is conjectured to be the sound absorption afforded by the ground cover, which is usually grass, ivy, or some other foliage providing resistance to erosion. However, the width of the berm crown also increases the path length difference, which may have some effect. The California Department of Transportation assigns an additional 3 dB to the noise reduction afforded by an equivalent height wall. For prediction purposes, the conservative approach would be to ignore the additional insertion loss due to absorption. Regardless of the noise reduction performance of berms *vis-a-vis* walls, berms are often more visually attractive than walls. Berms require greater footprints, however, to maintain slope stability, though certain “geo-cloths” or retaining structures can be employed. The smaller footprint of a wall relative to that of a berm often makes the wall the more practical alternative.

9.3 SUBWAY WALL TREATMENT

Vehicle interior noise is an important factor in wheel/rail noise control, particularly in subways. Noise reductions can be readily achieved in subways by treating the subway walls

and ceiling with sound absorbing materials. The only systems where this has been done extensively are the Boston MBTA Red Line and the Toronto Transit Commission, where 1 to 2 in. of spray-on cementitious acoustical treatment were applied. Without treatment, the only absorption available is that due to the concrete subway walls, ballast (if part of the trackwork), the vehicle, and radiation losses up and down the tunnel away from the train. Subways with ballasted track would not benefit from subway wall treatment as much as those with concrete inverts and direct fixation track, because the ballast provides some sound absorption.

The noise reduction can be estimated on the basis of the effective length of the train which may be considered as a sound source for a particular receiving vehicle. That is, with treatment, the most significant sound source is the vehicle in which a receiver is riding. Without treatment, the receiving vehicle and 2 to 4 more vehicles may be considered as sources. Thus, treatment may reduce the effective source length of the train to that of a single vehicle. For a 10-car train, the noise reduction provided by the treatment would be on the order of 7 to 10 dB, while for a single-car train, the noise reduction would be less, because much of the noise energy is radiated up and down the tunnel away from the vehicle. Still, the noise reduction achieved with subway treatment might be on the order of 3 dB for a single vehicle.

The cost for subway wall cementitious sound absorption is on the order of \$7 to \$10 per square ft, depending on quantity, labor rates, and ease of installation. As a practical matter, only the upper half of the subway wall and all of the ceiling may be treated, so that the cost per lineal foot will be about \$180 to \$260 per lineal foot.

9.4 ACOUSTICAL TREATMENT OF STATIONS

Transit system designers have often used acoustically reflective materials, such as painted concrete or ceramic tile, on all surfaces of train platform areas, for durability, abuse resistance, and ease of cleaning. With these materials, train noise is not dissipated, resulting in a reverberant and noisy space. Wheel/rail noise may be reduced in transit system stations by applying sound absorbing materials to exposed surfaces. Acoustical treatment of the walls and ceilings prevents excessive build-up of reverberant sound energy, substantially reduces train, ventilation equipment, and crowd noise, and greatly improves the intelligibility of public address systems, an important factor in station design. Most new subway stations in the United States are acoustically treated, examples of which include stations at BART, WMATA Metro, MARTA, Baltimore Metro, NFTA (Buffalo), TTC, MTA NYCT, Chicago CTA, and LA Metro.

The type and placement of acoustical lining determine treatment effectiveness. There is a wide assortment of acoustically absorptive materials, and the choice of the appropriate material is based on the amount of required

absorption, architectural considerations, ability to withstand train movement induced pressure transient loading and buffering in stations, resistance to mechanical abuse, safety considerations such as flame resistance, cost, and other considerations. In most cases glass fiber products are the most economical treatment. However, there are many other products that should be considered, such as spray on cementitious sound absorption.

Barriers may be used between the tracks to block sound from trains passing through stations. This type of treatment has been used in New York, though there are concerns regarding safety. As a rule, this type of treatment would be less needed if the trainway ceiling and station walls and ceiling were treated with acoustical absorption, and if the rails and wheels were maintained in good condition.

9.4.1 Design Guidelines

The APTA Guidelines include design goals for maximum levels of station platform noise, and are summarized in Table 9-1. As long as the noise created by the trains is consistent with the APTA Guidelines for wayside passby noise, then following the guidelines for treatment of walls and ceilings in platform areas as listed in Table 9-2 will ensure that the design goals for station noise levels are achieved.

The design guidelines in Table 9-2 are based on an efficient use of materials. The recommended sound absorption treatment will control reverberation and train noise efficiently. Further noise and reverberation control is possible by using greater amounts of treatment, but doubling the amounts would have only a small additional effect on the acoustical environment, and would not justify the added cost. Thus, the use of sound absorbing materials is to some extent governed by the law of diminishing returns; beyond a certain point additional treatment becomes uneconomical and inefficient, and other noise control procedures should be considered.

9.4.2 Materials

A number of treatment configurations are available for the ceilings and walls of the train rooms. Glass fiber is one of the most efficient and inexpensive sound absorbing materials available. Absorption coefficients for various thicknesses of glass fiber board are presented in Table 9-3. Table 9-4 indicates some of the representative sound absorbing materials used for treatment of stations. Materials equivalent to the glass fiber products listed in Table 9-4 should be given equal consideration. The last two materials listed in Table 9-4 are appropriate only where flammable materials are acceptable.

TABLE 9-1 DESIGN GOALS FOR PLATFORM MAXIMUM NOISE LEVELS

CONDITION	LEVEL - DBA
Trains Entering or Leaving	80-85
Trains Passing Through Station	85
Trains Stationary	68

TABLE 9-2 DESIGN CRITERIA FOR ACOUSTICAL TREATMENT OF STATION PLATFORM AREAS TO CONTROL TRAIN NOISE

Maximum Reverberation Time	500 Hz	1.5 sec.
Treatment Area	Wall and Ceiling	35% (1)
	Under Platform Wall and Overhang	100%
Ceiling and Wall Treatment Properties	Minimum Absorption Coefficient at 500 Hz	0.6
	NRC	0.6
Under Platform Treatment Properties: Minimum Absorption Coefficient (3 to 4 In. Thickness)	250 Hz	0.4
	500 Hz	0.65

TABLE 9-3 TYPICAL SOUND ABSORPTION COEFFICIENTS TO BE EXPECTED FROM GLASS-FIBER SOUND ABSORBING MATERIALS MOUNTED DIRECTLY AGAINST A CONCRETE SURFACE

FREQUENCY - HZ	125	250	500	1,000	2,000
1 In. Thick Glass Fiber	0.08	0.30	0.65	0.80	0.85
2 In. Thick Glass Fiber	0.20	0.55	0.80	0.95	0.90
3 In. Thick Glass Fiber	0.45	0.80	0.90	0.95	0.90

TABLE 9-4 SOUND ABSORBING MATERIALS FOR CONSIDERATION FOR ACOUSTICAL TREATMENT OF STATIONS

MATERIAL		APPROXIMATE ABSORPTION COEFFICIENT WITH RIGID BACKING	
		250 HZ	500 HZ
4 In. Thick Geocoustic Block 1 x 1.5 Ft Slotted	Unspaced	1.0	1.06
	Spaced 2 In. Both Directions	0.90	1.06
	Spaced 6 In. Both Directions	0.60	0.66
4 In. Thick Geocoustic Block 1 x 1.5 Ft Perforated	Unspaced	0.79	0.84
	Spaced 2 In. Both Directions	0.82	0.94
	Spaced 6 In. Both Directions	0.53	0.59
0.842 In. Thick Geocoustic block 1 Ft x 1.5 Ft Perforated	Unspaced	0.79	0.73
	Spaced 2 In. Both Directions	0.74	0.71
	Spaced 8 In. Both Directions	0.42	0.60
2 In. Thick Glass Wool of 2 to 6 pcf wrapped with glass cloth		0.60	0.80
2 In. Thick Owens-Corning Aeroflex Duct Liner 3 pcf or Type 702 board faced with vinyl or neoprene		0.55	0.80
2 In. Thick Owens-Corning Type 703, 704, or 705 Board Faced with Glass Cloth		0.55	0.85

9.4.3 Mounting

Sectioned or continuous panels (consisting of either a metal or plastic slit-and-slat system or a perforated metal facing) with fiberglass or cellular glass blocks between the facing and the concrete surface are appropriate for treating flat, continuous surfaces and platform or mezzanine ceiling areas. In trainway areas, if a continuous panel system is assembled such that there exists an air gap between the back of the panels and the concrete backing (panels furred away from the walls), or a suspended acoustical tile ceiling is used, gaps or openings must be provided around the panel edges or elsewhere to permit free air flow to the region behind the panel. If pressure equalization provisions are not provided, the loading due to air pressure transients can eventually cause fatigue failure of the fastenings, allowing the panels to come loose from the mounting surface and fall, possibly injuring personnel and patrons. Trainway acoustical treatment in station areas should be designed to withstand air pressure transient loadings of about 15 psf.

Panels with perforated metal or slit-and-slat facings — in underplatform, ceiling, and wall installations — should have a dimpled screen placed between the metal facing and the face of the acoustic blanket to establish an airspace of about 1/2-in. thickness between the perforated facing and the blanket or glass-cloth bag. This airspace serves two purposes: (1) it allows the sound waves to diffuse over the entire face of the acoustic material, thereby assuring full efficiency as a sound absorber; and (2) it allows free airflow for pressure equalization, thus preventing loading of the facing by air pressure transients produced by the train.

Note that several combinations of spaced and unspaced Geocoustic Blocks are listed. The absorption coefficients for the spaced configurations are based on the gross area of the

treatment, i.e., the block area plus the area of the spaces between blocks. Use of spaced configurations can result in material economy, but to avoid loss of low-frequency absorption, the 4-in. thick units should be spaced not more than 6 in. apart and the 2-in. thick units not more than 4 in. apart. For lowest cost and nonflammability, Geocoustic Blocks should be specified unpainted, and without surface coating or wrapping.

9.4.4 Treatment Locations

Provision of sound absorbing materials is appropriate in subway stations at underplatform areas, platform walls and ceilings, and in enclosed concourse spaces such as fare collection areas, stairs, escalators and corridors. Similarly, enclosed areas of above-grade stations should have ceiling- and wall-mounted absorption treatment to create an attractive acoustic environment for transit patrons. Fortunately, the platform areas of most surface stations are only partially enclosed, thus reducing reverberation and noise, and additional acoustical treatment to control reverberation is generally not needed in surface station platform areas or other spaces with large openings to the outdoors. However, sound absorption should be considered for the underside of canopies to control reflected train noise beneath the canopy. The absorption can be particularly important when the station platform is located in a highway median and patrons are exposed to high levels of highway traffic noise (13).

9.4.5 Example of Typical Station Treatment

Figure 9-3 presents an example of an acoustically treated subway station. The figure illustrates the use of a platform

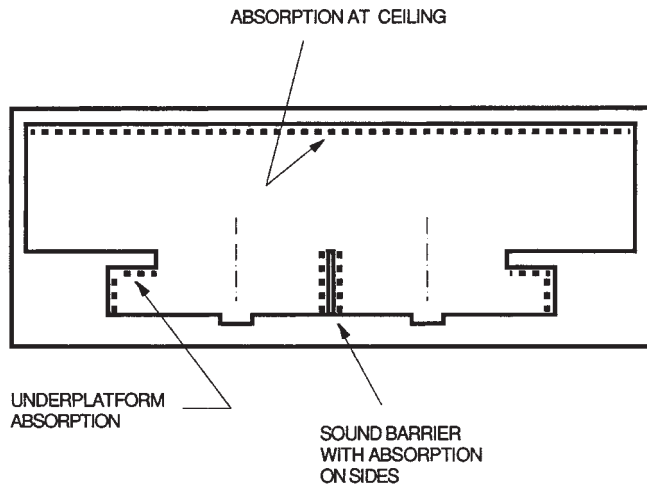

FIGURE 9-3 ACOUSTICAL TREATMENT OF STATION PLATFORM AREAS

height sound barrier to control train noise and appropriate locations for acoustical absorption. The noise sources on a transit car are primarily located in the confined space beneath the transit cars. Sound absorbing materials located on the trackbed or on the walls of the underplatform areas effectively absorb sound energy close to the source, and reduce the level of train noise on the station platform. The underplatform acts as an acoustically lined plenum when the train is in place, and is thus very effective in controlling noise, especially with between-track platforms. For double track configurations with platforms on either side of the tracks, the plenum noise reduction is only effective for noise produced by the wheels and rails located adjacent to the platform.

9.4.6 Sound Barriers

On side platform stations, further reductions can be achieved by using absorptive sound barriers to block noise from far track trains. Barriers only need to be as high as the platform level to achieve significant reductions of train noise, because wheel/rail noise originates beneath the cars. Sound absorption should be provided on both sides of the barrier where direct fixation track is employed. Without sound absorption, there would be little reduction of noise. For ballasted track, the ballast provides substantial absorption, and there is no need for absorption to be applied to the barrier. A platform height barrier between the near and far tracks of a side platform station can reduce sound levels on the platform by as much as 10 dBA (14). The actual amount of reduction is dependent on the design of the barrier and the measurement location. The greatest reduction occurs on the far platform, where the wheels and rail would otherwise be in full view of patrons, but there is also some reduction on the near platform.

9.4.7 Treatment Effectiveness

Figure 9-4 indicates reverberation times measured in WMATA Metro and BART subway stations, before and after installation of acoustical treatment on ceiling and underplatform overhang surfaces. The reverberation times measured in treated BART and WMATA stations are typically 1.3 to 1.5 sec at 500 Hz, as compared with 7 to 9 sec for untreated stations. Train noise levels in acoustically treated stations are much more acceptable than those found in older systems with completely untreated, highly reverberant stations.

Figure 9-5 shows noise levels on the platforms for trains passing by at 40 mph at several subway stations. The noise levels at BART and WMATA platforms are in the range of 87 to 89 dBA. Noise levels in untreated Chicago CTA stations, under similar operating conditions and using similar trains, are as high as 108 dBA on the platform of stations with concrete trackbed and 93 dBA on the platform of stations with ballast-and-tie tracks. The 15 dBA difference due to the ballast confirms that the ballast provides a significant amount of sound absorption which both absorbs sound at the source and reduces the reverberant sound energy build-up.

Noise measurements inside WMATA Metro cars indicate that acoustical treatment of subway stations can substantially reduce car interior noise levels (15). Figure 9-6 shows the results of these measurements. In a box structure with no sound absorption treatment, the interior noise level for a 2-car train operating at 40 mph was 79 dBA, whereas in passing through an acoustically treated station the interior level was 68 dBA. The same type of measurement indicated 64 dBA for at-grade ballast-and-tie stations, where no reflective sound impinges on the transit car.

Figure 9-7 presents typical noise levels, measured in TTC tunnel stations having sound absorption treatment on the underplatform overhang surfaces only (an insufficient amount to control reverberation and allow intelligibility of the public address system), and in a station in which the entire ceiling, as well as the underplatform, has been treated (16). The range shows the typical maximum levels that occur on the station platforms as trains arrive and depart. The sound absorption on the ceiling in this case is provided mainly by a suspended acoustical tile ceiling, an arrangement which gives nearly uniform absorption and noise reduction over the entire frequency range relevant to wheel/rail noise. The effective noise reduction is very dramatic—about 13 dBA.

Figure 9-8 compares noise levels observed in two BART stations: one with underplatform overhang and ceiling treatment, and the second with the ceiling treatment only (17). Both stations had sufficient acoustical treatment to reduce the reverberation time to about the same range, i.e., about 1.3 sec at 500 Hz. However, they were different in that the underplatform surfaces at the Lake Merritt Station had a complete and continuous treatment of 4-in. thick glasswool with a sheet plastic cover, while the 19th Street Station, at the

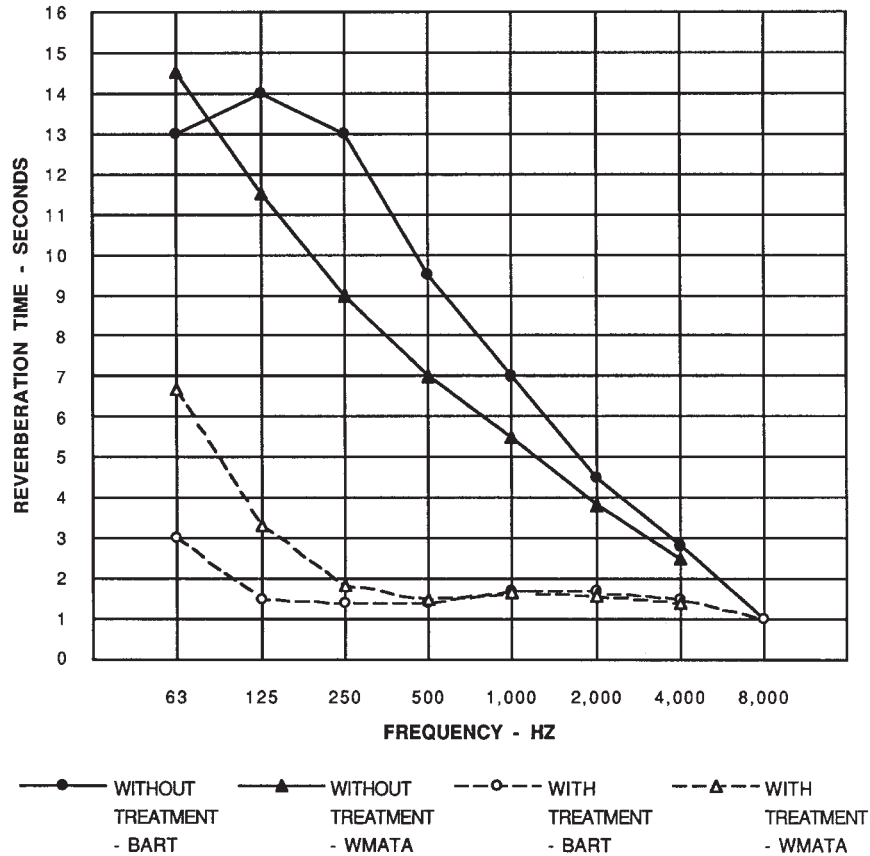

FIGURE 9-4 REVERBERATION TIMES FOR TREATED AND UNTREATED STATIONS

time of measurement, had almost no acoustical treatment under the platform edge; only one row of acoustical tile units spaced at about 0.6 m on center.

Figure 9-8 shows the dramatic effects of treating the relatively small area under the platform (18). In the 19th Street Station, where the underplatform treatment was omitted, the average noise level was about 5 dBA greater; in the middle and low frequencies, the difference in noise level was 5 to 8 dB, illustrating the importance of proper placement of the sound absorbing material. To obtain full benefit from acoustical treatment, continuous treatment must be placed in the underplatform overhang area, including the underside of the overhang and the rear wall beneath the overhang.

9.4.8 Underplatform Treatment

For underplatform overhang treatment, a recommended material assembly is a 3-in. to 4-in. thickness of nonflammable glasswool with an appropriate cover of glass fiber cloth or nonflammable plastic film of not more than 0.004 in. thickness, and a facing of expanded metal or hardware cloth. Cellular glass blocks of 2- to 4-in. thickness are a recommended alternative for underplatform overhang treatment.

The material should be mounted to cover as much of the underplatform area as possible. At stations with significant platform overhangs, sound absorbing material should be placed on the underside of the overhang surface as well as the vertical wall. The minimum treatment for the underplatform area is a 2.5-ft wide strip of continuous treatment on the vertical rear wall surface and complete coverage of the underside of the platform overhang.

If glass fiber wrapped in glass cloth is used for the underplatform treatment, the panels should be held in place with either an expanded metal facing, hardware cloth facing, or perforated metal facing. For center platform stations, expanded metal or hardware cloth is the most economical material since the material is not visible to patrons. For a side platform station, where the material is visible to patrons on the opposite platform, a better appearance can be obtained with perforated metal facing. Perforated metal or slit-and-slat facings should have open areas of at least 10% (1/8-in. diameter holes at 3/8-in. center-to-center) or, preferably, 20% of the total area. Either expanded or perforated metal facings can be attached to the underplatform surfaces with simple metal brackets. The sound absorbing materials and retention hardware must be able to withstand high pressure wash and other cleaning methods that might be employed in subway environments.

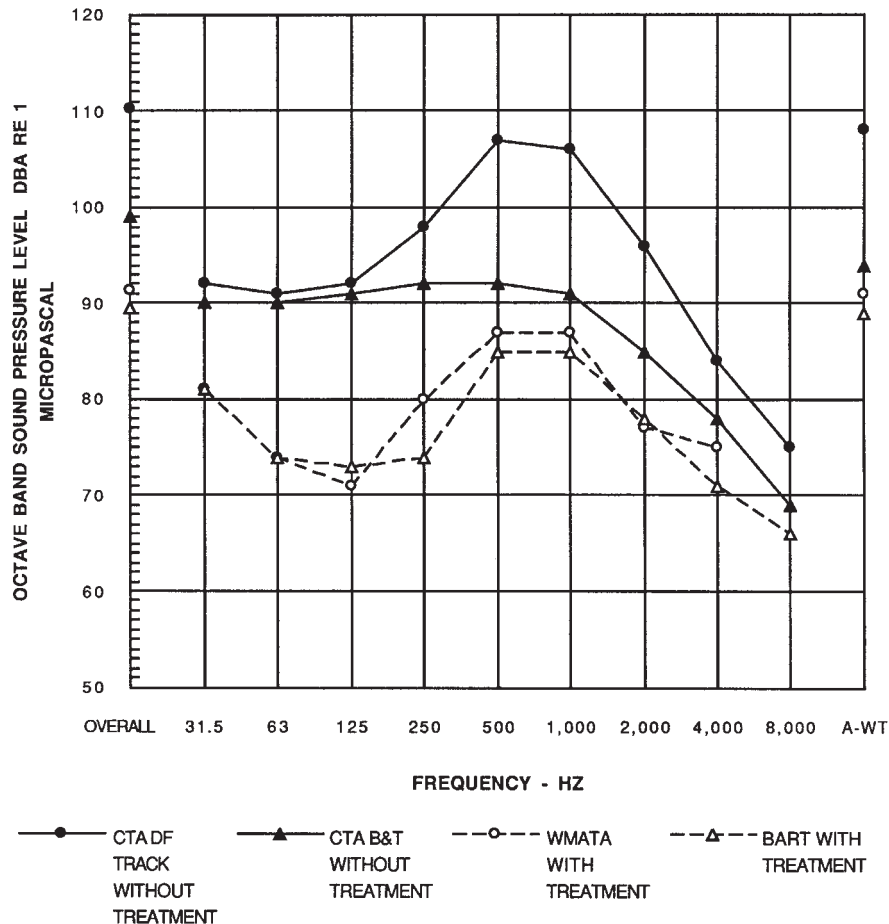

FIGURE 9-5 SUBWAY STATION PLATFORM NOISE LEVELS WITH TRAINS PASSING THROUGH AT 40 MPH

9.4.9 Mezzanine, Entrance, and Corridor Treatments

The design recommended for platform and mezzanine ceilings includes a 2-in. thick layer of glasswool with appropriate covering, and either perforated sheet metal or slit-and-slat configuration facings. A treatment with 1-in. thick glasswool is sufficient in other areas of the stations, such as at entrances, corridors, etc.

A basic panel system for ceilings and walls in the mezzanine and corridor areas can provide acoustical absorption very simply. The panel may be of perforated metal, a slit-and-slat configuration of boards or metal, or some form of architectural trim. The latter design should have at least 20% open area and no bars or sections with width greater than 3 in. between the openings. Such an arrangement will provide a completely transparent acoustical face. Acoustical material can then be located $\frac{1}{2}$ in. to 6 in. behind the face; cellular glass blocks or nonflammable glasswool of 2-in. thickness would be suitable materials. Also, as for mezzanine areas, panels of glasswool blankets with perforated metal facing can be used. A consideration when designing treatment for

mezzanine areas is that, depending on station configuration and ventilation, they may be subject to dust (including brake dust) from the trains.

For areas other than platforms and mezzanines, ordinary acoustical tile or panels of $\frac{3}{4}$ -in. to 1-in. thickness are appropriate. These materials—which may be of compressed glasswool or other appropriate fire resistant cellular material—can be of the type with painted or vinyl facing.

At corridors and entrances, the sound absorption treatment can be the same as that described above for platforms and mezzanines, or it can consist of an application of $\frac{3}{4}$ -in. to 1-in. thick acoustical tile, acoustical ceiling board, or cellular glass blocks. Another choice might be a sound absorption assembly, such as perforated sheet metal with fiberglass blankets behind the sheet metal facing. The absorption coefficient should be at least equal to the value listed in Table 9-2 for each type of space, taking the type of mounting into account.

A suitable covering for any side wall treatment is perforated sheet metal with at least 20% open area. Perforation patterns, such as $\frac{1}{16}$ -in. diameter holes staggered at $\frac{7}{64}$ -in. center, $\frac{1}{8}$ -inch diameter holes at $\frac{3}{16}$ -in. centers, or $\frac{3}{16}$ -in. diameter holes at $\frac{5}{16}$ -in. centers, provide adequate open area.

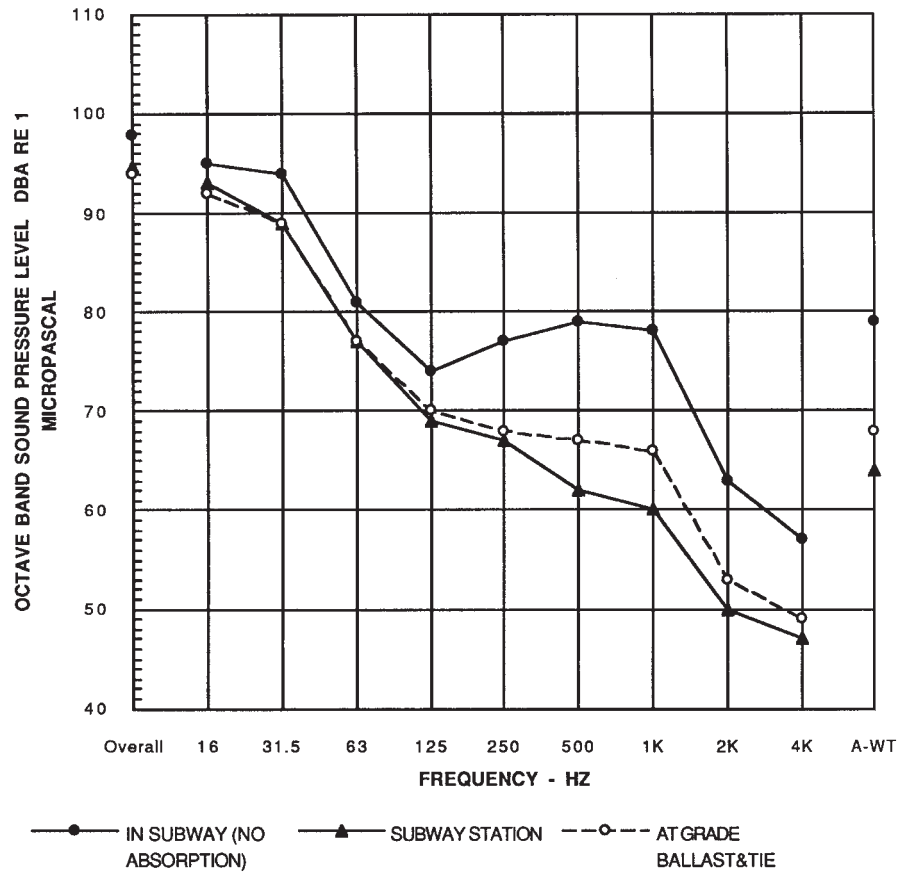

FIGURE 9-6 WMATA METRO CAR INTERIOR NOISE LEVELS, 2-CAR TRAIN AT 40 MPH

There are, of course, other combinations of equivalent performance.

9.4.10 Other Design Considerations

The acoustical design of the station should consider other sources of sound, such as highway and crowd noise, and intelligibility of the public address system. These are discussed in the *Handbook of Urban Rail Noise and Vibration Control* (19).

9.5 FAN AND VENT SHAFT TREATMENT

This section addresses the control of wheel/rail noise transmitted from underground subways to the street above through fans and vent shafts. Noise control treatment provided for controlling ancillary equipment noise, such as fan noise, necessarily will control train noise. Where communities are located near shaft openings, noise control may be required to prevent an increase or at most allow a minor increase in ambient levels in the community.

The APTA Guidelines provide design guidelines for ancillary equipment noise levels. These guidelines are for maxi-

imum noise levels at 50 ft from the facility, at the setback line of the nearest building, or at the nearest occupied area, whichever is nearest to the source. “Transient noise” refers to intermittent noise, such as that caused by trains. The criteria cover a 25 dBA range with the appropriate level depending upon the type of neighborhood in which the facility is located; the criteria are least restrictive for industrial areas and the most restrictive for low density residential areas. Fan and vent shafts located in industrial areas generally do not require any noise control treatments. However, when fan and vent shafts are located in a low density residential area, particular care must be taken to ensure that the noise levels are not excessive.

In most situations, designing transit systems to meet the APTA Guidelines will prevent community annoyance with transit noise. However, local noise ordinances may apply at specific locations, in which case they may take precedence over the transit system design criteria.

9.5.1 Procedures for Attenuating Vent Shaft Noise

Figure 9-9 illustrates the cross-section of a typical fan/vent shaft configuration, and the paths by which noise travels to

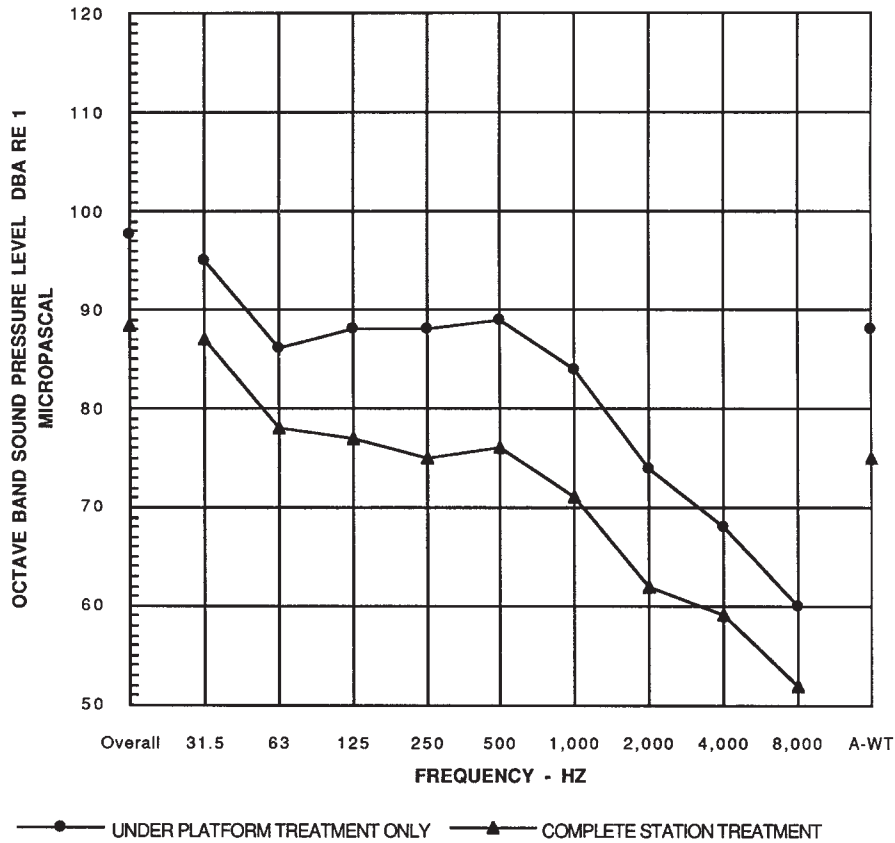

FIGURE 9-7 TYPICAL MAXIMUM PLATFORM NOISE LEVELS OF TTC TUNNEL STATIONS WITH TRAINS ENTERING AND LEAVING

patrons and adjacent communities. Noise from trains and ancillary equipment travels into fan shafts and plenums and radiates outdoors. Without acoustical treatment, the noise can be intrusive in nearby residential or other sensitive areas.

The following basic procedures are available for controlling vent shaft noise:

- Apply acoustical absorption material to surfaces of shafts, tunnel walls, and subway ceilings near vent shafts.
- Attach silencers to fans.

The noise reduction achieved by lining a fan or vent shaft depends on the placement, area to be covered, and type of material used. Noise control provisions such as an inline silencer incorporated to control fan noise will necessarily control train passby noise. Most of the discussion of ventilation shaft noise treatment for wheel/rail noise will thus focus on treatment of wall surfaces with sound absorbing materials. Information on fan shaft treatments to control fan noise may be obtained from the *Handbook of Urban Rail Noise and Vibration Control* (20).

Acoustical absorption in air handling systems can be very effective for controlling wheel/rail noise propagated through the duct system. Attenuation is maximized when treatment is

applied to the surfaces on which the sound energy impinges directly, such as at bends in the shafts. The following discussion is largely based on the ASHRAE Guide which contains more detailed information on the control of noise in ventilating systems (21).

There are three types of areas on which absorption lining can be applied:

- Straight sections of duct,
- Bends in ducts, or
- Plenums.

The least effective treatment is the lining of the walls of straight sections of ducts. Because ducts in vent and fan shafts are usually large, typically 100 sq ft, large amounts of treatment are needed to achieve significant attenuation. Lining bends and plenums, however, can be very effective and economical for reducing noise. Since fan and vent shafts are large, they are most appropriately analyzed as plenums rather than as ducts.

9.5.1.1 Straight Ducts

The exact mathematics of sound propagation in lined ducts are complex. Design calculations are generally based on an empirical formula:

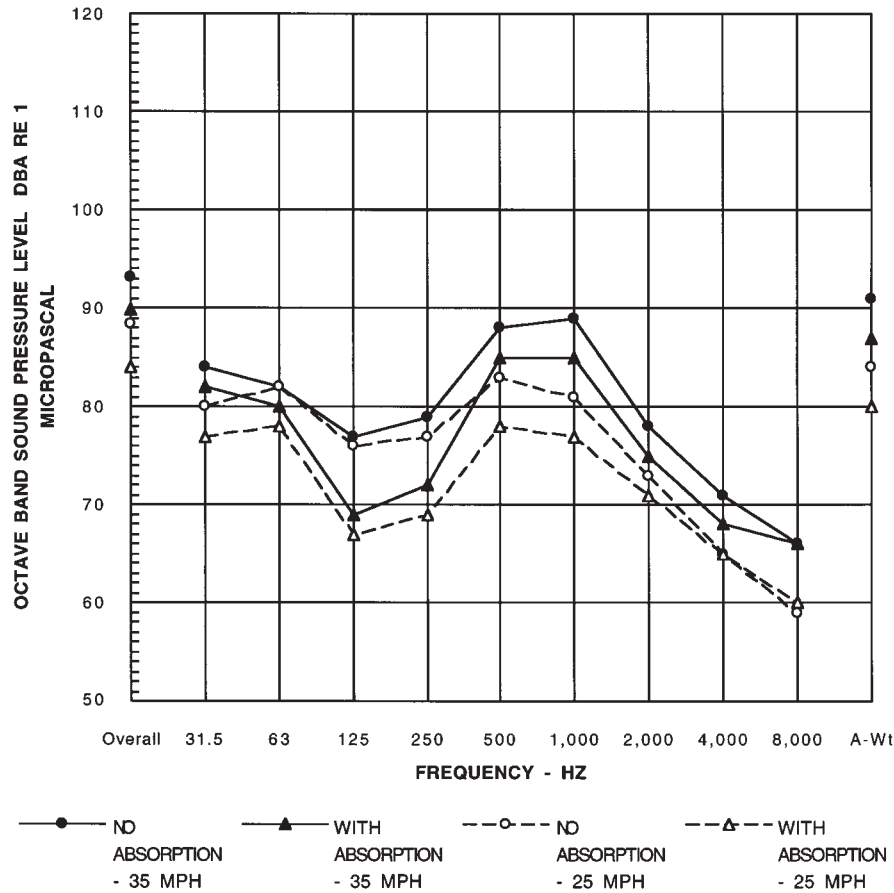

FIGURE 9-8 NOISE LEVELS AT BART SUBWAY STATIONS WITH AND WITHOUT UNDER PLATFORM SOUND ABSORPTION (CEILINGS AND WALLS TREATED IN BOTH CASES)

$$\text{Attenuation (dB)} = 1.05 (dP/A) a^{1.4}$$

where

- d = length of lining
- P = duct perimeter
- A = duct area
- a = average absorption coefficient (a function of frequency)

The values for d , P , and A can be specified in any consistent unit system.

This formula does not account for line-of-site propagation, which limits attenuation at high frequencies. For a duct with a minimum cross-section dimension of about 1 m (3 ft), the maximum attenuation in a straight lined duct is 10 dB in the 2,000 Hz octave band. The attenuation in the 1,000 Hz octave band will be approximately midway between 10 dB and the value calculated from the equation. The frequency above which the 10 dB limit applies is inversely proportional to the shortest dimension of the duct. For a large vent shaft with a minimum dimension of about 10 ft, the 10 dB limit applies to frequencies above approximately 600 Hz. Note that for a

10-sq ft-shaft of cross-sectional area 100-sq ft, lined with 2-in. thick glass-fiber board with an acoustical absorption coefficient of 0.8 in the 500 Hz octave, the formula requires lining nearly 30 ft of shaft to obtain a 10 dB noise reduction. This length, usually not available in typical ventilation shafts, indicates why lining lengths of straight shafts is usually impractical.

9.5.1.2 Lined Bends

Acoustical treatment of ventilation shaft walls and ceilings before and after bends is very effective in reducing noise. The sketch in Figure 9-10 indicates the most effective locations for placing sound absorbing material. The definition of shaft depths, d and D , and shaft width, W , as they apply to sound attenuation treatment in a fan or vent shaft, are also indicated in the figure. Note that the sketch shows acoustical material on only the sides *normal* to the plane of the bend. Additional material on the sides parallel to the plane of the bend would contribute to the total sound attenuation; but such placement is inefficient because the added material acts only as lining in a straight duct.

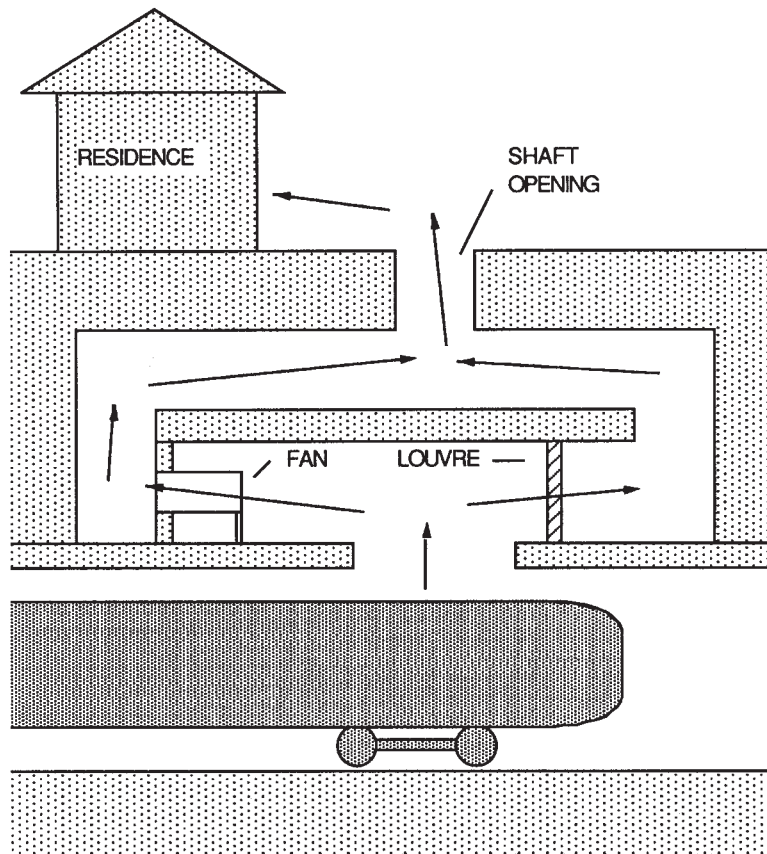

FIGURE 9-9 SKETCH OF SOURCES AND PATHS OF FAN AND VENT SHAFT WHEEL/RAIL NOISE

The maximum attenuation from acoustical absorption treatment placed before or after a right angle bend is accomplished by lining surfaces over the following distances:

- Two shaft depths before or after the bend, if a high absorption lining is used (“thick” treatment),
- Three shaft depths before or after the bend, if a low absorption treatment (“thin” treatment), such as directly applied spray-on materials, is used.

Extending the lining for additional lengths does not appreciably increase sound attenuation. The sides of the shaft parallel to the bend should be lined only if shaft width and depth are comparable. In practice, lining the wall and ceiling areas of a shaft is practical, but lining the floor is not. This restriction means that in some cases, only one side of the duct shaft can be lined, either just before or just after a bend.

Table 9-5 indicates the approximate amount of attenuation that can be achieved by applying either “thick” or “thin” sound absorbing treatment at shaft bends. The “thick” treatment would typically consist of 2-in. thick glass fiber or a spray-on material on metal lath backed by a 1-in. air space. A “thin” treatment would consist of directly applied spray-

on material $\frac{5}{8}$ - to $\frac{3}{4}$ -in. thick without air space. Note that 1-in thick glass wool, applied directly to the concrete surface, would provide absorption and attenuation about halfway between the “thick” and “thin” treatments as described earlier.

The data in Table 9-5 illustrate the effects of lining straight portions of the shafts, as well as the effects of interaction at a bend, and are intended for use with rectangular shafts of a width greater than $2D$. For shafts of width less than $2D$, the sides parallel to the plane of the bend should also be lined. The results apply to round shafts also if the lining on one half the circumference is considered equal to lining on one side of a rectangular shaft, and the lining around the entire circumference equals the lining shown on two sides. In shafts where the available length of straight duct to be lined before or after a bend is less than $1.5D$, attenuation will be less than that given in Table 9-5; in these shafts, other methods of achieving noise reduction may be appropriate.

The attenuations listed in Table 9-5 are equally valid for small, medium, or large shafts. This generalization is possible because shafts are usually designed so that the lining area, as defined by the table, is approximately proportional to the shaft size. For full 180 deg bends in the shaft, the attenuation

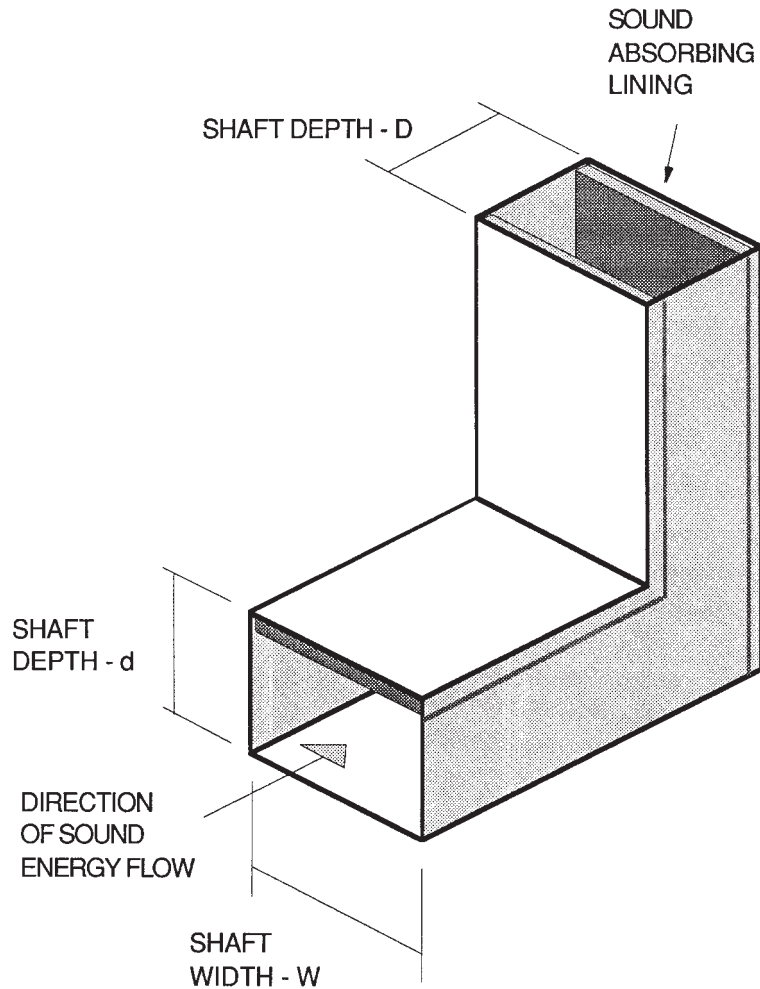

FIGURE 9-10 RIGHT-ANGLE BEND IN DUCT

TABLE 9-5 APPROXIMATE ATTENUATION OF SOUND ACHIEVED BY LINING RIGHT ANGLE BENDS IN FAN AND VENT SHAFTS

LINING LOCATION	SIDES TREATED	LINING AREA		ATTENUATION - dBA	
		THICK TREATMENT ¹	THIN TREATMENT ²	500 HZ	1,000 HZ
AHEAD OF BEND	1	2dW	3dW	2	3
	2	(4d+D)W	(6d+D)W	6	8
AFTER BEND	1	(2D+d)W	(3D+d)W	5	6
	2	(4D+d)W	(6D+d)W	8	10
AHEAD AND AFTER BEND	1 + 1	(2D+3d)W	(3D+4d)W	7	10
	1 + 2	(4D+3d)W	(6D+4d)W	10	14
	2 + 2	(3D+5d)W	(4D+7d)W	11	16

1 "Thick Treatment" consists of 2 in. thick glass fiber or spray-on material on metal laths. Absorption coefficients at 500 Hz and 1,000 Hz of 0.8 to 0.9.

2 "Thin Treatment" consists of 5/8 to 3/4 inch thick spray-on material with absorption coefficients of at least 0.5 at 500 Hz and 0.7 at 1,000 Hz.

obtained by lining the shaft either before or after the bend is approximately 1.5 times that listed in Table 9-5.

The following example illustrates the use of Table 9-5 to estimate the reduction caused by lining a vent shaft. Figure 9-11A indicates a shaft bend, similar to many found in both station and line vent shafts. In this situation, several circumstances prevent the maximum utilization of a lined bend. It is generally impractical to line the floor of a shaft or any area open to the weather; the only remaining area available for treatment is the ceiling before the bend. The 18-ft length of thick treatment on the ceiling, indicated in Figure 9-11A, will give a reduction of only about 3 dB. However, if the shaft is rearranged, as shown in Figure 9-11B, the bend can be lined much more effectively, and the total attenuation will be about 15 dB. The attenuation achieved by lining one side before and one side after the bend is about 10 dB, and the extra attenuation of a 180 deg bend, compared to a 90 deg bend, is 1.5 times 10 dB. Clearly, such alterations will complicate the airflow, and increased flow resistance must be considered.

Vent and fan shaft designs often fail to allow sufficient area for acoustical treatment, and some of the potential attenuation that might be provided by a lined bend cannot be obtained. Although the design attenuation may not be achieved, lining a bend will be more effective than lining a straight shaft with identical treatment. Using half the recommended length of lining on a bend will result in approximately half the attenuation.

9.5.1.3 Plenums

Analyzing the section of shaft illustrated in Figure 9-12 as a large bend, with thick absorption material on the two sides before the bend, gives 8 dB attenuation at 500 and 1,000 Hz. According to the estimates of treatment area given in Table 9-5, 910 sq ft of treatment would be needed. However, the shaft section is more accurately modeled as a plenum than as a lined bend. The formula for noise reduction obtained by lining a plenum is

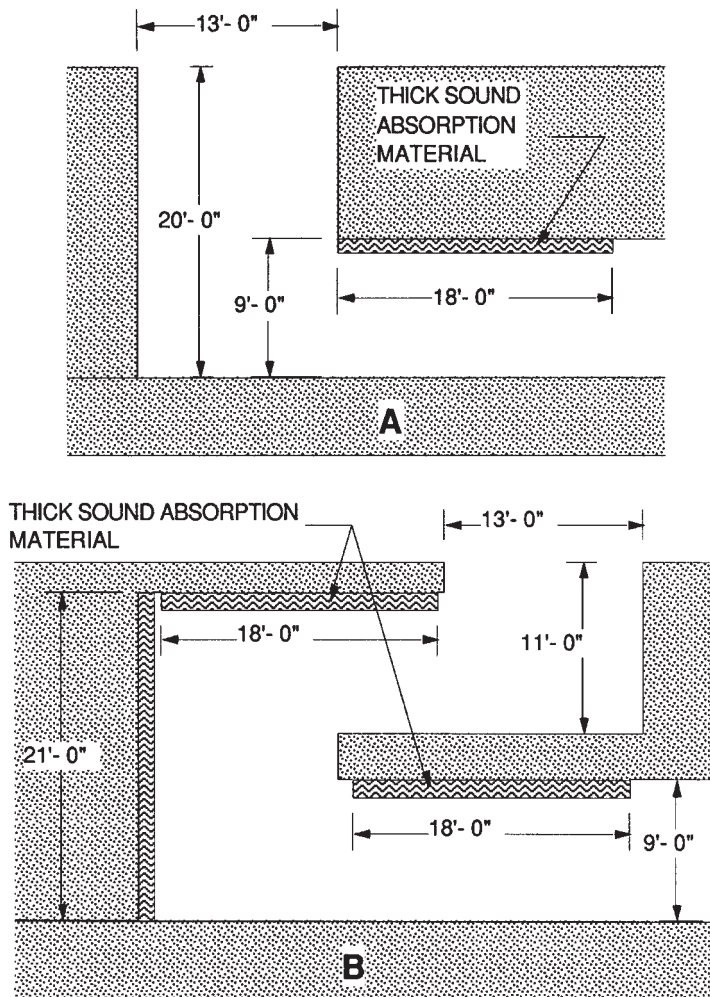

FIGURE 9-11 TYPICAL BEND IN SHAFT

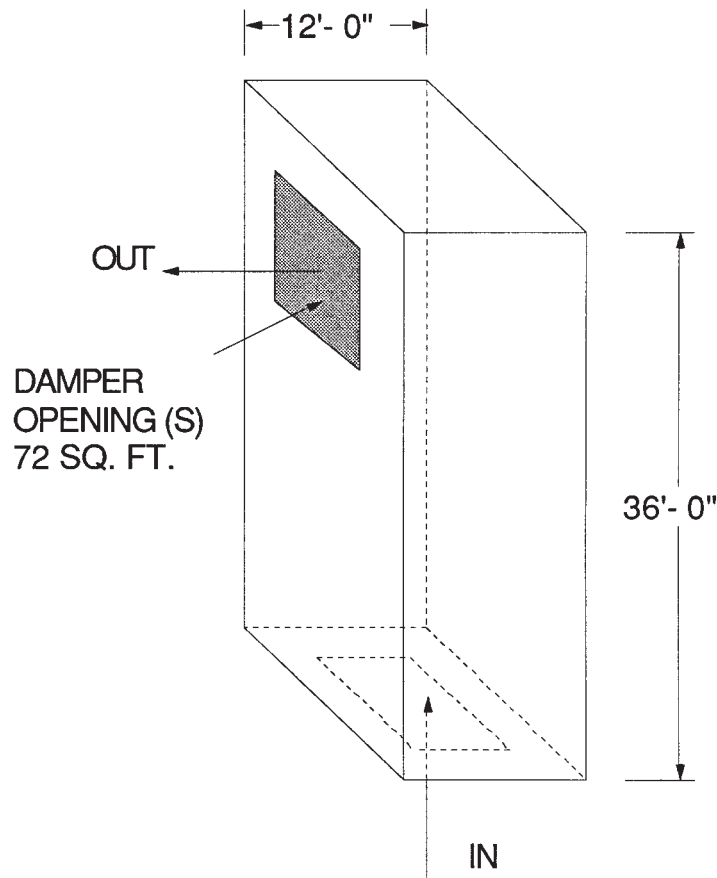

FIGURE 9-12 TYPICAL PLENUM CONFIGURATION

$$\text{Attenuation (dB)} = 10 \log \left[S \left(\frac{\cos(\theta)}{2\pi q^2} + \frac{1-\alpha}{a} \right) \right]$$

where

S = area of outlet, m^2

α = average random-incidence absorption coefficient of plenum, dimensionless

a = total absorption in plenum chamber in sabins, equal to area of treatment times absorption coefficient, m^2

q = diagonal distance between inlet and outlet, m

θ = angle between inlet and outlet, degrees

In the design sketched in Figure 9-12, assuming 910 sq ft of absorptive lining with an absorption coefficient of 0.9, the reduction is 12 dB; 4 dB more than the lined bend estimate. Doubling the treatment area increases the reduction to 15 dB. This formula for attenuation by a lined plenum is accurate within a few decibels at high frequencies where the acoustic wavelength is less than the plenum dimensions. At lower frequencies, the equation is conservative; actual attenuation sometimes exceeds the value calculated by the above equation by 5 to 10 dB, due to sound reflections caused by the expansion at the plenum inlet. The effect is not unlike a tuned muffler.

Whether a section of shaft should be considered as a plenum or a duct is not obvious. Conceptually, a plenum is a large chamber, connected by small openings to two or more ducts. The problem is complicated by the large cross-section area of most fan and vent shafts. A short section, in which the connecting ducts contain significantly smaller cross-sectional areas than the shaft section under analysis, may generally be modeled as a plenum. When the cross-section area is constant through the shaft and the connecting ducts, the lined duct model or lined bend model is more appropriate. There are no simple guidelines to provide for all possible situations. Each shaft configuration must be considered carefully to determine whether the plenum model or the duct model is more appropriate.

9.5.1.4 Vent Shaft Entrances

The subway wall and ceiling at the entrance to the vent shaft is an effective place to add sound absorption. When vent shaft entrances are at the ends of stations, placing sound absorbing materials on the subway walls and ceilings near them provides multiple benefits, including reduction of noise radiated out of vent shafts by as much as 7 dB, platform noise

caused by trains approaching the station, and fan noise transmitted to the stations via the tunnels. Placing special sound absorbing treatment at vent shaft entrances is most effective when the subways do not normally have such treatment. In treated subways, additional treatment in the transition section of the vent shaft is usually only mildly effective; the amount of improvement depends on specific design details.

The added attenuation achieved with a thick absorption treatment on the tunnel walls and ceilings is 5 to 7 dBA, compared to no lining at all. If a thin treatment is used, the expected noise reduction is 3 to 5 dBA at 500 and 1,000 Hz. These figures assume that the walls and ceiling of the subway are lined for 50 ft on each side of the vent shaft entrance. Train noise radiated from the vent shaft can be further reduced by lining the shaft with acoustical absorption, as is discussed in the preceding section.

9.5.1.5 Fan Attenuators

In-line duct silencers installed to reduce fan noise in communities will necessarily reduce wheel/rail noise transmitted through the fan shaft to the community. Attenuators placed to reduce station noise will have no effect on wheel/rail noise transmitted to the station platform area, because the train will be on the same side of the attenuator as the station platform. Many types of silencers are available for installation on ventilation fans. Prefabricated attenuators are available in both rectangular and cylindrical shapes, and either a conical or a round-to-rectangular transition section can be used to couple the silencer to the fan.

In general, the selection of a fan attenuator depends on the amount of attenuation required, which will be determined primarily by the fan sound power, rather than wheel/rail noise. If all required noise reduction is to be provided by the silencer, a unit is needed that provides sufficient attenuation in the 500 Hz and 1,000 Hz octaves. A number of factors should be considered when selecting an appropriate attenuator. The first is whether a rectangular or a cylindrical unit is needed, a choice that will probably be decided on the basis of length and convenience of installation. In general, rectangular units are shorter, and often less expensive, than cylindrical ones. Rectangular attenuators are typically supplied as modules in lengths of 3 ft, 5 ft, 7 ft, or 10 ft. The cross-sectional area depends on the limitations on head loss and face velocity of the airflow through the unit. For subway ventilation fans, round units that give sufficiently low head loss vary from 10 to 16 ft in length. The round units are therefore less desirable, in view of probable space limitations.

After the configuration to be used is selected, the maximum permissible head loss determines the size and type of unit. Rectangular units can provide sufficient noise reduction with satisfactorily low head loss if the appropriate cross-sectional area is selected. For example, rectangular units, ranging from 25 sq ft to 100 sq ft in total cross-sectional area can be obtained with appropriate attenuation ratings and head

loss in the range of 25 to 75 Pa (0.1 in. to 0.3 in. of water) at 60,000 cfm airflow. Rectangular units are probably a better choice, since they are available in relatively short lengths and offer good noise attenuation. A 3-ft length can provide attenuation at 500 Hz in the range of 12 to 26 dB, depending on the head loss rating. At 500 Hz, a 5-ft long unit can provide attenuation in the range of 17 to 37 dB, and a 7-ft long unit can provide attenuation in the range of 23 to 46 dB. The head loss for 60 in. diameter round silencers which could be directly attached to the fans varies from 25 to 100 Pa (0.1 in. to 0.4 in. of water), at 60,000 cfm airflow. Attenuations provided by these silencers vary from 10 to 34 dB. However, the minimum available length is 10 ft, and some units are as long as 15 ft.

The noise reduction rating for a selected attenuator under the design air flow face velocity and volume must be used in design. Although not a general practice, some attenuator catalogs still present sound attenuation data under static conditions. When air is flowing in the same direction as the sound propagation, attenuation will be less than it is under static conditions by a few decibels, depending on flow velocity or volume.

9.5.1.6 Fan Rooms

When a fan room acts as an intake or discharge plenum, significant noise reduction is possible through lining the fan room with acoustical treatment. However, when axial fans are installed within the ductwork, sound-absorbing material in the fan rooms will not reduce the transmission of train noise to the street.

9.5.2 Fan and Vent Shaft Noise Prediction

Train noise radiated from fan and vent shafts can cause annoyance in the community. The noise reaching a receiver position at the surface is dependent upon the sound power emission of the train, which is speed dependent; the sound power transmitted from the subway into the shaft; the attenuation of sound energy as it travels up the shaft to the surface, and, finally, the distance and angle of the receiver relative to the shaft opening. Figure 9-13 illustrates levels of vent shaft noise calculated at the WMATA Metro system.

The sound power transmitted from a subway tunnel into a vent shaft can be approximated as

$$L_w = L_p + 10 \log(A_s) - 6 \text{ dB}$$

where

L_p = sound level in the tunnel when the train is passing the vent shaft

A_s = area of shaft opening, in m^2

L_w = sound power level transmitted into the shaft, dB re 10^{-12} watts

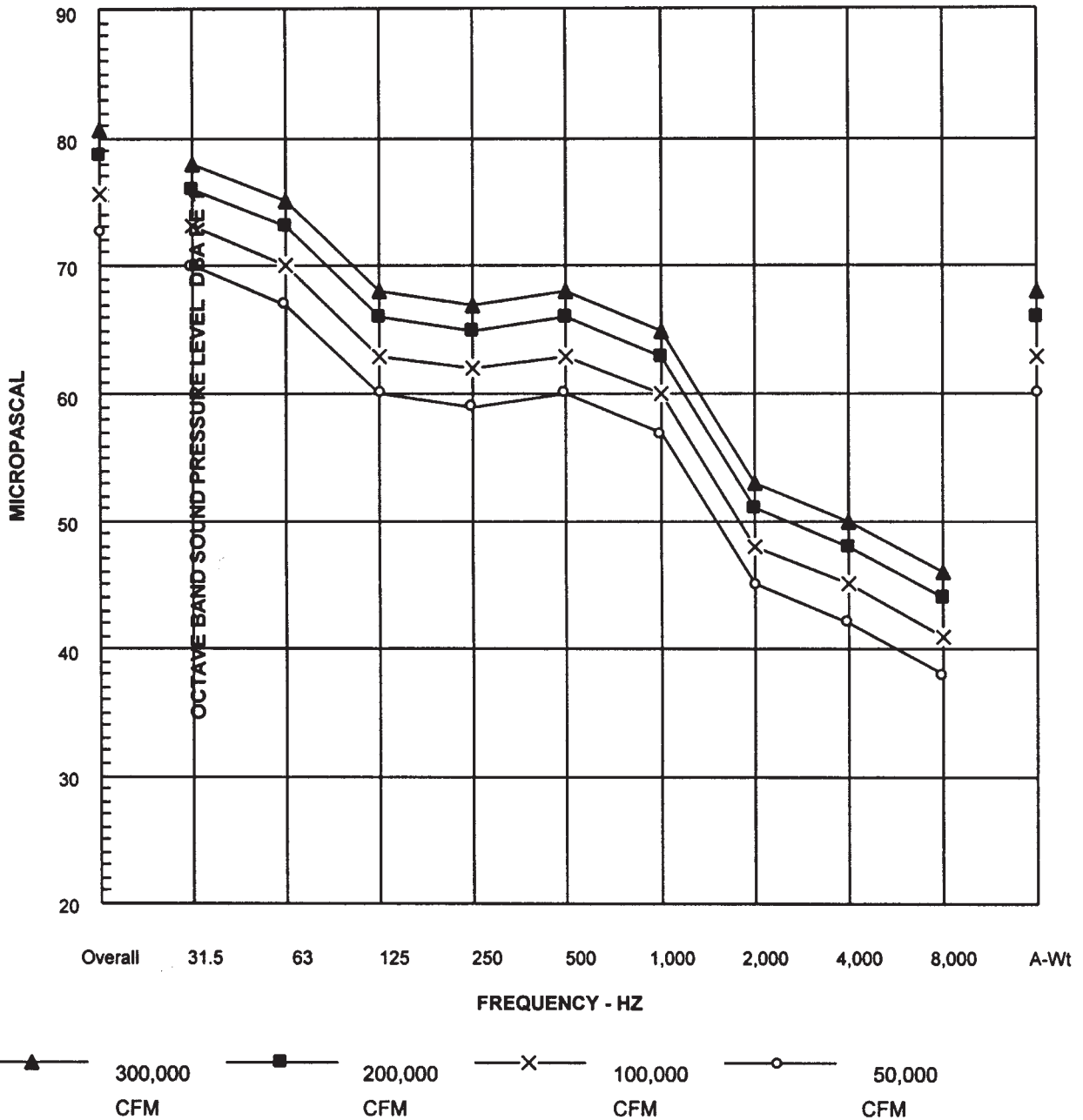

FIGURE 9-13 WMATA DESIGN CURVES FOR MAXIMUM EXPECTED TRAIN NOISE AT 30 FEET FROM SHAFT GRATINGS

The sound level reaching a receiver near the shaft opening and the required sound attenuation can then be estimated in the same manner as for fan noise. The sound level at receiver locations is given by

$$L_{pq} = L_{WR} + DI_q - 20 \text{ Log}(r) - 8 \text{ dB}$$

where

L_{pq} = Sound pressure level measured at distance r and angle q from the source, dB re 1 micro-Pascal.

DI_q = Directivity Index

r = Distance from the shaft center

L_{WR} = Radiated sound power

The radiated sound power is simply the input sound power level, L_W , reduced by the shaft attenuation. In an untreated concrete shaft, a maximum of 2 to 3 dB attenuation may exist, but most of the available sound power is radiated to the community.

Measured directivity factors are presented in Figure 9-14. The directivity index increases as the angle above the horizon increases. From these results, the noise level at a receiver can be obtained.

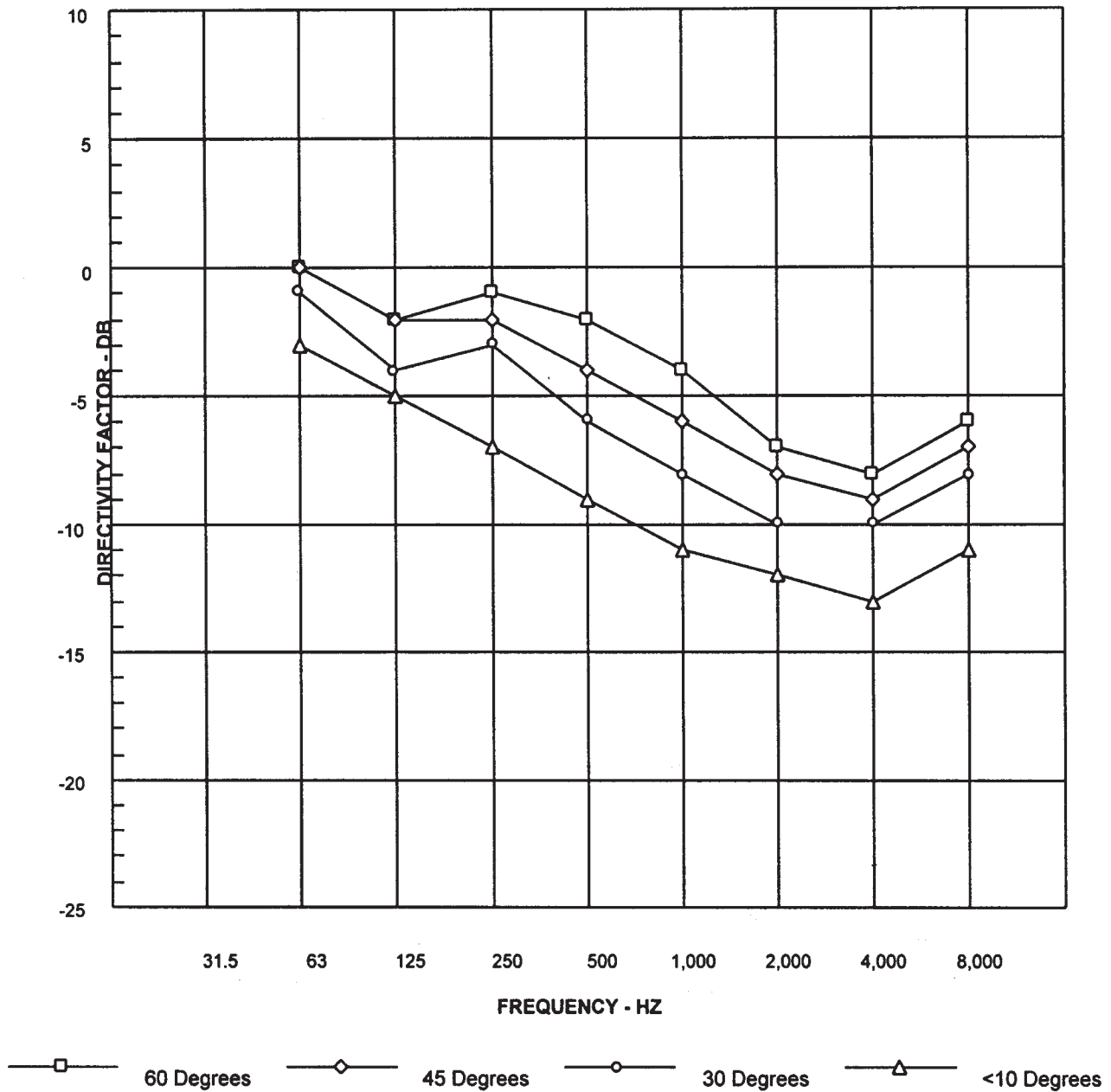

FIGURE 9-14 MEASURED DIRECTIVITY FACTORS FOR VARIOUS ANGLES ABOVE THE HORIZONTAL LINE

9.5.3 Sound Absorbing Materials

Sound absorbing materials used for treating vent and fan shaft surfaces must be durable and economical, and must provide extremely efficient sound absorption in the frequency range covered by the 500 and 1,000 Hz octave bands. The efficiency of sound absorbing materials is measured in terms of the Noise Reduction Coefficient (NRC), which is the arithmetic average of the absorption coefficient at 250, 500, 1,000, and 2,000 Hz. However, because wheel/rail noise is most significant at 500 and 1,000 Hz., the absorption coefficients at these frequencies should be

used. Most of the concern is over rolling noise. If wheel squeal is of concern, then absorption coefficients at 2,000 and 4,000 Hz should also be considered, though materials exhibiting good absorption properties at 500 and 1,000 Hz will normally be very effective at higher frequencies. Materials of similar NRC's may perform differently from one another at specific frequencies.

Three kinds of sound absorbing materials are available for treating fan and vent shaft walls and ceilings:

- Spray-on materials cementitious materials, such as those appropriate for use on subway walls.

- Conventional glass-fiber boards or blankets, mechanically attached to the fan and vent shaft interior surfaces.
- Cellular glass blocks, mechanically attached or adhered to walls.

9.5.3.1 *Spray-On Materials*

Spray-on materials are the easiest to install, and may be cheaper than glass-fiber materials. The number of satisfactory spray-on products is much more limited than glass-fiber blanket or board materials. Many spray-on materials either provide very little sound absorption, or are not durable enough for use in subway fan and vent shaft installations. Those considered effective based on reported transit agency experience include, but are not limited to

- Cafco “Sound Shield 85,” supplied by the United States Mineral Products Company, Stanhope, New Jersey.
- “Kilnoise Acoustic Plaster,” supplied by Pfizer Minerals, Pigments & Metals Division, New York.
- “Pyrok,” supplied by Pyrok Company, New York.
- “Pyro-Spray,” supplied by Baldwin-Ehret-Hill, Inc., Trenton, New Jersey.

All of these materials have similar absorption characteristics when applied in thicknesses of $\frac{5}{8}$ to $\frac{3}{4}$ in. When properly installed, all are durable enough to withstand repeated cleaning or washing with water spray. The installation procedures must be clearly defined and monitored to ensure a durable application. Improper installation may result in inadequate acoustical performance and poor adhesion to surfaces.

Spray-on material applied to fan and vent shaft surfaces in thicknesses of $\frac{3}{8}$ in. to $\frac{3}{4}$ in. will provide absorption coefficients of 0.45 to 0.55 at 500 Hz and 0.70 to 0.80 at 1,000 Hz. Reported absorption coefficients for 1-in. thick treatment applied directly to a concrete surface include 0.24 and 0.42 at 500 and 1,000 Hz, respectively. Evaluation of the initial installations at WMATA subways confirmed that these figures are reasonably accurate. The measured values for 1-in. thick treatment were 0.17 and 0.39 at 500 and 1,000 Hz, respectively (22). Although these figures are less than those reported by the manufacturer for laboratory test results, they are still sufficient to provide significant noise reduction.

9.5.3.2 *Glass-Fiber Boards and Blankets*

Glass-fiber boards or blankets provide the highest sound absorption coefficient, and, therefore, the highest sound absorption for the amount of area covered. A wide range of glass-fiber blanket and board materials will satisfactorily control fan and vent shaft noise. The materials should have a density of 1.5 to 6 pcf, with or without sprayed on vinyl or neoprene protective coating. The most economical and

appropriate material is glass-fiber duct liner, as used in ventilation system ducts. This material is generally available in 1-in. thickness; two layers can be used to obtain a 2-in. thickness. Materials for sound absorption treatment include Owens-Corning Fiberglass rigid or semirigid board. Johns-Manville and Certain-Teed/St. Gobain (Gustin-Bacon) supply similar material, with equivalent mechanical and acoustical characteristics.

Where mechanical protection of the material is necessary, the installation may include an outer covering of acoustically transparent hardware cloth or expanded metal. Dust or dirt collecting on the surface of the glass fiber will not significantly affect its sound absorption characteristics, although dust can be a fire or smoke hazard. Water has no permanent degrading effect on the sound absorbing ability of glass fiber, but absorption is reduced while the material is wet. Over the course of time, the detergents used in tunnel washing may leave an accumulation of residue, the effects of which are not yet known.

Glass-fiber material can be kept from collecting dirt and absorbing water by enclosing it in an envelope of Tedlar of thickness no greater than 0.003 in. Any plastic film with a thickness of 0.004 in. or less is acoustically satisfactory if its weight is less than about 0.3 oz/sq ft. The selection of plastic film must be based on the life expectancy of the tunnel and the fire resistance of the material. In many outdoor environments, mylar or polyethylene film is used. However, when the fire resistance capacity of these materials is unacceptable, a polyamide film such as DuPont Kapton or any other fire-resistant material should be considered.

A number of procedures can be used to attach glass-fiber boards and blankets to concrete surfaces. In machinery rooms and concrete ducts, “Stic Klips” (similar to large headed nails) can be used, either cast in the concrete or fastened to the concrete with cement or epoxy. The glass-fiber material is impaled on the rod, a washer is placed over the rod, and the rod is bent over the washer to retain the material and any added protective covering. Wood or metal furring strips, attached to the concrete surface, can be used with mechanical fastening to support and retain the glass fiber. An “acoustical stud” or similar shaped metal extrusion can be used to attach 2 in. thick material to concrete walls, without using fasteners that penetrate the glass fiber or protective coating. Such mountings are especially convenient when a waterproof covering is to be used.

Fire safety is a major concern when specifying acoustical treatments for subway applications. A glass fiber with no binder is necessary to achieve an incombustible product. However, very few products are manufactured without binders because glass fiber tends to lose fibers when there is no binder material. Temp-Mat, from Pittsburgh Corning, is one example of a glass-fiber product held together by a mechanical felting process that contains no binder. It does contain a small amount of residual oil, used in the manufac-

turing process, which can be baked out by the manufacturer. It has a density of 11.25 pcf in the 1-in. thickness, which is two or three times the density normally recommended for glass-fiber acoustical absorption. The density of Temp-Mat makes it cost more than lower density materials, but its acoustical performance will be as satisfactory as lower density 6 pcf glass fiber of the same thickness.

9.5.3.3 Cellular Glass Blocks

Geocoustic Blocks, a proprietary product of Pittsburgh Corning, have been used successfully in a number of subway applications. They are made of rigid porous glass foam in thicknesses of 2 and 4 in., and are slotted to increase the effective surface area and absorption. The manufacturer states, and tests confirm, that these blocks have absorption coefficients above 0.90 at 500 and 1,000 Hz. Geocoustic Blocks have the significant advantage of being completely inorganic and incombustible. However, they have the disadvantage of shedding small glass granules. The manufacturer has experimented with a spray-on coating to control the shedding problem, but this adds an organic component to the material that might increase fire-related problems. The Geocoustic Blocks are no longer regularly supplied, though they might be obtained provided sufficient quantities are ordered.

9.6 RECEIVER TREATMENTS

Receiver treatments include improving the sound insulation characteristics of homes or other sensitive structures, usually by retrofitting glazing and doors with acoustically rated units. Receiver treatment has become popular for aircraft noise control, where interior Day Night Levels (L_{dn}) may exceed 45 dBA. Receiver treatment should be considered as the last approach for controlling wheel rail noise, since there are no established criteria for interior noise from rail transit systems, and the interior noise limit of L_{dn} 45 recommended by the Environmental Protection Agency for community noise exposure is not likely to be exceeded by wheel rail noise, provided that the system is in good condition and that receivers are not located within a few feet of the system. A second reason for avoiding receiver treatment is that during the process of retrofitting windows and doors, pest damage and/or code violations may be encountered, the correction of which may require substantially greater funds than needed just for the retrofit. In effect, the transit system may become responsible for the overall improvement of the structure. Nevertheless, the experience obtained with aircraft noise insulation projects may serve as a valuable guide. For those pathological situations where a receiver is located within a feet of the transit system, or where rail corrugation cannot be controlled adequately, and a sound barrier is impractical, treatment of windows and doors remains as a viable option, unless they are already acoustically effective.

The best approach is to replace, where appropriate, an existing window with a complete unit consisting of glass, mullion, weather stripping, and miscellaneous hardware. In newer homes built to thermal insulation code requirements in colder climates, the windows may already be sufficiently effective in controlling interior noise. Often, storm windows and doors are added to existing windows and doors, respectively, to improve the sound insulation properties of these components. The selection of windows or doors should be based on the spectrum and level of wheel/rail noise. Typically, a door or window with a Sound Transmission Class (STC) of 30 should be adequate. Higher STC ratings may be needed if sound levels are particularly high, or involve pure tones due to rail corrugation, or impact noise from special trackwork.

Treatment of residential receivers may require permanent closure of operable windows. This may, in turn, require provision of mechanical ventilation or air conditioning systems, an expense which may greatly increase the cost of mitigation. Further, if not properly selected, mechanical ventilation and air conditioning systems may produce their own noise impacts.

Contrary to popular opinion, typical or common thermal insulating glass consisting of two identical glass layers separated by a $1/4$ - or $1/2$ -in. air space provides poor sound insulation compared to acoustically rated glass. A better approach is to use single layer laminated glass, thermally insulating glass with dissimilar glass thicknesses, or ideally, thermally insulating glass with at least one laminated glass pane. In spite of the poor performance of common thermally insulating glass, the requirements of the mullions and framing for limiting air intrusion are acoustically beneficial, and such installations will generally be superior to simple casement or sash windows regardless of glass characteristics. Again, sealing air leaks in windows or doors is always acoustically beneficial.

9.7 REFERENCES

1. Kurze, U. J., and G. S. Anderson, "Sound Attenuation by Barrier," *Applied Acoustics*, Vol. 4, No. 1 (January 1971).
2. Maekawa, J., Noise Reduction by Screens, *Mem. Fac. Eng.*, Kobe University, 11 (1965).
3. Kurze, U. J., and G. S. Anderson, "Sound Attenuation by Barriers," *Applied Acoustics*, Vol. 4, No. 1 (January 1971).
4. Peters, S., "The Prediction of Railway Noise Profiles," *Journal of Sound and Vibration*, Vol 32, No.1 (January 8, 1974) pp. 87-99.
5. Peters, S., "Prediction of Rail-Wheel Noise from High Speed Trains," *Acoustica*, Vol. 28, No. 6 (June 1973), pp. 318-321.
6. Saurenman, H. J., J. T. Nelson, G. P. Wilson, *Handbook of Urban Rail Noise and Vibration Control*, UMTA-MA-06-0099-82-1 (February 1982).
7. Hanson, C., et al. *Draft Guidance Manual for Transit Noise and Vibration Impact Assessment*, Harris, Miller, Miller, & Hanson, for U.S. DOT/FTA 1990 (Unpublished).

8. *Transit Noise and Vibration Impact Assessment*, Federal Transit Administration, U.S.DOT, Chapter 3 (April 1995).
 9. Towers, D. A., *Noise Barrier Study for the Metropolitan Dade County Rapid Transit System—Phase I*, Bolt Beranek and Newman Inc. Report No. 5677 (1984).
 10. Personal communication from W. F. King III (1995).
 11. Fischer, H. M., “Noise Generation by Railroad Coaches,” *Journal of Sound and Vibration*, Vol. 66, No. 3 (1979), pp. 333–349.
 12. Parent De Curzon, E. and B. Bequet, “Study into Sources of Wagon Noise: Measurement of Sound Energy Generated by Vehicle Bodies and Running Gear,” *Journal of Sound and Vibration*, Vol. 120, No. 2 (1988), pp. 311–320.
 13. Wilson, G. P., *At-Grade and Aerial Stations in Highway Medians*, Wilson, Ihrig & Associates, Inc., prepared for the Washington Metropolitan Area Transit Authority, February 1973.
 14. Wilson, G. P., “Rail Transit System Noise Control,” *Noise-Con 77 Proceedings*, 1977 National Conference on Noise Control Engineering (October 1977).
 15. Wilson, G. P., “Rail Transit System Noise Control,” *Noise-Con 77 Proceedings*, 1977 National Conference on Noise Control Engineering (October 1977).
 16. Wilson, G. P., “Rail Transit System Noise Control,” *Noise-Con 77 Proceedings*, 1977 National Conference on Noise Control Engineering (October 1977).
 17. Wilson, G. P., *Sound Absorption System for Metro Tunnels and Station Platforms*, Wilson, Ihrig & Associates, Inc., prepared for Washington Metropolitan Area Transit Authority (June 1971).
 18. George Paul Wilson, “Rail Transit System Noise Control,” *Noise-Con 77 Proceedings*, 1977 National Conference on Noise Control Engineering (October 1977).
 19. H. J. Saurenman, J. T. Nelson, G. P. Wilson, *Handbook of Urban Rail Noise and Vibration Control*, Wilson, Ihrig & Associates, Inc. For U.S. DOT/UMTA (February 1982) (NTIS No. UMTA-MA-06-0099-82-1) Chapter 9.
 20. H. J. Saurenman, J. T. Nelson, G. P. Wilson, *Handbook of Urban Rail Noise and Vibration Control*, Wilson, Ihrig & Associates, Inc. For U.S. DOT/UMTA, Final Report (February 1982). (NTIS No. UMTA-MA-06-099-82-2) Chapter 10.
 21. *ASHRAE Guide*, American Association of Heating, Refrigeration, and Ventilation Engineers.
 22. Nelson, J. T., and G. P. Wilson, *Metro-rail Operational Sound Level Measurements: Substation Noise Levels*, Preliminary report prepared by Wilson, Ihrig & Associates, Inc. for the Washington Metropolitan Area Transit Authority (June 1979).
-

CHAPTER 10: RAIL CORRUGATION CONTROL

- 10.1 Introduction, 199
- 10.2 Classification of Corrugation, 199
 - 10.2.1 Roaring Rail, or Short Wavelength Corrugation, 199
 - 10.2.1.1 Relation to Rail Support Stiffness, 200
 - 10.2.1.2 Wheel/Rail Dynamic Forces, 201
 - 10.2.1.3 Stick-Slip Wear Mechanism, 201
 - 10.2.1.4 Rail Steels, 203
 - 10.2.1.5 Rail Support Spacing, 203
 - 10.2.2 Rutting Corrugation, 203
 - 10.2.3 Booted Sleeper, 204
 - 10.2.4 Resilient Wheels and Rail Corrugation, 204
- 10.3 Treatment of Rail Corrugation, 204
 - 10.3.1 Rail Grinding, 204
 - 10.3.1.1 Preventive Grinding, 205
 - 10.3.1.2 Profile Grinding, 205
 - 10.3.1.3 Rail Grinding Frequency, 205
 - 10.3.1.4 Grinding Depth, 205
 - 10.3.1.5 Profile, 206
 - 10.3.1.6 Variation of Contact Patch Location, 206
 - 10.3.2 Lubrication, 206
 - 10.3.2.1 Onboard Solid-Stick Flange Lubrication, 206
 - 10.3.2.2 Onboard Solid-Stick Friction Modifiers, 207
 - 10.3.3 Hardfacing, 207
 - 10.3.4 Rail Selection, 207
 - 10.3.5 Rail Support Modulus, 207
 - 10.3.6 Trackwork Resonances, 208
 - 10.3.6.1 Rail Support Spacing, 208
 - 10.3.6.2 Direct Fixation Fastener Mechanical Impedance, 209
 - 10.3.7 Speed Variation, 210
 - 10.3.8 Super-Elevation, 210
- 10.4 References, 210

CHAPTER 10

RAIL CORRUGATION CONTROL

10.1 INTRODUCTION

Rail corrugation causes some of the most serious wheel/rail noise problems experienced by transit systems. The noise is irritating, and can be painful and possibly harmful to patrons in subways. At the wayside, wheel/rail noise due to corrugated rail contains a distinctive tonal character, and the noise may be heard and identified at many miles from the track, especially under certain wind and temperature conditions. While noise from corrugated rail is particularly severe and may be a source of significant community reaction, it is also relatively easily controlled by rail grinding. The only, and not insignificant, limitations are available funding for rail grinding equipment and materials and personnel, and track time for grinding.

Presented below are discussions of the corrugation and possible treatment methods, based on the literature, anecdotal information, and the experience of the authors. Substantial research has been conducted within the last 10 to 15 years which appears to be culminating in a relatively clear picture of various corrugation processes. Particularly relevant is a recent survey of corrugation formation at rail transit systems (1), which provides a comprehensive discussion of rail corrugation formation and track configurations which may contribute to corrugation. A rather thorough review of the literature and state-of-the-art in methods of control has been provided by Grassie and Kalousek (2), who indicate that concern over rail corrugation has existed since the beginning of railroading. In 1961, British Rail had compiled a list of references from the year 1904, and the level of interest and research in the area has not abated.

10.2 CLASSIFICATION OF CORRUGATION

Rail corrugation is defined as a periodic longitudinal rail head profile brought about by either wear or plastic flow of the rail head running surface. Rail corrugation consists of three basic wavelength regimes:

1. "Roaring Rail" corrugations with wavelengths of 1 to 3 in. These are usually associated with light axle load operations such as at transit systems and commuter/passenger operations. The term "short pitch" is synonymous with roaring rail. At BART, roaring rail is also described as "howling rail."
2. Intermediate Wave Corrugations with wavelengths of 6 to 18 in. These are usually associated with heavy-axle-load freight operations and are most frequently found on the low rail of curves.
3. Long-Wave Corrugations with wavelengths greater than 24 in. These are usually associated with high speed passenger operations, but can be found on other low speed track as well.

The above classifications pertain to the phenomenological characteristic which is most readily observed, namely, corrugation wavelength.

Rail corrugation has been classified by Grassie and Kalousek (3) into six categories, including (1) heavy haul, (2) light rail, (3) booted sleeper, (4) contact fatigue, (5) rutting, and (6) roaring rail. The various classifications are listed in Table 10-1.

10.2.1 Roaring Rail, or Short Wavelength Corrugation

Roaring rail or short-pitch corrugation often produces severe noise at moderate to high vehicle speeds, and is often responsible for community noise complaints. Not only is the noise from short-pitch corrugation higher than from rail in smooth condition, but it has a tonal character centered at about 500 to 800 Hz, and is much more easily detected and difficult to ignore than normal rolling noise.

One of the most comprehensive discussions of short wavelength corrugation is provided by C. O. Frederick, Chief Civil Engineer of British Railways Board (4). Several observations are made by Frederick, drawing on the literature and his own work for high speed rail operations in Britain:

1. Corrugation exhibits severe plastic deformation at the crests, and only mild plastic deformation in the troughs.
2. Corrugation is essentially stationary in position. The peaks and troughs do not translate as the wear progresses. The entire rail loses material, and the rate of loss appears to be greater at the trough than at the crest, which process produces the corrugation. For very small wave amplitudes, the rate of corrugation deepening is proportional to the existing depth (leading to an exponential rate of growth with time).

TABLE 10-1 CLASSIFICATION OF RAIL CORRUGATION (3)

	Classifica- tion	Wavelength - mm -	Cause	Effect
1	Heavy Haul	200-300	P2 Resonance	Plastic flow In Troughs
2	Light Rail	500-1500	P2 Resonance	Plastic Bending
3	Booted Sleeper (Stedef, LVT)	45 - 60 (RATP)	Sleeper Resonance	Wear of Troughs from lateral oscillation
		51-57 (Baltimore)	Flexural Resonance of wheel set	Oscillation, plastic flow of peaks
4	Contact Fatigue	150-450	P2 Resonance lateral	Rolling contact fatigue
5	Rutting	50 (light rail)	Torsional resonance of wheel set	Wear of troughs from longitudinal slip oscillation
		200 (RATP)	Peak vertical dynamic force	
		150-450 (FAST)	P2 Resonance	
6	Roaring Rails	25-80	Unknown	Wear of Troughs from longitudinal slip

3. Corrugation waves at the two rails do not appear to be correlated with distance down the track, and do not form an absolutely periodic pattern. (Correlation of corrugation between rails has been observed elsewhere.)
4. Corrugation appears first at the running edge of concrete ties, and not at all on paved track with continuous rail support, indicating that the corrugation is somehow related to the geometry of the rail support (the support stiffness is also different for paved continuous support versus concrete ballast and tie track).
5. Open hearth steel is less prone to corrugate than Acid Bessemer steels. Steels with low resistance to plastic yield form corrugations very slowly, and steels with high resistance to plastic yield form corrugations very rapidly, though an increase in wear resistance helps to slow the rate of corrugation formation.
6. Grinding rails smooth immediately after installation in the track substantially delays corrugation formation. Corrugation reforms quickly after grinding rail that has already been corrugated, and this may be due to residual corrugation. (Residual periodic work hardening would be another factor.)

Moreover, corrugation wavelengths are observed to be largely independent of train speed, indicating that a wavelength fixing mechanism rather than a mechanical resonance frequency fixing mechanism is at work. A geometric fixing mechanism for wavelengths supports the theory of rail corrugation caused by stick-slip or roll-slip. Wear appears as

the principal corrugation mechanism, rather than plastic deformation.

Frederick's observations of short-pitch corrugation phenomena and sensitivity to treatment appear to be supported by others. Following below are discussions of the various parameters that may affect short-pitch corrugation.

10.2.1.1 Relation to Rail Support Stiffness

Short-pitch corrugation is often present at track with relatively stiff rail supports and where rail grinding is not performed regularly. Examples include corrugation at the TTC Scarborough Line with Pandrol plates and Landis elastomer pads. A recent survey of transit system corrugation lists elastomeric direct fixation track as one of several types of track which exhibit a corrugation rate of 40 to 50% of track (5). Although not identified, support stiffness may be the principal parameter responsible for corrugation at direct fixation track.

Older designs of resilient direct fixation fasteners at U.S. transit systems tend to have relatively high stiffness. New transit system track, such as the new BART extensions, WMATA Metro, and Los Angeles Metro, are employing fasteners of generally lower stiffness. In fact, the tendency in direct fixation track design has been toward using progressively softer direct fixation fasteners with each new transit construction. The influence of soft track support stiffnesses has not yet been reflected in surveys of corrugation conducted to date. Daniels indicates a need to

evaluate the influence of track stiffness on rail corrugation formation (6).

Daniels indicates that the rail support modulus did not have a conclusive effect on ballast-and-tie curved track at FAST during heavy railroad tests (7). Where substantial rail corrugation occurs on direct fixation track, relatively stiff track fasteners are involved, though insufficient data are available to draw definite conclusions. Stiff track support is conjectured by some authors to exacerbate the “pinned-pinned” resonance related to the discrete track supports, and reduction of support stiffness might be beneficial in reducing this possible interaction (8).

Reduction of tie-saver pad stiffness to remove coincidence between the rail/tie vertical anti-resonance and wheelset 2nd order bending and torsional vibration modes appears to have been effective at the RATP in reducing or eliminating booted sleeper rail corrugation at 380-m radius curves. This is perhaps the most dramatic demonstration of the rail corrugation control effectiveness by reducing rail support stiffness. A study of two-block tie corrugation at the Baltimore Metro system suggests that reduction of the tie-saver pad stiffness by 50% would be sufficient to control corrugation at curved track (9). However, work by Grassie et al. indicates that reduction of tie pad stiffness at British Rail may not be beneficial, as discussed above (10).

Concrete tie track exhibits corrugation in the range of 6 to 12 in., compared to wood tie and ballast track, where the predominant corrugation wavelength is 12 to 24 in. Computer modeling indicates that contact patch forces on concrete tie track can be reduced dramatically in the range of 200 Hz if relatively soft (1,000,000 lb/in.) pads are used in lieu of stiff (8,000,000 lb/in.) pads (11).

10.2.1.2 Wheel/Rail Dynamic Forces

Corrugations (as well as the other rail surface defects) will generate dynamic wheel/rail interaction forces that are directly dependent on the magnitude of the defect and the speed of the vehicle. The periodic nature of rail corrugation produces an increasing dynamic wheel/rail force of the nature shown in Figure 10-1. As can be seen in this figure, these forces build up to maximum value very quickly, typically within 50 milliseconds (which corresponds to less than 3 ft for a vehicle travelling at 40 mph).

Analysis of these dynamic forces in the vertical plane results in the relationship presented in Figure 10-2 which presents wheel/rail contact force as a function of corrugation depth and frequency (which in turn is a function of vehicle speed and corrugation wavelength). The transit system’s combination of speed and wavelengths (1 to 3 in.) generate corrugation frequencies of 150 Hz and greater (see Figure 10-3). While this does not appear to generate significant dynamic activity for corrugation depths of 0.005 in., deeper corrugations do generate increased dynamic load levels at these high frequencies.

10.2.1.3 Stick-Slip Wear Mechanism

Grassie and Kalousek indicate that roaring rail corrugation is occasioned by high contact forces at the peaks of the corrugation and low contact forces resulting in slip at the troughs. Stick-slip wear as a corrugating mechanism is also supported by Grassie et al. in a mathematical and experimental study of short-pitch corrugation (12). Creep is predicted at corrugation valleys due to an out-of-phase relationship between wheel/rail contact force and rail profile over a

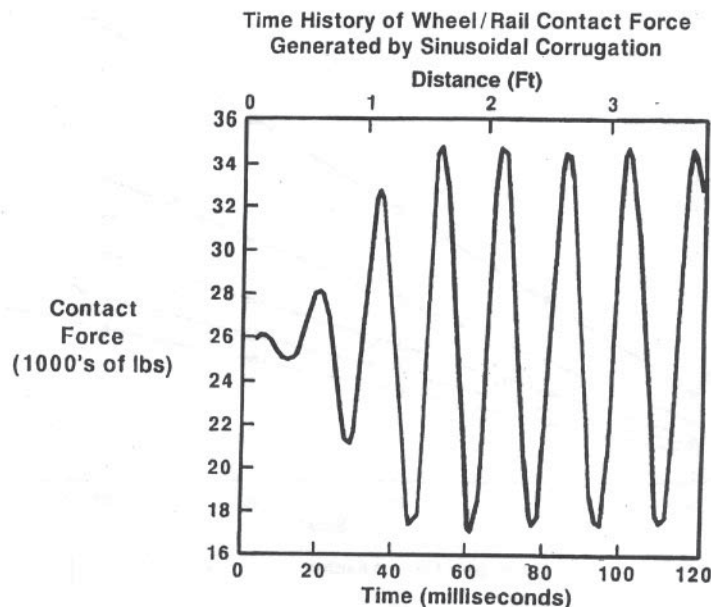

FIGURE 10-1 WHEEL/RAIL CONTACT FORCE VERSUS TIME

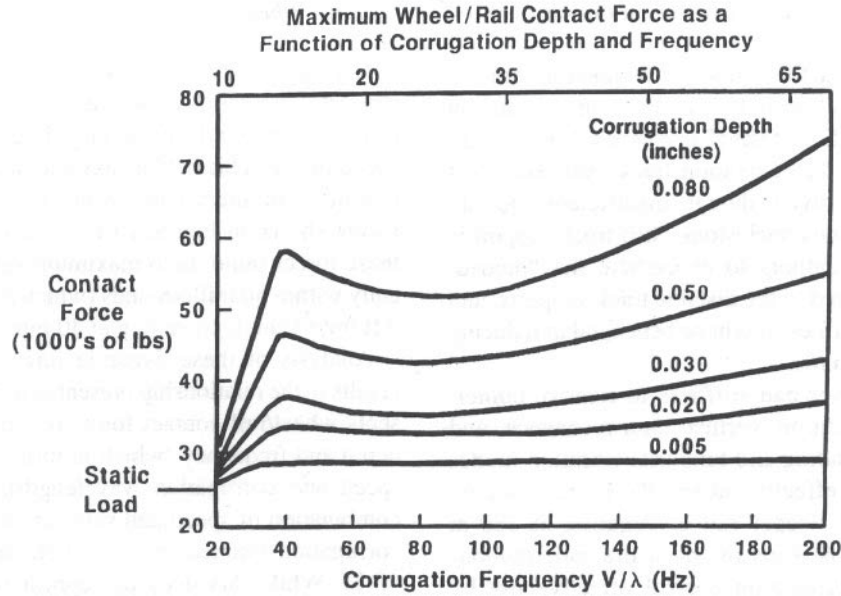

FIGURE 10-2 WHEEL/RAIL FORCE VERSUS CORRUGATION AMPLITUDE AND FREQUENCY

broad frequency range above roughly 500 Hz, not necessarily involving a resonance condition. The contact force is at a minimum at corrugation troughs, allowing longitudinal (and lateral) slip to occur, and thus wear. The results are consistent with wear patterns observed at short-pitch corrugated tracks. These authors further indicate that rail pad resonance

does not appear to contribute to short-pitch corrugation, and that reduction of rail pad stiffness will not significantly reduce corrugation rates. This conclusion differs from that of Daniels, who has suggested reducing pad stiffness at Baltimore MTA to reduce corrugation in connection with the two-block booted ties (13).

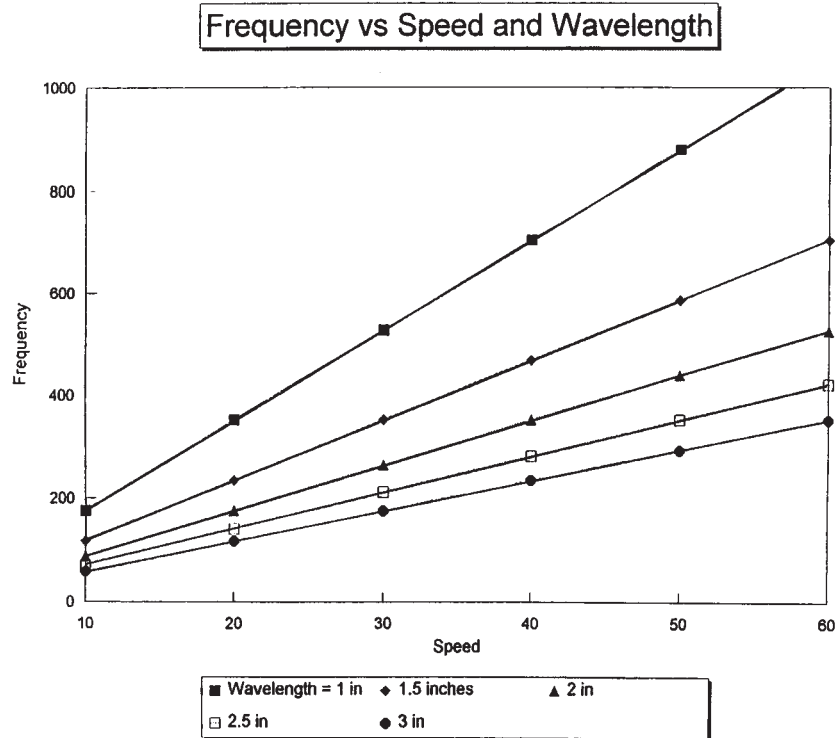

FIGURE 10-3 EFFECT OF TRAIN SPEED AND CORRUGATION WAVELENGTH ON CORRUGATION FREQUENCY

“Roll-slip” behavior (14) has been identified by Kalousek and Johnson at the Vancouver Skytrain (15), and they have further identified a possible relationship between spin-creep and rail corrugation, brought on by wide contact band, high tread conicity, and high wheel/rail conformity due to tread wear. High wheel/rail conformity evidently leads to high-frequency local oscillations at about 800 Hz involving rotation and translation of the rail, producing short-wavelength corrugations. These are “aggravated” by a small amount of lateral slip (16). However, at BART, substantial short-pitch corrugation occurs on tangent track with cylindrical wheels, suggesting that wheel tread conicity is not necessary for generation of corrugation.

In any rolling motion, creep must occur due to the finite size of the contact patch. The creep may be occasioned by roll-slip behavior, due to decreasing friction with increasing creep. Roll-slip behavior may be determined primarily by geometrical characteristics such as contact patch dimensions, because short-pitch corrugation often has a wavelength that is relatively independent of vehicle speed, as noted by Frederick. If the corrugation wavelength was directly proportional to train speed, then mechanical resonances would be expected to be the sole cause of the corrugation. Of course, constant wavelength as a function of speed is not necessarily the rule, either.

Kalousek indicates that not all wheels nor all sections of track are subject to stick-slip oscillation and corrugation. Further, “saturated” creepage is required to generate stick-slip oscillations, and only each twentieth to fiftieth wheelset would be sufficiently misaligned or have other geometrical inconsistency leading to corrugation. Further, Kalousek indicates that asymmetrically worn wheelsets, or misaligned wheelsets due to inadequate maintenance of the track or vehicle, are prone to excite stick-slip oscillations: “Wheelsets with new wheels or turned wheels, installed in well aligned trucks and negotiating tangent track cannot and will not produce stick-slip oscillation” (17).

10.2.1.4 Rail Steels

Grassie and Kalousek indicate that short wavelength corrugation appears to be more extensive with acid Bessemer than with open hearth rail steels, and appears to be moderate with oxygen rail steels. (This may be a reiteration of Frederick’s comments.) Interestingly, rail hardness does not appear to affect short-pitch corrugation rates, at least at tangent track. However, Daniels reports that corrugation rates at curved track with hardened or alloy steel rail are roughly half those of carbon steel rail (18).

10.2.1.5 Rail Support Spacing

The corrugation amplitude appears to be modulated at a spatial wavelength corresponding to tie spacing, with the more severe corrugation on the approach to the ties than between in

the case of resiliently supported ties (19). This effect may be related to so-called “pinned-pinned” resonances of the rail at frequencies of about 350 and 800 Hz. The discrete track supports tend to inhibit motion of the rail, thus creating the pinned-pinned resonance. The associated wavelength of rail vibration is twice the support spacing, considering the rail to be simply supported at the fasteners, hence the term “pinned-pinned.” Theoretical studies support this mode of vibration in modulating the amplitude of corrugation (20).

The pinned-pinned resonance frequency for vertical motion of the rail is between 500 and 750 Hz for fastener spacings on the order of 30 to 36 in., based on a model of beam bending and accounting for rotary inertia and transverse shear. This is *precisely* the range of corrugation frequencies observed at many transit systems. By reducing the fastener spacing to 24 in., the pinned-pinned mode frequency would be increased to the order of 1,000 Hz, sufficiently high to produce a wavelength of about twice the contact patch length, or about 1¼ in. for 70 mph trains. Corrugation waves less than twice the contact patch length might reasonably be expected to be smoothed by the contact patch, though this has not been demonstrated. However, corrugation wavelengths of less than 1 in. or 1¼ in. do not appear to exist. Note that this type of corrugation generation is at odds with the notion of geometrical causes producing stick-slip, so that considerable study is required before excessive support spacing can be blamed for rail corrugation.

Models predict reduced corrugation rates for wear-induced corrugation at tangent track, e.g., “roaring rail,” with reduced rail support modulus and tie spacing. Again, the fixative agents appear to be the rail/tie and the “pinned-pinned” anti-resonance frequencies. Reduction of tie pad stiffness from 770 MN/m to 280 MN/m lowered a 400 Hz anti-resonance of the tie and rail and effectively removed predicted rail corrugation with a wavelength of 9 cm. However, the pinned-pinned mode remains, producing a predicted corrugation at about 3 cm wavelength. Reducing the tie spacing from 600 mm to 400 mm and reducing the pad stiffness to compensate for closer tie spacing raises the pinned-pinned mode anti-resonance from about 1,200 Hz to 2,000 Hz, at which frequency the predicted corrugation wavelength is reduced to 1.7 cm, sufficient, possibly, to be suppressed by the contact patch size (or filter.) No corroborating field data are available (21).

10.2.2 Rutting Corrugation

Rutting corrugation, the 5th form of corrugation identified by Grassie, is produced by windup and torsional resonance of the axle. Grassie and Kalousek indicate that rutting corrugation may occur at curves, braking sites and termini, and where both wheel sets are constrained by coupling to the same truck motor, as with mono-motor trucks. Cures for rutting corrugation include lubrication of the high rail gauge corner, use of hard rails, possibly use of a friction modifier, and avoidance of mono-motor trucks (22).

A particularly interesting study of torsional resonance induced corrugation indicates that two corrugation wavelengths may be generated, one exactly twice the other (23). This phenomenon was observed in the FAST test data collected at the Pueblo, Colorado, Transportation Test Center (24). The mechanism evidently involves cyclic slip in both the forward and reverse longitudinal directions, and applies mainly to curves.

10.2.3 Booted Sleeper

This type of corrugation is related to a resonance condition between the rail and resiliently supported concrete ties, controlled by the high stiffness of the resilient “tie-saver” pad. A coincidence between the rail/tie resonance, axle bending mode, and wheel torsional resonance is a possible cause, leading to corrugation frequencies on the order of 250 to 400 Hz, well within the range of significance to wheel/rail noise (25). A similar relationship between rail and concrete tie was investigated at the Baltimore MTA system (26). This type of corrugation is evidently unique to this two-block tie system. Reduction of pad stiffness (by a substantial amount) evidently eliminates this form of corrugation at the RATP (27), and a similar modification was proposed for the Baltimore MTA by Daniels.

Booted sleeper corrugation, if significant, is particularly important, given the popularity of the two-block tie system as a vibration isolation provision. Installations include MARTA, Baltimore MTA, Tri-Met, the Channel Tunnel, Paris Metro, and elsewhere. Although the two-block tie system provides vibration isolation, corrugation would negate any isolation benefit. The two-block tie concept is not necessarily conducive to corrugation, but certain parameters, such as rail pad stiffness, may be responsible.

10.2.4 Resilient Wheels and Rail Corrugation

A seventh category of rail corrugation may exist. Corrugation of tangent track has been experienced at many light rail systems using resilient wheels. Examples include the Portland Tri-Met, PA Transit in Pittsburgh, Sacramento RTD Metro, the Los Angeles Blue Line ballast-and-tie and direct fixation aerial structure track, Santa Clara Transit Agency, and others. The Greater Cleveland RTA has reported ripple corrugation at station stops for light rail vehicles with resilient wheels, but no corresponding corrugation with heavy rail vehicles with solid wheels (survey questionnaire return). The nature of the corrugation is similar to that of tangent track short-pitch corrugation, and may in fact have identical causes unrelated to wheel resilience.

A periodic pattern has been observed at the rail head at Tri-Met within a few weeks after rail grinding, the pattern being revealed by a variation in moisture at the top-of-rail after passage of a transit train on a damp day (28). The cause of the pattern is not known. The Tri-Met vehicles use Bochum 54 resilient wheels. The periodic pattern is indicative of periodic

motion of the wheel tread, which might result in corrugation over a sufficient period of time.

Corrugation at light rail systems using resilient wheels shows up on both embedded and ballast-and-tie track. Anecdotal evidence suggests that particularly sensitive types of embedded track include urethane embedded track (Portland Tri-Met, Calgary), suggesting that a very high rail support modulus may be a contributing factor, possibly in combination with soft steel girder rail. Some corrugation is also observed at the concrete embedded track in Santa Clara, though reports are mixed. No corrugation appears at the resilient embedded track employed at the Los Angeles Blue Line. Infrequent rail grinding at many light rail systems may be a principal factor in corrugation growth rates at these systems. Further investigation of this phenomenon is necessary to determine the actual influence, if any, of resilient wheels on rail corrugation.

10.3 TREATMENT OF RAIL CORRUGATION

A number of treatments have been proposed for controlling rail corrugation, depending on the type of corrugating mechanism involved.

Short wavelength corrugation was controlled at the Vancouver Skytrain by the following measures (29):

1. Reduction of truck axle misalignment
2. Profile grinding to reduce contact patch width and move the wear strip laterally over different sections of track to avoid rutting of the wheel tread. Reduction of contact patch width is believed to reduce spin-slip motion of the tire. Variation of contact position at the rail head is employed to spread the wear of the tire, further inhibiting formation of tire surface concavity which would increase wheel/rail conformity and thus increase spin-slip.
3. Use of a friction modifier to make the dynamic friction coefficient greater than the static friction coefficient.

The Vancouver system uses a steerable truck and small diameter wheels. However, these procedures should be applicable to conventional heavy and light rail systems. One of the main points of the Vancouver experience is that a combination of treatments or procedures may be necessary to control rail corrugation.

10.3.1 Rail Grinding

Rail grinding is *the most effective control procedure* for rail corrugation and wheel/rail noise in general. Other methods are unpredictable at best, with no guarantee that their implementation will reduce or prevent corrugation. Most modern rail transit systems are actively engaged in rail grinding programs. The RATP regularly grinds corrugated sections of track to control ground vibration (30), which should result in lower levels of wayside and vehicle interior noise.

The Toronto Transit Commission and Chicago CTA regularly grind rail with block grinders to control wheel rail noise and rail corrugation. Examples include the TTC Scarborough SRT, main subway, and light rail systems (survey questionnaire response). Chicago CTA regularly grinds track during revenue hours. BART is engaged in regular rail grinding with a rotary vertical axis grinding machine manufactured by Pandrol-Jackson. WMATA grinds tangent and curved track with a LORAM 24-stone grinder annually or whenever corrugations reach a depth of 0.010 in. Recently, the Los Angeles County Metropolitan Transit Authority has purchased and begun using a Fairmont Tamper vertical axis profile grinder with great success in reducing wayside noise. Rail grinders are increasingly recognized as being essential in any noise control program.

10.3.1.1 Preventive Grinding

Initial rail grinding prior to startup is of great importance to maintain low dynamic contact forces and increase the time before corrugation appears. Rail corrugation was delayed by a period of five years by preventive rail grinding during a study by British Rail (31). The SNCF uses preventive grinding to remove the decarbonized surface layer of the rail head by grinding new rail immediately after laying, taking off 0.30 mm of rail head metal (32). The procedure reduces head checking and fatigue cracking, improves rolling conditions and weld performance, reduces energy consumption, and improves ride comfort.

10.3.1.2 Profile Grinding

Profile grinding to optimize contact patch dimensions, while providing good ride quality characteristics, is desirable to define the contact strip edge and reduce roughness due to variation in rail head ball radius.

10.3.1.3 Rail Grinding Frequency

Finish grinding on a periodic basis controls the formation of corrugation. As pointed out by Frederick, corrugation growth rates are largely exponential in nature. Waiting too long before rail grinding, perhaps until corrugations are “visible,” may allow large corrugations to occur prior to the time grinding can be performed. Thus, grinding is desirable when corrugation development is still on the low end of the “exponential curve.” Grinding off corrugations early maintains an intact work hardened running surface, and “the heat generated by rail grinding slows down the development of corrugations because it reduces internal stresses in the rail head” (33).

An optimum grinding interval can be defined. Assuming that the corrugation growth is exponential in time, and that

the corrugations are entirely removed by grinding, the optimum grinding interval, or *corrugation time constant*, is the time required to grow corrugation amplitudes by 170%. Grinding at longer intervals to completely remove corrugation will result in greater rate of metal removal. Grinding at shorter intervals will result in unnecessarily high expense as well as greater metal removal. Determination of corrugation growth rate is thus of great importance.

The growth rate can be determined by monitoring at various sections of track. The growth rate should be determined by measuring visible growth rates over a defined time interval. Assuming the growth of corrugations is exponential, the amplitude, a , of corrugation varies as

$$a = a_0 \exp(t/\tau)$$

where a_0 is an initial roughness, and τ is the corrugation growth time constant, which is also the optimal grinding interval. If the amplitudes a_1 and a_2 are measured at two respective times t_1 and t_2 , then the corrugation time constant, τ , is given as

$$\tau = (t_2 - t_1) / \ln(a_2/a_1)$$

Subsequent grinding at the optimal time interval may, conceivably, prevent formation of visible corrugation, and waiting for visible corrugation to appear before grinding may be counterproductive.

10.3.1.4 Grinding Depth

The amount of metal removed per pass using an optimum grinding interval might be very slight, much less than normally removed by conventional grinding, and would depend on the residual roughness left after grinding. Rail corrugation will return faster with a rough grind than with a smooth grind, assuming that the wheels are perfectly smooth. If the peak-to-peak amplitude a_0 is the initial roughness of the rail immediately after grinding, then the optimum metal removal would be $2.7 \times a_0$. A reasonable estimate for a_0 is between 300 micro-in. and 1,000 micro-in. for a 1/3-octave band centered at wavenumber 3.7 radians per inch, corresponding to 500 Hz at 50 mph train speed, or a wavelength of 1.7 in. The lower end is for block-ground rail, and the upper end is for MBTA revenue service rail (34). The lower end is probably appropriate for vertical axis rotary stone grinders, except for the grinding pattern that can be introduced into the rail head by the grinding stones, which may be less than an inch in wavelength. This information would suggest that an optimum metal removal per pass would be on the order of 1,000 micro-in., or 1 mil. Because corrugation amplitudes of 1 mil are on the verge of significance, 1 mil would likely be a reasonable amount of metal to be removed per grinding pass.

Again, the minimum grinding interval would be equal to the corrugation growth time constant. If the optimal grinding interval were 1 year, the total metal removed over the course of 30 years would be 30 mils, in addition to normal wear of the rail. This is not a great amount of metal. To contrast this with grinding on a 5-year basis, the amount of metal that would have to be removed every 5 years would be 15 mils, assuming an initial roughness of 300 micro-in. peak-to-peak, and an exponential growth time constant of 1 year. Over a 30-year period, 90 mils of metal would be removed. This is still not a great amount, but the calculation indicates the advantage of using an optimum grinding interval. Second, throughout much of the 30-year period, corrugation noise would be prevalent on a 5-year grinding interval, but non-existent on a 1-year basis. Not only is noise reduced by frequent grinding, but metal removal is minimized.

Grinding on a 5-year grinding interval may also require multiple passes to remove defects and corrugation, followed by profile grinding to re-profile the rail head. Grinding on a 1-year basis would require, perhaps, a single pass per year with a multiple stone grinder to dress the rail without re-profiling.

Data concerning the adequacy of the above approach in defining an optimum grinding interval and metal removal per grind have not been obtained, and research is needed in this area. In practice, removing greater than 1 mil of material may be necessary because of the type of grinding machine involved, in which case the grinding interval might be extended, though at the price of increased noise and metal removal.

Corrugation with amplitude as high as 0.008 in. (0.2 mm) will have already formed hardened martensitic peaks which will require several passes for removal. For rail grinding to be maximally effective, the corrugation must be over-ground by about 0.002 in. (0.05 mm) to remove periodic strength variation between peaks and troughs (35). In contrast, research by Daniels at FAST suggests that grinding should remove visible corrugation, but no more, to prevent rapid return of corrugation at curved track, based on rapid recurrence of rail corrugation after over-grinding by 0.005 in., a relatively small amount. No explanation has been proffered, though the results apply to freight environments (36). Tri-Met has experienced a return of rail corrugation a relatively short time after grinding to remove corrugation with a horizontal axis grinder which does not re-contour the rail head, and may have left unnecessary roughness in the rail head, leading to rapid return of corrugation. The information obtained suggests that once corrugation is established, the cost for corrugation removal and subsequent control in both labor, machines, and rail material removal are expected to be high until periodic internal stresses are controlled.

10.3.1.5 Profile

If the experience at Vancouver Skytrain is a guide, the grinding profile should be such that the contact patch is essentially oval or circular. That is, the longitudinal dimension of the patch should be similar to the transverse dimen-

sion, to reduce unnecessary conformity between the wheel and rail, and thus reduce the propensity for spin-slip of conical wheels. Smith and Kalousek suggest that the rolling radius difference from one side of the contact patch to the other should not exceed 0.5% of the wheel diameter (typically 0.015 in.), which limits conicity and transverse radii of the wheel tire and rail (37). Reduction of the transverse contact patch dimension may result in a slight increase of high frequency noise due to reduction of the contact patch filtering effect, though this slight increase in noise may be minor in comparison to controlling corrugation and "roaring rail." Further, Smith and Kalousek indicate that higher noise levels would occur with a wider contact patch, which increases the contact patch stiffness, contrary to the theory advanced by Remington (38).

Reducing the contact patch transverse dimension may be desirable to control roll-slip behavior of cylindrical wheels as well as conical wheels. If substantial conformity exists between the wheel and rail, due to wear induced concavity of the wheel profile, not only might ride quality suffer, but there would necessarily be creep at the outer edges of the contact patch, due to larger wheel diameter at the outer edges of the contact zone relative to the center of the contact patch zone. This type of creep is referred to as Heathcote slip (39). In this case, roll-slip behavior might also occur due to a negative friction versus creep curve slope. Reduction of the contact patch transverse dimension, and thus wheel/rail conformity, would reduce creep at the lateral edges of the contact patch.

10.3.1.6 Variation of Contact Patch Location

The rail at the Vancouver LRT system was ground to vary the location of the contact patch on the rail head, and thus distribute wear of the tire over a broad running zone to reduce the formation of a rut in the tire, and thus reduce conformity between the rail and tire, and, thus, spin-slip corrugation (40). This approach was employed with steerable trucks of small wheel diameter, and may not be representative of heavy and light rail transit systems.

10.3.2 Lubrication

Lubrication of the high rail has long been known to control corrugation at curved track. However, long wavelength corrugation at short radius curves is not necessarily a wheel rail noise problem, due to the much lower corrugation frequency.

10.3.2.1 Onboard Solid-Stick Flange Lubrication

Metro-Dade County Transit Agency employs a solid-stick lubricant manufactured by Phymet, Inc., applied with onboard spring loaded applicators to control corrugation (41). Flange lubricators used on 75% to 100% of the wheels

appear to reduce corrugation growth rates substantially compared to wayside lubrication (42).

10.3.2.2 Onboard Solid-Stick Friction Modifiers

Friction modifiers reduce negative damping associated with stick-slip oscillation produced by a negative slope of the friction versus creep curve, and may be effective in reducing or eliminating short wavelength corrugation, as suggested by Kalousek and Johnson for the Vancouver Skytrain (43). Several systems are experimenting with dry-stick friction lubricants applied to wheel treads. BART, in particular, has experimented with the Kelsan high positive friction (HPF) friction modifier at the Hayward test track, though the test was not long enough to assess reduction of corrugation rate. Other systems that have experimented with or are using the treatment include the Portland Tri-Met, Los Angeles Blue Line and Green Line, Sacramento RTD Metro, and Metro-Rey in Monterey, Mexico (44). WMATA reports that it uses a Century Oil LCF and KLS Lubriquip Glidemaster solid-stick friction modifiers applied to the wheel flanges. Tests were “discontinued due to noise created by material used. Mounting rattles and material causes squeals” (45). The Los Angeles Blue Line is using the HPF and LCF flange lubricant.

The effectiveness of friction modifiers has been investigated at Sacramento and at the Los Angeles Blue Line. The results of these inspections and measurements are that corrugation is not prevented, nor are sound levels appreciably reduced relative to those at other systems. Corrugation is evident at the Sacramento RTD within 2 years after grinding with a horizontal axis grinder, with attendant roaring rail at short sections of track. Incipient corrugation is observable at the Los Angeles Blue Line 1½ years after grinding, though there may be confusion with a grinding pattern which may have survived over this period of time. Inspection of the aerial structure direct fixation track at the Los Angeles Blue Line reveals corrugation and attendant noise. The Vancouver Skytrain which reports control of rail corrugation by using friction modifiers is also engaged in aggressive rail grinding. The various light rail systems are developing considerable experience with dry-stick friction modifiers, and long-term performance data should be obtainable soon.

10.3.3 Hardfacing

Orgo Thermanite provides materials and services for hardfacing, using a proprietary Reflex alloy which has exceptional hardness characteristics. The material is deposited as a weldment into a routed groove in the rail head. The manufacturer indicates that the treatment is effective because of the hardness of the material. A limitation of Reflex hardfacing is that it may be used only with low carbon steel rail, so that it may not be useable with RE 115 lb/yd rail. This should be checked with the manufacturer.

10.3.4 Rail Selection

Corrugation rates are dependent on the type of rail material and method of manufacture. As discussed above, corrugation rates are evidently higher with Bessemer than with Open Hearth steels (46). Bessemer steels typically have about 1% manganese and 0.6% carbon alloy, while the Open Hearth steel rails have about 0.6 to 0.9% manganese and 0.7 to 0.9% carbon. Daniels indicates that at FAST, the highest corrugation growth rates were obtained with standard carbon steels of Brinell hardness 270 (47). Alloy or heat-treated rails with Brinell hardness between 320 and 360 produced lower rates of corrugation than the standard rails. Heat-treated alloy steels with Brinell hardness in excess of 360 were most resistant to corrugation (48). The information suggests that open hearth steels with hardness in the range of 320 to 360 Brinell would be the best choice for corrugation resistant rails.

10.3.5 Rail Support Modulus

Grassie and Kalousek suggest using soft resilient direct fixation fasteners to reduce wheel/rail contact forces, and reduce possible interaction with the “pinned-pinned” resonance due to tie spacing (49). The worst condition would be rigid supports, which would enforce a complex pinned-pinned mode of vibration at typically 500 to 800 Hz for fastener spacings of 36 and 30 in., respectively. There would exist various pass- and stop-bands for vibration transmission up and down the rail. (A comparison of the input mechanical impedance of the rail head at a location between adjacent fastener supports and over a fastener is presented in Chapter 4 of this manual.) At the other extreme is a completely resilient fastener, which would eliminate resonance of the rail on the fastener as well as the pinned-pinned mode, by decoupling the rail from the trackbed. An unsupported rail would appear as a damped and compliant beam, which might not support formation of rail corrugation. As is well known in the dynamics of beams on elastic foundation, the mechanical input impedance of the beam at frequencies well above the beam-on-foundation resonance frequency is out of phase by 45 deg due to bending wave propagation (50); the result might be a substantial damping effect on wheel and rail vibration. Making the fastener as soft as practical would appear to be appropriate.

Whether or not the pinned-pinned mode is a factor, avoiding a very stiff rail support appears to be desirable to keep the rail on fastener resonance frequency below the range of corrugation frequencies. For fasteners with dynamic stiffness of 2,000,000 lbs/in. at 30-in. spacing, the rail-on-fastener resonance is about 450 Hz. Fasteners of dynamic stiffness on the order of 500,000 lbs/in. would have a rail-on-fastener resonance frequency of about 225 Hz, which is below the range of concern. However, rail corrugation occurs at BART with fastener stiffnesses on the order of 400,000 to 500,000 lbs/in., so that simply reducing fastener stiffness to 500,000 lbs/in. is not the answer.

Recent fasteners procured for BART have a dynamic stiffness on the order of 150,000 lbs/in., giving a rail-on-fastener resonance frequency of about 110 Hz, well below the short-pitch corrugation frequency range. Only time will reveal if using these softer fasteners will reduce corrugation. Other modern transit systems are incorporating relatively soft direct fixation fasteners with stiffness on the order of 100,000 lb/in. or less. Examples include WMATA and LACMTA, where current resilient direct fixation track fastener stiffnesses are on the order of 60,000 to 120,000 lb/in. static and 85 to 170,000 lb/in. dynamic. As experience is gained with these new fasteners, additional evidence will be obtained concerning the effect of track support stiffness on rail corrugation generation and control.

10.3.6 Trackwork Resonances

There are a number of resonances in the track and wheels which may contribute to rail corrugation. These include the pinned-pinned mode resonance of the rail at about 500 to 800 Hz, fastener top plate bending at about 500 Hz and higher frequencies, a radial anti-resonance of the wheel which may occur at about 500 to 1,000 Hz, and lateral bending of the wheel at about 500 Hz. These frequencies are all comparable with short-pitch corrugation frequencies. Without further information concerning the interaction of these vibration modes and anti-resonances, prudent engineering would include separating these resonances in the interest of reducing their possible interaction. Changing the wheel vibration

characteristics is an unlikely avenue, though damping or vibration absorbers might be explored to reduce the effects of resonance and anti-resonances. Increasing the pinned-pinned mode resonance frequency of the rails by decreasing fastener spacing appears to be attractive. Increasing the top plate bending stiffness of resilient direct fixation fasteners to raise their bending resonance frequency in excess of 1,000 Hz is also attractive.

10.3.6.1 Rail Support Spacing

As discussed above, evidence is being collected which suggests that the pinned-pinned mode of rail vibration associated with the finite rail support spacing contributes to rail corrugation. Pinned-pinned modal resonance frequencies for vertical vibration are plotted as a function of fastener spacing in Figure 10-4, based on a bending wave dispersion equation with the effects of rotary inertia and transverse shear included (51). As illustrated in Figure 10-4, a fastener spacing of 30 or 36 in. results in pinned mode resonance frequencies on the order of 500 to 750 Hz, the range of typical corrugation frequencies observed at BART with 36 in. fastener spacing. Further, corrugation amplitudes have been correlated with fastener location, suggesting that the fastener separation does have an effect of some kind.

If the pinned-pinned mode is indeed contributing to rail corrugation, then a possible solution is to reduce the support spacing and/or increase the bending modulus of the rail to increase the pinned-pinned modal frequency sufficiently that

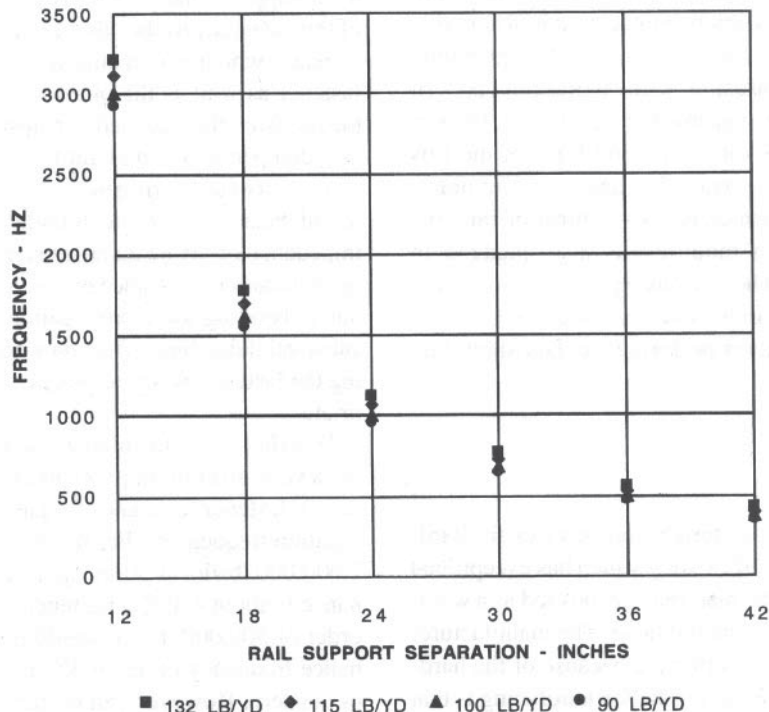

FIGURE 10-4 VERTICAL PINNED-PINNED RESONANCE FREQUENCY VS. RAIL SUPPORT SEPARATION FOR VARIOUS RAILS

the associated corrugation wavelength is less than the contact patch dimension. In this case, corrugations will tend to be “ironed out” or worn away with time. For 70 mph trains with contact patch length of $\frac{5}{8}$ in., the design resonance should be higher than 2,000 Hz, suggesting that the fastener separation should be less than 16 in., a separation which would double the cost of current direct fixation track and is not practical. From a theoretical perspective, the pinned-pinned mode of vibration should not contribute to corrugation if the associated wavelength is less than one half the contact patch length, corresponding to a minimum frequency of about 1,000 Hz, and a minimum fastener spacing of 24 in., though this needs to be verified. Interestingly, the tie spacing of about 24 in. employed at typical ballast-and tie railroad track satisfies this criterion.

Increasing the rail section does not appear to greatly increase the pinned-pinned modal frequency, as illustrated in Figure 10-4. The pinned-pinned resonance frequency does

increase with bending modulus, however, so that heavier rails would be less prone to this possible corrugation mechanism than lighter rail.

An argument against the pinned-pinned resonance influence on rail corrugation is that short-pitch corrugation often exhibits a roughly constant wavelength as a function of train speed, as discussed above, implying a geometrical rather than a mechanical resonance as the cause of the corrugation. There are, however, insufficient data available to exclude the pinned-pinned resonance from the list of possible corrugation wavelength fixing mechanisms.

10.3.6.2 Direct Fixation Fastener Mechanical Impedance

A direct fixation fastener does not appear as a pure spring to the rail, but rather as a complex multi-degree-of-freedom

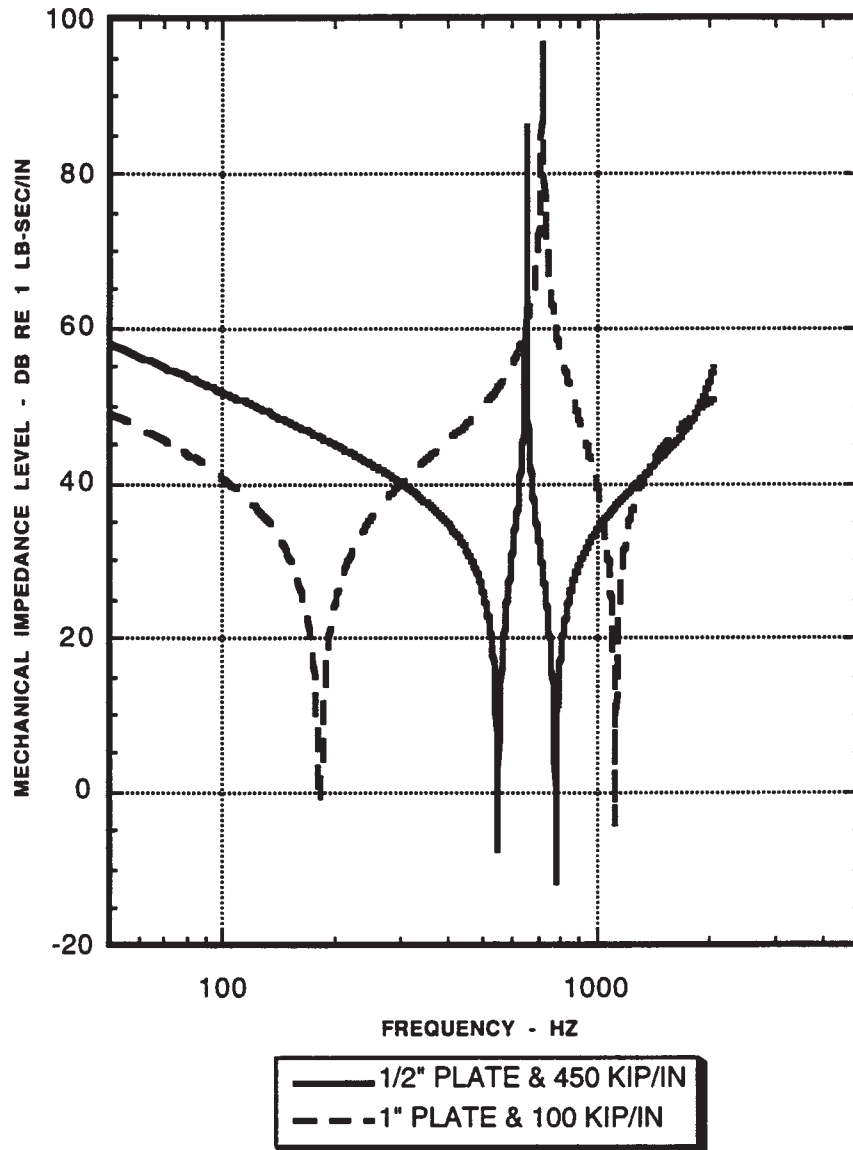

FIGURE 10-5. RAIL FASTENER INPUT MECHANICAL IMPEDANCE.

mechanical element, even when considering only vertical motion. There are two resonances that are particularly interesting. One is the top plate-on-elastomer spring resonance, and the other is the bending resonance of the top plate. The first of these can be thought of as a single-degree-of-freedom oscillator with mass equal to the top plate mass and the spring equal to the stiffness. The second is influenced by the vertical stiffness per unit area of the elastomer. Figure 10-5 illustrates the theoretical input mechanical impedances of two idealized fasteners measuring 8 in. wide by 14 in. long. One of these has a 0.5-in.-thick steel plate supported on ideal springs distributed beneath the fastener with a total dynamic stiffness 450,000 lbs/in. These are typical parameters for relatively stiff fasteners. The second has a 1-in.-thick steel plate supported by ideal springs with total stiffness of 100,000 lbs/in. The fundamental resonance frequency of the top plate vibrating vertically on the elastomer spring is identified by the first dip in the input mechanical impedance curves, which occur at about 550 Hz and 200 Hz for the first and second design configurations, respectively. The effect of bending in the fastener produces an anti-resonance above this resonance, at which frequency the rail would experience an abnormally high reaction to vertical motion. A high reaction by the fastener will tend to “pin” the rail at this frequency, exacerbating the “pinned-pinned” mode, which might contribute to rail corrugation. At higher frequencies a dip occurs in the mechanical input impedance due to a resonance condition of the plate at about 780 Hz and above 1,000 Hz for the first and second design configurations, respectively. The sharp peaks and troughs would normally be smoothed out by damping in the elastomer.

The anti-resonance and resonance frequencies of actual direct fixation fasteners under load are about 500 to 800 Hz, very close to corrugation frequencies for short pitch corrugation. No clear causative relation has been identified between these frequencies and rail corrugation, but prudent design would suggest that they be moved away from corrugation frequencies and modal resonances of the wheels. This can be achieved by thickening the top plate to raise the top plate resonance frequency in excess of 1,000 Hz. Such a fastener has been developed for the BART extensions, and performance of this fastener may be monitored to determine its effectiveness. However, as indicated by Figure 10-5, simply increasing the thickness of the top plate without reducing its mass does not raise the anti-resonance frequency above 1,000 Hz. A ribbed top plate would be most attractive for this purpose. The Cologne Egg type of fastener is of such a design that provides a high top-plate bending stiffness without too severe a mass increase, though the performance characteristics of the Cologne Egg have not been evaluated for this manual.

A most desirable design goal would be to increase the top plate resonance and anti-resonance frequencies such that the associated corrugation wavelength at design train speed would be less than the contact patch length, thus smoothing

out incipient corrugation. For 70 mph trains with contact patch of about $\frac{3}{8}$ in., the corresponding frequency would be about 2,000 Hz, a frequency which may drive the cost and thickness of the top plate. A lower frequency may be adequate. If the associated corrugation wavelength need only be less than twice the contact patch length, then the top plate bending frequency should be greater than 1,000 Hz.

Achieving sufficient top plate stiffness requires a slightly thicker fastener than typical to allow for a thick top plate. A minimum of 2 in. should be made available between the rail base and invert. No other limitation is apparent. An additional advantage is that the elastomer strain can be kept to a practical minimum under static load with a 2-in.-thick fastener, and there should be increased reliability due to the increased strength of the fastener top plate, with less working of the rail clip due to top plate flexure under static load. Thickening the top plate will increase the cost of top plate castings, though the increase should be relatively small in comparison to the overall cost of the fastener. The fastener procurement specification for the BART extensions provides for an overall fastener thickness of 2 in.

10.3.7 Speed Variation

Corrugations at rail transit systems may be exacerbated by uniformity in train speed, vehicle type, and direction. Varying train speed may be beneficial in reducing corrugation growth rates (52).

10.3.8 Super-Elevation

Negative super-elevation imbalance appears to produce higher corrugation rates than no or positive imbalance (53). Super elevation imbalance is defined as the degree of uncompensated imbalance. Thus, a positive super-elevation imbalance exists where the super-elevation is insufficient to counter centripetal forces. A negative super-elevation imbalance exists where the super-elevation is more than adequate to overcome centripetal forces, resulting in a higher vertical load on the low rail than on the high rail. In this case, the low rail is most subject to corrugation. Low rail corrugation is also reported by BART in the survey questionnaire response. Evidently, avoiding negative super-elevation imbalance appears to help control corrugation rates.

10.4 REFERENCES

1. Daniels, L. E. *Rail Transit Corrugations*, Maryland Mass Transit Administration for U.S. DOT/FTA, Final Report, NTIS No. FTA-MD-06-0141-93-1 (December 1993), pp. 2-46.
2. Grassie, S. L., and J. Kalousek, “Rail Corrugation: Characteristics, Causes and Treatments,” *Proc. Instn. Mech. Engrs.* Vol. 207 (1993), pp. 57-68.

3. Grassie, S. L., and J. Kalousek, "Rail Corrugation: Characteristics, Causes and Treatments," *Proc. Instn. Mech. Engrs.* Vol. 207 (1993), p. 58, Table 1.
4. Frederick, C. O., "A Rail Corrugation Theory," *Contact Mechanics and Wear of Rail/Wheel Systems*, II (1987), pp. 181-211.
5. Daniels, L. E. "Rail Transit Corrugations," Final Report, Baltimore Mass Transit Administration, for U.S. DOT/FTA, Report No. FTA-MD-06-0141-93-1 (December 1993), p. 34.
6. Daniels, L. E. *Rail Transit Corrugations*, Final Report, Baltimore Mass Transit Administration, for U.S. DOT/FTA, Report No. FTA-MD-06-0141-93-1 (December 1993), p. xi.
- 7 "Focus on Corrugations," *Progressive Railroading* (Dec. 1985), p. 45.
8. Grassie, S. L., and J. Kalousek, "Rail Corrugation: Characteristics, Causes, and Treatments," *Proc. Instn. Mech. Engrs.*, Vol. 207 (1993), p. 65.
9. Ahlbech, D. R., and Daniels, L. E. "Investigation of Rail Corrugation on the Baltimore Metro," *Wear*, Vol. 144 (1991), pp. 197-210.
10. Grassie, S. L., R. W. Gregory, and K. L. Johnson, "The Dynamic Loading of Rails at Corrugation Frequencies," *Contact Mechanics and Wear of Rail/Wheel Systems*, University of Waterloo Press (1982), pp. 209-228.
11. Zaremski, A. M., G. Izbinsky, S. N. Handal, W. M. Worthington, "Corrugation Behavior in the Freight Railroad Environment," *American Railway Engineering Association, Bulletin* 712, Vol. 88 (October 1987).
12. Grassie, S. L., R. W. Gregory, and K. L. Johnson, "The Dynamic Loading of Rails at Corrugation Frequencies," *Contact Mechanics and Wear of Rail/Wheel Systems*, University of Waterloo Press (1982), pp. 209-228.
13. Daniels, L. E. *Rail Transit Corrugations*, Final Report, Baltimore Mass Transit Administration, for U.S. DOT/FTA, Report No. FTA-MD-06-0141-93-1 (December 1993), p. xi.
14. Grassie, S. L., and J. Kalousek, "Rail Corrugation: Characteristics, Causes and Treatments," *Proc. Instn. Mech. Engrs.* Vol. 207 (1993), p. 64.
15. Kalousek, J., and K. L. Johnson, "An Investigation of Short Pitch Wheel and Rail Corrugations on the Vancouver Mass Transit System," *Proc. Instn. Mech. Engrs.* Vol. 206 (1992), pp. 127-135.
16. Smith, R. E., and J. Kalousek, "A Design Methodology for Wheel and Rail Profiles for Use on Steered Railway Vehicles," *Wear*, Vol. 144 (1991), p. 330.
17. Kalousek, J., *Notes on Wear, Noise and Short Pitch Corrugation Formation in Relation to LCF and HPF Solid Lubricants*, Division of Mechanical Engineering, NRC (This appears to be an unpublished memorandum by J. Kalousek, provided by J. Kalousek to WIA in 1994).
18. Daniels, L. E. *Rail Transit Corrugations*, Final Report, Baltimore Mass Transit Administration, for U.S. DOT/FTA, Report No. FTA-MD-06-0141-93-1 (December 1993), p. 30.
19. Grassie, S. L., and J. Kalousek, "Rail Corrugation: Characteristics, Causes and Treatments," *Proc. Instn. Mech. Engrs.* Vol. 207 (1993), p. 61.
20. Grassie, S. L., R. W. Gregory, and K. L. Johnson, "The Dynamic Loading of Rails at Corrugation Frequencies," *Contact Mechanics and Wear of Rail/Wheel Systems*, University of Waterloo Press (1982), p. 212.
21. Ripke, B. and K. Hempelmann, "Model Prediction of Track Loads and Rail Corrugation," *Railway Gazette International* (July 1994), pp. 447-450.
22. Grassie, S. L., and J. Kalousek, "Rail Corrugation: Characteristics, Causes, and Treatments," *Proc. Instn. Mech. Engrs.*, Vol. 207 (1993), p. 64.
23. Hayes, W. F., and H. G. Tucker, "Wheelset-Track Resonance as a Possible Source of Corrugation Wear," *Wear*, Vol. 144 (1991), 211-226, Figure 2.
- 24 "Focus on Corrugations," *Progressive Railroading* (December 1985), p. 43.
25. Tassily E., and N. Vincent, "Rail Corrugations: Analytical Model and Field Tests," *Wear*, Vol. 144 (1991) p. 173.
26. Ahlbech, D. R. and L. E. Daniels, "Investigation of Rail Corrugations on the Baltimore Metro," *Wear*, Vol. 144 (1991), pp. 197-210.
27. Tassily, E., and N. Vincent, "Rail Corrugations: Analytical Model and Field Tests," *Wear*, Vol. 144 (1991), p. 172.
28. Personal observation by the author.
29. Kalousek, J., and K. L. Johnson, "An Investigation of Short Pitch Wheel and Rail Corrugation on the Vancouver Skytrain Mass Transit System," *Proc. Instn. Mech. Engrs*, Part F, Vol. 206 (F2) (1992), pp. 127-135.
30. Tassily, E. and N. Vincent, "Rail Corrugations: Analytical Model and Field Tests," *Wear*, Vol. 144 (1991), p. 164.
31. Guidat, A. "The Fundamental Benefits of Preventive Rail Grinding," *Rail Engineering International*, No. 1 (Edition 1996), p. 6.
32. Guidat, A. "The Fundamental Benefits of Preventive Rail Grinding," *Rail Engineering International*, No. 1 (Edition 1996), p. 4.
33. Herbst, W., "Subway Rails," *Railroad Track Theory and Practice*, Ed. F. Fastenrath, Trans. Walter Grant, Frederick Ungar Publishing Co., New York, p. 388.
34. P.J. Remington, *Journal of Sound and Vibration*, Vol. 120, n(2) (1988), p. 222.
35. Haess, G. "Measurement of Corrugations and Undulations for Quality Control and For Determining the Most Economical Time for Rail Grinding," *Railroad Track Theory and Practice*, Ed. Fritz Fastenrath, Trans. Walter Grant, Frederick Ungar Publishing Co., New York, p. 308.
36. "Focus on Corrugations," *Progressive Railroading* (Dec. 1985), p. 46.
37. Smith, R. E., and J. Kalousek, "A Design Methodology for Wheel and Rail Profiles for Use on Steered Railway Vehicles," *Wear*, Vol. 144 (1991), pp. 329-342.
38. Remington, P.J. *Wheel Rail Rolling Noise Generation and Control, Report No. 8020*, BBN Systems and Technology for Wilson, Ihrig & Associates, Inc., TCRP Project C3., p. 39. (See Interim Report, Appendix A).
39. Johnson, K. L. *Contact Mechanics*, Cambridge University Press, p. 268-270.
40. Kalousek, J. and K. L. Johnson, "An Investigation of Short Pitch Wheel and Rail Corrugation on the Vancouver Skytrain Mass Transit System," *Proc. Instn. Mech. Engrs*, part F, Vol. 206 (F2) (1992), pp. 127-135.
41. Transit system survey Questionnaire response.
42. Daniels, L. E. *Rail Transit Corrugations* (Final Report), Mass Transit Administration, Baltimore, Maryland, for U.S. DOT/FTA. Report No. FTA-MD-06-0141-93-1 (December 1993), p. 43.

43. Kalousek, J., and K. L. Johnson, "An Investigation of Short Pitch Wheel and Rail Corrugations on the Vancouver Skytrain Mass Transit System," *Proc. Instn. Mech. Engrs.*, Vol. 206 (1992), p. 134.
 44. Personal communication with Kelsan Lubricants, manufacturer of Centrac HPF lubricants (1995).
 45. Transit system questionnaire return.
 46. Grassie, S. L., and J. Kalousek, "Rail Corrugation: Characteristics, Causes, and Treatments," *Proc. Instn. Mech. Engrs.*, Vol. 207 (1993), p. 65. (Grassie et. al., refer to the paper: Pearce, T. G., "The Development of Corrugations in Rails of Acid Bessemer and Open Hearth Steels." Internal memorandum IMDA 257, British Railways Board, August 1976).
 47. "Focus on Corrugations," *Progressive Railroading* (December 1985), p. 45.
 48. Daniels, L. E. *Rail Transit Corrugations* (Final Report), Maryland Mass Transit Administration for U.S. DOT/FTA, Report No. FTA-MD-06-0141-93-1. (December 1993), p. 30.
 49. Grassie, S. L., and J. Kalousek, "Rail Corrugation: Characteristics, Causes and Treatments," *Proc. Instn. Mech. Engrs.*, Vol. 207 (1993), p. 66.
 50. Cremer, L., M. Heckl, *Structure-Borne Sound*, Translated and revised by E. E. Ungar, Springer-Verlag, New York (1973), p. 114.
 51. Cremer and Heckle, *Structure-Borne Sound*.
 52. Ahlbeck, D. R., and L. E. Daniels, "Investigation of Rail Corrugation on the Baltimore Metro," *Wear*, Vol. 144 (1991), pp. 197-210.
 53. Daniels, L. E. *Rail Transit Corrugations* (Final Report), Maryland Mass Transit Administration for U.S. DOT/FTA, Report No. FTA-MD-06-0141-93-1 (1993) p. 28.
-

THE TRANSPORTATION RESEARCH BOARD is a unit of the National Research Council, which serves the National Academy of Sciences and the National Academy of Engineering. It evolved in 1974 from the Highway Research Board, which was established in 1920. The TRB incorporates all former HRB activities and also performs additional functions under a broader scope involving all modes of transportation and the interactions of transportation with society. The Board's purpose is to stimulate research concerning the nature and performance of transportation systems, to disseminate the information that the research produces, and to encourage the application of appropriate research findings. The Board's program is carried out by more than 400 committees, task forces, and panels composed of more than 4,000 administrators, engineers, social scientists, attorneys, educators, and others concerned with transportation; they serve without compensation. The program is supported by state transportation and highway departments, the modal administrations of the U.S. Department of Transportation, and other organizations and individuals interested in the development of transportation.

The National Academy of Sciences is a private, nonprofit, self-perpetuating society of distinguished scholars engaged in scientific and engineering research, dedicated to the furtherance of science and technology and to their use for the general welfare. Upon the authority of the charter granted to it by the Congress in 1863, the Academy has a mandate that requires it to advise the federal government on scientific and technical matters. Dr. Bruce M. Alberts is president of the National Academy of Sciences.

The National Academy of Engineering was established in 1964, under the charter of the National Academy of Sciences, as a parallel organization of outstanding engineers. It is autonomous in its administration and in the selection of its members, sharing with the National Academy of Sciences the responsibility for advising the federal government. The National Academy of Engineering also sponsors engineering programs aimed at meeting national needs, encourages education and research, and recognizes the superior achievements of engineers. Dr. William A. Wulf is president of the National Academy of Engineering.

The Institute of Medicine was established in 1970 by the National Academy of Sciences to secure the services of eminent members of appropriate professions in the examination of policy matters pertaining to the health of the public. The Institute acts under the responsibility given to the National Academy of Sciences by its congressional charter to be an adviser to the federal government and, upon its own initiative, to identify issues of medical care, research, and education. Dr. Kenneth I. Shine is president of the Institute of Medicine.

The National Research Council was organized by the National Academy of Sciences in 1916 to associate the broad community of science and technology with the Academy's purpose of furthering knowledge and advising the federal government. Functioning in accordance with general policies determined by the Academy, the Council has become the principal operating agency of both the National Academy of Sciences and the National Academy of Engineering in providing services to the government, the public, and the scientific and engineering communities. The Council is administered jointly by both Academies and the Institute of Medicine. Dr. Bruce M. Alberts and Dr. William A. Wulf are chairman and vice chairman, respectively, of the National Research Council.

